

TPS2000B Series Digital Storage Oscilloscope User Manual



071-2733-01

Tektronix

**TPS2000B Series
Digital Storage Oscilloscope
User Manual**

Copyright © Tektronix. All rights reserved. Licensed software products are owned by Tektronix or its subsidiaries or suppliers, and are protected by national copyright laws and international treaty provisions.

Tektronix products are covered by U.S. and foreign patents, issued and pending. Information in this publication supersedes that in all previously published material. Specifications and price change privileges reserved.

TEKTRONIX and TEK are registered trademarks of Tektronix, Inc.

OpenChoice and Wavestar are registered trademarks of Tektronix, Inc.

Tektronix is an authorized licensee of the CompactFlash® trademark.

Contacting Tektronix

Tektronix, Inc.
14150 SW Karl Braun Drive
P.O. Box 500
Beaverton, OR 97077
USA

For product information, sales, service, and technical support:

- In North America, call 1-800-833-9200.
- Worldwide, visit www.tektronix.com to find contacts in your area.

Warranty

Tektronix warrants that the product will be free from defects in materials and workmanship for a period of three (3) years from the date of original purchase from an authorized Tektronix distributor. If the product proves defective during this warranty period, Tektronix, at its option, either will repair the defective product without charge for parts and labor, or will provide a replacement in exchange for the defective product. Batteries are excluded from this warranty. Parts, modules and replacement products used by Tektronix for warranty work may be new or reconditioned to like new performance. All replaced parts, modules and products become the property of Tektronix.

In order to obtain service under this warranty, Customer must notify Tektronix of the defect before the expiration of the warranty period and make suitable arrangements for the performance of service. Customer shall be responsible for packaging and shipping the defective product to the service center designated by Tektronix, shipping charges prepaid, and with a copy of customer proof of purchase. Tektronix shall pay for the return of the product to Customer if the shipment is to a location within the country in which the Tektronix service center is located. Customer shall be responsible for paying all shipping charges, duties, taxes, and any other charges for products returned to any other locations.

This warranty shall not apply to any defect, failure or damage caused by improper use or improper or inadequate maintenance and care. Tektronix shall not be obligated to furnish service under this warranty a) to repair damage resulting from attempts by personnel other than Tektronix representatives to install, repair or service the product; b) to repair damage resulting from improper use or connection to incompatible equipment; c) to repair any damage or malfunction caused by the use of non-Tektronix supplies; or d) to service a product that has been modified or integrated with other products when the effect of such modification or integration increases the time or difficulty of servicing the product.

THIS WARRANTY IS GIVEN BY TEKTRONIX WITH RESPECT TO THE PRODUCT IN LIEU OF ANY OTHER WARRANTIES, EXPRESS OR IMPLIED. TEKTRONIX AND ITS VENDORS DISCLAIM ANY IMPLIED WARRANTIES OF MERCHANTABILITY OR FITNESS FOR A PARTICULAR PURPOSE. TEKTRONIX' RESPONSIBILITY TO REPAIR OR REPLACE DEFECTIVE PRODUCTS IS THE SOLE AND EXCLUSIVE REMEDY PROVIDED TO THE CUSTOMER FOR BREACH OF THIS WARRANTY. TEKTRONIX AND ITS VENDORS WILL NOT BE LIABLE FOR ANY INDIRECT, SPECIAL, INCIDENTAL, OR CONSEQUENTIAL DAMAGES IRRESPECTIVE OF WHETHER TEKTRONIX OR THE VENDOR HAS ADVANCE NOTICE OF THE POSSIBILITY OF SUCH DAMAGES.

[W16 – 15AUG04]

Warranty

Tektronix warrants that this product will be free from defects in materials and workmanship for a period of one (1) year from the date of shipment. If any such product proves defective during this warranty period, Tektronix, at its option, either will repair the defective product without charge for parts and labor, or will provide a replacement in exchange for the defective product. Parts, modules and replacement products used by Tektronix for warranty work may be new or reconditioned to like new performance. All replaced parts, modules and products become the property of Tektronix.

In order to obtain service under this warranty, Customer must notify Tektronix of the defect before the expiration of the warranty period and make suitable arrangements for the performance of service. Customer shall be responsible for packaging and shipping the defective product to the service center designated by Tektronix, with shipping charges prepaid. Tektronix shall pay for the return of the product to Customer if the shipment is to a location within the country in which the Tektronix service center is located. Customer shall be responsible for paying all shipping charges, duties, taxes, and any other charges for products returned to any other locations.

This warranty shall not apply to any defect, failure or damage caused by improper use or improper or inadequate maintenance and care. Tektronix shall not be obligated to furnish service under this warranty a) to repair damage resulting from attempts by personnel other than Tektronix representatives to install, repair or service the product; b) to repair damage resulting from improper use or connection to incompatible equipment; c) to repair any damage or malfunction caused by the use of non-Tektronix supplies; or d) to service a product that has been modified or integrated with other products when the effect of such modification or integration increases the time or difficulty of servicing the product.

THIS WARRANTY IS GIVEN BY TEKTRONIX WITH RESPECT TO THE PRODUCT IN LIEU OF ANY OTHER WARRANTIES, EXPRESS OR IMPLIED. TEKTRONIX AND ITS VENDORS DISCLAIM ANY IMPLIED WARRANTIES OF MERCHANTABILITY OR FITNESS FOR A PARTICULAR PURPOSE. TEKTRONIX' RESPONSIBILITY TO REPAIR OR REPLACE DEFECTIVE PRODUCTS IS THE SOLE AND EXCLUSIVE REMEDY PROVIDED TO THE CUSTOMER FOR BREACH OF THIS WARRANTY. TEKTRONIX AND ITS VENDORS WILL NOT BE LIABLE FOR ANY INDIRECT, SPECIAL, INCIDENTAL, OR CONSEQUENTIAL DAMAGES IRRESPECTIVE OF WHETHER TEKTRONIX OR THE VENDOR HAS ADVANCE NOTICE OF THE POSSIBILITY OF SUCH DAMAGES.

[W2 – 15AUG04]

Warranty

Tektronix warrants that the product will be free from defects in materials and workmanship for a period of three (3) months from the date of original purchase from an authorized Tektronix distributor. If the product proves defective during this warranty period, Tektronix, at its option, either will repair the defective product without charge for parts and labor, or will provide a replacement in exchange for the defective product. Batteries are excluded from this warranty. Parts, modules and replacement products used by Tektronix for warranty work may be new or reconditioned to like new performance. All replaced parts, modules and products become the property of Tektronix.

In order to obtain service under this warranty, Customer must notify Tektronix of the defect before the expiration of the warranty period and make suitable arrangements for the performance of service. Customer shall be responsible for packaging and shipping the defective product to the service center designated by Tektronix, shipping charges prepaid, and with a copy of customer proof of purchase. Tektronix shall pay for the return of the product to Customer if the shipment is to a location within the country in which the Tektronix service center is located. Customer shall be responsible for paying all shipping charges, duties, taxes, and any other charges for products returned to any other locations.

This warranty shall not apply to any defect, failure or damage caused by improper use or improper or inadequate maintenance and care. Tektronix shall not be obligated to furnish service under this warranty a) to repair damage resulting from attempts by personnel other than Tektronix representatives to install, repair or service the product; b) to repair damage resulting from improper use or connection to incompatible equipment; c) to repair any damage or malfunction caused by the use of non-Tektronix supplies; or d) to service a product that has been modified or integrated with other products when the effect of such modification or integration increases the time or difficulty of servicing the product.

THIS WARRANTY IS GIVEN BY TEKTRONIX WITH RESPECT TO THE PRODUCT IN LIEU OF ANY OTHER WARRANTIES, EXPRESS OR IMPLIED. TEKTRONIX AND ITS VENDORS DISCLAIM ANY IMPLIED WARRANTIES OF MERCHANTABILITY OR FITNESS FOR A PARTICULAR PURPOSE. TEKTRONIX' RESPONSIBILITY TO REPAIR OR REPLACE DEFECTIVE PRODUCTS IS THE SOLE AND EXCLUSIVE REMEDY PROVIDED TO THE CUSTOMER FOR BREACH OF THIS WARRANTY. TEKTRONIX AND ITS VENDORS WILL NOT BE LIABLE FOR ANY INDIRECT, SPECIAL, INCIDENTAL, OR CONSEQUENTIAL DAMAGES IRRESPECTIVE OF WHETHER TEKTRONIX OR THE VENDOR HAS ADVANCE NOTICE OF THE POSSIBILITY OF SUCH DAMAGES.

[W14 – 15AUG04]

Table of Contents

General safety summary	iv
Compliance Information	vii
EMC Compliance	vii
Safety Compliance	ix
Environmental Considerations	xi
Preface	xiii
Help System	xiv
Conventions	xv
Getting Started	1
General Features	1
Taking Floating Measurements	3
Installation	5
Probes	9
Functional Check	9
Probe Safety	10
Voltage Probe Check Wizard	11
Manual Probe Compensation	11
Voltage Probe Attenuation Setting	12
Current Probe Scaling	13
Self Calibration	13
Operating Basics	15
Display Area	16
Using the Menu System	19
Vertical Controls	21
Horizontal Controls	22
Trigger Controls	23
Menu and Control Buttons	23
Input Connectors	25
Other Front-Panel Items	26
Understanding Oscilloscope Functions	27
Setting Up the Oscilloscope	27
Triggering	28
Acquiring Signals	30
Scaling and Positioning Waveforms	31
Taking Measurements	34
Application Examples	37
Taking Simple Measurements	38
Using Autorange to Examine a Series of Test Points	43
Using an Isolated Channel to Analyze a Differential Communication Signal	44

Viewing a Math Instantaneous Power Waveform	45
Taking Cursor Measurements	46
Analyzing Signal Detail.....	50
Capturing a Single-Shot Signal	51
Measuring Propagation Delay.....	53
Triggering on a Specific Pulse Width.....	54
Triggering on a Video Signal.....	55
Viewing Impedance Changes in a Network.....	59
Math FFT	61
Setting Up the Time-Domain Waveform.....	61
Displaying the FFT Spectrum	64
Selecting an FFT Window	65
Magnifying and Positioning an FFT Spectrum.....	68
Measuring an FFT Spectrum Using Cursors.....	69
Communications (RS-232, Centronics, and RS-232/USB)	71
Sending a Screen Image to an External Device	71
Setting Up and Testing the RS-232 Interface	73
Command Entry.....	78
Setting Up and Using the RS-232/USB Cable.....	79
Removable Mass Storage.....	81
Installing and Removing a CompactFlash (CF) Card.....	81
File Management Conventions.....	82
Using the Save function of the Print Button	83
Managing TPSBAT Battery Packs.....	85
Maintaining Battery Packs.....	86
General Charging Guidelines.....	86
Checking the Charge and Calibration Status.....	87
Charging TPSBAT Battery Packs.....	88
Calibrating Battery Packs.....	90
Handling Battery Packs	91
Storing and Transporting Battery Packs.....	91
Replacing Battery Packs	92
Reference	93
Acquire.....	93
Application	95
Autorange.....	95
Autoset	97
Cursor	100
Default Setup.....	101
Display	101
Help	104

Horizontal.....	104
Math.....	105
Measure.....	107
Print.....	107
Probe Check.....	108
Save/Recall.....	108
Trigger Controls.....	112
Utility.....	118
Vertical Controls.....	120
Appendix A: TPS2000B Specifications.....	123
Oscilloscope Specifications.....	123
Appendix B: TPP0101 and TPP0201 Series 10X Passive Probes Information.....	131
Connecting the Probe to the Oscilloscope.....	131
Compensating the Probe.....	132
Connecting the Probe to the Circuit.....	132
Standard Accessories.....	133
Optional Accessories.....	134
Specifications.....	134
Performance Graphs.....	135
Safety Summary.....	136
Appendix C: Accessories.....	139
Appendix D: Cleaning.....	143
General Care.....	143
Cleaning.....	143
Appendix E: Default Setup.....	145
Appendix F: Font Licenses.....	147
Appendix G: TPS2000B Compatible Probe Maximum Voltages.....	149
Index	

General safety summary

Review the following safety precautions to avoid injury and prevent damage to this product or any products connected to it.

To avoid potential hazards, use this product only as specified.

Only qualified personnel should perform service procedures.

To avoid fire or personal injury

Use proper power cord. Use only the power cord specified for this product and certified for the country of use.

Connect and disconnect properly. Do not connect or disconnect probes or test leads while they are connected to a voltage source.

Connect and disconnect properly. Connect the probe output to the measurement instrument before connecting the probe to the circuit under test. Connect the probe reference lead to the circuit under test before connecting the probe input. Disconnect the probe input and the probe reference lead from the circuit under test before disconnecting the probe from the measurement instrument.

Observe all terminal ratings. To avoid fire or shock hazard, observe all ratings and markings on the product. Consult the product manual for further ratings information before making connections to the product.

Do not apply a potential to any terminal, including the common terminal, that exceeds the maximum rating of that terminal.

Power disconnect. The power cord disconnects the product from the power source. Do not block the power cord; it must remain accessible to the user at all times.

Do not operate without covers. Do not operate this product with covers or panels removed.

Do not operate with suspected failures. If you suspect that there is damage to this product, have it inspected by qualified service personnel.

Avoid exposed circuitry. Do not touch exposed connections and components when power is present.

Replace batteries properly. Replace batteries only with the specified type and rating.

Recharge batteries properly. Recharge batteries for the recommended charge cycle only.

Use proper AC adapter. Use only the AC adapter specified for this product.

Do not operate in wet/damp conditions.

Do not operate in an explosive atmosphere.

Keep product surfaces clean and dry.

Provide proper ventilation. Refer to the manual's installation instructions for details on installing the product so it has proper ventilation.

Terms in this manual These terms may appear in this manual:



WARNING. *Warning statements identify conditions or practices that could result in injury or loss of life.*



CAUTION. *Caution statements identify conditions or practices that could result in damage to this product or other property.*

Symbols and terms on the product

These terms may appear on the product:

- DANGER indicates an injury hazard immediately accessible as you read the marking.
- WARNING indicates an injury hazard not immediately accessible as you read the marking.
- CAUTION indicates a hazard to property including the product.

The following symbol(s) may appear on the product:



Compliance Information

This section lists the EMC (electromagnetic compliance), safety, and environmental standards with which the instrument complies.

EMC Compliance

EC Declaration of Conformity – EMC

Meets intent of Directive 2004/108/EC for Electromagnetic Compatibility. Compliance was demonstrated to the following specifications as listed in the Official Journal of the European Communities:

EN 61326-1:2006, EN 61326-2-1:2006. EMC requirements for electrical equipment for measurement, control, and laboratory use.^{1 2 3}

- CISPR 11:2003. Radiated and conducted emissions, Group 1, Class A
- IEC 61000-4-2:2001. Electrostatic discharge immunity
- IEC 61000-4-3:2002. RF electromagnetic field immunity⁴
- IEC 61000-4-4:2004. Electrical fast transient/burst immunity
- IEC 61000-4-5:2001. Power line surge immunity
- IEC 61000-4-6:2003. Conducted RF immunity⁵
- IEC 61000-4-11:2004. Voltage dips and interruptions immunity⁶

EN 61000-3-2:2006. AC power line harmonic emissions

EN 61000-3-3:1995. Voltage changes, fluctuations, and flicker

European Contact.

Tektronix UK, Ltd.
Western Peninsula
Western Road
Bracknell, RG12 1RF
United Kingdom

- ¹ This product is intended for use in nonresidential areas only. Use in residential areas may cause electromagnetic interference.
- ² Emissions which exceed the levels required by this standard may occur when this equipment is connected to a test object.
- ³ To ensure compliance with the EMC standards listed here, high quality shielded interface cables should be used.
- ⁴ The increase in trace noise while subjected to the test field (3 V/m over the frequency ranges of 80 MHz to 1 GHz and 1.4 GHz to 2.0 GHz, with 80% amplitude modulation at 1 kHz) and (1 V/m over the frequency range of 2.0 GHz to 2.7 GHz, with 80% amplitude modulation at 1 kHz) is not to exceed two major divisions peak-to-peak. Ambient conducted fields may induce triggering when the trigger threshold is offset less than one major division from channel reference.
- ⁵ The increase in trace noise while subjected to the test field (3 V rms over the frequency range of 150 kHz to 80 MHz, with 80% amplitude modulation at 1 kHz) is not to exceed one major division peak-to-peak. Ambient

conducted fields may induce triggering when the trigger threshold is offset less than 0.5 major divisions from channel reference.

- ⁶ Performance Criterion C applied at the 70%/25 cycle Voltage-Dip and the 0%/250 cycle Voltage-Interruption test levels (IEC 61000-4-11).

Australia / New Zealand Declaration of Conformity – EMC

Complies with the EMC provision of the Radiocommunications Act per the following standard, in accordance with ACMA:

- CISPR 11:2003. Radiated and Conducted Emissions, Group 1, Class A, in accordance with EN 61326-1:2006 and EN 61326-2-1:2006.

Safety Compliance

EC Declaration of Conformity – Low Voltage

Compliance was demonstrated to the following specification as listed in the Official Journal of the European Communities:

Low Voltage Directive 2006/95/EC.

- EN 61010-1: 2001. Safety requirements for electrical equipment for measurement control and laboratory use.

U.S. Nationally Recognized Testing Laboratory Listing

- UL 61010-1:2004, 2nd Edition. Standard for electrical measuring and test equipment.

Canadian Certification

- CAN/CSA-C22.2 No. 61010-1:2004. Safety requirements for electrical equipment for measurement, control, and laboratory use. Part 1

Additional Compliances

- IEC 61010-1: 2001. Safety requirements for electrical equipment for measurement, control, and laboratory use.

Equipment Type

Test and measuring equipment.

Pollution Degree Description

A measure of the contaminants that could occur in the environment around and within a product. Typically the internal environment inside a product is considered to be the same as the external. Products should be used only in the environment for which they are rated.

- Pollution Degree 1. No pollution or only dry, nonconductive pollution occurs. Products in this category are generally encapsulated, hermetically sealed, or located in clean rooms.
- Pollution Degree 2. Normally only dry, nonconductive pollution occurs. Occasionally a temporary conductivity that is caused by condensation must be expected. This location is a typical office/home environment. Temporary condensation occurs only when the product is out of service.
- Pollution Degree 3. Conductive pollution, or dry, nonconductive pollution that becomes conductive due to condensation. These are sheltered locations where neither temperature nor humidity is controlled. The area is protected from direct sunshine, rain, or direct wind.
- Pollution Degree 4. Pollution that generates persistent conductivity through conductive dust, rain, or snow. Typical outdoor locations.

Pollution Degree

Pollution Degree 2 (as defined in IEC 61010-1). Note: Rated for indoor use only.

**Installation (Overvoltage)
Category Descriptions**

Terminals on this product may have different installation (overvoltage) category designations. The installation categories are:

- Measurement Category IV. For measurements performed at the source of low-voltage installation.
- Measurement Category III. For measurements performed in the building installation.
- Measurement Category II. For measurements performed on circuits directly connected to the low-voltage installation.
- Measurement Category I. For measurements performed on circuits not directly connected to MAINS.

Overvoltage Category

Overvoltage Category II (as defined in IEC 61010-1)

Environmental Considerations

This section provides information about the environmental impact of the product.

Product End-of-Life Handling

Observe the following guidelines when recycling an instrument or component:

Equipment Recycling. Production of this equipment required the extraction and use of natural resources. The equipment may contain substances that could be harmful to the environment or human health if improperly handled at the product's end of life. In order to avoid release of such substances into the environment and to reduce the use of natural resources, we encourage you to recycle this product in an appropriate system that will ensure that most of the materials are reused or recycled appropriately.



This symbol indicates that this product complies with the applicable European Union requirements according to Directives 2002/96/EC and 2006/66/EC on waste electrical and electronic equipment (WEEE) and batteries. For information about recycling options, check the Support/Service section of the Tektronix Web site (www.tektronix.com).

Battery Recycling. This product contains a lithium ion (Li-ion) rechargeable battery, which must be recycled or disposed of properly.

- Lithium-Ion batteries are subject to disposal and recycling regulations that vary by country and region. Always check and follow your applicable regulations before disposing of any battery. Contact Rechargeable Battery Recycling Corporation (www.rbrc.org) for U.S.A. and Canada, or your local battery recycling organization.
- Many countries prohibit the disposal of waste electronic equipment in standard waste receptacles.
- Place only discharged batteries in a battery collection container. Use electrical tape or other approved covering over the battery connection points to prevent short circuits.

Transporting Batteries

The capacity of the lithium ion rechargeable battery pack in this product is under 100 Wh. The lithium-equivalent content, as defined by the UN Manual of Tests and Criteria Part III Section 38.3, is under 8 g per pack and 1.5 g per individual cell.

- Always check all applicable local, national, and international regulations before transporting a Lithium-Ion battery.
- Transporting an end-of-life, damaged, or recalled battery may, in certain cases, be specifically limited or prohibited.

**Restriction of Hazardous
Substances**

This product has been classified as Monitoring and Control equipment, and is outside the scope of the 2002/95/EC RoHS Directive.

Preface

This manual contains operating information for the TPS2000B Series Digital Storage Oscilloscopes. The manual consists of the following chapters:

- The *Getting Started* chapter briefly describes features of the oscilloscope and provides installation instructions.
- The *Operating Basics* chapter covers operating principles of the oscilloscopes.
- The *Understanding Oscilloscope Functions* chapter describes basic operations and functions of an oscilloscope: setting up the oscilloscope, triggering, acquiring data, scaling and positioning waveforms, and taking measurements.
- The *Application Examples* chapter provides examples on how to solve a variety of measurement problems.
- The *Math FFT* chapter describes how to use the Math Fast Fourier Transform function to convert a time-domain signal into its frequency components (spectrum).
- The *Communications* chapter describes how to set up the RS-232 and Centronics ports to use the oscilloscope with external devices, such as printers and computers.
- The *Removable Mass Storage* chapter describes how to use a CompactFlash card and oscilloscope functions available when a card is in use.
- The *Managing TPSBAT Battery Packs* chapter describes how to use, charge, calibrate, and replace battery packs.
- The *Reference* chapter describes the selections or available range of values for each option.
- The *Appendix A: TPS2000B Specifications* chapter includes electrical, environmental, and physical specifications for the oscilloscope.
- The *Appendix B: TPP0101 and TPP0201 Series Probes Information* chapter includes information on and specifications for the TPP0101 and TPP0201 probes.
- The *Appendix C: Accessories* chapter briefly describes standard and optional accessories.
- The *Appendix D: Cleaning* chapter describes how to take care of the oscilloscope.
- The *Appendix E: Default Setup* chapter contains a list of the menus and controls with the default (factory) settings that are recalled when you push the **Default Setup** front-panel button.

- The *Appendix F: Font Licenses* chapter provides the licenses to use specific Asian fonts.
- The *Appendix G: TPS2000B Compatible Probe Maximum Voltages* chapter lists the maximum voltages of compatible probes.

Help System

The oscilloscope has a Help system with topics that cover all the features of the oscilloscope. You can use the Help system to display several kinds of information:

- General information about understanding and using the oscilloscope, such as Using the Menu System.
- Information about specific menus and controls, such as the Vertical Position Control.
- Advice about problems you may face while using an oscilloscope, such as Reducing Noise.

The Help system provides several ways to find the information you need: context-sensitive help, hyperlinks, and an index.

Context-Sensitive Help

The oscilloscope displays information about the last menu displayed on the screen when you push the **Help** front-panel button. When viewing help topics, an LED lights next to the multipurpose knob to indicate that the knob is active. If the topic uses more than one page, turn the multipurpose knob to move from page to page within the topic.

Hyperlinks

Most of the help topics contain phrases marked with angle brackets, such as <Autoset>. These are links to other topics. Turn the multipurpose knob to move the highlight from one link to another. Push the Show Topic option button to display the topic corresponding to the highlighted link. Push the Back option button to return to the previous topic.

Index

Push the front-panel **Help** button, then push the Index option button. Push the Page Up or Page Down option buttons until you find the index page that contains the topic you want to view. Turn the multipurpose knob to highlight a help topic. Push the Show Topic option button to display the topic.

NOTE. Push the Exit option button or any menu button to remove the Help text from the screen and return to displaying waveforms.

Conventions

This manual uses the following conventions:

- Front-panel buttons, knobs and connectors appear as displayed. For example: **Help**.
- Menu options appear with the first letter of each word in upper case. For example: Peak Detect, Window Zone.

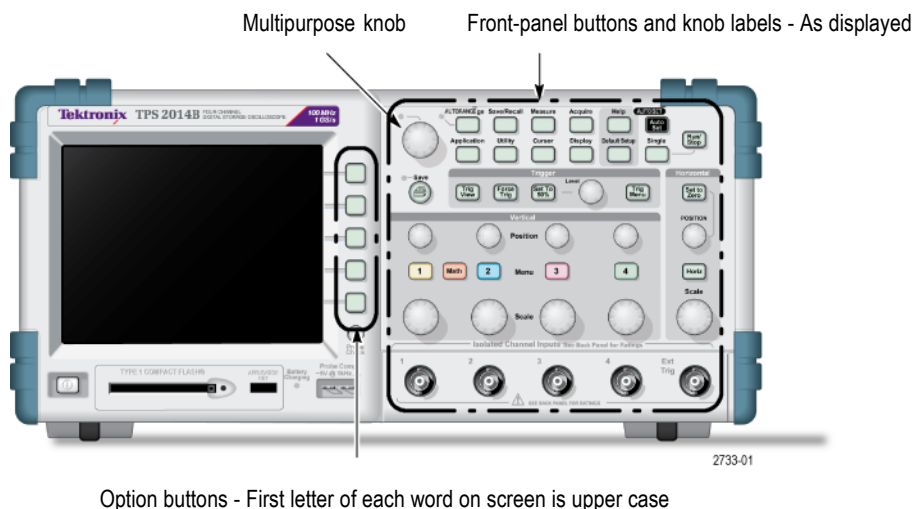

NOTE. Option buttons may also be called screen buttons, side-menu buttons, bezel buttons, or soft keys.

- The ► delimiter separates a series of button pushes. For example, **Utility ► Options ► RS232 Setup** means that you push the **Utility** front-panel button, then push the **Options** option button, and then push the **RS232 Setup** option button. Multiple pushes of an option button may be required to select the desired option.

Getting Started

TPS2000B Series Digital Storage Oscilloscopes are small, lightweight, benchtop instruments, which you can use to take ground-referenced measurements.

This chapter describes how to do the following tasks:

- Take floating measurements
- Install your product
- Charge battery packs
- Perform a brief functional check
- Perform a probe check and compensate probes
- Match your probe attenuation factor
- Use the self calibration routine

NOTE. You can select a language to display on the screen when you power on the oscilloscope. At any time, you can also access the **Utility ► Language** option to select a language.

General Features

The next table and list describe the general features.

Model	Channels	Bandwidth	Sample rate
TPS2012B	2	100 MHz	1.0 GS/s
TPS2014B	4	100 MHz	1.0 GS/s
TPS2024B	4	200 MHz	2.0 GS/s

- Battery powered or line powered
- Two rechargeable battery packs (second battery pack optional)
- Independently isolated channels with no shared common ground
- TPS2PWR1 Power Analysis application (optional)
- Support for compatible voltage probes and current probes
- Context-sensitive help system
- Color LCD display
- Selectable 20 MHz bandwidth limit
- 2500 point record length for each channel
- Autoset

- Autoranging for quick set up and hands-free operation
- Probe Check Wizard
- Cursors with readouts
- Trigger frequency readout
- Eleven automatic measurements
- Waveform averaging and peak detection
- Dual time base
- Math functions: +, -, and \times operations
- Math Fast Fourier Transform (FFT)
- Pulse Width trigger capability
- Video trigger capability with line-selectable triggering
- External trigger
- Setup and waveform storage
- Removable mass storage
- Variable persistence display
- RS-232 and Centronics ports
- OpenChoice PC Communications software
- User interface and help topics in ten languages

Taking Floating Measurements

For taking floating measurements, the oscilloscope channel and Ext Trig inputs ($3\text{ M}\Omega$) are isolated from the oscilloscope chassis and from each other. This allows independent floating measurements with channel 1, channel 2, and Ext Trig (and with channel 3 and channel 4 on four channel models).

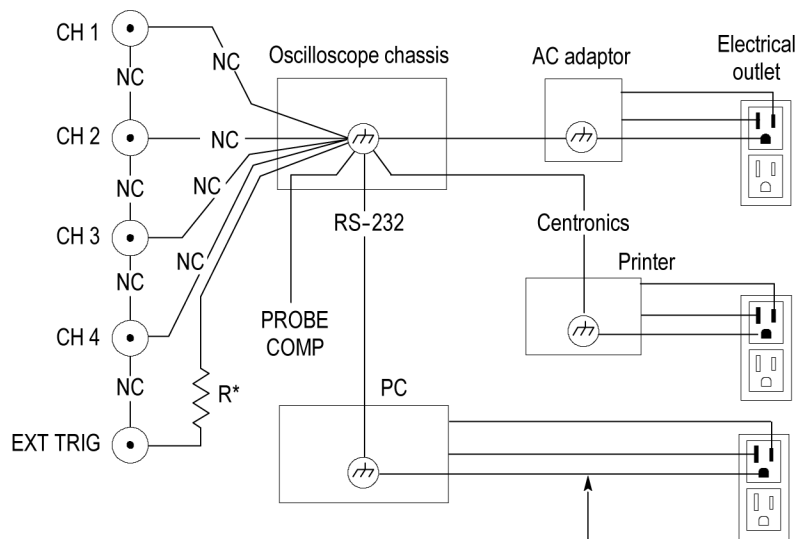

* $3\text{ M}\Omega$ impedance.
NC means not connected.

Connected to earth ground by building wiring,
typical of a North American building.

The oscilloscope inputs float even when the oscilloscope is connected to a grounded power supply, a grounded printer, or a grounded computer.

Most other oscilloscopes share a common reference for the oscilloscope channel and Ext Trig inputs. This reference is typically connected to earth ground through the power cord. With common-referenced oscilloscopes, all input signals must have the same common reference when you take any multi-channel measurements.

Without differential preamplifiers or external signal isolators, common-referenced oscilloscopes are not suitable for taking floating measurements.

Probe Connection



WARNING. To prevent electrical shock, do not exceed the measurement or floating voltage ratings for the oscilloscope input BNC connector, probe tip, or probe reference lead.

Understand the voltage ratings for the probes you are using and do not exceed those ratings. The following voltage ratings are important to know and understand:

- The maximum measurement voltage from the probe tip and BNC signal to the probe reference lead
- The maximum measurement voltage from the probe tip and BNC shell to earth ground
- The maximum floating voltage from the probe reference lead to earth ground



WARNING. *To avoid an electric shock, do not use probes that require a ground connection, such as the Tektronix P5200 High Voltage Differential Probe, with the TPS2000B series oscilloscopes. The P5200 High Voltage Differential Probe requires an oscilloscope with grounded inputs and the TPS2000B series oscilloscopes have floating inputs (isolated inputs).*



WARNING. *Do not float the TPP0101 or TPP0201 probe reference lead to > 30 V_{RMS}. Use the P5120 probe (floatable to 600 V_{RMS} CAT II or 300 V_{RMS} CAT III) or similarly rated, passive, high voltage probe (not the ground referenced P5100 probe), or an appropriately rated, high voltage, differential probe when floating the reference lead above 30 V_{RMS}, subject to the ratings of such high voltage probe.*

To avoid electric shock when using probes with exposed metal parts, do not connect the reference lead to voltages above 30 V_{RMS}.

These voltage ratings depend on the probe and your application. (See page 123, *TPS2000B Specifications*.)

This manual contains more information on probe safety. (See page 10, *Probe Safety*.)

Attach the Reference Leads Correctly

You must attach the probe reference lead for each channel directly to your circuit. These attachments are required because the oscilloscope channels are electrically isolated; they do not share a common connection. Use the shortest possible reference lead with each probe to maintain good signal fidelity.

The probe reference lead presents a higher capacitive load to the circuit under test than the probe tip. When taking a floating measurement between two nodes of a circuit, attach the probe reference lead to the lowest impedance or least dynamic of the two nodes.

BNC Connectors

The oscilloscope BNC reference connection is made on the inside of the BNC connector. The black bayonet on the outside of the BNC connectors does not provide electrical contact. For a good connection, make sure your probe or cable connector is pushed on and twist locked. Replace cables or probes that have worn connectors.

Unterminated BNC Inputs

The black bayonet on the outside of the BNC input connectors does not shield the connector input from unwanted electrical noise from nearby circuits. Connect a 50 Ω terminator or a BNC shorting plug to the input BNC connector when establishing a "No Signal" baseline condition.

Installation

You can use the oscilloscope AC adapter to power the oscilloscope or to charge battery packs when installed. To use the oscilloscope AC adapter as the power source, follow these steps:

1. Insert the DC connector end of the adapter into the DC INPUT connector on the back of the oscilloscope.
2. Connect the appropriate power cord between the oscilloscope AC adapter and an electrical outlet.

If battery packs are installed, an LED lights on the front of the oscilloscope to indicate when the battery packs are charging.

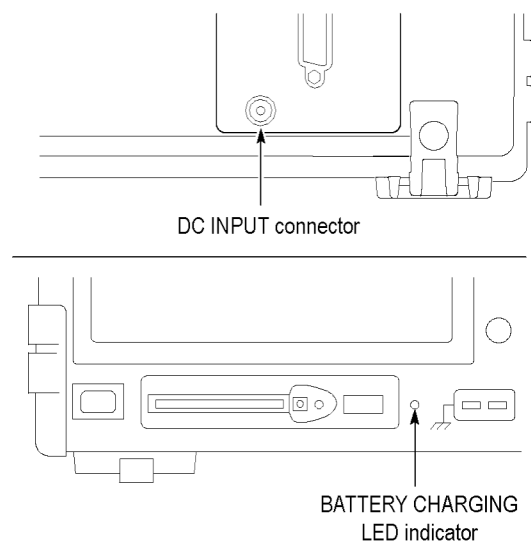

NOTE. *The oscilloscope contains a temperature-sensing fan for cooling that forces air through vents on the bottom and on the side of the oscilloscope. To allow air to flow freely through the oscilloscope, do not block these vents.*

Battery Packs

The oscilloscope can accommodate two TPSBAT battery packs. The product includes one battery pack that is not installed when shipped. The amount of time you can operate the oscilloscope with battery packs depends on the oscilloscope model.

Oscilloscope	Amount of time to operate
2 channel	5.5 hours on one battery pack, 11 hours on two
4 channel	4.5 hours on one battery pack, 9 hours on two

NOTE. The oscilloscope displays a message when approximately 10 minutes of operating time remain on the battery packs.

This manual contains details on how to use, charge, calibrate, and replace battery packs. For example, battery packs need to be calibrated to accurately report available operating time. (See page 85, Managing TPSBAT Battery Packs.)

To install battery packs, follow these steps:

1. Press the battery compartment door latch on the right side panel and open the battery compartment.
2. Orient the battery pack as shown on the oscilloscope, and install the pack. Battery packs are keyed, so you can insert them only one way.

For single battery pack use, install a pack in the lower receptacle. This lowers the center of gravity.

3. Close the battery compartment door.

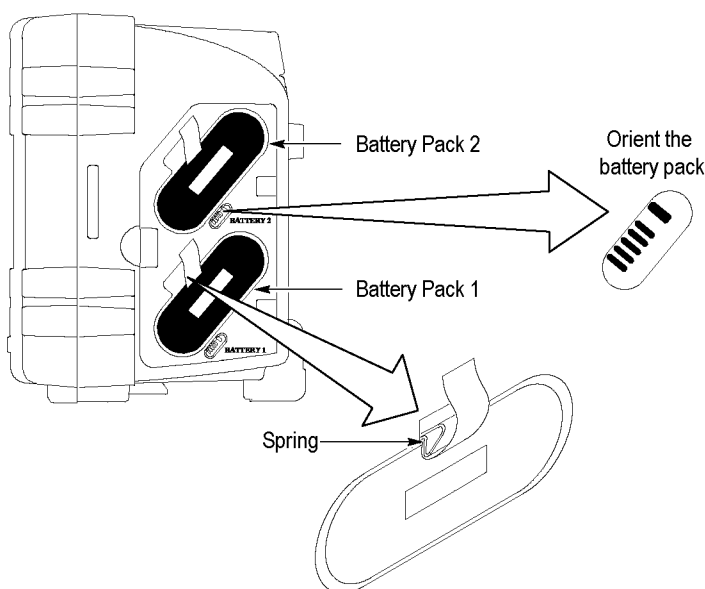

To remove the battery packs, follow these steps:

1. Press the battery compartment door latch on the right side panel and open the battery compartment.
2. Grab the strap and lift up.
3. Push the spring clip towards the outside of the battery pack and pull the strap to remove the battery pack.
4. Close the battery compartment door.

Charging Battery Packs

You can charge the battery packs in an oscilloscope or with the TPSCHG external battery charger. (See page 88, *Charging TPSBAT Battery Packs.*)

Power Cord

Use only power cords designed for the AC adapter for the oscilloscope or external charger. The AC adapter for the oscilloscope and external charger requires 90 to 264 VAC_{RMS}, 45 to 66 Hz. Optional power cords are available. (See Table 14 on page 140.)

Versatile Hanger

Use the versatile hanger to securely suspend the oscilloscope when you cannot place it on a stable surface, such as on a bench top.

To attach the hanger, follow these steps:

1. Position a hanger clip over one of the feet on the rear case so the clip is flat against the case. Orient the slot at the top of the clip.
2. Push the clip up towards the top of the case to snap it in place.

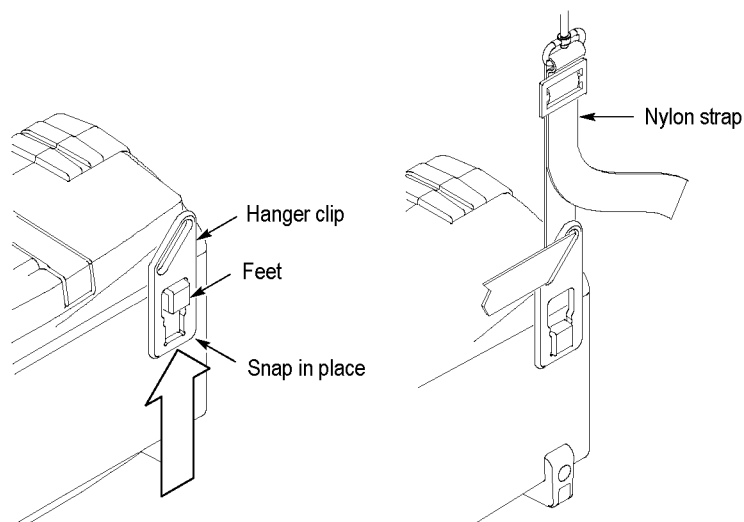

3. Repeat steps 1 and 2 for the other clip.

- 4. Adjust the length of the nylon strap. A short strap helps to keep the oscilloscope stationary while suspended.

NOTE. You can route the nylon strap through the handle on the oscilloscope to provide a more stable center of gravity.

- 5. Place the hooks over a vertical support, such as a wall partition or an instrument rack door.

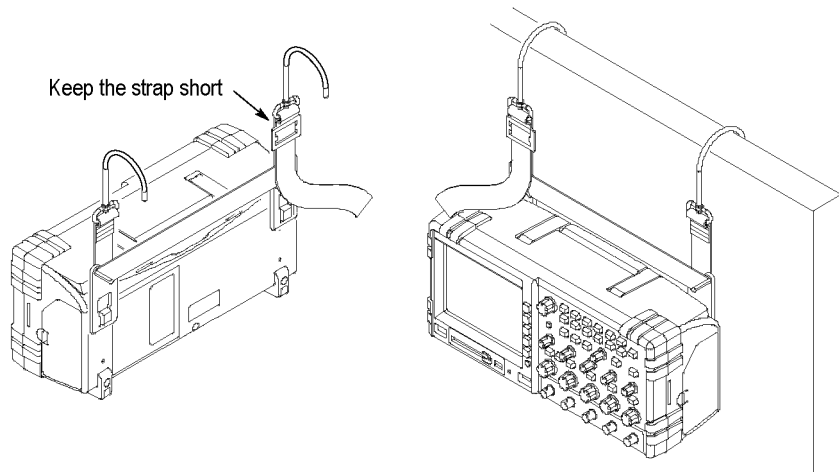

Security Lock

Use a standard laptop computer security cable to secure your oscilloscope to your location.

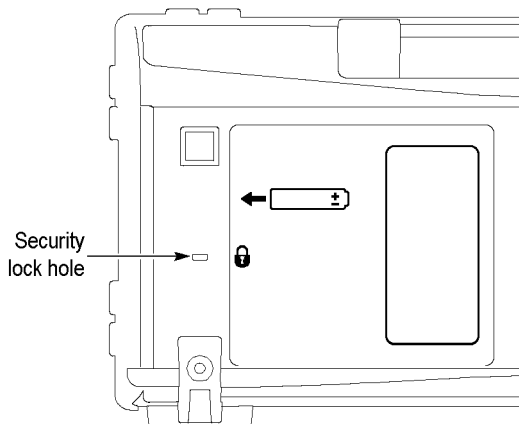

Probes

TPS2000B series oscilloscopes ship with TPP0101 or TPP0201 passive voltage probes. (See page 10, *Probe Safety*.) (See page 123, *TPS2000B Specifications*.)

You can use many Tektronix voltage probes and current probes with these oscilloscopes. Refer to Appendix C or the www.tektronix.com Web site for a list of compatible probes.

Functional Check

Perform this functional check to verify that your oscilloscope is operating correctly.

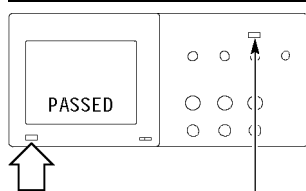

On/Standby button

Default Setup button

1. Power on the oscilloscope.
Push the **Default Setup** button.
The default Probe option attenuation setting is 10X.

Probe Comp

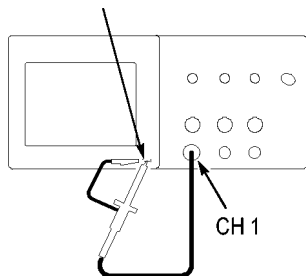

2. Connect the probe to channel 1 on the oscilloscope. To do this, align the slot in the probe connector with the key on the channel 1 BNC, push to connect, and twist to the right to lock the probe in place.
Connect the probe tip and reference lead to the Probe Comp terminals.

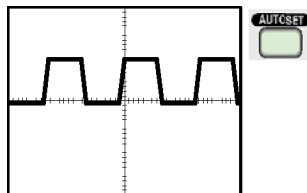

3. Push the **AutoSet** button. Within a few seconds, you should see a square wave in the display of about 5V peak-to-peak at 1 kHz.
Push the channel 1 **Menu** button on the front panel twice to remove channel 1, push the channel 2 **Menu** button to display channel 2, and repeat steps 2 and 3. For 4-channel models, repeat for channels 3 and 4.

Probe Safety

Check and observe probe ratings before using probes.

A guard around the probe body provides a finger barrier for protection from electric shock.

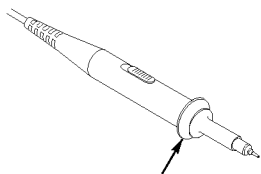

Finger guard



WARNING. To avoid electric shock when using the probe, keep fingers behind the guard on the probe body.

To avoid electric shock while using the probe, do not touch metallic portions of the probe head while it is connected to a voltage source.

Connect the probe to the oscilloscope, and connect the ground terminal to ground before you take any measurements.

Any probe or cable used to apply more than 30 V_{AC}_{RMS} (42 V peak) to the oscilloscope BNC input connector must be third-party certified for the voltage to be applied, including rating the probe reference lead or cable shield to float to 600 V_{RMS} CAT II.

This manual contains important information on isolated channels, floating measurements, and high voltages. (See page 3, *Taking Floating Measurements*.)



WARNING. Do not float the TPP0101 or TPP0201 probe reference lead to > 30 V_{RMS}. Use the P5120 probe (floatable to 600 V_{RMS} CAT II or 300 V_{RMS} CAT III) or similarly rated, passive, high voltage probe (not the ground referenced P5100 probe), or an appropriately rated, high voltage, differential probe when floating the reference lead above 30 V_{RMS}, subject to the ratings of such high voltage probe.

To avoid electric shock when using probes with exposed metal parts, do not connect the reference lead to voltages above 30 V_{RMS}.

Voltage Probe Check Wizard

You can use the Probe Check Wizard to verify that a voltage probe is operating properly. The wizard does not support current probes.

The wizard helps you adjust the compensation for voltage probes (usually with a screw on the probe body or probe connector) and set the factor for the Attenuation option for each channel, such as in the Channel 1 **Menu ▶ Probe ▶ Voltage ▶ Attenuation** option.

You should use the Probe Check Wizard each time you connect a voltage probe to an input channel.

To use the Probe Check Wizard, push the **Probe Check** button. If the voltage probe is connected properly, compensated properly, and the Attenuation option in the oscilloscope Vertical menu is set to match the probe, the oscilloscope displays a PASSED message at the bottom of the screen. Otherwise, the oscilloscope displays directions on the screen to guide you in correcting these problems.

NOTE. *The Probe Check Wizard is useful for 1X, 10X, 20X, 50X, and 100X probes. It is not useful for 500X or 1000X probes, or for probes connected to the Ext Trig BNC.*

NOTE. *When the process is complete, the Probe Check Wizard restores the oscilloscope settings (other than the Probe option) to what they were before you pushed the **Probe Check** button.*

To compensate a probe that you plan to use with the Ext Trig input, follow these steps:

1. Connect the probe to any input channel BNC, such as to channel 1.
2. Push the **Probe Check** button and follow the directions on the screen.
3. After you verify that the probe functions and is compensated properly, connect the probe to the Ext Trig BNC.

Manual Probe Compensation

As an alternative method to the Probe Check Wizard, you can manually perform this adjustment to match your probe to the input channel.

NOTE. *Be sure to properly connect the voltage probe reference lead to the Probe Comp reference terminal because the oscilloscope channels are isolated from the Probe Comp terminals.*

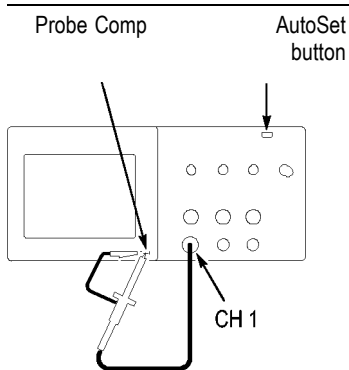

1. Push the Channel 1 **Menu ▶ Probe ▶ Voltage ▶ Attenuation** option and select **10X**. Connect the probe to channel 1 on the oscilloscope. If you use the probe hook-tip, ensure a proper connection by firmly inserting the tip onto the probe.
2. Attach the probe tip to the Probe Comp ~5V@1kHz terminal and the reference lead to the Probe Comp chassis terminal. Display the channel, and then push the **AutoSet** button.
3. Check the shape of the displayed waveform.

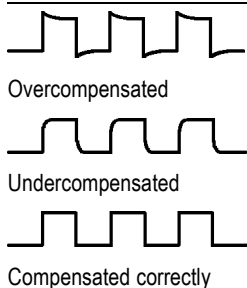

4. If necessary, adjust your probe. Repeat as necessary.

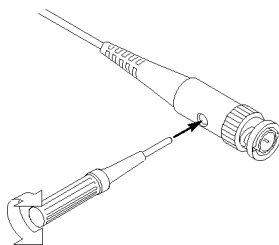

Voltage Probe Attenuation Setting

Voltage probes are available with various attenuation factors which affect the vertical scale of the signal. The Probe Check Wizard verifies that the attenuation factor in the oscilloscope matches the probe.

As an alternative method to Probe Check, you can manually select the factor that matches the attenuation of your probe. For example, to match a probe set to 10X connected to CH 1, push the Channel 1 **Menu ▶ Probe ▶ Voltage ▶ Attenuation** option, and select **10X**.

NOTE. *The default setting for the Attenuation option is 10X.*

Current Probe Scaling

Current probes provide a voltage signal proportional to the current. You need to set the oscilloscope to match the scale of your current probe. The default scale is 10 A/V.

To set the scale, follow these steps:

1. Push a vertical channel button (such as the Channel 1 **Menu** button).
2. Push the **Probe** option button.
3. Push the **Current** option button.
4. Push the **Scale** option button to select an appropriate value.

Self Calibration

The self calibration routine lets you optimize the oscilloscope signal path for maximum measurement accuracy. You can run the routine at any time but you should always run the routine if the ambient temperature changes by 5 °C (9 °F) or more. The routine takes about two minutes.

For accurate calibration, power on the oscilloscope and wait twenty minutes to ensure it is warmed up.

To compensate the signal path, disconnect any probes or cables from the input connectors. Then, access the **Utility ► Do Self Cal** option, and follow the directions on the screen.

Operating Basics

The front panel is divided into easy-to-use functional areas. This chapter provides you with a quick overview of the controls and the information displayed on the screen.

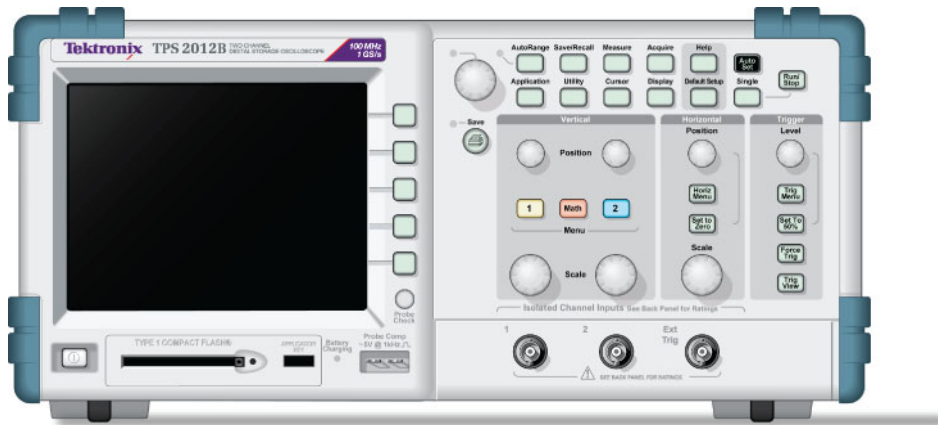

2773-003

2-channel model

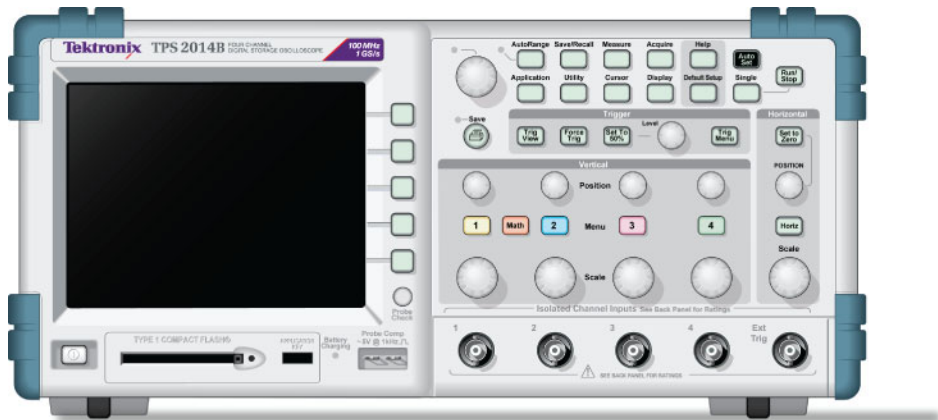

2773-002

4-channel model

The front panel buttons can be illuminated (through the Utilities menu). This illumination does not significantly affect the duration of the charge of the battery packs when you operate the oscilloscope from battery packs only.

Display Area

In addition to displaying waveforms, the display is filled with many details about the waveform and the oscilloscope control settings.

NOTE. Refer to *Displaying the FFT Spectrum* for details on displaying the FFT function, (See page 64, *Displaying the FFT Spectrum*.)

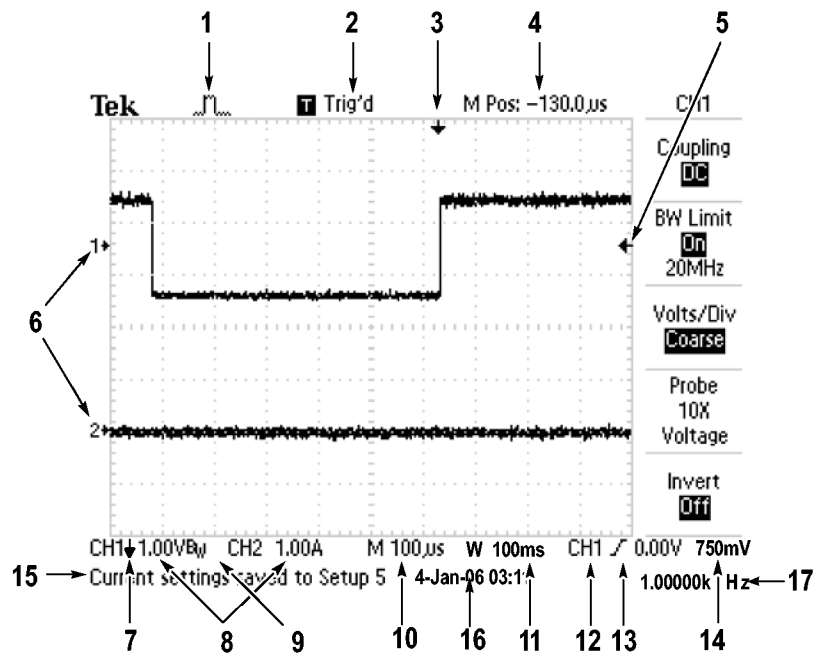

1. Icon display shows acquisition mode.



Sample mode



Peak detect mode









Average mode

2. Trigger status indicates the following:

- Armed. The oscilloscope is acquiring pretrigger data. All triggers are ignored in this state.
- Ready. All pretrigger data has been acquired and the oscilloscope is ready to accept a trigger.
- Trig'd. The oscilloscope has seen a trigger and is acquiring the posttrigger data.
- Stop. The oscilloscope has stopped acquiring waveform data.
- Acq. Complete. The oscilloscope has completed a Single Sequence acquisition.
- Auto. The oscilloscope is in auto mode and is acquiring waveforms in the absence of triggers.
- Scan. The oscilloscope is acquiring and displaying waveform data continuously in scan mode.

3. Marker shows horizontal trigger position. Turn the Horizontal Position knob to adjust the position of the marker.
4. Readout shows the time at the center graticule. The trigger time is zero.
5. Marker shows Edge or Pulse Width trigger level.
6. On-screen markers show the ground reference points of the displayed waveforms. If there is no marker, the channel is not displayed.
7. An arrow icon indicates that the waveform is inverted.
8. Readouts show the vertical scale factors of the channels.
9. A B_w icon indicates that the channel is bandwidth limited.
10. Readout shows main time base setting.
11. Readout shows window time base setting if it is in use.
12. Readout shows trigger source used for triggering.
13. Icon shows selected trigger type as follows:

	Edge trigger for the rising edge.
	Edge trigger for the falling edge.
	Video trigger for line sync.
	Video trigger for field sync.
	Pulse Width trigger, positive polarity.
	Pulse Width trigger, negative polarity.

14. Readout shows Edge or Pulse Width trigger level.

15. Display area shows helpful messages; some messages display for only three seconds.

If you recall a saved waveform, readout shows information about the reference waveform, such as RefA 1.00V 500 μ s.

16. Readout shows date and time.

17. Readout shows trigger frequency.

- Message Area** The oscilloscope displays a message area (item number 15 in the previous figure) at the bottom of the screen that conveys the following types of helpful information:
- Directions to access another menu, such as when you push the **Trig Menu** button:

For TRIGGER HOLDOFF, go to HORIZONTAL MENU
 - Suggestion of what you might want to do next, such as when you push the **Measure** button:

Push an option button to change its measurement
 - Information about the action the oscilloscope performed, such as when you push the **Default Setup** button:

Default setup recalled
 - Information about the waveform, such as when you push the **Autoset** button:

Square wave or pulse detected on CH1

Using the Menu System

The user interface of the oscilloscopes was designed for easy access to specialized functions through the menu structure.

When you push a front-panel button, the oscilloscope displays the corresponding menu on the right side of the screen. The menu shows the options that are available when you push the unlabeled option buttons directly to the right of the screen.

The oscilloscope uses several methods to display menu options:

- Page (Submenu) Selection: For some menus, you can use the top option button to choose two or three submenus. Each time you push the top button, the options change. For example, when you push the top button in the Trigger Menu, the oscilloscope cycles through the Edge, Video, and Pulse Width trigger submenus.
- Circular List: The oscilloscope sets the parameter to a different value each time you push the option button. For example, you can push one of the channel **Menu** buttons and then push the top option button to cycle through the Vertical (channel) Coupling options.

- **Action:** The oscilloscope displays the type of action that will immediately occur when you push an Action option button. For example, when the Help Index is visible, and you push the Page Down option button, the oscilloscope immediately displays the next page of index entries.
- **Radio:** The oscilloscope uses a different button for each option. The currently-selected option is highlighted. For example, the oscilloscope displays various acquisition mode options when you push the Acquire Menu button. To select an option, push the corresponding button.

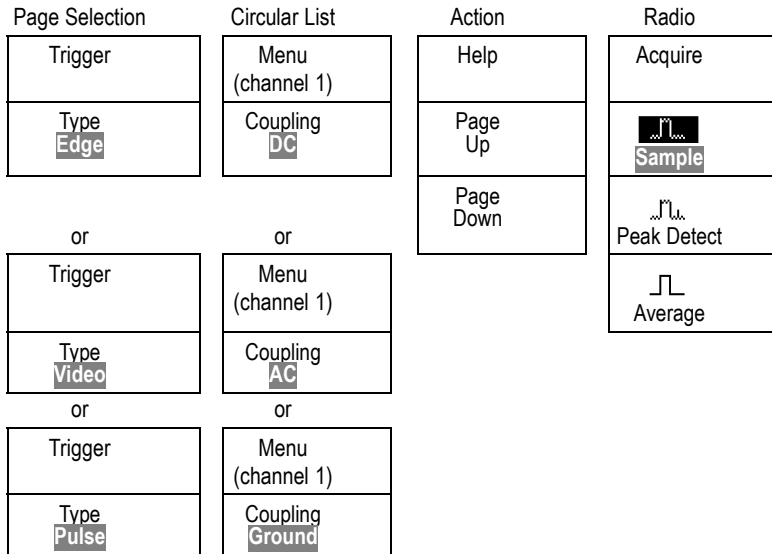

Vertical Controls

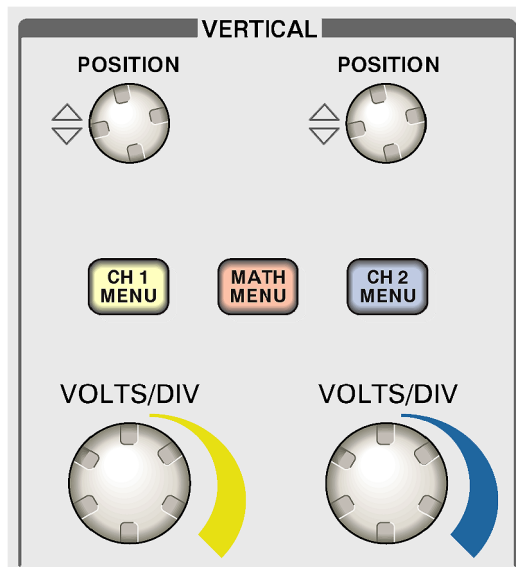

2-channel model

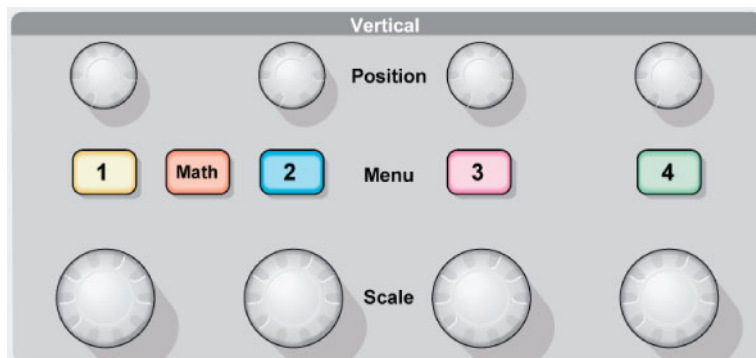

2733-004

4-channel model

Position (1, 2, 3 & 4). Positions a waveform vertically.

1, 2, 3 & 4. Displays the Vertical menu selections and toggles the display of the channel waveform on and off.

Scale (1, 2, 3 & 4). Selects vertical scale factors.

Math. Displays waveform math operations menu and toggles the display of the math waveform on and off.

Horizontal Controls



2-channel model



4-channel model

Position. Adjusts the horizontal position of all channel and math waveforms. The resolution of this control varies with the time base setting. (See page 105, *Window Zone*.)

NOTE. To make a large adjustment to the horizontal position, turn the Scale knob to a larger value, change the horizontal position, and then turn the Scale knob back to the previous value.

Horiz Menu. Displays the Horizontal Menu.

Set to Zero. Sets the horizontal position to zero.

Scale. Selects the Horizontal Scale (seconds/division) for the main or the window time base. When Window Zone is enabled, it changes the width of the window zone by changing the window time base. (See page 105, *Window Zone*.)

Trigger Controls

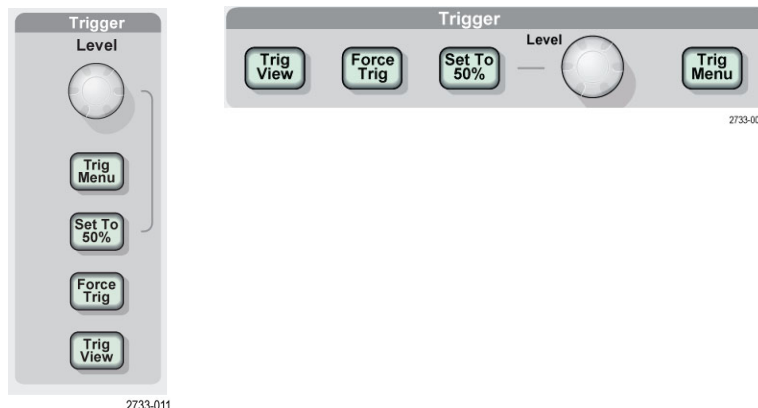

2-channel model

4-channel model

Level. When you use an Edge or Pulse trigger, the Trigger Level knob sets the amplitude level that the signal must cross to acquire a waveform.

Trig Menu. Displays the Trigger Menu.

Set to 50%. The trigger level is set to the vertical midpoint between the peaks of the trigger signal.

Force Trig. Completes an acquisition regardless of an adequate trigger signal. This button has no effect if the acquisition is already stopped.

Trig View. Displays the trigger waveform in place of the channel waveform while you hold down the **Trig View** button. Use this to see how the trigger settings affect the trigger signal, such as trigger coupling.

Menu and Control Buttons

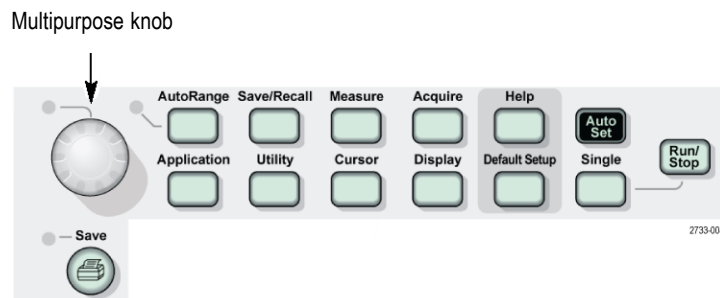

Refer to the *Reference* chapter for detailed information on the menu and button controls.

Multipurpose Knob. The function is determined by the displayed menu or selected menu option. When active, the adjacent LED lights. The next table lists the functions.

Active menu or option	Knob function	Description
Cursor	Cursor 1 or Cursor 2	Positions the selected cursor
Display	Brightness	Changes the brightness of the display
Help	Scroll	Selects entries in the Index; selects links in a topic; displays the next or previous page for a topic.
Horizontal	Set Trigger Holdoff	Sets the amount of time before another trigger event can be accepted; (See page 117, <i>Trigger Holdoff</i> .)
Math	Position	Positions the Math waveform
	Vertical Scale	Changes the scale of the Math waveform
Measure	Type	Selects the type of automatic measurement for each source.
Save/Recall	Action	Sets the transaction as save or recall for setup files, waveform files, or screen images. Use also to display or remove Ref waveforms from the display.
	File selection	Selects setup, waveform or image files to save, or selects setup or waveform files to recall.
Trigger	Video line number	Sets the oscilloscope to a specific line number when the Trigger Type option is set to Video and the Sync option is set to Line Number.
	Pulse width	Sets the width of the pulse when the Trigger Type option is set to Pulse.
Utility ► File Utilities	File selection	Selects files to rename or delete; (See page 119, <i>File Utilities</i> .)
	Name entry	Renames the file or folder; (See page 120, <i>Rename File or Folder</i> .)
Utility ► Options ► Set Date and Time	Value entry	Sets the value for the date and time; (See page 118, <i>Setting the Date and Time</i> .)

AutoRange. Displays the Autorange Menu, and activates or deactivates the autoranging function. When autoranging is active, the adjacent LED lights.

Save/Recall. Displays the Save/Recall Menu for setups and waveforms.

Measure. Displays the automated measurements menu.

Acquire. Displays the Acquire Menu.

Application. Displays a menu when an Application Key is inserted in the front of the oscilloscope, for example Power Analysis.

Utility. Displays the Utility Menu.

Cursor. Displays the Cursor Menu. Cursors remain visible (unless the Type option is set to Off) after you leave the Cursor Menu but are not adjustable.

Display. Displays the Display Menu.

Help. Displays the Help Menu.

Default Setup. Recalls the factory setup.

AutoSet. Automatically sets the oscilloscope controls to produce a usable display of the input signals.

Single. Acquires a single waveform and then stops.

Run/Stop. Continuously acquires waveforms or stops the acquisition.

Print.  Starts print operations through the Centronics or RS-232 ports, or performs the Save function to the removable mass storage.

Save. An LED indicates when the  print button is configured to save data to the CompactFlash card.

Input Connectors



2733-009

2-channel model



2733-010

4-channel model

1, 2, 3 & 4. Channel input connectors for waveform display.

Ext Trig. Input connector for an external trigger source. Use the Trigger Menu to select the Ext, or Ext/5 trigger source. Push and hold the **Trig View** button to see how the trigger settings affect the trigger signal, such as trigger coupling.

Other Front-Panel Items

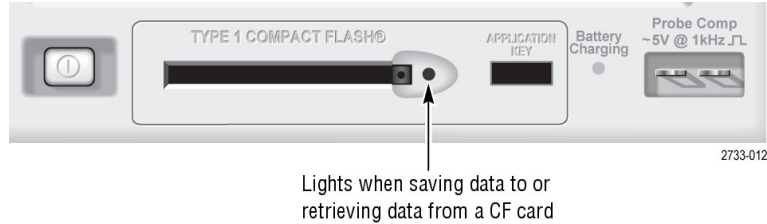

TYPE 1 CompactFlash. Insert a CompactFlash (CF) card for removable memory storage. When saving data to or retrieving data from a CF card, the adjacent LED lights. Wait until the LED goes out to remove the card.

Application Key. Insert an Application Key to enable an optional application, such as power analysis.

Battery Charging. An LED indicates when the oscilloscope is charging installed battery packs.

Probe Comp. Probe compensation output and chassis reference. Use to electrically match a voltage probe to the oscilloscope input circuit. (See page 11, *Manual Probe Compensation*.)

The probe compensation reference lead connects to earth ground and is then considered to be a ground terminal when using the oscilloscope AC adapter. (See page 3, *Taking Floating Measurements*.)



CAUTION. *When using the AC adapter, do not connect a voltage source to any exposed metal as this may damage the oscilloscope or the circuit under test.*

Understanding Oscilloscope Functions

This chapter contains general information that you need to understand before you use an oscilloscope. To use your oscilloscope effectively, you need to learn about the following functions:

- Setting up the oscilloscope
- Triggering
- Acquiring signals (waveforms)
- Scaling and positioning waveforms
- Measuring waveforms

The next figure shows a block diagram of the various functions of the oscilloscope and their relationships to each other.

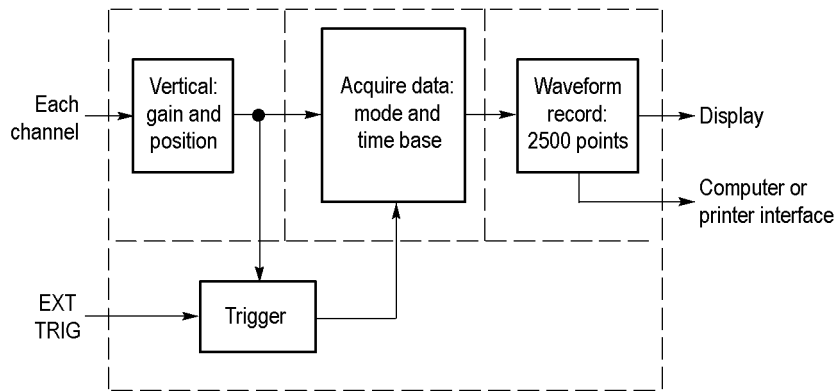

Setting Up the Oscilloscope

You should become familiar with several functions that you may use often when operating your oscilloscope: Autoset, Autorange, saving a setup, and recalling a setup.

Using Autoset

Each time you push the **AutoSet** button, the Autoset function obtains a stable waveform display for you. It automatically adjusts the vertical scale, horizontal scale and trigger settings. Autoset also displays several automatic measurements in the graticule area, depending on the signal type.

Using Autorange

Autorange is a continuous function that you can enable or disable. The function adjusts setup values to track a signal when the signal exhibits large changes or when you physically move the probe to a different point.

Saving a Setup

The oscilloscope saves the current setup if you wait five seconds after the last change before you power off the oscilloscope. The oscilloscope recalls this setup the next time you apply power.

You can use the Save/Recall Menu to save up to ten different setups.

You can also save setups to the CompactFlash card. The oscilloscope accommodates a Type 1 CompactFlash card for removable mass storage. (See page 81, *Removable Mass Storage*.)

Recalling a Setup

The oscilloscope can recall the last setup before the oscilloscope was powered off, any saved setups, or the default setup. (See page 108, *Save/Recall*.)

Default Setup

The oscilloscope is set up for normal operation when it is shipped from the factory. Push the **Default Setup** button to recall most of the factory option and control settings, but not all. Appendix E lists the default settings that will be recalled.

Triggering

The trigger determines when the oscilloscope starts to acquire data and to display a waveform. When a trigger is set up properly, the oscilloscope converts unstable displays or blank screens into meaningful waveforms.

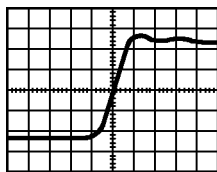

Triggered waveform

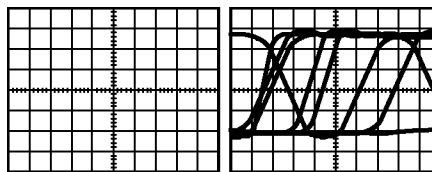

Untriggered waveforms

For oscilloscope-specific descriptions, refer to the *Operating Basics* chapter. (See page 23, *Trigger Controls*.) Refer also to the *Reference* chapter. (See page 112, *Trigger Controls*.)

When you push the **Run/Stop** or the **Single** button to start an acquisition, the oscilloscope goes through the following steps:

1. Acquires enough data to fill the portion of the waveform record to the left of the trigger point. This is called the pretrigger.
2. Continues to acquire data while waiting for the trigger condition to occur.
3. Detects the trigger condition.

4. Continues to acquire data until the waveform record is full.
5. Displays the newly-acquired waveform.

NOTE. For Edge and Pulse triggers, the oscilloscope counts the rate at which trigger events occur to determine trigger frequency. The oscilloscope displays the frequency in the lower right corner of the screen.

Source You can use the Trigger Source options to select the signal that the oscilloscope uses as a trigger. The source can be any signal connected to a channel BNC, or to the Ext Trig BNC.

Types The oscilloscope provides three types of triggers: Edge, Video, and Pulse Width.

Modes You can select the Auto or the Normal trigger mode to define how the oscilloscope acquires data when it does not detect a trigger condition. (See page 113, *Mode Options*.)

To perform a single sequence acquisition, push the **Single** button.

Coupling You can use the Trigger Coupling option to determine which part of the signal will pass to the trigger circuit. This can help you attain a stable display of the waveform.

To use trigger coupling, push the **Trig Menu** button, select an Edge or Pulse trigger, and select a Coupling option.

NOTE. Trigger coupling affects only the signal passed to the trigger system. It does not affect the bandwidth or coupling of the signal displayed on the screen.

To view the conditioned signal being passed to the trigger circuit, push and hold down the **Trig View** button.

Position The horizontal position control establishes the time between the trigger and the screen center. Refer to *Horizontal Scale and Position; Pretrigger Information* for information on how to use this control to position the trigger. (See page 31, *Horizontal Scale and Position; Pretrigger Information*.)

Slope and Level The Slope and Level controls help to define the trigger. The Slope option (Edge trigger type only) determines whether the oscilloscope finds the trigger point on the rising or the falling edge of a signal. The **Trigger Level** knob controls where on the edge the trigger point occurs.

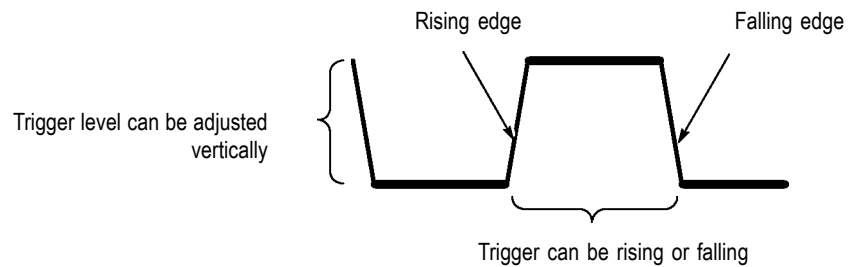

Acquiring Signals

When you acquire a signal, the oscilloscope converts it into a digital form and displays a waveform. The acquisition mode defines how the signal is digitized, and the time base setting affects the time span and level of detail in the acquisition.

Acquisition Modes

There are three acquisition modes: Sample, Peak Detect, and Average.

Sample. In this acquisition mode, the oscilloscope samples the signal in evenly spaced intervals to construct the waveform. This mode accurately represents signals most of the time.

However, this mode does not acquire rapid variations in the signal that may occur between samples. This can result in aliasing, and may cause narrow pulses to be missed. (See page 31, *Time Domain Aliasing*.) In these cases, you should use the Peak Detect Mode to acquire data.

Peak Detect. In this acquisition mode, the oscilloscope finds the highest and lowest values of the input signal over each sample interval and uses these values to display the waveform. In this way, the oscilloscope can acquire and display narrow pulses, which may have otherwise been missed in Sample mode. Noise will appear to be higher in this mode.

Average. In this acquisition mode, the oscilloscope acquires several waveforms, averages them, and displays the resulting waveform. You can use this mode to reduce random noise.

Time Base

The oscilloscope digitizes waveforms by acquiring the value of an input signal at discrete points. The time base allows you to control how often the values are digitized.

To adjust the time base to a horizontal scale that suits your purpose, use the **Scale** knob.

Scaling and Positioning Waveforms

You can change the display of waveforms by adjusting the scale and position. When you change the scale, the waveform display will increase or decrease in size. When you change the position, the waveform will move up, down, right, or left.

The channel indicator (located on the left of the graticule) identifies each waveform on the display. The indicator points to the ground reference level of the waveform record.

You can view the display area and readouts. (See page 16, *Display Area*.)

Vertical Scale and Position

You can change the vertical position of waveforms by moving them up or down in the display. To compare data, you can align a waveform above another or you can align waveforms on top of each other.

You can change the vertical scale of a waveform. The waveform display will contract or expand relative to the ground reference level.

For oscilloscope-specific descriptions, refer to the *Operating Basics* chapter. (See page 21, *Vertical Controls*.) Refer also to the *Reference* chapter. (See page 120, *Vertical Controls*.)

Horizontal Scale and Position; Pretrigger Information

You can adjust the Horizontal Position control to view waveform data before the trigger, after the trigger, or some of each. When you change the horizontal position of a waveform, you are actually changing the time between the trigger and the center of the display. (This appears to move the waveform to the right or left on the display.)

For example, if you want to find the cause of a glitch in your test circuit, you might trigger on the glitch and make the pretrigger period large enough to capture data before the glitch. You can then analyze the pretrigger data and perhaps find the cause of the glitch.

You change the horizontal scale of all the waveforms by turning the **Scale** knob. For example, you might want to see just one cycle of a waveform to measure the overshoot on its rising edge.

The oscilloscope shows the horizontal scale as time per division in the scale readout. Since all active waveforms use the same time base, the oscilloscope only displays one value for all the active channels, except when you use Window Zone. Refer to *Window Zone* for information on how to use the window function. (See page 105, *Window Zone*.)

For oscilloscope-specific descriptions, refer to the *Operating Basics* chapter. (See page 22, *Position*.) Refer also to the *Reference* chapter. (See page 104, *Horizontal*.)

Time Domain Aliasing. Aliasing occurs when the oscilloscope does not sample the signal fast enough to construct an accurate waveform record. When this happens,

the oscilloscope displays a waveform with a frequency lower than the actual input waveform, or triggers and displays an unstable waveform.

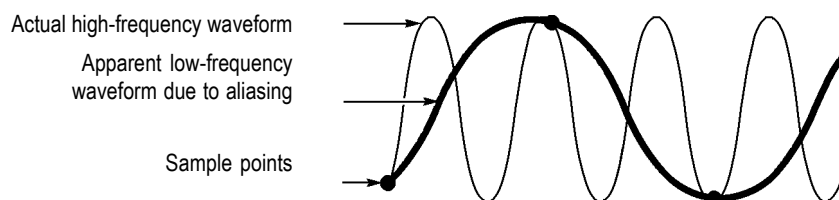

The oscilloscope accurately represents signals, but is limited by the probe bandwidth, the oscilloscope bandwidth, and the sample rate. To avoid aliasing, the oscilloscope must sample the signal more than twice as fast as the highest frequency component of the signal.

The highest frequency that the oscilloscope sampling rate can theoretically represent is the Nyquist frequency. The sample rate is called the Nyquist rate, and is twice the Nyquist frequency.

Oscilloscope models with 100 MHz bandwidths sample at rates up to 1 GS/s. Models with 200 MHz bandwidths sample at rates up to 2 GS/s. In both cases, these maximum sample rates are at least ten times the bandwidth. These high sample rates help reduce the possibility of aliasing.

There are several ways to check for aliasing:

- Turn the **Scale** knob to change the horizontal scale. If the shape of the waveform changes drastically, you may have aliasing.
- Select the Peak Detect acquisition mode. (See page 30, *Peak Detect*.) This mode samples the highest and lowest values so that the oscilloscope can detect faster signals. If the shape of the waveform changes drastically, you may have aliasing.
- If the trigger frequency is faster than the display information, you may have aliasing or a waveform that crosses the trigger level multiple times. Examining the waveform allows you to identify whether the shape of the signal is going to allow a single trigger crossing per cycle at the selected trigger level.

If multiple triggers are likely to occur, select a trigger level that will generate only a single trigger per cycle. If the trigger frequency is still faster than the display indicates, you may have aliasing.

If the trigger frequency is slower, this test is not useful.

- If the signal you are viewing is also the trigger source, use the graticule or the cursors to estimate the frequency of the displayed waveform. Compare this to the Trigger Frequency readout in the lower right corner of the screen. If they differ by a large amount, you may have aliasing.

The next table lists the time base settings that you can use to avoid aliasing at various frequencies and the respective sample rate. At the fastest Horizontal Scale setting, aliasing is not likely to occur due to the bandwidth limitations of the oscilloscope input amplifiers.

Settings to avoid aliasing in Sample mode

Time base	Samples per second	Maximum
2.5 ns	2 GS/s	200.0 MHz
5.0 to 250.0 ns	1 GS/s or 2 GS/s *	200.0 MHz
500.0 ns	500.0 MS/s	200.0 MHz
1.0 µs	250.0 MS/s	125.0 MHz
2.5 µs	100.0 MS/s	50.0 MHz
5.0 µs	50.0 MS/s	25.0 MHz
10.0 µs	25.0 MS/s	12.5 MHz
25.0 µs	10.0 MS/s	5.0 MHz
50.0 µs	5.0 MS/s	2.5 MHz
100.0 µs	2.5 MS/s	1.25 MHz
250.0 µs	1.0 MS/s	500.0 kHz
500.0 µs	500.0 kS/s	250.0 kHz
1.0 ms	250.0 kS/s	125.0 kHz
2.5 ms	100.0 kS/s	50.0 kHz
5.0 ms	50.0 kS/s	25.0 kHz
10.0 ms	25.0 kS/s	12.5 kHz
25.0 ms	10.0 kS/s	5.0 kHz
50.0 ms	5.0 kS/s	2.5 kHz
100.0 ms	2.5 kS/s	1.25 kHz
250.0 ms	1.0 kS/s	500.0 Hz
500.0 ms	500.0 S/s	250.0 Hz
1.0 s	250.0 S/s	125.0 Hz
2.5 s	100.0 S/s	50.0 Hz
5.0 s	50.0 S/s	25.0 Hz
10.0 s	25.0 S/s	12.5 Hz
25.0 s	10.0 S/s	5.0 Hz
50.0 s	5.0 S/s	2.5 Hz

* Depending on the oscilloscope model.

Taking Measurements

The oscilloscope displays graphs of voltage versus time and can help you to measure the displayed waveform.

There are several ways to take measurements. You can use the graticule, the cursors, or an automated measurement.

Graticule This method allows you to make a quick, visual estimate. For example, you might look at a waveform amplitude and determine that it is a little more than 100 mV.

You can take simple measurements by counting the major and minor graticule divisions involved and multiplying by the scale factor.

For example, if you counted five major vertical graticule divisions between the minimum and maximum values of a waveform and knew you had a scale factor of 100 mV/division, then you could calculate your peak-to-peak voltage as follows:

$$5 \text{ divisions} \times 100 \text{ mV/division} = 500 \text{ mV}$$

Cursor

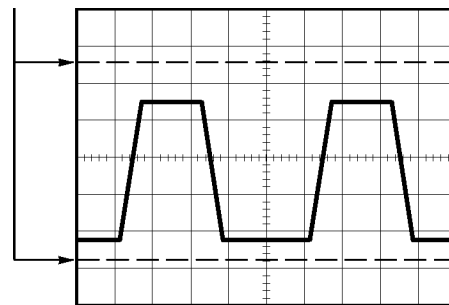

Cursors This method allows you to take measurements by moving the cursors, which always appear in pairs, and reading their numeric values from the display readouts. There are two types of cursors: Amplitude and Time.

When you use cursors, be sure to set the Source to the waveform on the display that you want to measure.

To use cursors, push the **Cursor** button.

Amplitude Cursors. Amplitude cursors appear as horizontal lines on the display and measure the vertical parameters. Amplitudes are referenced to the reference level. For the Math FFT function, these cursors measure magnitude.

Time Cursors. Time cursors appear as vertical lines on the display and measure both horizontal and vertical parameters. Times are referenced to the trigger point. For the Math FFT function, these cursors measure frequency.

Time cursors also include a readout of the waveform amplitude at the point the waveform crosses the cursor.

Automatic The Measure Menu can take up to five automatic measurements. When you take automatic measurements, the oscilloscope does all the calculating for you. Because the measurements use the waveform record points, they are more accurate than the graticule or cursor measurements.

Automatic measurements use readouts to show measurement results. These readouts are updated periodically as the oscilloscope acquires new data.

For measurement descriptions, refer to the *Reference* chapter. (See page 107, *Taking Measurements*.)

Application Examples

This section presents a series of application examples. These simplified examples highlight the features of the oscilloscope and give you ideas for using it to solve your own test problems.

- Taking simple measurements

 - Using Autoset

 - Using the Measure Menu to take automatic measurements

 - Measuring two signals and calculating gain

- Using Autorange to examine a series of test points

- Using an isolated channel to analyze a differential communication signal

- Viewing an instantaneous power waveform

- Taking cursor measurements

 - Measuring ring frequency and ring amplitude

 - Measuring pulse width

 - Measuring rise time

- Analyzing signal detail

 - Looking at a noisy signal

 - Using the average function to separate a signal from noise

- Capturing a single-shot signal

 - Optimizing the acquisition

- Measuring propagation delay

- Triggering on a pulse width

- Triggering on a video signal

 - Triggering on video fields and video lines

 - Using the window function to see waveform details

- Viewing impedance changes in a network using XY mode and persistence

Taking Simple Measurements

You need to see a signal in a circuit, but you do not know the amplitude or frequency of the signal. You want to quickly display the signal and measure the frequency, period, and peak-to-peak amplitude.

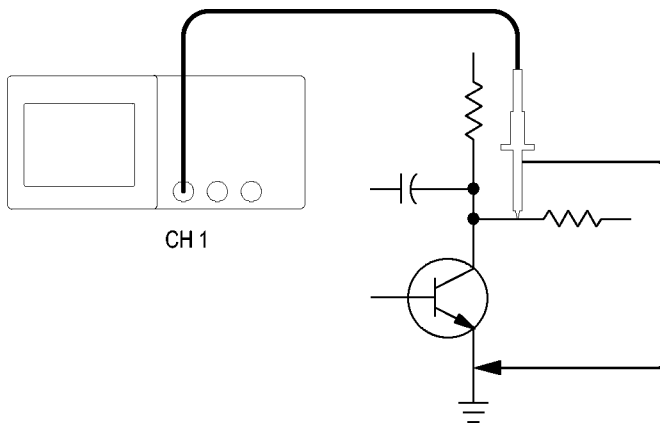

Using Autoset

To quickly display a signal, follow these steps:

1. Push the **Channel 1** button.
2. Push **Probe** ► **Voltage** ► **Attenuation** ► **10X**.
3. Connect the channel 1 probe tip to the signal. Connect the reference lead to the circuit reference point.
4. Push the **AutoSet** button.

The oscilloscope sets the vertical, horizontal, and trigger controls automatically. If you want to optimize the display of the waveform, you can manually adjust these controls.

NOTE. *The oscilloscope displays relevant automatic measurements in the waveform area of the screen based on the signal type that is detected.*

For oscilloscope-specific descriptions, refer to the *Reference* chapter. (See page 97, *Autoset*.)

Taking Automatic Measurements

The oscilloscope can take automatic measurements of most displayed signals.

NOTE. *If a question mark (?) appears in the Value readout, the signal is outside the measurement range. Adjust the Vertical Scale knob of the appropriate channel to decrease the sensitivity or change the Horizontal Scale setting.*

To measure signal frequency, period, and peak-to-peak amplitude, rise time, and positive width, follow these steps:

1. Push the **Measure** button to see the Measure Menu.

2. Push the top option button; the Measure 1 Menu appears.

3. Push **Type ► Freq.**

The **Value** readout displays the measurement and updates.

4. Push the **Back** option button.

5. Push the second option button from the top; the Measure 2 Menu appears.

6. Push **Type ► Period.**

The **Value** readout displays the measurement and updates.

7. Push the **Back** option .

8. Push the middle option ; the Measure 3 Menu appears.

9. Push **Type ► Pk-Pk.**

The **Value** readout displays the measurement and updates.

10. Push the **Back** option .

11. Push the second option from the bottom; the Measure 4 Menu appears.

12. Push **Type ► Rise Time.**

The **Value** readout displays the measurement and updates.

13. Push the **Back** option .

14. Push the bottom option ; the Measure 5 Menu appears.

15. Push **Type ► Pos Width.**

The **Value** readout displays the measurement and updates.

16. Push the **Back** option .

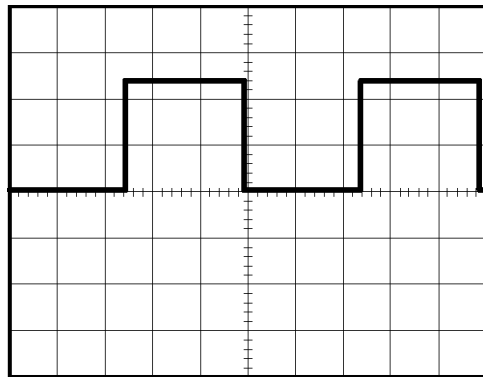

CH1
Freq
1.000kHz

CH1
Period
1.000ms

CH1
Pk-Pk
5.04V

CH1
Rise Time
2.611µs?

CH1
Pos Width
500.0µs

Measuring Two Signals

If you are testing a piece of equipment and need to measure the gain of the audio amplifier, you will need an audio generator that can inject a test signal at the amplifier input. Connect two oscilloscope channels to the amplifier input and output as shown next. Measure both signal levels and use the measurements to calculate the gain.

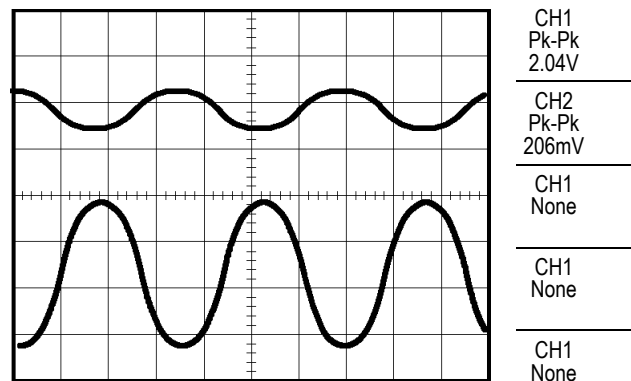
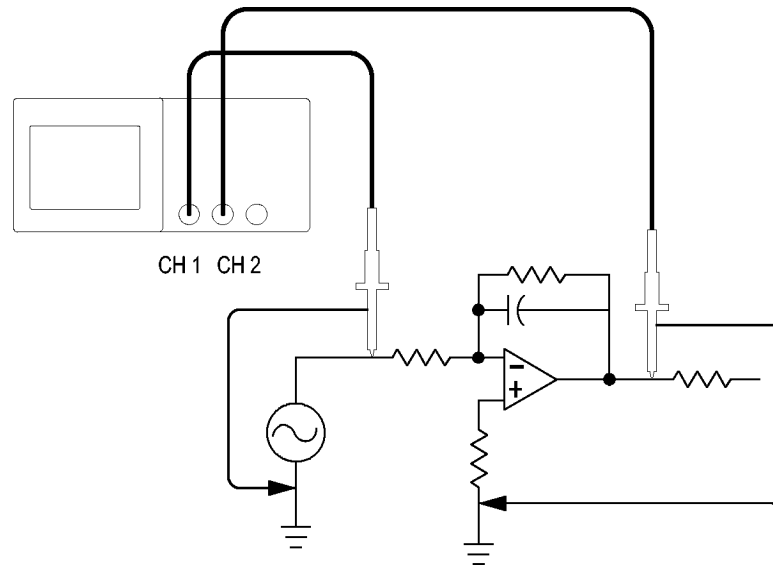

To activate and display the signals connected to channel 1 and to channel 2, and select measurements for the two channels, follow these steps:

1. Push the **AutoSet** .
2. Push the **Measure** to see the Measure Menu.
3. Push the top option ; the Measure 1 Menu appears.
4. Push **Source** ► **CH1**.
5. Push **Type** ► **Pk-Pk**.
6. Push the **Back** option .

7. Push the second option from the top; the Measure 2 Menu appears.
8. Push **Source** ► **CH2**.
9. Push **Type** ► **Pk-Pk**.
10. Push the **Back** option .

Read the displayed peak-to-peak amplitudes for both channels.

11. To calculate the amplifier voltage gain, use these equations:

$$\text{VoltageGain} = \text{output amplitude}/\text{input amplitude}$$

$$\text{VoltageGain (dB)} = 20 \times \log_{10} (\text{VoltageGain})$$

Using Autorange to Examine a Series of Test Points

If you have a machine that is malfunctioning, you may need to find the frequency and RMS voltage of several test points, and compare these values to ideal values. You are not able to access front-panel controls since you need to use both hands when probing test points that are difficult to physically reach:

1. Push the channel **1** .
2. Push **Probe ► Voltage ► Attenuation** and set to match the attenuation of the probe attached to channel 1.
3. Push the **AutoRange** to activate autoranging.
4. Push the **Measure** to see the Measure Menu.
5. Push the top option ; the Measure 1 Menu appears.
6. Push **Source ► Channel 1**.
7. Push **Type ► Freq.**
8. Push the **Back** option .
9. Push the second option from the top; the Measure 2 Menu appears.
10. Push **Source ► Channel 1**.
11. Push **Type ► Cyc RMS**.
12. Push the **Back** option .
13. Attach the probe tip and reference lead to the first test point. Read the frequency and cycle RMS measurements from the oscilloscope display and compare these to the ideal values.
14. Repeat step 13 for each test point, until you find the malfunctioning component.

NOTE. *When Autorange is active, each time you move the probe to another test point, the oscilloscope readjusts the horizontal scale, the vertical scale, and the trigger level, to give you a useful display.*

Using an Isolated Channel to Analyze a Differential Communication Signal

You are having intermittent problems with a serial data communication link, and you suspect poor signal quality. Set up the oscilloscope to show you a snapshot of the serial data stream so you can verify the signal levels and transition times.

This is a differential signal. Because the oscilloscope has isolated channels, you can view the signal with a single probe.



WARNING. Do not float the TPP0101 or TPP0201 probe reference lead to $> 30 V_{RMS}$. Use the P5120 probe (floatable to $600 V_{RMS}$ CAT II or $300 V_{RMS}$ CAT III) or similarly rated, passive, high voltage probe (not the ground referenced P5100 probe), or an appropriately rated, high voltage, differential probe when floating the reference lead above $30 V_{RMS}$, subject to the ratings of such high voltage probe.

To avoid electric shock when using probes with exposed metal parts, do not connect the reference lead to voltages above $30 V_{RMS}$.

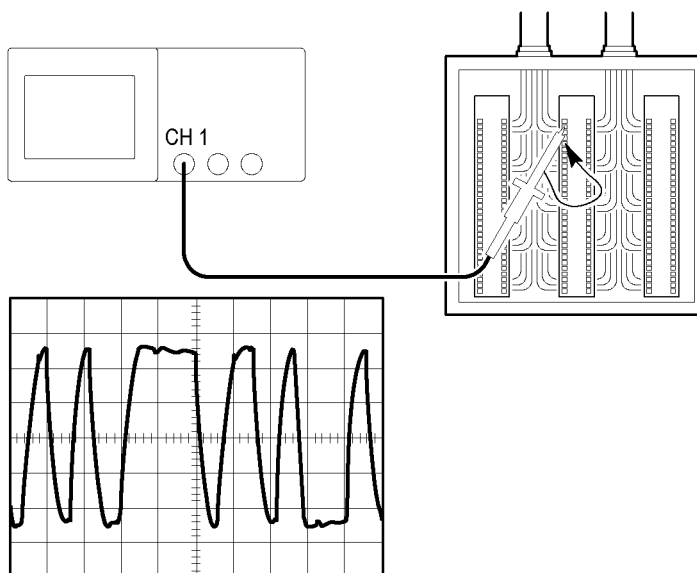

To view the differential signal, follow these steps:

1. Connect the probe tip to one side of the signal.
2. Connect the probe reference lead to the other side of the signal.
3. Push the **AutoSet** .

For a more stable display, push the **Single** to control the acquisition of the waveform. Each time you push the , the oscilloscope acquires a snapshot of the digital data stream. You can use the cursors or automatic measurements to analyze the waveform, or you can store the waveform to analyze later.

Viewing a Math Instantaneous Power Waveform

You can use a voltage probe, a current probe, and the oscilloscope math multiply function to view an instantaneous power waveform.

NOTE. Be sure to understand the rating of the voltage or current probes you are using. Do not exceed the probe rating. (See page 3, Probe Connection.)

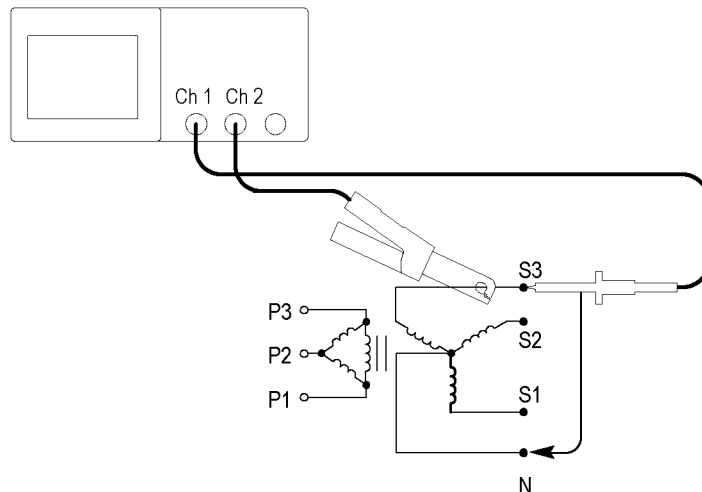

To view a math instantaneous power waveform, follow these steps:

1. Connect a voltage probe to channel 1, and a current probe to channel 2.



WARNING. Do not float the TPP0101 or TPP0201 probe reference lead to $> 30 V_{RMS}$. Use the P5120 probe (floatable to $600 V_{RMS}$ CAT II or $300 V_{RMS}$ CAT III) or similarly rated, passive, high voltage probe (not the ground referenced P5100 probe), or an appropriately rated, high voltage, differential probe when floating the reference lead above $30 V_{RMS}$, subject to the ratings of such high voltage probe.

To avoid electric shock when using probes with exposed metal parts, do not connect the reference lead to voltages above $30 V_{RMS}$.

2. Push the channel 1 .
3. Push **Probe** ► **Voltage** ► **Attenuation** and set to match the attenuation of the voltage probe.
4. Push the channel 2 .
5. Push **Probe** ► **Current** ► **Scale** and set to match the scale of the current probe.
6. Push the **AutoSet** .

7. Push **Math** ► **Operation** ► \times (multiply).
8. Push **Sources** ► **CH1** \times **CH2**.

NOTE. The vertical units of the instantaneous power waveform are VA.

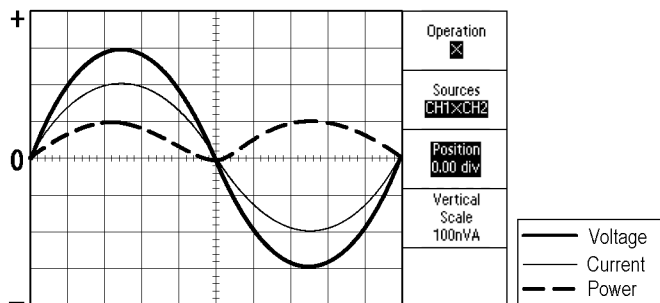

9. To obtain a better view of the Math instantaneous power waveform, you can use the following oscilloscope functions:
 - From the Math menu, push the **Position** option and turn the multipurpose knob to adjust the vertical position
 - From the Math menu, push the **Vertical Scale** option and turn the multipurpose knob to adjust the vertical scale
 - Turn the Horizontal **Scale** knob to adjust the horizontal scale
 - Push the channel **1** and **2** s to remove the channel waveforms from the display

Taking Cursor Measurements

You can use the cursors to quickly take time and amplitude measurements on a waveform.

Measuring Ring Frequency and Amplitude

To measure the ring frequency at the rising edge of a signal, follow these steps:

1. Push the **Cursor** to see the Cursor Menu.
2. Push **Type** ► **Time**.
3. Push **Source** ► **CH1**.
4. Push the **Cursor 1** option .
5. Turn the multipurpose knob to place a cursor on the first peak of the ring.
6. Push the **Cursor 2** option .
7. Turn the multipurpose knob to place a cursor on the second peak of the ring.

You can see the Δ (delta) time and frequency (the measured ring frequency) in the Cursor Menu.

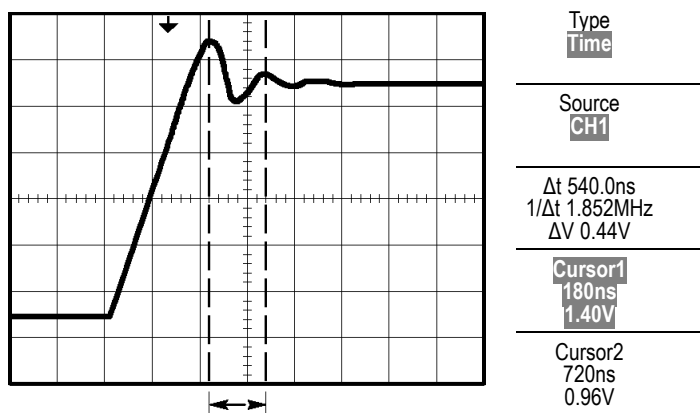

8. Push **Type** ► **Amplitude**.
9. Push the **Cursor 1** option .
10. Turn the multipurpose knob to place a cursor on the first peak of the ring.
11. Push the **Cursor 2** option .
12. Turn the multipurpose knob to place Cursor 2 on the lowest part of the ring.

You can see the amplitude of the ring in the Cursor Menu.

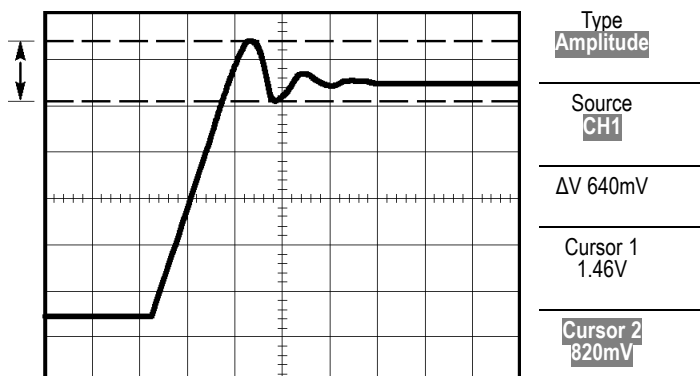

Measuring Pulse Width

If you are analyzing a pulse waveform and you want to know the width of the pulse, follow these steps:

1. Push the **Cursor** to see the Cursor Menu.
2. Push **Type** ► **Time**.
3. Push **Source** ► **CH1**.
4. Push the **Cursor 1** option .

5. Turn the multipurpose knob to place a cursor on the rising edge of the pulse.
6. Push the **Cursor 2** option .
7. Turn the multipurpose knob to place a cursor on the falling edge of the pulse.

You can see the following measurements in the Cursor Menu:

- The time at Cursor 1, relative to the trigger.
- The time at Cursor 2, relative to the trigger.
- The Δ (delta) time, which is the pulse width measurement.

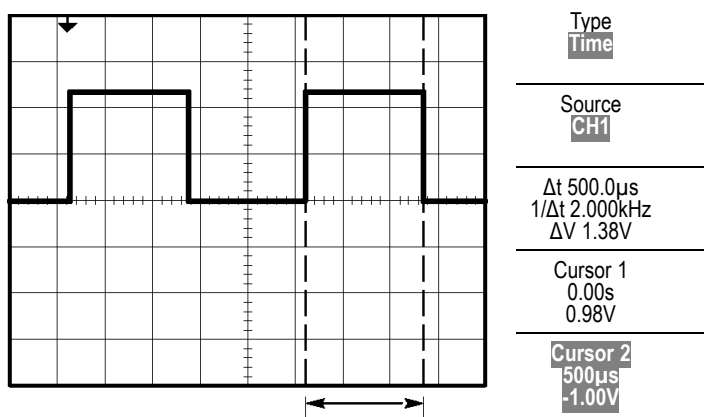

NOTE. The Positive Width measurement is available as an automatic measurement in the Measure Menu. (See page 107, Taking Measurements.)

NOTE. The Positive Width measurement also displays when you select the Single-Cycle Square option in the Autoset Menu. (See page 99, Square Wave or Pulse.)

Measuring Rise Time

After measuring the pulse width, you decide that you need to check the rise time of the pulse. Typically, you measure rise time between the 10% and 90% levels of the waveform. To measure the rise time, follow these steps:

1. Turn the Horizontal **Scale** knob to display the rising edge of the waveform.
2. Turn the Vertical **Scale** and **Position** knobs to set the waveform amplitude to about five divisions.
3. Push the channel **1** .
4. Push **Volts/Div ► Fine**.
5. Turn the Vertical **Scale** knob to set the waveform amplitude to exactly five divisions.

6. Turn the Vertical **Position** knob to center the waveform; position the baseline of the waveform 2.5 divisions below the center graticule.
7. Push the **Cursor** to see the Cursor Menu.
8. Push **Type** ► **Time**.
9. Push **Source** ► **CH1**.
10. Push the **Cursor 1** option .
11. Turn the multipurpose knob to place a cursor at the point where the waveform crosses the second graticule line below center screen. This is the 10% level of the waveform.
12. Push the **Cursor 2** option .
13. Turn the multipurpose knob to place a cursor at the point where the waveform crosses the second graticule line above center screen. This is the 90% level of the waveform.

The Δt readout in the Cursor Menu is the rise time of the waveform.

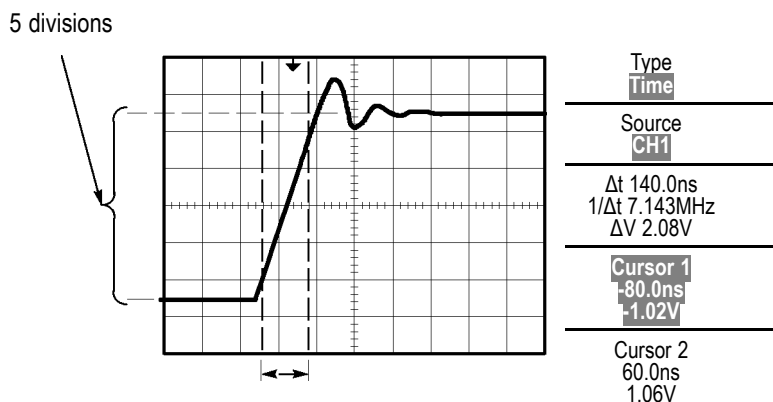

NOTE. The Rise Time measurement is available as an automatic measurement in the Measure Menu. (See page 107, Taking Measurements.)

NOTE. The Rise Time measurement also displays when you select the Rising Edge option in the Autoset Menu. (See page 99, Square Wave or Pulse.)

Analyzing Signal Detail

You have a noisy signal displayed on the oscilloscope and you need to know more about it. You suspect that the signal contains much more detail than you can now see in the display.

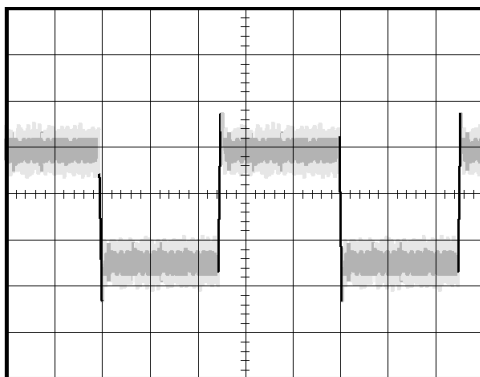

Looking at a Noisy Signal

The signal appears noisy and you suspect that noise is causing problems in your circuit. To better analyze the noise, follow these steps:

1. Push the **Acquire** to see the Acquire Menu.
2. Push the **Peak Detect** option .
3. If necessary, push the **Display** to see the Display Menu. Use the **Brightness** option with the multipurpose knob to adjust the display to see the noise more easily.

Peak detect emphasizes noise spikes and glitches in your signal, especially when the time base is set to a slow setting.

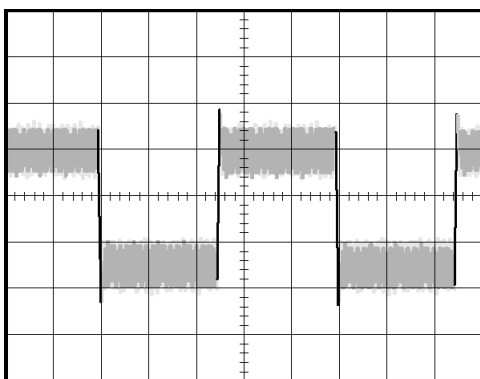

Separating the Signal from Noise

Now you want to analyze the signal shape and ignore the noise. To reduce random noise in the oscilloscope display, follow these steps:

1. Push the **Acquire** to see the Acquire Menu.
2. Push the **Average** option .
3. Push the **Averages** option to see the effects of varying the number of running averages on the waveform display.

Averaging reduces random noise and makes it easier to see detail in a signal. In the example below, a ring shows on the rising and falling edges of the signal when the noise is removed.

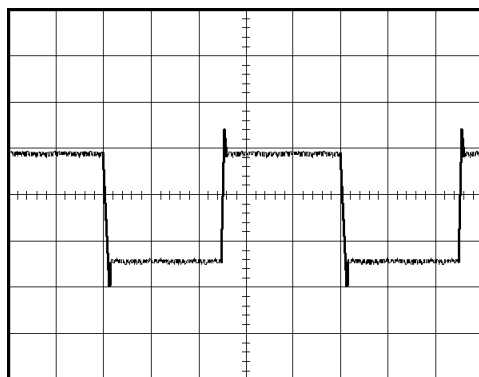

Capturing a Single-Shot Signal

The reliability of a reed relay in a piece of equipment has been poor and you need to investigate the problem. You suspect that the relay contacts arc when the relay opens. The fastest that you can open and close the relay is about once per minute, so you need to capture the voltage across the relay as a single-shot acquisition.

To set up for a single-shot acquisition, follow these steps:

1. Turn the horizontal and vertical **Scale** knobs to the appropriate ranges for the signal you expect to see.
2. Push the **Acquire** to see the Acquire Menu.
3. Push the **Peak Detect** option .
4. Push the **Trig Menu** to see the Trigger Menu.
5. Push **Slope ► Rising**.
6. Turn the **Trigger Level** knob to adjust the trigger level to a voltage midway between the open and closed voltages of the relay.
7. Push the **Single** to start the acquisition.

When the relay opens, the oscilloscope triggers and captures the event.

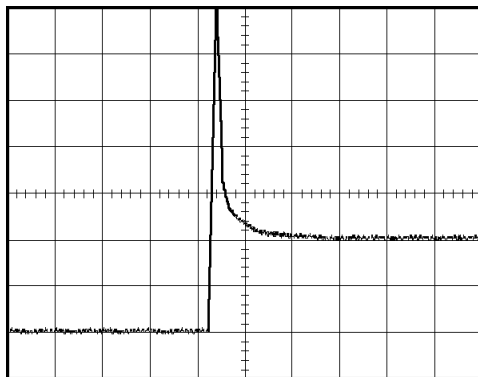

Optimizing the Acquisition

The initial acquisition shows the relay contact beginning to open at the trigger point. This is followed by a large spike that indicates contact bounce and inductance in the circuit. The inductance can cause contact arcing and premature relay failure.

You can use the vertical, horizontal, and trigger controls to optimize the settings before the next single-shot event is captured. When the next acquisition is captured with the new settings (push the **Single** again), you can see that the contact bounces several times as it opens.

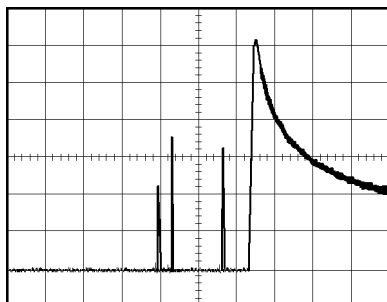

Measuring Propagation Delay

You suspect that the memory timing in a microprocessor circuit is marginal. Set up the oscilloscope to measure the propagation delay between the chip-select signal and the data output of the memory device.

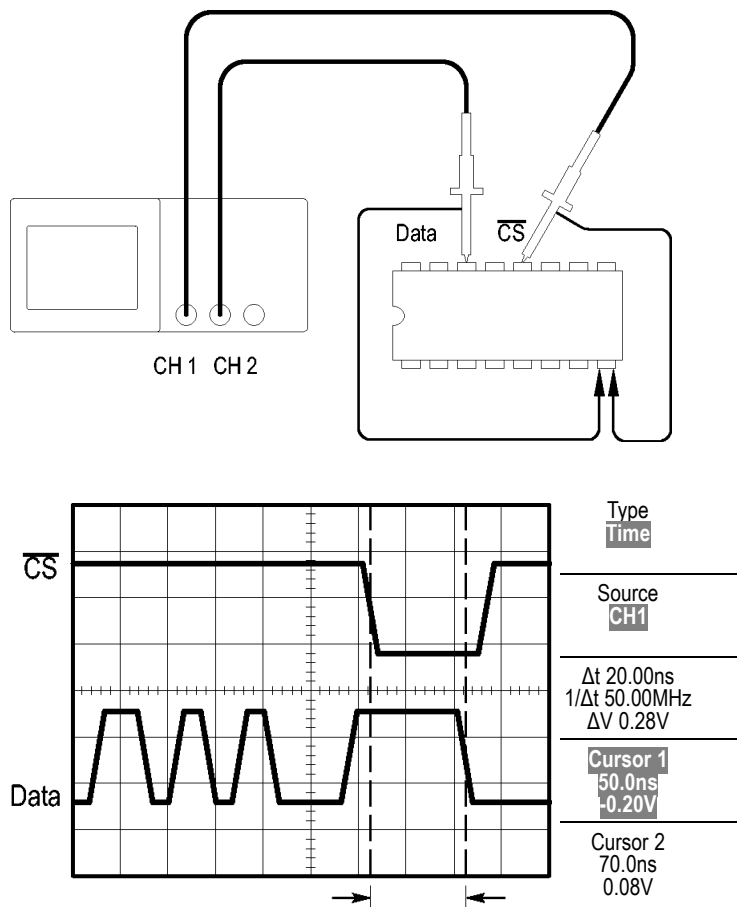

To set up to measure propagation delay, follow these steps:

1. Push the **AutoSet** to trigger a stable display.
2. Adjust the horizontal and vertical controls to optimize the display.
3. Push the **Cursor** to see the Cursor Menu.
4. Push **Type ► Time**.
5. Push **Source ► CH1**.
6. Push the **Cursor 1** option .
7. Turn the multipurpose knob to place a cursor on the active edge of the chip-select signal.

8. Push the **Cursor 2** option .
9. Turn the multipurpose knob to place the second cursor on the data output transition.

The Δt readout in the Cursor Menu is the propagation delay between the waveforms. The readout is valid because the two waveforms have the same Vertical Scale setting.

Triggering on a Specific Pulse Width

You are testing the pulse widths of a signal in a circuit. It is critical that the pulses all be a specific width, and you need to verify that they are. Edge triggering shows that your signal is as specified, and the pulse width measurement does not vary from the specification. However, you think there might be a problem.

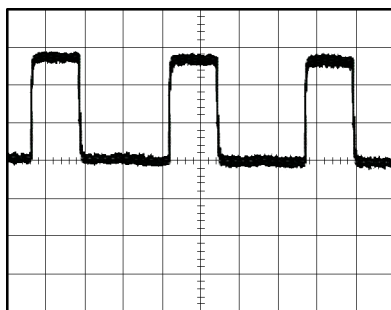

To set up a test for pulse width aberrations, follow these steps:

1. Push the **AutoSet** to trigger a stable display.
2. Push the **Single Cycle** option in the Autoset Menu to view a single cycle of the signal, and to quickly take a Pulse Width measurement.
3. Push the **Trig Menu** to see the Trigger Menu.
4. Push **Type ► Pulse**.
5. Push **Source ► CH1**.
6. Turn the **Trigger Level** knob to set the trigger level near the bottom of the signal.
7. Push **When ► = (equals)**.
8. Turn the multipurpose knob to set the pulse width to the value reported by the Pulse Width measurement in step 2.
9. Push **More ► Mode ► Normal**.

You can achieve a stable display with the oscilloscope triggering on normal pulses:

10. Push the **When** option to select \neq , $<$, or $>$. If there are any aberrant pulses that meet the specified When condition, the oscilloscope triggers.

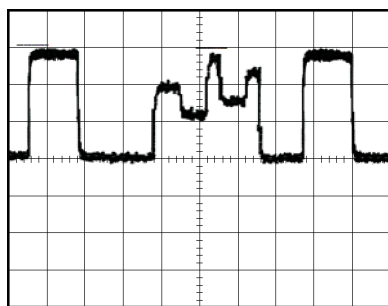

NOTE. The trigger frequency readout shows the frequency of events that the oscilloscope might consider to be a trigger, and may be less than the frequency of the input signal in Pulse Width trigger mode.

Triggering on a Video Signal

You are testing the video circuit in a piece of medical equipment and need to display the video output signal. The video output is an NTSC standard signal. Use the video trigger to obtain a stable display.

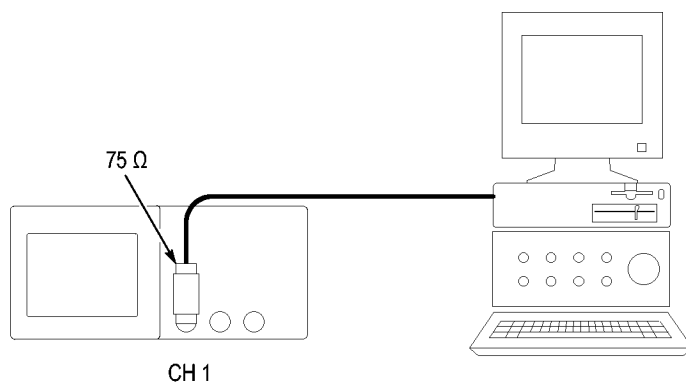

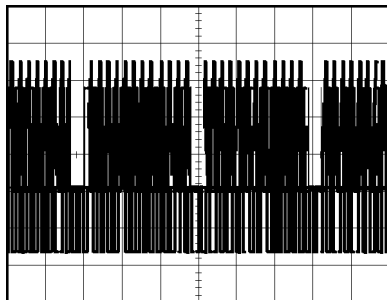

NOTE. Most video systems use 75 ohm cabling. The oscilloscope inputs do not properly terminate low impedance cabling. To avoid amplitude inaccuracy from improper loading and reflections, place a 75 ohm feedthrough terminator (Tektronix part number 011-0055-02 or equivalent) between the 75 ohm coaxial cable from the signal source and the oscilloscope BNC input.

Triggering on Video Fields

Automatic. To trigger on the video fields, follow these steps:

1. Push the **AutoSet** . When Autoset is complete, the oscilloscope displays the video signal with sync on **All Fields**.

The oscilloscope sets the Standard option when you use the Autoset function.

2. Push the **Odd Field** or **Even Field** options from the Autoset Menu to sync on odd or even fields only.

Manual. An alternative method requires more steps, but may be necessary depending on the video signal. To use the manual method, follow these steps:

1. Push the channel **1** .
2. Push **Coupling** ► **AC**.
3. Push the **Trig Menu** to see the Trigger Menu.
4. Push the top option and select **Video**.
5. Push **Source** ► **CH1**.
6. Push the **Sync** option and select **All Fields**, **Odd Field**, or **Even Field**.
7. Push **Standard** ► **NTSC**.
8. Turn the horizontal **Scale** knob to see a complete field across the screen.
9. Turn the vertical **Scale** knob to ensure that the entire video signal is visible on the screen.

Triggering on Video Lines

Automatic. You can also look at the video lines in the field. To trigger on the video lines, follow these steps:

1. Push **AutoSet**.
2. Push the top option to select **Line** to sync on all lines. (The **AutoSet** Menu includes **All Lines** and **Line Number** options.)

Manual. An alternative method requires more steps, but may be necessary depending on the video signal. To use this method, follow these steps:

1. Push the **Trig Menu** button to see the Trigger Menu.
2. Push the top option button and select **Video**.
3. Push the **Sync** option button and select **All Lines** or **Line Number** and turn the multipurpose knob to set a specific line number.
4. Push **Standard** ► **NTSC**.
5. Turn the Horizontal **Scale** knob to see a complete video line across the screen.
6. Turn the Vertical **Scale** knob to ensure that the entire video signal is visible on the screen.

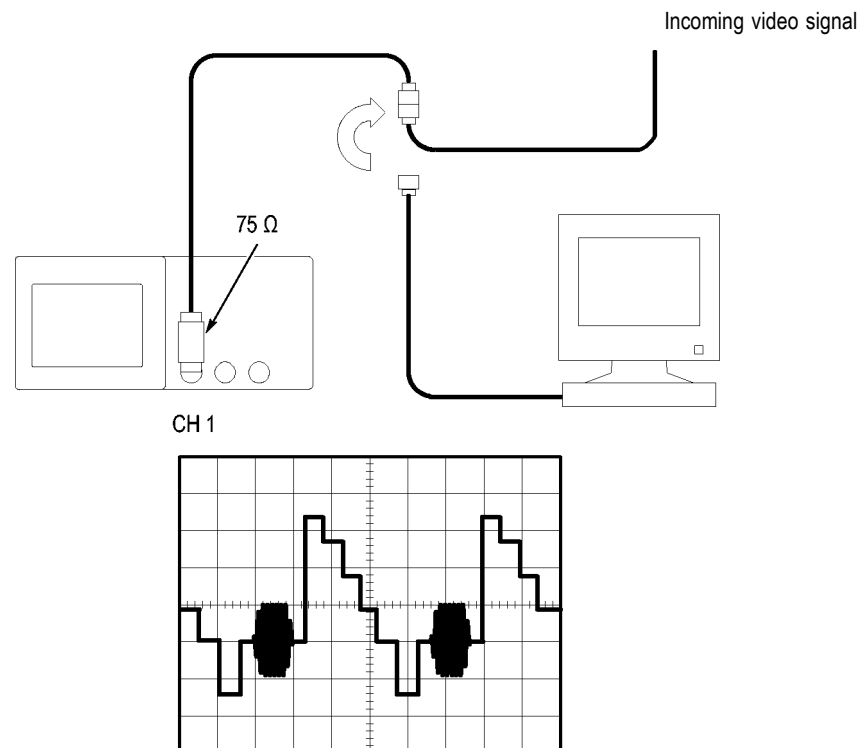

Using the Window Function to See Waveform Details

You can use the window (zoom) function to examine a specific portion of a waveform without changing the main display.

If you want to view the color burst in the previous waveform in more detail without changing the main display, follow these steps:

1. Push the Horizontal **Menu** button to see the Horizontal Menu and select the **Main** option.
2. Push the **Window Zone** option button.
3. Turn the Horizontal **Scale** knob and select 500 ns. This will be the seconds/division setting of the expanded view.
4. Turn the Horizontal **Position** knob to position the window around the portion of the waveform that you want to expand.

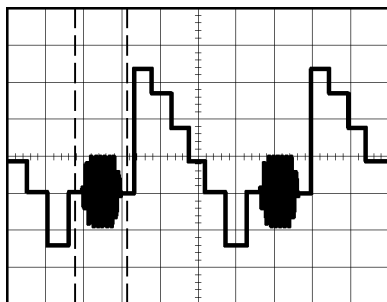

1. Push the **Window** option button to see the expanded portion of the waveform.
2. Turn the Horizontal **Scale** knob to optimize viewing the expanded waveform.

To switch between the Main and Window views, push the **Main** or **Window** option button in the Horizontal Menu.

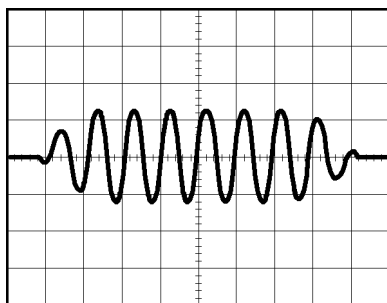

Viewing Impedance Changes in a Network

You have designed a circuit that needs to operate over a wide temperature range. You need to evaluate the change in impedance of the circuit as the ambient temperature is changed.

Connect the oscilloscope to monitor the input and output of the circuit and capture the changes that occur as you vary the temperature.

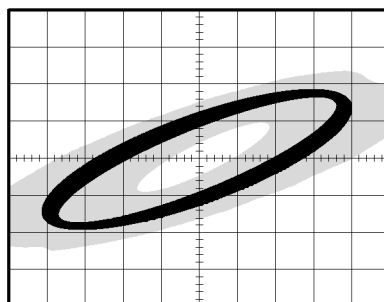
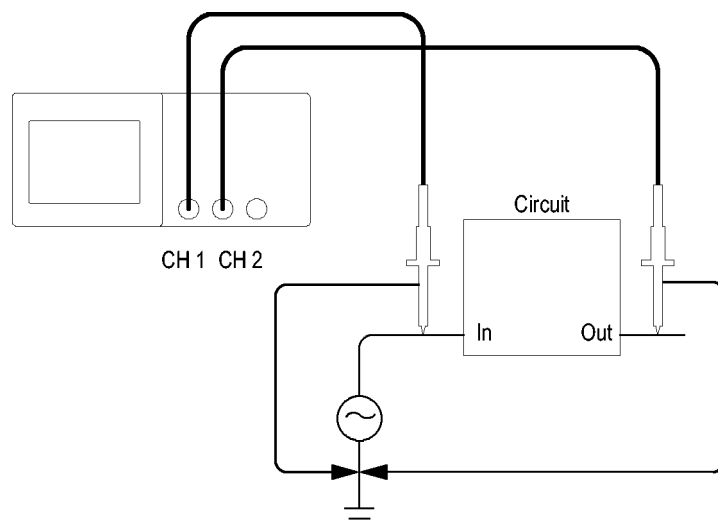

To view the input and output of the circuit in an XY display, follow these steps:

1. Push the channel 1 button.
2. Push **Probe** ► **Voltage** ► **Attenuation** ► **10X**.
3. Push the channel 2 button.
4. Push **Probe** ► **Voltage** ► **Attenuation** ► **10X**.
5. Connect the channel 1 probe to the input of the network, and connect the channel 2 probe to the output.
6. Push the **AutoSet** button.

7. Turn the Vertical **Scale** knobs to display approximately the same amplitude signals on each channel.
8. Push the **Display** button to see the Display Menu.
9. Push **Format ► XY**.

The oscilloscope displays a Lissajous pattern representing the input and output characteristics of the circuit.

10. Turn the Vertical **Scale** and **Position** knobs to optimize the display.
11. Push **Persist ► Infinite**.
12. Push the **Brightness** option button and turn the multipurpose knob to adjust the display.

As you adjust the ambient temperature, the display persistence captures the changes in the characteristics of the circuit.

Math FFT

This chapter contains detailed information on how to use the Math FFT (Fast Fourier Transform). You can use the FFT Math mode to convert a time-domain (YT) signal into its frequency components (spectrum). You can use the Math FFT mode for the following types of analysis:

- Analyze harmonics in power lines
- Measure harmonic content and distortion in systems
- Characterize noise in DC power supplies
- Test impulse response of filters and systems
- Analyze vibration

To use the Math FFT mode, you need to perform the following tasks:

- Set up the source (time-domain) waveform
- Display the FFT spectrum
- Select a type of FFT window
- Adjust the sample rate to display the fundamental frequency and harmonics without aliasing
- Use zoom controls to magnify the spectrum
- Use cursors to measure the spectrum

NOTE. For viewing the harmonics of power systems, the harmonics feature available with the optional TPS2PWR1 Power Analysis application is optimized for power measurements.

Setting Up the Time-Domain Waveform

Before you use FFT mode, you need to set up the time-domain (YT) waveform. To do so, follow these steps:

1. Push **AutoSet** to display a YT waveform.
2. Turn the Vertical **Position** knob to move the YT waveform to the center vertically (zero divisions).

This ensures that the FFT will show a true DC value.

3. Turn the Horizontal **Position** knob to position the part of the YT waveform that you want to analyze in the center eight divisions of the screen.

The oscilloscope calculates the FFT spectrum using the center 2048 points of the time-domain waveform.

4. Turn the Vertical **Scale** knob to ensure that the entire waveform remains on the screen. The oscilloscope may display erroneous FFT results (by adding high frequency components) if the entire waveform is not visible.
5. Turn the Horizontal **Scale** knob to provide the resolution you want in the FFT spectrum.
6. If possible, set the oscilloscope to display many signal cycles.

If you turn the Horizontal **Scale** knob to select a faster setting (fewer cycles), the FFT spectrum shows a larger frequency range, and reduces the possibility of FFT aliasing. (See page 66, *FFT Aliasing*.) However, the oscilloscope also displays less frequency resolution.

To set up the FFT display, follow these steps:

1. Push the **Math** button to see the Math Menu.
2. Push **Operation ► FFT**.
3. Select the **Source** channel for the Math FFT.

In many cases, the oscilloscope can produce a useful FFT spectrum even if the YT waveform is not triggered. This is especially true if your signal is periodic or random (noisy).

NOTE. *Trigger and position any transient or burst waveforms as closely as possible to the center of the screen.*

Nyquist Frequency

The highest frequency that any real-time digitizing oscilloscope can measure without errors is one-half the sample rate. This frequency is called the Nyquist frequency. Frequency information above the Nyquist frequency is undersampled, which causes FFT aliasing. (See page 66, *FFT Aliasing*.)

The math function transforms the center 2048 points of the time-domain waveform into an FFT spectrum. The resulting FFT spectrum contains 1024 points that go from DC (0 Hz) to the Nyquist frequency.

Normally, the display compresses the FFT spectrum horizontally into 250 points, but you can use the FFT Zoom function to expand the FFT spectrum to more clearly see the frequency components at each of the 1024 data points in the FFT spectrum.

NOTE. *The oscilloscope vertical response rolls off slowly above its bandwidth (100 MHz or 200 MHz, depending on the model, or 20 MHz when the Bandwidth Limit option is set to ON). Therefore, the FFT spectrum can show valid frequency information higher than the oscilloscope bandwidth. However, the magnitude information near or above the bandwidth will not be accurate.*

Displaying the FFT Spectrum

Push the **Math** button to display the Math Menu. Use the options to select the Source channel, Window algorithm, and FFT Zoom factor. You can display only one FFT spectrum at a time.

Math FFT option	Settings	Comments
Source	Channel 1, 2, 3 ¹ , 4 ¹	Selects the channel used as the FFT source
Window	Hanning, Flattop, Rectangular	Selects the FFT window type; (See page 65, <i>Selecting an FFT Window.</i>)
FFT Zoom	X1, X2, X5, X10	Changes the horizontal magnification of the FFT display; (See page 68, <i>Magnifying and Positioning an FFT Spectrum.</i>)

¹ Available only on a 4-channel oscilloscope.

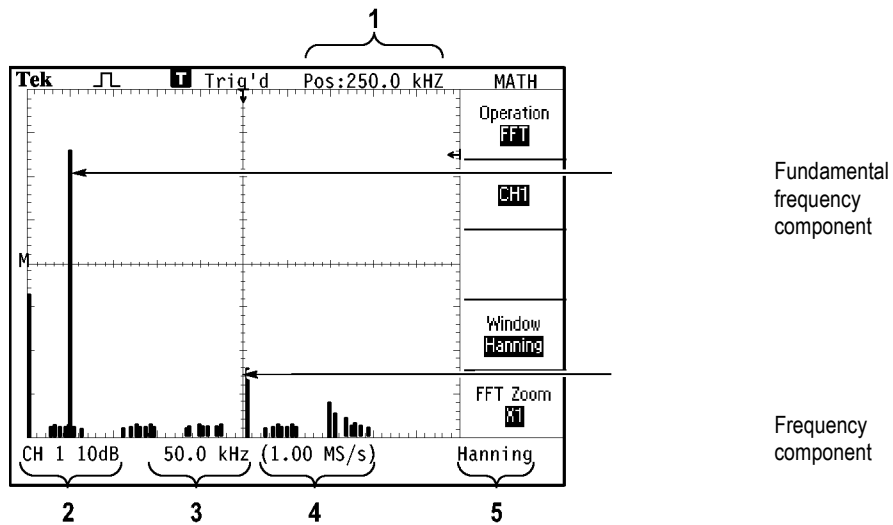

1. Frequency at the center graticule line.
2. Vertical scale in dB per division (0 dB = 1 V_{RMS}).
3. Horizontal scale in frequency per division.
4. Sample rate in number of samples per second.
5. FFT window type.

Selecting an FFT Window

Windows reduce spectral leakage in the FFT spectrum. The FFT assumes that the YT waveform repeats forever. With an integral number of cycles (1, 2, 3, ...), the YT waveform starts and ends at the same amplitude and there are no discontinuities in the signal shape.

A non-integral number of cycles in the YT waveform causes the signal start and end points to be at different amplitudes. The transitions between the start and end points cause discontinuities in the signal that introduce high-frequency transients.

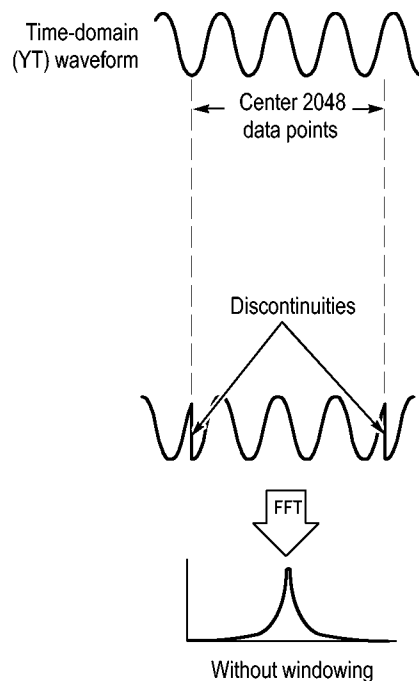

Applying a window to the YT waveform changes the waveform so that the start and stop values are close to each other, reducing the discontinuities.

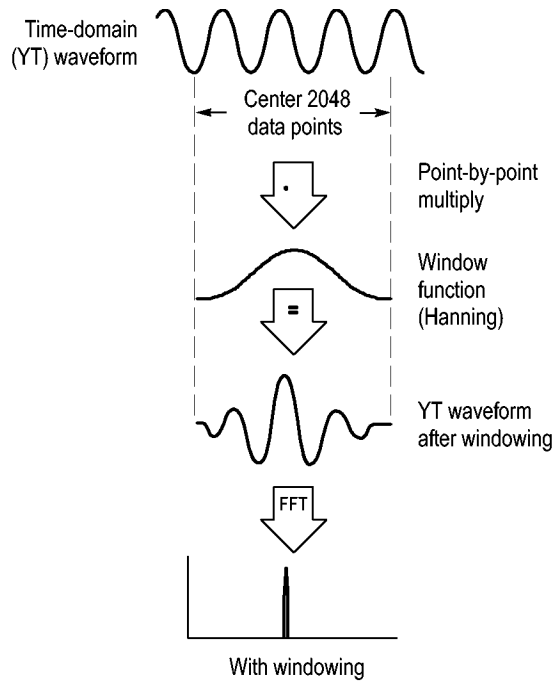

The Math FFT function includes three FFT Window options. There is a trade-off between frequency resolution and amplitude accuracy with each type of window. What you want to measure and your source signal characteristics will help you to determine which window to use.

Window	Measure	Characteristics
Hanning	Periodic waveforms	Better frequency, poorer magnitude accuracy than Flattop.
Flattop	Periodic waveforms	Better magnitude, poorer frequency accuracy than Hanning.
Rectangular	Pulses or transients	Special-purpose window for waveforms that do not have discontinuities. This is essentially the same as no window.

FFT Aliasing

Problems occur when the oscilloscope acquires a time-domain waveform containing frequency components that are greater than the Nyquist frequency. (See page 63, *Nyquist Frequency*.) The frequency components that are above the Nyquist frequency are undersampled, appearing as lower frequency components that "fold back" around the Nyquist frequency. These incorrect components are called aliases.

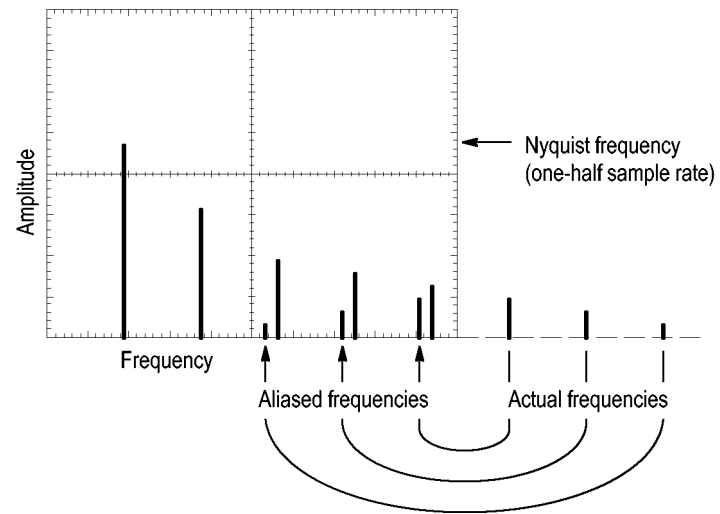

Eliminating Aliases

To eliminate aliases, try the following remedies:

- Turn the Horizontal **Scale** knob to set the sample rate to a faster setting. Since you increase the Nyquist frequency as you increase the sample rate, the aliased frequency components appear at their proper frequency. If too many frequency components are shown on the screen, you can use the FFT Zoom option to magnify the FFT spectrum.
- If you do not need to view frequency components above 20 MHz, set the Bandwidth Limit option to On.
- Put an external filter on the source signal to bandwidth limit the source waveform to frequencies below that of the Nyquist frequency.
- Recognize and ignore the aliased frequencies.
- Use zoom controls and the cursors to magnify and measure the FFT spectrum.

Magnifying and Positioning an FFT Spectrum

You can magnify and use cursors to take measurements on the FFT spectrum. The oscilloscope includes an FFT Zoom option to magnify horizontally. To magnify vertically, you can use the vertical controls.

Horizontal Zoom and Position

The FFT Zoom option lets you horizontally magnify the FFT spectrum without changing the sample rate. Zoom factors are X1 (default), X2, X5, and X10. At zoom factor X1, and with the waveform centered in the graticule, the left graticule line is at 0 Hz and the right graticule line is at the Nyquist frequency.

When you change the zoom factor, the FFT spectrum is magnified about the center graticule line. In other words, the axis of horizontal magnification is the center graticule line.

Turn the Horizontal **Position** knob clockwise to move the FFT spectrum to the right. Push the **Set to Zero** button to position the center of the spectrum at the center of the graticule.

Vertical Zoom and Position

The channel vertical knobs become vertical zoom and position controls for their respective channels when displaying the FFT spectrum. The Vertical Scale knob provides zoom factors of X0.5, X1 (default), X2, X5, and X10. The FFT spectrum is vertically magnified about the M marker (math waveform reference point on the left edge of the screen).

Turn the Vertical **Position** knob clockwise to move the spectrum up for the source channel.

Measuring an FFT Spectrum Using Cursors

You can take two measurements on FFT spectrums: magnitude (in dB), and frequency (in Hz). Magnitude is referenced to 0 dB, where 0 dB equals $1 V_{RMS}$.

You can use the cursors to take measurements at any zoom factor. To do so, follow these steps:

1. Push the **Cursor** button to see the Cursor Menu.
2. Push **Source** ► **Math**.
3. Push the **Type** option button to select **Magnitude** or **Freq**.
4. Use the multipurpose knob to move cursors 1 and 2.

Use horizontal cursors to measure magnitude and vertical cursors to measure frequency. The options display the delta between the two cursors, the value at cursor 1 position, and the value at cursor 2 position. Delta is the absolute value of cursor 1 minus cursor 2.

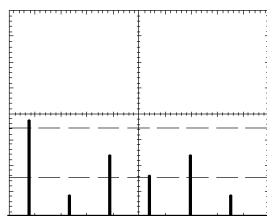

Magnitude cursors

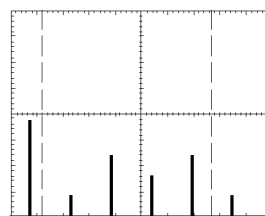

Frequency cursors

You can also take a frequency measurement without using the cursors. To do so, turn the Horizontal Position knob to position a frequency component on the center graticule line and read the frequency at the top right of the display.

Communications (RS-232, Centronics, and RS-232/USB)

Use the communications functions of the oscilloscope to do the following tasks:

- Send a screen image to an external device (printer or computer)
- Set up and test the RS-232 interface
- Set up and use the RS-232/USB cable



WARNING. Do not float the TPP0101 or TPP0201 probe reference lead to $> 30 V_{RMS}$. Use the P5120 probe (floatable to $600 V_{RMS}$ CAT II or $300 V_{RMS}$ CAT III) or similarly rated, passive, high voltage probe (not the ground referenced P5100 probe), or an appropriately rated, high voltage, differential probe when floating the reference lead above $30 V_{RMS}$, subject to the ratings of such high voltage probe.

To avoid electric shock when using probes with exposed metal parts, do not connect the reference lead to voltages above $30 V_{RMS}$.

The oscilloscope power-up banner displays a warning message similar to that shown above. The first RS232 command that the oscilloscope receives will clear this warning message.

Sending a Screen Image to an External Device

The oscilloscope lets you send a screen image to an external device, such as a printer or computer.

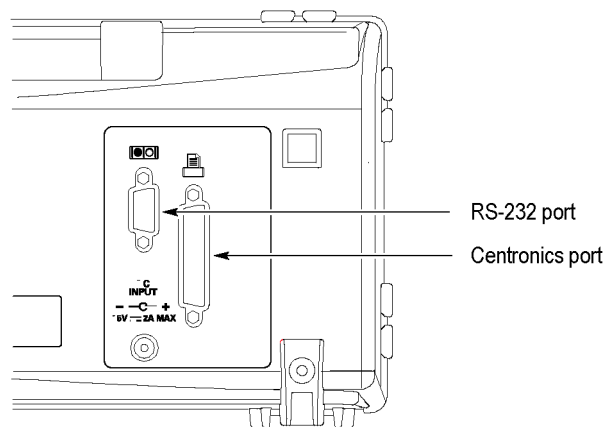

Printer Setup To set up a printer, follow these steps:

1. Power on the oscilloscope.
2. Push **Utility ► Options ► Printer Setup**.
3. Push the option buttons to change the settings to match those of your printer. The next table lists the settings you can change.

Option	Settings	Comments
Print Button	Prints	You can set the  print button to perform other functions. (See page 83, <i>Using the Save function of the Print Button.</i>)
Printer Port	Centronics, RS-232	Communications port used to connect the oscilloscope to a printer or computer.
Printer Format ¹	DPU411, DPU412, DPU3445, Thinkjet, Deskjet, Laser Jet, Bubble Jet, Epson Dot, Epson C60, Epson C80, BMP, PCX, TIFF, RLE, EPSIMAGE	Type of device connected to the communications port or file format.
Layout	Portrait, Landscape	Printer output orientation.
Ink Saver	On, Off	Prints the screen image on a white background.
Abort Printing		Stops sending the screen image to the printer.

¹ Refer to the www.tektronix.com/printer_setup Web page for a list of compatible printers.

The next table lists the file formats.

File format	Extension	Comments
BMP	BMP	The default; this bitmap format uses a lossless compression algorithm, and is compatible with most word processing and spreadsheet programs.
PCX	PCX	DOS Paintbrush format.
TIFF	TIF	Tagged Image File Format.
RLE	RLE	Run-length encoding; this format uses a lossless compression algorithm.
EPSIMAGE	EPS	Postscript format.

NOTE. The oscilloscope stores these settings until you change them, even if you push the **Default Setup** button.

If you use the RS-232 port, you also need to set up the parameters for the port appropriately for your printer.

Testing the Printer Port

To test the printer port, follow these steps:

1. If you have already connected the oscilloscope to a printer, go to step 4.
2. Power off the oscilloscope and the printer.
3. Connect the oscilloscope to the printer using the appropriate cable.
4. Power on the oscilloscope and the printer.
5. If you have not done so already, define an appropriate printer setup. (See page 72, *Printer Setup*.)
6. Push the  print button. The printer begins printing a copy of the oscilloscope screen within twenty seconds, depending on the selected printer.

Printing an Oscilloscope Screen Image

To print a screen image, push the  print button. The oscilloscope takes a few seconds to capture the screen image. The settings of your printer and print speed determine how long it takes to print the data. Additional time may be required according to the format selected.

NOTE. *You can use the oscilloscope while the printer prints.*

Setting Up and Testing the RS-232 Interface

You may need to set up and test the RS-232 interface. RS-232 is an 8-bit serial communications standard that lets the oscilloscope communicate with an external RS-232 device such as a computer, terminal, or printer. The standard defines two device types: Data Terminal Equipment (DTE) and Data Communications Equipment (DCE). The oscilloscope is a DTE device.

The *RS-232 Connector Pinout Diagram* shows the pin numbers and signal assignments of the 9-pin RS-232 connector. (See page 77, *RS-232 Connector Pinout Diagram*.)

Selecting an RS-232 Cable

You need an RS-232 cable to connect the oscilloscope to an external device. Use the next table to choose the correct cable.

To connect the oscilloscope to	Use this type cable	Tektronix part number
PCs with 9-pin serial port connector	9-pin female to 9-pin female, null modem	012-1379-00
PCs with 25-pin serial port connector	9-pin female to 25-pin female, null modem	012-1380-00

To connect the oscilloscope to	Use this type cable	Tektronix part number
Sun workstations, and serial printers, such as an HP Deskjet	9-pin female to 25-pin male, null modem	012-1298-00
Telephone modems	9-pin female to 25-pin male, modem	012-1241-00

Connecting an External Device

When you connect the oscilloscope to an external RS-232 device, follow these guidelines:

- Use the correct cable (refer to the preceding table).
- Use a cable that is no longer than 50 feet (15 meters).
- Power off the oscilloscope and the external device before you connect the cable between them.

NOTE. *This manual contains information on connecting external devices when making floating measurements. (See page 3, Taking Floating Measurements.)*

RS-232 Settings

To set up the oscilloscope RS-232 interface, follow these steps:

1. Push the **Utility** button to see the Utility Menu.
2. Push **Options ► RS232 Setup**.
3. Push the option buttons to match the settings of your external device. The next table lists the settings you can change.

NOTE. *The oscilloscope stores these settings until you change them, even if you push the **Default Setup** button.*

Option	Settings	Comments
Set to Defaults		Sets the RS-232 interface to factory defaults (Baud=9600, Flow=hardflagging, EOL String=LF, Parity=None).
Baud	300, 600, 1200, 2400, 4800, 9600, 19200	Sets the data transmission rate.
Flow Control	Hardflagging, Softflagging, None	Sets data flow control (Softflagging = Xon/Xoff, Hardflagging = RTS/CTS). Use hardware flagging when you transfer binary data.

Option	Settings	Comments
EOL String	CR, LF, CR/LF, LF/CR	Sets the end-of-line terminator sent by the oscilloscope; the oscilloscope can receive any EOL string.
Parity	None, Even, Odd	Adds an error check bit (ninth bit) to each character.

NOTE. *When you set the Parity option to None, the oscilloscope uses 8 data bits and 1 stop bit. When you set the Parity option to Even or to Odd, the oscilloscope uses 7 data bits and 1 stop bit.*

You can use the OpenChoice Desktop software included with the oscilloscope to begin transferring information from the oscilloscope to your PC. If the software does not work, then try testing the RS-232 interface.

To test the oscilloscope RS-232 interface, follow these steps:

1. Connect the oscilloscope to a personal computer (PC) using an appropriate RS-232 cable. (See page 73, *Selecting an RS-232 Cable*.)
2. Power on the PC.
3. On the PC, run a terminal emulator program, such as Microsoft Windows Hyperterminal. Make sure the PC serial port is set as follows:

Function	Setting
Baud rate	9600
Data flow control	Hardflagging
Parity	None

You also need to set up the terminal emulator program to see characters sent. Enabling echo and CRLF will keep lines from overlapping.

4. Power on the oscilloscope.
5. Push the **Utility** button to see the Utility Menu.
6. Push **Options ► RS232 Setup**.
7. Check that the menu settings match those listed in the preceding table.
8. From your PC terminal program, type ID?, then press the Return or Enter key to send the command. The oscilloscope sends back its identification string, which should look similar to the following:

ID TEK/TPS 2024B, CF:91.1CT, FV:V10.00

NOTE. *This manual contains brief information about command entry. (See page 78, Command Entry.)*

For complete command information, refer to the TDS200, TDS1000/2000, TDS1000B/2000B, TDS2000C, and TPS2000/TPS2000B Series Digital Oscilloscopes Programmer Manual.

RS-232 Troubleshooting

If the oscilloscope and the external device (computer or printer) have trouble communicating, follow these steps:

1. Check that you are using the correct RS-232 cable. Determine whether your external device requires a null-modem or a straight-through connection. (See page 73, *Selecting an RS-232 Cable*.)
2. Check that the RS-232 cable is firmly connected to both the oscilloscope and the correct port on the external device.
3. Check that the printer or the program on the personal computer is using the same port to which you connected the RS-232 cable. Try your program or printer again.
4. Check that the oscilloscope RS-232 settings match the settings used by the external device:
 - a. Determine the RS-232 settings for the external device.
 - b. Push the **Utility** button to see the Utility Menu.
 - c. Push ► **Options** ► **RS232 Setup**.
 - d. Set the oscilloscope to match the settings of the external device.
 - e. Try the free Open Choice Desktop software again.
 - f. Try your terminal-emulator program or printer again.
5. Try setting both the oscilloscope and the external device to a slower baud rate.
6. If you receive only part of the printer file, try these remedies:
 - a. Lengthen the timeout for the external device.
 - b. Make sure the printer is set to receive a binary file, not a text file.

Transferring Binary Data

To use the RS-232 port to transfer binary data to the oscilloscope, set up the interface as follows:

- Use hardware flagging (RTS/CTS) whenever possible. Hardware flagging guarantees no data loss.
- All eight bits of binary data contain meaningful information. To make sure that all eight bits are received or transmitted, configure the external RS-232 device to receive and transmit eight-bit characters (set the RS-232 word length to eight bits).

Reporting RS-232 I/O Errors

Errors are reported when there is a problem with parity, framing, or input/output buffer overruns. To report errors, the oscilloscope posts an event code. When an error occurs, the oscilloscope discards all input and output and waits for a new command.

Checking Command Status

If you want to check the status of each command sent, append an *STB? query after every command and read the response string.

Processing Break Signals

When the oscilloscope senses a break signal on the RS-232 port, it returns the three character string DCL followed by the end-of-line terminator. Internally, the oscilloscope acts as if it received a GPIB <DCL> command (device clear), causing the oscilloscope to erase the contents of the input and output buffers and then wait for a new command. Break signals do not change oscilloscope settings or stored data and do not interrupt front-panel operation or nonprogrammable functions.

If a break signal is sent in the middle of a character stream, several characters immediately preceding or following the break can be lost. The controller waits until it receives the three character string DCL and the end of line terminator string before sending more characters.

RS-232 Connector Pinout Diagram

The next figure shows the pin numbering and signal assignments for the RS-232 connector.

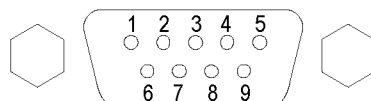

- | | | |
|---|---------------------------|----------|
| 1 | No connection | |
| 2 | Receive data (RxD) | (input) |
| 3 | Transmit data (TxD) | (output) |
| 4 | Data terminal ready (DTR) | (output) |
| 5 | Signal ground (GND) | |
| 6 | Data set ready (DSR) | (input) |
| 7 | Request to send (RTS) | (output) |
| 8 | Clear to send (CTS) | (input) |
| 9 | No connection | |

Command Entry

When you enter oscilloscope commands over the RS-232 bus, follow these general rules:

- You can enter commands in upper or lower case.
- You can abbreviate many oscilloscope commands. These abbreviations are shown in uppercase letters. For example, the command ACQUIRE:NUMAVg can be entered simply as ACQ:NUMAV or acq:numav.
- You can precede any command with white space characters. White space characters include any combination of the ASCII control characters 00 through 09 and 0B through 20 hexadecimal (0 through 9 and 11 through 32 decimal).
- The oscilloscope ignores commands that consist of just a combination of white space characters and line feeds.

Refer to the *TDS200*, *TDS1000/2000*, *TDS1000B/2000B*, *TDS2000C*, and *TPS2000/2000B Series Digital Oscilloscopes Programmer Manual* (077-0444-XX) for more information.

Setting Up and Using the RS-232/USB Cable

Use the standard accessory RS-232/USB cable (Tektronix part number 174-5813-00) to connect the TPS2000B oscilloscope to a USB port on the PC.

Install Drivers

1. Insert the USB end of the RS-232/USB cable into a USB port on the PC. The PC will run the Found New Hardware Wizard.

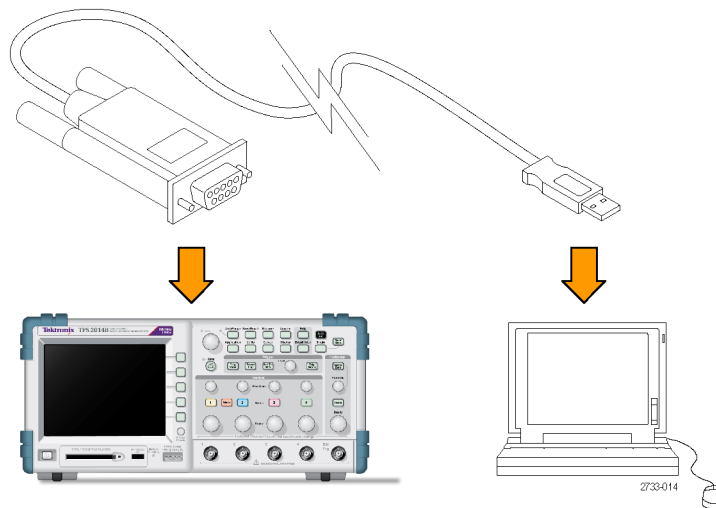

NOTE. If the Found New Hardware Wizard does not run, the drivers are probably already installed on your PC.

2. Install the USB Serial Converter driver files:
 - If you have Internet access, select **Yes, this time only** and click **Next**. Follow the on-screen instructions to install the software automatically.
 - If you do not have Internet access, select **No, not this time** and click **Next**. Follow the on-screen instructions to install from a specific location, such as from the Tektronix OpenChoice, PC Communications Software CD (063-3675-XX) that came with your instrument.
3. The Found New Hardware Wizard will install the USB Serial Port drivers, if they are required. Repeat step 2, as needed, to install these drivers.

The PC should now have completed its RS-232/USB cable driver install. You may need to reboot the PC before you can use the RS-232/USB cable.

OpenChoice Desktop

One way to utilize the RS-232/USB cable-based oscilloscope-to-PC connection is with the Tektronix OpenChoice Desktop program. This free application lets you capture oscilloscope screen images, waveform data and settings from a Microsoft Windows computer.

You can load the OpenChoice Desktop program from the Tektronix OpenChoice Desktop PC Communications Software CD that came with your oscilloscope. You can also download a copy from www.tektronix.com/software. You can find it there by searching on “OpenChoice”.

Removable Mass Storage

The oscilloscope accommodates a Type 1 CompactFlash (CF) card for removable mass storage. The oscilloscope can save data to and retrieve data from the CF card.

Installing and Removing a CompactFlash (CF) Card

The front of the oscilloscope has a Type 1 CF card slot.

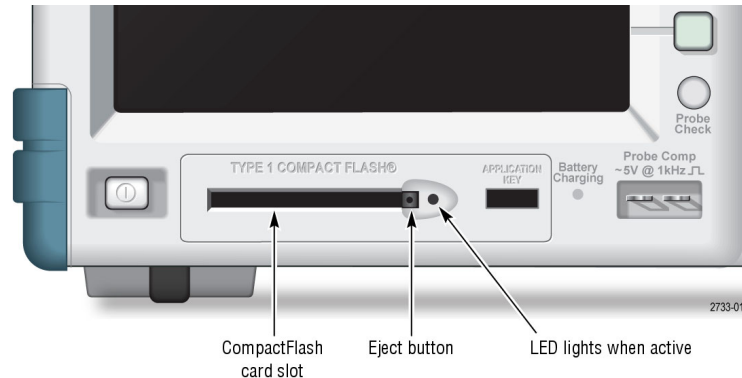

To install a CF card, follow these steps:

1. Align the card with the card slot on the oscilloscope. Type1 cards are keyed.
2. Insert the card into the slot until the card is flush with the front panel. If the card does not easily slide into place, remove it and reinsert it correctly.

To remove a CF card, follow these steps:

1. Push and release the eject button until the button fully extends.
2. Push the eject button again to release the card from the slot.
3. Pull the CF card out of the front-panel slot.

CF Card Initial Read Time

The oscilloscope reads the internal structure of a CF card each time you insert a card. The time to complete the read depends on the size of the CF card and how it is formatted.

To significantly shorten the initial read time of 64 MB and larger CF cards, format the CF card in the oscilloscope.

Formatting a CF Card

The Format function deletes all data on the CF card. To format a CF card, follow these steps:

1. Insert a CF card into the CF card slot.
2. Push the **Utility** button to see the Utility Menu.

3. Push **File Utilities** ► **More** ► **Format**.
4. Select **Yes** to format the CF card.

CF Card Capacities

The oscilloscope can store the following types and number of files per 1 MB of CF card memory:

- 5 Save All operations. (See page 108, *Save All*.)
- 16 screen image files (capacity depends on the image format). (See page 109, *Save Image*.)
- 250 oscilloscope setting (.SET) files. (See page 109, *Save Setup*.)
- 18 waveform (.CSV) files. (See page 110, *Save Waveform*.)

File Management Conventions

The oscilloscope uses the following file management conventions for mass storage:

- It checks for available space on the CF card before writing files, and displays a warning message if there is not enough memory available
- The term folder refers to a directory location on the CF card
- The default location for the file save or file recall functions is the current folder
- The root folder is A:\
- The oscilloscope resets the current folder to A:\ when you power on the oscilloscope, or when you insert a CF card after the oscilloscope is powered on
- File names can have one to eight characters, followed by a period, and then followed with an extension of one to three characters
- It displays long file names created on PC operating systems with the shortened file name from the operating system
- File names are upper case

You can use the File Utilities menu to do the following tasks:

- List the contents of the current folder
- Select a file or folder
- Navigate to other folders
- Create, rename, and delete files and folders
- Format the CF card

This manual contains more details on the **Utility** ► File Utilities menu. (See page 119, *File Utilities*.)

Using the Save function of the Print Button

You can change the function of the  print button through one of the following options:

- **Save/Recall ► Save All ► Print Button**
- **Utility ► Options ► Printer Setup**

Print Button option	Comments
Saves All to Files	Sets the button to save all active oscilloscope information (waveforms, screen image, settings) to files in a new subfolder in the current CF card folder.
Saves Image to File	Sets the button to save the screen image to a file on the CF card.
Prints	(See page 72, <i>Printer Setup</i> .)

NOTE. An LED by the  print button lights to indicate the alternative Save function that writes data to the CF card.

Saves All to Files

This option allows you to save all of the current oscilloscope information to files on the CF card. Before you can save data to the CF card, you need to configure the **Print** button to the alternative Save function. To do so, select **Save/Recall ► Save All ► Print Button ► Saves All to Files**.

When you push the **Save** button, the oscilloscope creates a new folder on the CF card and saves the information in separate files in that new folder, using the current oscilloscope and file format settings. The oscilloscope names the folder ALLnnnn.

Source	File name
CH(x)	FnnnnCHx.CSV, where nnnn is an automatically-generated number, and x is the channel number.
MATH	FnnnnMTH.CSV.
Ref(x)	FnnnnRFx.CSV, where x is the reference memory letter.
Screen Image	FnnnnTEK.???, where ??? is the current Saves Image to File format.
Settings	FnnnnTEK.SET.

File type	Contents and uses
.CSV	Contains ASCII text strings that list the time (relative to the trigger) and amplitude values for each of the 2500 waveform data points; you can import .CSV files into many spreadsheet and math analysis applications.
Screen images	Import files into spreadsheet and word processing applications; type of image file depends on the application.
.SET	Contains an ASCII text string listing of the oscilloscope settings; refer to the <i>TDS200</i> , <i>TDS1000/2000</i> , <i>TDS1000B/2000B</i> , <i>TDS2000C</i> , and <i>TPS2000/TPS2000B Series Digital Oscilloscopes Programmer Manual</i> to decode strings.

Saves Image to File

This option allows you to save the oscilloscope screen image to a file named TEKnnnn.???, where ??? is the specified graphics file format. (See page 109, *Save Image*.)

Before you can save data to the CF card, you need to configure the  print button to the alternative Save function. To do so, select **Save/Recall ► Save All ► Print Button ► Saves Image to File**.

Managing TPSBAT Battery Packs

The TPSBAT Lithium-Ion rechargeable battery packs require routine maintenance and care in their use and handling. Be sure to follow the guidelines in this section to safely use TPSBAT Lithium-Ion batteries and achieve the maximum battery life span.

This section contains information on the following topics:

- Maintaining battery packs
- Charging battery packs
- Handling battery packs
- Storing and transporting battery packs
- Replacing the original battery packs

TPSBAT Battery Pack Considerations

Do not leave a battery unused for an extended period of time, either in the product or in storage. When a battery has been unused for six months, check the charge status and charge or dispose of the battery as appropriate.

The typical estimated life of a Lithium-Ion battery is about two to three years, or 300 charge cycles, whichever occurs first. One charge cycle is a period of use from fully charged, to fully discharged, and fully recharged again. You should use a two to three year life expectancy for batteries that do not run through complete charge cycles.

A rechargeable Lithium-Ion battery has a limited life and will gradually lose its capacity to hold a charge. This loss of capacity (aging) is irreversible. As the battery loses capacity, the length of time it will power the product (run time) decreases.

A Lithium-Ion battery continues to slowly discharge (self-discharge) when not in use or while in storage. You need to routinely check the charge status of the battery.

When you troubleshoot battery issues for dual-battery configurations, only one battery pack should be installed. You need to test one battery pack and one battery slot at a time.

Use only TPSBAT battery packs in your TPS2000B series oscilloscope.

Maintaining Battery Packs

- Observe and note the run time that a new fully-charged battery provides for powering your product. You can use this new battery run time as a basis to compare run times for older batteries. The run time of your battery will vary depending on the product's configuration and the applications that you run.
- Routinely check the charge status of the battery.
- Carefully monitor batteries that are approaching the end of their estimated life.
- Consider replacing the battery with a new one if the battery run time drops below about 80% of the original run time, or the battery charge time increases significantly.
- Follow the storage requirements if you store or do not use a battery for an extended period. If you do not follow the storage requirements, and the battery has no charge remaining when you check it, you can consider the battery to be damaged. Do not attempt to recharge it or to use it. Replace it with a new battery.

General Charging Guidelines

Continuous Charging You do not need to continuously charge (trickle charge) Li-Ion battery packs to maintain full operating capacity between jobs. However, a Lithium-ion battery pack will self-discharge during non-use. To achieve the longest operating time, charge your battery pack before use. If you plan to store battery packs, read the specific instructions to do this. (See page 91, *Storage*.)

Charging Temperature Charge the battery packs within an ambient temperature range of 0 °C to +40 °C (+32 °F to +104 °F). Charging battery packs outside of this range can damage cells or cause them to leak. Charging efficiency is best between 0 °C and +30 °C (+32 °F and +86 °F) with less than 80% relative humidity.

Discharging Temperature The battery packs are rated to discharge between -10 °C and +50 °C (-14 °F and +122 °F) with less than 80% relative humidity. Discharging outside of this range can cause damage. Battery discharge capacity drops significantly at temperatures below 0 °C (+32 °F) and above +40 °C (+104 °F).

Cold temperatures adversely affect the normal electrochemical reactions within a battery pack, reducing the available capacity. Although Li-Ion battery packs can discharge down to -10 °C (-14 °F) without damage, the available capacity is significantly reduced below 0 °C (+32 °F). You can minimize this loss by keeping the battery packs above 0 °C (+32 °F) prior to and during use.

Checking the Charge and Calibration Status

The **Utility ► System Status ► Misc** option shows the amount of time you can continue to operate the oscilloscope from the battery packs and the battery charge status. If the oscilloscope is operating from the AC adapter, only the battery charge status is reported.

The remaining time calculation is based on a one minute running average of the current drain for the battery pack in use. Wait at least one minute after you power on the oscilloscope to ensure an accurate reading.

Calibration refers to the ability of a battery pack to report its current capacity, which the oscilloscope uses to calculate how much longer it can operate under the current conditions.

A battery pack loses its calibration after repeated cycles of discharging and charging in which the battery pack is not allowed to fully discharge. For example, if you operate a battery pack for one hour a day or less, and recharge it after each use, over time the battery pack will become uncalibrated.

An uncalibrated battery pack cannot accurately report its remaining operating time. (See page 90, *Calibrating Battery Packs*.)

Charging TPSBAT Battery Packs

You can charge the battery packs in an oscilloscope or in the external battery charger.

Charge method	Amount of time to charge per battery
Oscilloscope (internal with the AC adapter)	With the oscilloscope power ON, 7 hours
	With the oscilloscope power on STANDBY, 4.5 hours
External (TPSCHG)	3 hours



WARNING. Do not attempt to charge a battery pack below 0 °C (+32 °F) or above +40 °C (+104 °F). Charging a battery pack outside of this range can damage the battery pack and will result in a partial charge.

Internal Charge

The oscilloscope has a built-in charge system that can charge internal battery packs while the AC adapter is connected. A fully discharged battery pack requires approximately 4.5 hours to fully charge if the oscilloscope is powered down. If the oscilloscope is operating, a battery pack can take up to 7 hours to fully charge.

If the oscilloscope has two battery packs installed, it will charge the battery pack with the highest available capacity first, until fully charged. It will then charge the second battery pack.

Likewise, if the oscilloscope has two battery packs installed, it will operate from the battery pack with the lowest available capacity until it reaches full discharge. The oscilloscope will then operate from the second battery pack until it reaches full discharge.

To charge a battery pack in the oscilloscope, follow these steps:

1. Place the battery pack in the battery compartment. (See page 6, *Battery Packs*.)
2. Apply external power from the oscilloscope AC adapter. The green, Battery Charging indicator on the front panel lights and the battery pack begins to charge immediately.

External Charge

You can use the optional TPSCHG battery charger to externally charge battery packs. Appendix C includes information on optional accessories. (See Table 14 on page 140.)

To use the external charger, follow these steps:

1. Place up to two battery packs in the charger slots. Battery packs are keyed, so you can insert them only one way.
2. The battery packs begin to charge immediately.

LEDs indicate which battery pack is being charged, the status of the charge, and when the charge is complete.

LED color	Status
None	No battery is in the charger
Green flashing	Fast charge is in progress
Green solid	Fully charged
Yellow flashing	Recalibration is in process
Yellow flashing and Green solid	Recalibration complete
Yellow solid	Standby mode
Red flashing	Error

If the Red LED flashes, follow these steps:

1. Check that the charger is not overheating. Ensure that the charger fan is running and that the airflow is not blocked. If the charger continues to overheat, replace the TPSCHG.
2. If the charger is not overheating, the TPSBAT battery pack is defective. You should replace the battery pack and dispose of the defective battery. The Environmental Considerations section contains information on Disposal and Recycling. (See page xi, *Environmental Considerations*.)

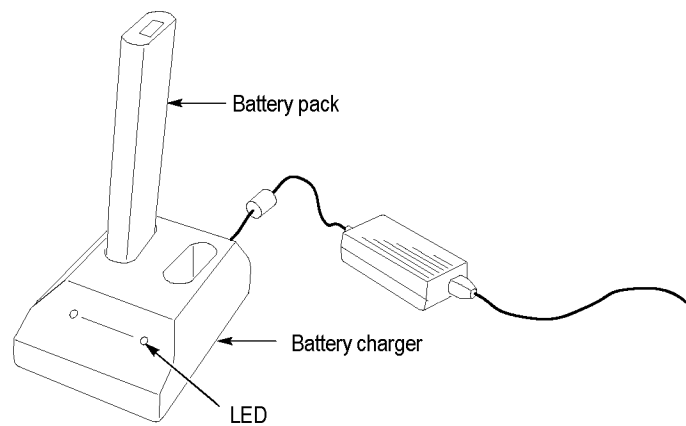

Calibrating Battery Packs

An uncalibrated battery pack cannot accurately report its remaining operating time. The basic idea of calibration is to cycle the battery pack from a fully charged state to a fully discharged state, and then back to a fully charged state. This is what the external charger does as part of the routine, and what the internal charge method does step-by-step.

External Calibration

You can use the optional TPSCHG battery charger to calibrate battery packs. Appendix C includes information on optional accessories. (See Table 14 on page 140.) For complete information, refer to the manual for the battery charger.

To calibrate battery packs, follow these steps:

1. Place the battery pack in the left-hand slot of the charger.
2. Push the blue and red symbol between the **Push to Recalibrate Battery in Left Bay** label and the **Energy Access Incorporated** label.
3. After at least 3 minutes, check the LED status of the charger for errors.

The charger will charge, discharge, and then fully recharge the battery pack returning it to a fully calibrated state. The calibration process can take up to ten hours to complete. Overnight calibration is recommended due to the slow nature of the discharge-charge cycle.

Internal Calibration

If you do not have a TPSCHG battery charger, you can still calibrate a battery pack inside the oscilloscope. To do so, follow these steps:

1. Power down the oscilloscope to allow a faster charge rate.
2. Apply external power from the oscilloscope AC adapter for approximately 5 hours per battery pack.
3. Remove the oscilloscope AC adapter.
4. Push the front panel power switch to power on the oscilloscope.
5. Operate the oscilloscope until it powers off, indicating the battery pack is fully discharged (approximately 5.5 hours for 2-channel models and 4.5 hours for 4-channel models for each battery pack).
6. Again, apply external power from the oscilloscope AC adapter for approximately 5 hours for each battery pack. During this time, do not power on the oscilloscope.

If the battery pack is not fully charged and calibrated, attempt to calibrate the battery pack again. If the second attempt fails, replace the battery pack.

Handling Battery Packs

- Do not disassemble, crush, or puncture a battery.
- Do not short the external contacts on a battery.
- Do not dispose of a battery in fire or water.
- Do not expose a battery to temperatures above +60 °C (+140 °F)
- Keep the battery away from children.
- Avoid exposing the battery to excessive shock or vibration.
- Do not use a damaged battery.
- If a battery pack has leaking fluids, do not touch any fluids. Dispose of a leaking battery pack. The Environmental Considerations section contains information on Disposal and Recycling. (See page xi, *Environmental Considerations*.)
- In case of eye contact with fluid, do not rub eyes. Immediately flush eyes thoroughly with water for at least 15 minutes, lifting upper and lower lids, until no evidence of the fluid remains. Seek medical attention.

Storing and Transporting Battery Packs

- Storage**
- Store battery packs in a low-humidity environment (less than 80% relative humidity) free of corrosive gases. Storing battery packs in high-humidity environments, or outside the temperature range, can cause oxidation on the metallic parts and increased leakage.
 - Charge or discharge the battery to approximately 50% of capacity before storage.
 - Charge the battery to approximately 50% of capacity at least once every six months.
 - Remove the battery and store it separately from the oscilloscope.
 - Store the battery at temperatures between +5 °C and +20 °C (+41 °F and +68 °F).

NOTE. *The battery self-discharges during storage. Higher temperatures (above +20 °C or +68 °F) reduce the battery storage life.*

Transportation Information The Environmental Considerations section contains information on Transporting Batteries. (See page xi, *Transporting Batteries*.)

Replacing Battery Packs

Use the instructions to remove and replace the battery packs. (See page 6, *Battery Packs*.)

NOTE. *Replace the Li-Ion battery packs only with TPSBAT battery packs.*

The Environmental Considerations section contains information on how to properly dispose of a Li-Ion battery pack. (See page xi, Environmental Considerations.)

To achieve optimum performance from a new battery pack, fully charge the battery pack. (See page 88, *Charging TPSBAT Battery Packs*.)

Reference

This chapter describes the menus and operating details associated with each front-panel menu button or control.

Acquire

Push the Acquire button to set acquisition parameters.

Options	Settings	Comments
Sample		Use to acquire and accurately display most waveforms; this is the default mode.
Peak Detect		Use to detect glitches and reduce the possibility of aliasing.
Average		Use to reduce random or uncorrelated noise in the signal display; the number of averages is selectable.
Averages	4, 16, 64, 128	Select number of averages.

Key Points

If you probe a noisy square wave signal that contains intermittent, narrow glitches, the waveform displayed will vary depending on the acquisition mode you choose.

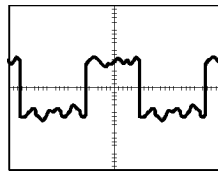

Sample

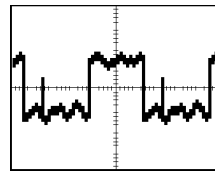

Peak Detect

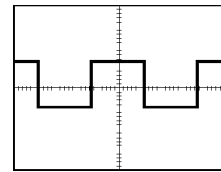

Average

Sample. Use Sample acquisition mode to acquire 2500 points and display them at the SEC/DIV setting. Sample mode is the default mode.

Sample acquisition intervals (2500)

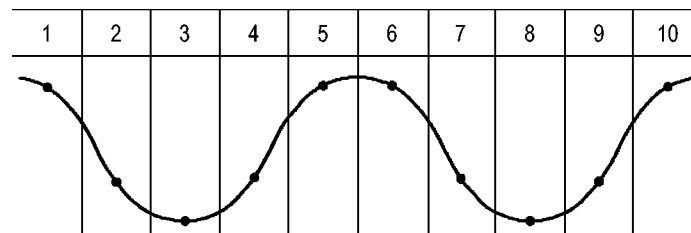

• Sample points

Sample mode acquires a single sample point in each interval.

The maximum sample rate is 1 GS/s for oscilloscope models with a bandwidth of 100 MHz and 2 GS/s for the 200 MHz model. At 100 ns and faster settings, this sample rate does not acquire 2500 points. In this case, a Digital Signal Processor interpolates points between the sampled points to make a 2500 point waveform record.

Peak Detect. Use Peak Detect acquisition mode to detect glitches as narrow as 10 ns and to limit the possibility of aliasing. This mode is effective when the Horizontal Scale setting is 5 μ s/div or slower.

Peak Detect acquisition intervals (1250)

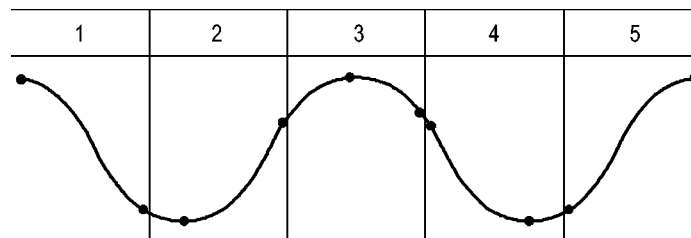

• Sample points displayed

Peak Detect mode displays the highest and lowest acquired voltage in each interval.

NOTE. If you set the Horizontal Scale setting to 2.5 μ s/div or faster, the acquisition mode changes to Sample because the sample rate is sufficiently fast to make Peak Detect unnecessary. The oscilloscope does not display a message to tell you that the mode was changed to Sample.

When there is enough waveform noise, a typical peak detect display shows large black areas. The oscilloscope displays this area with diagonal lines to improve display performance.



Typical peak detect display

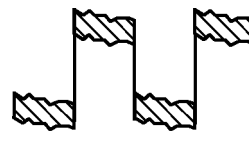

TPS2000B peak detect display

Average. Use Average acquisition mode to reduce random or uncorrelated noise in the signal you want to display. Data is acquired in sample mode, then a number of waveforms are averaged together.

Select the number of acquisitions (4, 16, 64, or 128) to average for the waveform.

Run/Stop Button. Push the **Run/Stop** button when you want the oscilloscope to continuously acquire waveforms. Push the button again to stop the acquisition.

Single Button. Push the **Single** button when you want the oscilloscope to acquire a single waveform and then stop. Each time you push the **Single** button, the oscilloscope begins to acquire another waveform. After the oscilloscope detects a trigger it completes the acquisition and stops.

Acquisition mode	Single button
Sample, Peak Detect	Sequence is complete when one acquisition is acquired.
Average	Sequence is complete when the defined number of acquisitions is reached; (See page 93, <i>Acquire</i> .)

Scan Mode Display. You can use the Horizontal Scan acquisition mode (also called Roll mode) to continuously monitor signals that change slowly. The oscilloscope displays waveform updates from the left to the right of the screen and erases old points as it displays new points. A moving, one-division-wide blank section of the screen separates the new waveform points from the old.

The oscilloscope changes to the Scan acquisition mode when you turn the Horizontal **Scale** knob to 100 ms/div or slower, and select the Auto Mode option in the Trigger Menu.

To disable Scan mode, push the **Trig Menu** button and set the Mode option to Normal.

Stopping the Acquisition. While the acquisition is running, the waveform display is live. Stopping the acquisition (when you push the **Run/Stop** button) freezes the display. In either mode, the waveform display can be scaled or positioned with the vertical and horizontal controls.

Application

You can use the **Application** button when an Application Key is inserted in the front of the oscilloscope, such as for power analysis. For more information, refer to the user manual for the application.

Autorange

When you push the **AutoRange** button, the oscilloscope activates or deactivates the Autorange function. An LED light turns on adjacent to the **AutoRange** button that indicates when the function is active.

This function automatically adjusts setup values to track a signal. If the signal changes, the setup continues to track the signal. When you power on the oscilloscope, autoranging is always inactive.

Options	Comment
Autoranging	Activates or deactivates the Autorange function; when activated the adjacent LED light turns on.
Vertical and Horizontal	Tracks and adjusts both axes.
Vertical Only	Tracks and adjusts the Vertical scale; does not change the horizontal settings.
Horizontal Only	Tracks and adjusts the Horizontal scale; does not change the vertical settings.

The following conditions cause autorange to adjust settings:

- Too many or too few waveform periods for a clear display of the trigger source (except when in Vertical Only)
- Waveform amplitude too large or too small (except when in Horizontal Only)
- Ideal trigger level changes

When you push the **AutoRange** button, the oscilloscope adjusts controls to produce a usable display of the input signal.

Function	Setting
Acquire mode	Sample
Display format	YT
Display persist	Off
Horizontal position	Adjusted
Horizontal view	Main
Run/Stop	Run
Horizontal Scale	Adjusted
Trigger coupling	DC
Trigger holdoff	Minimum
Trigger level	Adjusted
Trigger mode	Edge
Vertical bandwidth	Full
Vertical BW limit	Off
Vertical coupling	DC
Vertical invert	Off
Vertical Scale	Adjusted

The following changes to the setup of the oscilloscope deactivate autorange:

- Vertical Scale deactivates vertical autoranging
- Horizontal Scale deactivates horizontal autoranging
- Display or remove a channel waveform

- Trigger settings
- Single Seq acquisition mode
- Recall a setup
- XY Display format
- Persistence

The Autorange function is usually more useful than Autoset in the following situations:

- Analyzing a dynamically changing signal
- Quickly comparing a sequence of several signals without adjusting the oscilloscope. This is very useful if you need to use two probes at the same time, or if you need to use a probe in one hand and are holding something else in the other.
- Controlling which settings the oscilloscope automatically adjusts

If your signals vary in frequency, but have similar amplitudes, you can use Horizontal Only autoranging. The oscilloscope will adjust the horizontal settings, but leave the vertical settings unchanged. This way, you can visually estimate the amplitude of the signal without worrying about the vertical scale changing. Vertical Only autoranging works similarly, adjusting vertical parameters and leaving the horizontal settings unchanged.

Autoset

When you push the **AutoSet** button, the oscilloscope identifies the type of waveform and adjusts controls to produce a usable display of the input signal.

Function	Setting
Acquire mode	Adjusted to Sample or Peak Detect
Cursors	Off
Display format	Set to YT
Display type	Set to Dots for a video signal, set to Vectors for an FFT spectrum; otherwise, unchanged
Horizontal position	Adjusted
Horizontal Scale	Adjusted
Trigger coupling	Adjusted to DC, Noise Reject, or HF Reject
Trigger holdoff	Minimum
Trigger level	Set to 50%
Trigger mode	Auto
Trigger source	Adjusted; refer to the information after this table; cannot use Autoset on the EXT TRIG signal

Function	Setting
Trigger slope	Adjusted
Trigger type	Edge or Video
Trigger Video Polarity	Normal
Trigger Video Sync	Adjusted
Trigger Video Standard	Adjusted
Vertical bandwidth	Full
Vertical coupling	DC (if Ground was previously selected); AC for a video signal; otherwise, unchanged
Vertical Scale	Adjusted

The Autoset function examines all channels for signals and displays corresponding waveforms. Autoset also determines the trigger source based on the following conditions:

- If multiple channels have signals, the oscilloscope displays the channel with the lowest frequency signal.
- If no signals are found, then the oscilloscope displays the lowest-numbered channel when Autoset was invoked.
- If no signals are found and no channels are displayed, then the oscilloscope displays and uses channel 1.

When you use Autoset and the oscilloscope cannot determine the signal type, the oscilloscope adjusts the horizontal and the vertical scales, then takes the Mean and Pk-to-Pk automatic measurements.



The Autoset function is usually more useful than Autorange in the following situations:

- Troubleshooting one stable signal
- Automatically seeing measurements of your signal
- Easily changing how the signal is presented. For example, viewing only one cycle of the waveform, or the rising edge of the waveform
- Viewing video signals or FFT signals

Sine Wave





When you use the Autoset function and the oscilloscope determines that the signal is similar to a sine wave, the oscilloscope displays the following options:

Sine wave	Details
	Displays several cycles with appropriate vertical and horizontal scaling; the oscilloscope displays Cycle RMS, Frequency, Period, and Peak-to-Peak automatic measurements
Multi-cycle sine	

Sine wave	Details
 Single-cycle sine	Sets the horizontal scale to display about one cycle of the waveform; the oscilloscope displays Mean, and Peak-to-Peak automatic measurements
 FFT	Converts the input time-domain signal into its frequency components and displays the result as a graph of frequency versus magnitude (spectrum); because this is a mathematical calculation, refer to the <i>Math FFT</i> chapter for more information (See page 61, <i>Math FFT</i> .)
Undo Autoset	Causes the oscilloscope to recall the previous setup



Square Wave or Pulse



When you use the Autoset function and the oscilloscope determines that the signal is similar to a square wave or pulse, the oscilloscope displays the following options:

Square wave or	Details
 Multi-cycle square	Displays several cycles with appropriate vertical and horizontal scaling; the oscilloscope displays Pk-Pk, Mean, Period, and Frequency automatic measurements
 Single-cycle square	Sets the horizontal scale to display about one cycle of the waveform; the oscilloscope displays Min, Max, Mean, and Positive Width automatic measurements
 Rising edge	Displays the edge, and the Rise Time and Peak-to-Peak automatic measurements
 Falling edge	Displays the edge, and the Fall Time and Peak-to-Peak automatic measurements
Undo Autoset	Causes the oscilloscope to recall the previous setup

Video Signal

When you use the Autoset function and the oscilloscope determines that the signal is a video signal, the oscilloscope displays the following options:

Video signal options	Details
 Fields ► All Fields	Displays several fields and the oscilloscope triggers on any field
 Lines ► All Lines	Displays one complete line with parts of the previous and next line; the oscilloscope triggers on any line
 Lines ► Number	Displays one complete line with parts of the previous and next line; use the multipurpose knob to select a specific line number for the oscilloscope to use as a trigger

Video signal options	Details
 Odd Fields	Displays several fields and the oscilloscope triggers only on odd numbered fields
 Even Fields	Displays several fields and the oscilloscope triggers only on even numbered fields
Undo Autoset	Causes the oscilloscope to recall the previous setup

NOTE. Video autoset sets the Display Type option to Dots mode.

Cursor

Push the **Cursor** button to display the measurement cursors and Cursor Menu, and then use the multipurpose knob to change the position of a cursor.

Options	Settings	Comments
Type ¹	Time, Amplitude, Off	Select and display the measurement cursors; Time measures time, frequency, and amplitude; Amplitude measures amplitude, such as current or voltage
Source	Channels 1, 2, 3 ² , 4 ² , MATH, REFA, REFB, REFC ² , REFD ²	Choose the waveform on which to take the cursor measurements Cursor readouts display the measurement
Δ		Displays the absolute value of the difference (delta) between the cursors
Cursor 1 Cursor 2		Displays selected cursor location (time is referenced to the trigger position, and amplitude to the reference connection)

¹ For a Math FFT source, measures Frequency and Magnitude.

² Available only on a 4-channel oscilloscope.

Delta (Δ) values vary with the following types of cursors:

- Time cursors display Δt , $1/\Delta t$ and ΔV (or ΔI , ΔVV , and so on)
- Amplitude cursors, and Magnitude cursors (Math FFT source) display ΔV , ΔI , ΔVV , and so on
- Frequency cursors (Math FFT source) display $1/\Delta\text{Hz}$ and ΔdB

NOTE. *The oscilloscope must display a waveform for the cursors and cursor readouts to appear.*

NOTE. *The oscilloscope displays the time and amplitude values for each waveform when you use Time cursors.*

Key Points

Cursor Movement. Use the multipurpose knob to move Cursor 1 or Cursor 2. You can move the cursors only while the Cursor Menu is displayed. The active cursor is represented by a solid line.

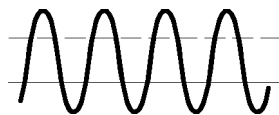

Amplitude cursors

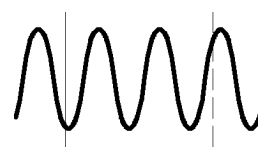

Time cursors

Default Setup

Push the **Default Setup** button to recall most of the factory option and control settings, but not all. Appendix E lists the default settings that will be recalled.

Display

Push the **Display** button to choose how waveforms are presented and to change the appearance of the entire display.

Options	Settings	Comments
Type	Vectors, Dots	Vectors fill the space between adjacent sample points in the display Dots display only the sample points
Persist	OFF, 1 sec, 2 sec, 5 sec, Infinite	Sets the length of time each displayed sample point remains displayed

Options	Settings	Comments
Format	YT, XY	YT format displays the vertical voltage in relation to time (horizontal scale) XY format displays a dot each time a sample is acquired on channel 1 and channel 2 Channel 1 voltage or current determines the X coordinate of the dot (horizontal) and the channel 2 voltage or current determines the Y coordinate (vertical)
Brightness		Makes it easier to distinguish a channel waveform from persistence Brightness controls the intensity of the display backlight. Adjust the brightness with the multipurpose knob.

Depending on the type, waveforms will be displayed in three different styles: solid, dimmed, and broken.

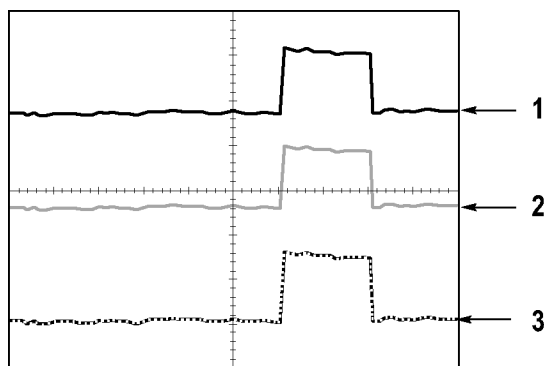

1. A solid waveform indicates a channel (live) waveform display. The waveform remains solid when the acquisition is stopped if no controls are changed that make the display accuracy uncertain.

Changing the vertical and horizontal controls is allowed on stopped acquisitions.

2. Reference waveforms appear white and waveforms with persistence applied appear in the same color as the Main waveform, but with less intensity.
3. A broken line indicates the waveform display no longer matches the controls. This happens when you stop the acquisition, and change a control setting that the oscilloscope is not able to apply to the displayed waveform. For example, changing the trigger controls on a stopped acquisition causes a broken-line waveform.

Key Points

Persistence. The oscilloscope displays persistence waveform data with less intensity than "live" waveform data. With Persistence set to Infinite, record points accumulate until a control is changed.

Option	Comments
Off	Removes default or old waveforms whenever new waveforms display
Time limit	Displays new waveforms at normal intensity and old waveforms at a lower intensity; erases old waveforms when they reach the time limit
Infinite	Older waveforms become less bright but always remain visible; use Infinite persistence to look for infrequent events and to measure long term peak-to-peak noise

XY Format. Use the XY format to analyze phase differences, such as those represented by Lissajous patterns. The format plots the voltage on channel 1 against the voltage on channel 2, where channel 1 is the horizontal axis and channel 2 is the vertical axis. The oscilloscope uses the untriggered Sample acquisition mode and displays data as dots. The sampling rate is fixed at 1 MS/s.

NOTE. *The oscilloscope can capture a waveform in normal YT mode at any sampling rate. You can view the same waveform in XY mode. To do so, stop the acquisition and change the display format to XY.*

In XY format, the controls operate as follows:

- The channel 1 Vertical Scale and Position controls set the horizontal scale (volts/div) and position.
- The channel 2 Vertical Scale and Position controls continue to set vertical scale (volts/div) and position.

The following functions do not work in XY display format:

- Autoset (resets display format to YT)
- Autorange
- Automatic measurements
- Cursors
- Reference or Math waveforms
- Save/Recall ► Save All
- Time base controls
- Trigger controls

Help

Push the **Help** button to display the Help menu. The topics cover all the menu options and controls of the oscilloscope. (See page xiv, *Help System*.)

Horizontal

You can use the horizontal controls to set up two views of a waveform, each with their own horizontal scale and position. The horizontal position readout shows the time represented by the center of the screen, using the time of the trigger as zero. When you change the horizontal scale, the waveform will expand or contract around the screen center.

Options	Comments
Main	The main horizontal time base setting is used to display the waveform
Window Zone	Two cursors define a window zone Adjust the Window Zone with the Horizontal Position and Scale controls
Window	Changes the display to show the waveform segment (expanded to screen width) within the window zone
Set Trigger Holdoff	Displays the holdoff value; push the option button and use the multipurpose knob to adjust

NOTE. *You can push the horizontal option buttons to switch between an entire waveform display and a zoomed part of it.*

A readout near the top right of the screen displays the current horizontal position in seconds. An **M** indicates the Main time base and a **W** indicates the Window time base. The oscilloscope also indicates horizontal position with an arrow icon at the top of the graticule.

Knobs and Buttons

Horizontal Position knob. Use to control the position of the trigger relative to the center of the screen.

The trigger point can be set to the left or the right of the center of the screen. The maximum number of divisions to the left depends on the Horizontal Scale (time base) setting. For most scales, the maximum is at least 100 divisions. Placing the trigger point off the screen to the left is called Delayed Sweep.

Set to Zero button. Use to set the horizontal position to zero.

Horizontal Scale knob. Use to change the horizontal time scale to magnify or compress the waveform.

Key Points **Scale.** If waveform acquisition is stopped (using the **Run/Stop** or **Single** button), the **Scale** control expands or compresses the waveform. Use to zoom in on a detail of the waveform.

Scan Mode Display (Roll Mode). When the **Scale** control is set to 100 ms/div or slower and the trigger mode is set to Auto, the oscilloscope enters the Scan acquisition mode. In this mode, the waveform display updates from left to right. There is no trigger or horizontal position control of waveforms during scan mode. (See page 95, *Scan Mode Display*.)

Window Zone. Use the Window Zone option to define a segment of a waveform to see in more detail (zoom). The Window time base setting cannot be set slower than the Main time base setting.

Vertical bars define Window Zone

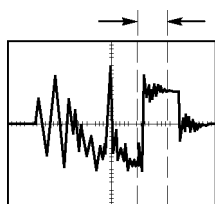

Main time base displayed

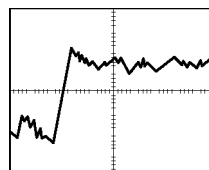

Window zone displayed

Window. Expands the Window Zone to cover the entire screen. Use to change between two time bases.

NOTE. When you change between the Main, Window Zone, and Window views, the oscilloscope erases any waveform saved on the screen through persistence. Persistence is erased with Horizontal menu changes.

Set Trigger Holdoff. Use holdoff to help stabilize the display of complex waveforms. (See page 117, *Trigger Holdoff*.)

Math

Push the **Math** button to display waveform math operations. Push the **Math** button again to remove math waveforms. (See page 120, *Vertical Controls*.)

Options	Comments
+, -, x, FFT	Math operations; see the next table
Sources	Sources used for the operations; see the next table

Options	Comments
Position	Use the multipurpose knob to set the vertical position of the resultant Math waveform
Vertical Scale	Use the multipurpose knob to set the vertical scale of the resultant Math waveform

The Math Menu includes Sources options for each operation.

Operation	Sources option	Comments
+ (addition)	CH1 + CH2	Channels 1 and 2 are added together
	CH3 + CH4 ¹	Channels 3 and 4 are added together
- (subtraction)	CH1 - CH2	The channel 2 waveform is subtracted from the channel 1 waveform
	CH2 - CH1	The channel 1 waveform is subtracted from the channel 2 waveform
	CH3 - CH4 ¹	The channel 4 waveform is subtracted from the channel 3 waveform
	CH4 - CH3 ¹	The channel 3 waveform is subtracted from the channel 4 waveform
× (multiplication)	CH1×CH2	Channels 1 and 2 are multiplied together
	CH3×CH4 ¹	Channels 3 and 4 are multiplied together
FFT	(See page 61.)	

¹ Available only on a 4-channel oscilloscope.

Key Points **Waveform Units.** The combination of source waveform units determine the resulting units for the Math waveform.

Waveform unit	Waveform unit	Operation	Resulting Math unit
V	V	+ or -	V
A	A	+ or -	A
V	A	+ or -	?
V	V	×	VV
A	A	×	AA
V	A	×	VA

Measure

Push the **Measure** button to access automatic measurements. There are eleven types of measurements available. You can display up to five at a time.

Push the top option button to display the Measure 1 Menu. You can choose the channel on which to take a measurement in the Source option. You can choose the type of measurement to take in the Type option. Push the Back option button to return to the Measure Menu and display the selected measurements.

Key Points **Taking Measurements.** You can display up to five automatic measurements at a time. The waveform channel must be on (displayed) to make a measurement.

Automated measurements cannot be taken on reference waveforms, or while using XY or scan mode. The measurements update about two times per second.

Measurement type	Definition
Freq	Calculates the frequency of the waveform by measuring the first cycle
Period	Calculates the time of the first cycle
Mean	Calculates the arithmetic mean amplitude over the entire record
Pk-Pk	Calculates the absolute difference between the maximum and minimum peaks of the entire waveform
Cyc RMS	Calculates a true RMS measurement of the first complete cycle of the waveform
Min	Examines the entire 2500 point waveform record and displays the minimum value
Max	Examines the entire 2500 point waveform record and displays the maximum value
Rise Time	Measures the time between 10% and 90% of the first rising edge of the waveform
Fall Time	Measures the time between 90% and 10% of the first falling edge of the waveform
Pos Width	Measures the time between the first rising edge and the next falling edge at the waveform 50% level
Neg Width	Measures the time between the first falling edge and the next rising edge at the waveform 50% level
None	Does not take any measurement

Print

When the **Save/Recall ► Save All ► Print Button** option is set to Prints, you can push the  print button to send the screen image to a printer or computer.

You can set up the oscilloscope to send a screen image to your printer through the **Utility ► Options ► Printer Setup** menu. (See page 72, *Printer Setup*.)

The alternative function of the  print button is to save data to the CompactFlash removable mass storage. (See page 81, *Removable Mass Storage*.)

Probe Check

You can use the Probe Check Wizard to quickly verify that your voltage probe is operating properly. (See page 11, *Voltage Probe Check Wizard*.)

Save/Recall

Push the **Save/Recall** button to save oscilloscope setups, screen images, or waveforms, or to recall oscilloscope setups or waveforms.

The Save/Recall menu is made up of many submenus which you can access through an Action option. Each Action option displays a menu that allows you to further define the save or recall function.

Action options	Comments
Save All	Contains the option that configures the  print button to send data to a printer or to save data to the CF card
Save Image	Saves a screen image to a file in a specified format
Save Setup	Saves the current oscilloscope settings to a file in a specified folder or in nonvolatile setup memory
Save Waveform	Saves the specified waveform to a file or to reference memory
Recall Setup	Recalls an oscilloscope setup file from a CF card or from a location in nonvolatile setup memory
Recall Waveform	Recalls a waveform file from a CF card to a location in reference memory
Display Refs	Displays or removes reference memory waveforms from the screen

Save All

The Save All action configures the  print button to save data to a CF card, or to send data to a printer.

Options	Settings or submenus	Comments
Print Button	Saves All to Files ¹	(See page 83.)
	Saves Image to File ¹	(See page 84.)
	Prints	(See page 71.)

Options	Settings or submenus	Comments
Select Folder		Lists the contents of the current CF card folder
	Change Folder	(See page 82, <i>File Management Conventions.</i>) (See page 119, <i>File Utilities.</i>)
	New Folder	(See page 82, <i>File Management Conventions.</i>) (See page 119, <i>File Utilities.</i>)
	Back	Returns to the Save All menu
About Save All		Displays the help topic

¹ An LED lights adjacent to the print button to indicate the alternative Save function that sends data to a CF card.

Save Image The Save Image action saves a screen image to a file in a specified format.

Options	Settings or submenus	Comments
File Format	BMP, PCX, TIFF, RLE, EPSIMAGE, JPEG	Sets the screen image graphics file format
Select Folder		Lists the contents of the current CF card folder and displays the folder options
	Change Folder	(See page 82, <i>File Management Conventions.</i>) (See page 119, <i>File Utilities.</i>)
	New Folder	(See page 82, <i>File Management Conventions.</i>) (See page 119, <i>File Utilities.</i>)
	Layout 1, Portrait, Landscape	Select portrait or landscape image layout
	Ink Saver ¹ , On, Off	Activates or deactivates Ink Saver mode
Save	filename (such as TEK0000.TIF)	Saves the screen image to the automatically generated file name in the current CF card folder
About Saving Images		Displays the help topic

¹ (See page 72, *Printer Setup.*)

When the print button option is set to Saves Image to File, the oscilloscope saves screen images to the CF card when you push the save button. (See page 84, *Saves Image to File.*)

Save Setup The Save Setup action saves the current oscilloscope settings to a file named TEKnxxx.SET in a specified folder, or in nonvolatile setup memory. A setup file contains an ASCII text string that lists the oscilloscope settings.

Options	Settings or submenus	Comments
Save To	Setup	Saves the current oscilloscope settings to a location in the nonvolatile setup memory
	File	Saves the current oscilloscope settings to a file on the CF card

Options	Settings or submenus	Comments
Setup	1 to 10	Specifies which nonvolatile setup memory location to save to
Select Folder		Lists the contents of the current CF card folder
	Change Folder	(See page 82, <i>File Management Conventions</i> .) (See page 119, <i>File Utilities</i> .)
	New Folder	
Save	filename (such as TEK0000.SET)	Saves the settings to the automatically generated file name in the current CF card folder

When the print button option is set to Saves All to Files, the oscilloscope saves oscilloscope setup files to the CF card when you push the save button. (See page 83, *Saves All to Files*.)

Save Waveform

The Save Waveform action saves the specified waveform to a file named TEKnmmn.CSV, or to reference memory. The oscilloscope saves waveform data to files as "comma separated values" (.CSV format), which are ASCII text strings that list the time (relative to the trigger) and amplitude values for each of the 2500 waveform data points. You can import .CSV files into many spreadsheet and math analysis applications.

Options	Settings or submenus	Comments
Save To	File	Specifies to save the source waveform data to a file on the CF card
	Ref	Specifies to save the source waveform data in reference memory
Source ¹	Channel(x), Ref(x), MATH	Specifies which source waveform to save
To	Ref(x)	Specifies the reference memory location in which to save the source waveform
Select Folder		Lists the contents of the current CF card folder
	Change Folder	(See page 82, <i>File Management Conventions</i> .) (See page 119, <i>File Utilities</i> .)
	New Folder	
Save	filename (such as TEK0000.CSV)	Saves the settings to the automatically generated file name in the current CF card folder

¹ Waveform must be displayed to save it as a reference waveform.

Recall Setup

The Recall Setup action recalls an oscilloscope setup file from a CF card or from a location in nonvolatile setup memory.

Options	Settings or submenus	Comments
Recall From	Setup	Specifies to recall a setup from the nonvolatile memory
	File	Specifies to recall a setup file from the CF card
Setup	1 to 10	Specifies which setup location in nonvolatile setup memory to recall
Select File		Lists the contents of the current CF card folder to select a file from
	Change Folder	(See page 82, <i>File Management Conventions</i> .) (See page 119, <i>File Utilities</i> .)
Recall		Recalls the settings from the specified nonvolatile memory location
	filename (such as TEK0000.SET)	Recalls the oscilloscope settings from the specified CF card file

Recall Waveform The Recall Waveform action recalls a waveform file from a CF card to a location in reference memory.

Options	Settings or submenus	Comments
To	Ref(x)	Specifies the reference memory location to load the waveform to
Select File		Lists the contents of the current CF card folder and displays the next folder option
	Change Folder	(See page 82, <i>File Management Conventions</i> .) (See page 119, <i>File Utilities</i> .)
	To	Specifies the reference memory location to recall the waveform to
Recall	filename (such as TEK0000.CSV)	Loads the waveform from the specified file to the location in reference memory and displays the waveform

Display Refs The Display Refs action displays or removes reference memory waveforms from the screen of the oscilloscope.

Options	Settings	Comments
RefA, RefB, RefC ¹ , RefD ¹	On, Off	Displays or removes reference memory waveforms from the screen

¹ Available only on a 4-channel oscilloscope.

Key Points **Saving and Recalling Setups.** The complete setup is stored in nonvolatile memory. When you recall the setup, the oscilloscope will be in the mode from which the setup was saved.

The oscilloscope saves the current setup if you wait three seconds after the last change before you power off the oscilloscope. The oscilloscope then recalls this setup the next time you apply power.

Recalling the Default Setup. You can push the **Default Setup** button to initialize the oscilloscope to a known setup. To view option and control settings that the oscilloscope recalls when you push this button, refer to *Appendix E: Default Setup*.

Saving and Recalling Waveforms. The oscilloscope must display any waveform that you want to save. Two-channel oscilloscopes can store two reference waveforms in internal nonvolatile memory. Four-channel oscilloscopes can store four, but only display two at a time.

The oscilloscope can display both reference waveforms and channel waveform acquisitions. Reference waveforms are not adjustable, but the oscilloscope displays the horizontal and vertical scales at the bottom of the screen.

Trigger Controls

You can define the trigger through the Trigger Menu and front-panel controls.

Trigger Types Three types of triggering are available: Edge, Video, and Pulse Width. A different set of options display for each type of trigger.

Option	Details
Edge (default)	Triggers the oscilloscope on the rising or falling edge of the input signal when it crosses the trigger level (threshold)
Video	Displays NTSC or PAL/SECAM standard composite video waveforms; you trigger on fields or lines of video signals. (See page 115, <i>Video Trigger</i> .)
Pulse	Triggers on aberrant pulses. (See page 115, <i>Pulse Width Trigger</i> .)

Edge Trigger Use Edge triggering to trigger on the edge of the oscilloscope input signal at the trigger threshold.

Options	Settings	Comments
Edge		With Edge highlighted, the rising or falling edge of the input signal is used for the trigger
Source	Channel 1, 2, 3 ¹ , or 4 ¹ , Ext, Ext/5, Ext/10	Select the input source as the trigger signal (See page 114.)
Slope	Rising, Falling	Select to trigger on either the rising or falling edge of the signal
Mode	Auto, Normal	Select the type of triggering (See page 113.)
Coupling	AC, DC, Noise Reject, HF Reject, LF Reject	Selects the components of the trigger signal applied to the trigger circuitry (See page 114.)

¹ Available only on a 4-channel oscilloscope.

Trigger Frequency Readout

The oscilloscope counts the rate at which triggerable events occur to determine trigger frequency and displays the frequency in the lower right corner of the screen.

NOTE. *The trigger frequency readout shows the frequency of events the oscilloscope might consider to be a trigger, and may be less than the frequency of the input signal in Pulse Width trigger mode.*

Key Points

Mode Options. The Auto mode (default) forces the oscilloscope to trigger when it does not detect a trigger within a certain amount of time based on the horizontal scale setting. You can use this mode in many situations, such as to monitor the level of a power supply output.

Use the Auto mode to let the acquisition free-run in the absence of a valid trigger. This mode allows an untriggered, scanning waveform at 100 ms/div or slower time base settings.

The Normal mode updates displayed waveforms only when the oscilloscope detects a valid trigger condition. The oscilloscope displays older waveforms until the oscilloscope replaces them with new ones.

Use the Normal mode when you want to see only valid triggered waveforms. When you use this mode, the oscilloscope does not display a waveform until after the first trigger.

To perform a Single Sequence acquisition, push the **Single** button.

Source Options.

Source option	Details
Channel 1, 2, 3 ¹ , or 4 ¹	Triggers on a channel whether or not the waveform is displayed
Ext	Does not display the trigger signal; the Ext option uses the signal connected to the Ext Trig front-panel BNC and allows a trigger level range of +4 V to -4 V
Ext/5	Same as the Ext option, but attenuates the signal by a factor of five, and allows a trigger level range of +20 V to -20 V; this extends the trigger level range
Ext/10	Same as the Ext option, but attenuates the signal by a factor of ten, and allows a trigger level range of +40 V to -40 V; this extends the trigger level range

¹ Available only on a 4-channel oscilloscope.

NOTE. To view an Ext, Ext/5, or Ext/10 trigger signal, push and hold down the **Trig View** button.

Coupling. Coupling allows you to filter the trigger signal used to trigger an acquisition.

Option	Details
DC	Passes all components of the signal
Noise Reject	Adds hysteresis to the trigger circuitry; this reduces sensitivity which reduces the chance of falsely triggering on noise
HF Reject	Attenuates the high-frequency components above 80 kHz
LF Reject	Blocks the DC component and attenuates the low-frequency components below 300 kHz
AC	Blocks DC components and attenuates signals below 10 Hz

NOTE. Trigger coupling affects only the signal passed to the trigger system. It does not affect the bandwidth or coupling of the signal displayed on the screen.

Pretrigger. The trigger position is typically set at the horizontal center of the screen. In this case, you are able to view five divisions of pretrigger information. Adjusting the Horizontal Position of the waveform allows you to see more or less pretrigger information.

Video Trigger

Options	Settings	Comments
Video		With Video highlighted, triggering occurs on an NTSC, PAL, or SECAM standard video signal Trigger coupling is preset to AC
Source	Channel 1, 2, 3 ¹ , or 4 ¹ , Ext, Ext/5, Ext/10	Selects the input source as the trigger signal; Ext, Ext/5, and Ext/10 selections use the signal applied to the Ext Trig connector
Polarity	Normal, Inverted	Normal triggers on the negative edge of the sync pulse; Inverted triggers on the positive edge of the sync pulse
Sync	All Lines, Line Number, Odd Field, Even Field, All Fields	Select an appropriate video sync Use the multipurpose knob to specify a line number when you select Line Number for the Sync option
Standard	NTSC, PAL/SECAM	Select the video standard for sync and line number count

¹ Available only on a 4-channel oscilloscope.

Key Points

Sync Pulses. When you choose Normal Polarity, the trigger always occurs on negative-going sync pulses. If your video signal has positive-going sync pulses, use the Inverted Polarity selection.

Pulse Width Trigger

Use Pulse Width triggering to trigger on normal or aberrant pulses.

Options	Settings	Comments
Pulse		With Pulse highlighted, triggering occurs on pulses that meet the trigger condition defined by the Source, When, and Set Pulse Width options
Source	Channel 1, 2, 3 ¹ , or 4 ¹ , Ext, Ext/5, Ext/10	Select the input source as the trigger signal
When	=, ≠, <, >	Select how to compare the trigger pulse relative to the value selected in the Pulse Width option
Pulse Width	33 ns to 10.0 sec	Use the multipurpose knob to set a width
Polarity	Positive, Negative	Select to trigger on positive or negative pulses
Mode	Auto, Normal	Select the type of triggering; Normal mode is best for most Pulse Width trigger applications

Options	Settings	Comments
Coupling	AC, DC, Noise Reject, HF Reject, LF Reject	Selects the components of the trigger signal applied to the trigger circuitry; (See page 112, <i>Edge Trigger</i> .)
More		Use to switch between submenu pages

¹ Available only on a 4-channel oscilloscope.

Trigger Frequency Readout

The oscilloscope counts the rate at which trigger events occur to determine trigger frequency and displays the frequency in the lower right corner of the screen.

Key Points

Trigger When. The pulse width of the source must be ≥ 5 ns for the oscilloscope to detect the pulse.

When options	Details
=	Triggers the oscilloscope when the signal pulse width is equal to or not equal to the specified pulse width within a $\pm 5\%$ tolerance
\neq	
<	Triggers the oscilloscope when the source signal pulse width is less than or greater than the specified pulse width
>	

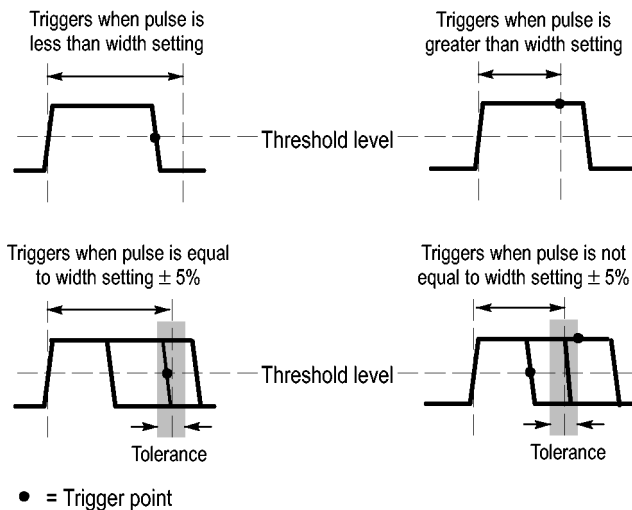

Refer to the *Application Examples* chapter for an example of triggering on aberrant pulses. (See page 54, *Triggering on a Specific Pulse Width*.)

Knobs and Buttons

Trigger Level knob. Use to control the Trigger Level.

Set to 50% button. Use the **Set to 50%** button to quickly stabilize a waveform. The oscilloscope automatically sets the Trigger Level to be about halfway between the minimum and maximum voltage levels. This is useful when you connect a signal to the Ext Trig BNC and set the trigger source to Ext, Ext/5, or Ext/10.

Force Trig Button. Use the **Force Trig** button to complete the current waveform acquisition whether or not the oscilloscope detects a trigger. This is useful for Single acquisitions and Normal trigger mode. (In Auto trigger mode, the oscilloscope automatically forces triggers periodically if it does not detect a trigger.)

Trig View button. Use the Trig View mode to display the conditioned trigger signal on the oscilloscope. You can use this mode to see the following types of information:

- Effects of the Trigger Coupling option
- Signal connected to the Ext Trig BNC

NOTE. *This is the only button that you must hold down to use. When you hold down the **Trig View** button, the only other button you can use is the  print button. The oscilloscope disables all other front-panel buttons. The knobs continue to be active.*

Trigger Holdoff. You can use the Trigger Holdoff function to produce a stable display of complex waveforms, such as pulse trains. Holdoff is the time between when the oscilloscope detects one trigger and when it is ready to detect another. The oscilloscope will not trigger during the holdoff time. For a pulse train, you can adjust the holdoff time so the oscilloscope triggers only on the first pulse in the train.

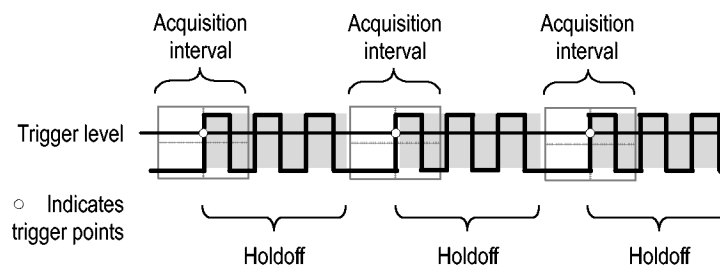

Triggers are not recognized during holdoff time.

To use Trigger Holdoff, push the **Horiz ► Set Trigger Holdoff** option button and use the multipurpose knob to adjust the holdoff. The resolution of the trigger holdoff varies depending on the Horizontal Scale setting.

Utility

Push the **Utility** button to display the Utility Menu.

Options	Settings	Comments
System Status		Summary of the oscilloscope settings
Options	Front Panel Backlight	Enables Illumination of the front panel
	Printer Setup	Displays the setup for the printer (See page 72, <i>Printer Setup</i> .)
	RS232 Setup	Displays the setup for the RS-232 port (See page 73.)
	Set Date and Time	Sets the date and time (See page 118.)
	Error Log	Displays a list of any errors logged and the Power Cycle count This log is useful if you contact a Tektronix Service Center for help.
Do Self Cal		Performs a self calibration
File Utilities		Displays folder, file, and CF card options (See page 119.)
Language	English, French, German, Italian, Spanish, Japanese, Portuguese, Simplified Chinese, Traditional Chinese, Korean	Selects the display language of the oscilloscope

Key Points **System Status.** Selecting System Status from the Utility Menu displays the menus available for obtaining a list of control settings for each group of oscilloscope controls.

Push any front-panel menu button to remove the status screen.

Options	Comments
Horizontal	Lists horizontal parameters
Vertical	Lists vertical parameters of channels
Trigger	Lists trigger parameters
Misc	Lists the model of the oscilloscope, the version number of the software, and the serial number
	Lists the charge status of the battery packs
	Lists values of the communications parameters

Setting the Date and Time. You can use the Set Date and Time menu to set the clock date and time. The oscilloscope displays this information, and also uses it to time stamp files written to the CF card. The oscilloscope contains a built-in nonreplaceable battery to maintain the clock settings.

The clock does not automatically adjust for seasonal time changes. The calendar does adjust for Leap years.

Options	Comments
↑	Moves the field selection highlight up or down through the list. Use the multipurpose knob to change the value of the selected field
↓	
Set Date and Time	Updates the oscilloscope with the specified date and time
Cancel	Closes the menu and returns to the previous menu without saving any changes

Self Calibration. The Do Self Cal (self calibration) routine optimizes the oscilloscope accuracy for the ambient temperature. For maximum accuracy, perform a self calibration if the ambient temperature changes by 5 °C (9 °F) or more. For accurate calibration, power on the oscilloscope and wait twenty minutes to ensure it is warmed up. Follow the directions on the screen.

Factory calibration uses externally-generated voltages, and requires specialized equipment. The recommended interval is one year. See *Contacting Tektronix* on the copyright page for information on having Tektronix perform a Factory Calibration of your oscilloscope.

File Utilities

You can use the File Utilities menu to do the following tasks:

- List the contents of the current folder
- Select a file or folder
- Navigate to other folders
- Create, rename, and delete files and folders
- Format the CF card

Options	Comments
Change Folder	Navigates to the selected CF card folder. Use the multipurpose knob to select a file or folder, then select the Change Folder menu option to navigate to the selected folder. To return to the previous folder, select the ↑Up folder item and then select the Change Folder menu option.
New Folder	Creates a new folder in the current folder location, named NEW_FOL, and displays the Rename menu for changing the default folder name.
Rename (filename or folder)	Displays the Rename screen to rename a folder or file, described next.
Delete (filename or folder)	Deletes the selected file name or folder; a folder must be empty before you can delete it.
Confirm Delete	Displays after pressing Delete, to confirm a file delete action. Pressing any button or knob other than Confirm Delete cancels the file delete action.

Options	Comments
Format	Formats the CF card; this deletes all data on the CF card
Update Firmware	Follow the on-screen directions to set up and push the Update Firmware option button to start updating firmware.

Rename File or Folder. You can change the names of files and folders on the CF card.

Option	Settings	Comments
Enter Character	A - Z, 0 - 9, _ , .	Enters the highlighted alphanumeric character at the current Name field cursor position
		Use the multipurpose knob to select an alphanumeric character or the Backspace, Delete Character, or Clear Name functions
	Backspace	Changes the menu button 1 option to the Backspace function. Deletes the character to the left of the highlighted character in the Name field
	Delete Character	Changes the menu button 1 option to the Delete Character function. Deletes the highlighted character from the Name field
	Clear Name	Changes the menu button 1 option to Clear Name. Deletes all characters from the Name field

Vertical Controls

You can use the vertical controls to display and remove waveforms, adjust vertical scale and position, set input parameters, and for vertical math operations. (See page 105, *Math*.)

Channel Vertical Menus

There is a separate vertical menu for each channel. Each option is set individually for each channel.

Options	Settings	Comments
Coupling	DC, AC, Ground	DC passes both AC and DC components of the input signal AC blocks the DC component of the input signal and attenuates signals below 10 Hz Ground disconnects the input signal

Options	Settings	Comments
BW Limit	20 MHz, Off	Limits the bandwidth to reduce display noise; filters the signal to reduce noise and other unwanted high frequency components
Volts/Div	Coarse, Fine	Selects the resolution of the Scale knob Coarse defines a 1-2-5 sequence. Fine changes the resolution to small steps between the coarse settings
Probe	See the next table	Push to adjust Probe options
Invert	On, Off	Inverts (flips) the waveform with respect to the reference level

The option for voltage and current probes is different: Attenuation or Scale.

Probe options	Settings	Comments
Voltage ► Attenuation	1X, 10X, 20X, 50X, 100X, 500X, 1000X	Set to match the attenuation factor of the voltage probe to ensure correct vertical readouts
Current ► Scale	5 V/A, 1 V/A, 200 mV/A, 100 mV/A, 50 mV/A, 20 mV/A, 10 mV/A, 1 mV/A	Set to match the scale of the current probe to ensure correct vertical readouts
Back		Returns to the previous menu

Knobs **Vertical Position knobs.** Use the vertical **Position** knobs to move the channel waveforms up or down on the screen.

Vertical Scale knobs. Use the vertical **Scale** knobs to control how the oscilloscope amplifies or attenuates the source signal of channel waveforms. When you turn a vertical **Scale** knob, the oscilloscope increases or decreases the vertical size of the waveform on the screen.

Vertical Measurement Overrange (Clipping). Waveforms that extend beyond the screen (overrange) and display a ? in the measurement readout indicates an invalid value. Adjust the vertical scaling to ensure the readout is valid.

Key Points **Ground Coupling.** Use Ground coupling to display a zero-volt waveform. Internally, the channel input is connected to a zero-volt reference level.

Fine Resolution. The vertical scale readout displays the actual volts/division setting while in the fine resolution setting. Changing the setting to coarse does not change the vertical scale until the **Scale** control is adjusted.

Remove Waveform. To remove a waveform from the display, push a channel menu front panel button. For example, push the Channel 1 button to display or remove the channel 1 waveform.

NOTE. *You do not have to display a channel waveform to use it as a trigger source or for math operations.*

NOTE. *You must display a channel waveform to take measurements from it, use cursors on it, or to save it as a Reference waveform or to a file.*

Appendix A: TPS2000B Specifications

All specifications apply to the TPS2000B series oscilloscopes. TPP0101 and TPP0201 probe specifications appear at the end of this chapter. To verify that the oscilloscope meets specifications, the oscilloscope must first meet the following conditions:

- The oscilloscope must have been operating continuously for twenty minutes within the specified operating temperature.
- You must perform the Do Self Cal operation, accessible through the Utility menu, if the operating temperature changes by more than 5 °C (9 °F).
- The oscilloscope must be within the factory calibration interval.

All specifications are guaranteed unless noted “typical.”

Oscilloscope Specifications

Table 1: Acquisition Specifications

Characteristics	Description
Acquisition Modes	Sample, Peak Detect, and Average
Acquisition Rate, typical	Up to 180 waveforms per second, per channel (Sample acquisition mode, no measurements)
Single Sequence	<i>Acquisition Mode</i>
	<i>Acquisition Stops After</i>
	Sample, Peak Detect
Average	N acquisitions, all channels simultaneously, N is selectable from 4, 16, 64, and 128

Table 2: Input Specifications

Characteristics	Description
Input Coupling	DC, AC, or Ground
Input Impedance, DC Coupled	1 MΩ ±2% in parallel with 20 pF ±3 pF
Maximum Voltage Between Signal and Reference at input BNC ¹	<i>Overvoltage Category</i>
	<i>Maximum Voltage</i>
	CAT II
	300 V _{RMS}
	Derate at 20 dB/decade above 100 kHz to 13 V peak AC at 3 MHz and above. For non-sinusoidal waveforms, peak value must be less than 450 V. Excursion above 300 V should be less than 100 ms duration. RMS signal level including any DC component removed through AC coupling must be limited to 300 V. If these values are exceeded, damage to the instrument may result. Refer to the Overvoltage Category description.
Maximum Voltage Between BNC Reference and Earth Ground ¹	600 V _{RMS} CAT II, using rated connectors or accessories

Table 2: Input Specifications (cont.)

Characteristics	Description	
Channel Common Mode Rejection, typical	Greater than 1000:1, up to 50 MHz, derated to 400:1 at 200 MHz, sinewave, with Volts/Div setting at 5 mV	
	With the signal applied between the channel (signal and signal reference) to chassis, the ratio of the acquired signal amplitude to the amplitude of the signal	
Channel-to-Channel Crosstalk	<i>TPS2012B and TPS2014B</i>	<i>TPS2024B</i>
	≥ 100:1 at 50 MHz	≥ 100:1 at 100 MHz
	Measured on one channel, with test signal applied between signal and reference of the other channel, and with the same Scale and coupling settings on each channel	

¹ The maximum peak-to-peak voltage that can be displayed is 40 V_{P-P} with a 1X attenuation. The Vertical specifications include available volts/div and probe attenuation settings. (See Table 3.)

Table 3: Vertical Specifications

Characteristics	Description	
Digitizers	8-bit resolution (except when set to 2 mV/div), each channel sampled simultaneously	
Vertical Scale (Volts/Div) Range	2 mV/div to 5 V/div at input BNC	
Position Range	2 mV/div to 200 mV/div, ±1.8 V > 200 mV/div to 5 V/div, ±45 V	
TPP0101 and TPP0201 Probe Attenuation	10X	
Supported Voltage Probe Attenuation Factors	1X, 10X, 20X, 50X, 100X, 500X, 1000X	
Supported Current Probe Scales	5 V/A, 1 V/A, 200 mV/A, 100 mV/A, 50 mV/A, 20 mV/A, 10 mV/A, 1 mV/A	
Analog Bandwidth in Sample and Average modes at BNC or with TPP0101 or TPP0201 series 10X probe, DC Coupled	<i>TPS2012B and TPS2014B</i> 100 MHz ¹	<i>TPS2024B</i> 200 MHz ¹ from 0 °C to +40 °C (+32 °F to +104 °F) 180 MHz from +40 °C to +50 °C (+ 104°F to +122 °F)
Analog Bandwidth in Peak Detect mode (50 s/div to 5 ms/div ²), typical	75 MHz ¹ 20 MHz (when vertical scale is set to < 5 mV)	
Selectable Analog Bandwidth Limit, typical	20 MHz	
Lower Frequency Limit, AC Coupled	≤ 10 Hz at BNC ≤ 1 Hz when using a 10X passive probe	
Rise Time at BNC, typical	<i>TPS2012B and TPS2014B</i> < 3.5 ns	<i>TPS2024B</i> < 2.1 ns
Peak Detect Response ²	Captures 50% or greater amplitude of pulses ≥12 ns wide typical (50 s/div to 5 μs/div) in the center 8 vertical divisions	

Table 3: Vertical Specifications (cont.)

Characteristics	Description	
DC Gain Accuracy	$\pm 3\%$ for Sample or Average acquisition mode, 5 V/div to 10 mV/div	
	$\pm 4\%$ for Sample or Average acquisition mode, 5 mV/div and 2 mV/div	
DC Measurement Accuracy, Average Acquisition Mode	<i>Measurement Type</i>	<i>Accuracy</i>
	Average of ≥ 16 waveforms with vertical position at zero	$\pm(3\% \times \text{reading} + 0.1 \text{ div} + 1 \text{ mV})$ when 10 mV/div or greater is selected
	Average of ≥ 16 waveforms with vertical position <u>not</u> at zero	$\pm[3\% \times (\text{reading} + \text{vertical position}) + 1\% \text{ of vertical position} + 0.2 \text{ div}]$ Add 2 mV for settings from 2 mV/div to 200 mV/div Add 50 mV for settings from > 200 mV/div to 5 V/div
Volts Measurement Repeatability, Average Acquisition Mode	Delta volts between any two averages of ≥ 16 waveforms acquired under same setup and ambient conditions	$\pm(3\% \times \text{reading} + 0.05 \text{ div})$

¹ When the vertical scale is set to > 5 mV/div. When the vertical scale is set to 5 mV/div, the bandwidth specification is typical.

² The oscilloscope reverts to Sample mode when the SEC/DIV (horizontal scale) is set from 2.5 $\mu\text{s}/\text{div}$ to 5 ns/div on 100 MHz models, or from 2.5 $\mu\text{s}/\text{div}$ to 2.5 ns/div on a TPS2024B model. Sample mode can capture 12 ns glitches.

Table 4: Horizontal Specifications

Characteristics	Description	
Sample Rate Range	<i>TPS2012B and TPS2014B</i>	<i>TPS2024B</i>
	5 S/s to 1 GS/s	5 S/s to 2 GS/s
Waveform Interpolation	$(\sin x)/x$	
Record Length	2500 samples for each channel	
Horizontal Scale (Sec/Div) Range	<i>TPS2012B and TPS2014B</i>	<i>TPS2024B</i>
	5 ns/div to 50 s/div, in a 1, 2.5, 5 sequence	2.5 ns/div to 50 s/div, in a 1, 2.5, 5 sequence
Sample Rate and Delay Time Accuracy	± 50 ppm over any ≥ 1 ms time interval	
Delta Time Measurement Accuracy (Full Bandwidth)	<i>Conditions</i>	<i>Accuracy</i>
	Single-shot, Sample mode	$\pm(1 \text{ sample interval} + 100 \text{ ppm} \times \text{reading} + 0.6 \text{ ns})$
	> 16 averages	$\pm(1 \text{ sample interval} + 100 \text{ ppm} \times \text{reading} + 0.4 \text{ ns})$
	Sample interval = $s/\text{div} \div 250$	
Position Range	2.5 ns/div to 10 ns/div	$(-4 \text{ div} \times s/\text{div})$ to 20 ms
	25 ns/div to 100 $\mu\text{s}/\text{div}$	$(-4 \text{ div} \times s/\text{div})$ to 50 ms
	250 $\mu\text{s}/\text{div}$ to 10 s/div	$(-4 \text{ div} \times s/\text{div})$ to 50 s
	25 s/div to 50 s/div	$(-4 \text{ div} \times s/\text{div})$ to 250 s

Table 5: Trigger Specifications

Characteristics	Description	
Trigger Sensitivity, Edge Trigger Type	<i>Coupling</i>	<i>Sensitivity</i>
	DC	CH1, CH2, CH3 ¹ , CH4 ¹
		1 div from DC to 10 MHz
		1.5 div from 10 MHz to 100 MHz
		2 div from 100 MHz to 200 MHz ²
	EXT	1 V _{P-P} from 50 Hz to 100 MHz
	2 V _{P-P} from 100 MHz to 200 MHz ²	
	EXT/5	5X the value of EXT
	EXT/10	10X the value of EXT
Trigger Sensitivity, Edge Trigger Type, typical	<i>Coupling</i>	<i>Sensitivity</i>
	AC	Same as DC-coupled limits from 50 Hz and above
	NOISE REJ	Reduces the DC-coupled trigger sensitivity by 2 times for > 10 mv/div to 5 V/div
	HF REJ	Same as the DC-coupled limit from DC to 7 kHz, attenuates signals above 80 kHz
	LF REJ	Same as the DC-coupled limits for frequencies above 300 kHz, attenuates signals below 300 kHz
Trigger Level Range	<i>Source</i>	<i>Range</i>
	CH1, CH2, CH3 ¹ , CH4 ¹	±8 divisions from center of screen
	EXT	±4 V
	EXT/5	±20 V
	EXT/10	±35 V
Trigger Level Accuracy, typical	Accuracies are for signals having rise and fall times ≥20 ns	
	<i>Source</i>	<i>Accuracy</i>
	Internal	±(0.2 div + 5 mV) within ±4 divisions from the center of the screen
	EXT	±(6% of setting + 250 mV) for signals < ±2 V
	EXT/5	±(6% of setting + 500 mV) for signals < ±10 V
	EXT/10	±(6% of setting + 1 V) for signals < ±20 V
Set Level to 50%, typical	Operates with input signals ≥ 50 Hz	
Default Settings, Video Trigger	Coupling is AC and Auto mode except for a single sequence acquisition	
Sensitivity, Video Trigger Type, typical	Composite video signal	
	<i>Source</i>	<i>Range</i>
	Internal	Pk-pk amplitude of 2 divisions
	EXT	±1 V
	EXT/5	±5 V
	EXT/10	±10 V

Table 5: Trigger Specifications (cont.)

Characteristics	Description
Signal Formats and Field Rates, Video Trigger Type	Supports NTSC, PAL, and SECAM broadcast systems for any field or any line
Holdoff Range	500 ns to 10 s

¹ Available only on a 4-channel oscilloscope.

² TPS2024B only.

Table 6: Pulse Width Trigger Specifications

Characteristics	Description
Pulse Width Trigger modes	Trigger when < (Less than), > (Greater than), = (Equal), or ≠ (Not Equal); Positive pulse or Negative pulse
Pulse Width Trigger Point	Equal: The oscilloscope triggers when the trailing edge of the pulse crosses the trigger level. Not Equal: If the pulse is narrower than the specified width, the trigger point is the trailing edge. Otherwise, the oscilloscope triggers when a pulse continues longer than the time specified as the Pulse Width. Less than: The trigger point is the trailing edge. Greater than (also called time-out trigger): The oscilloscope triggers when a pulse continues longer than the time specified as the Pulse Width.
Pulse Width Range	Selectable from 33 ns to 10 s
Pulse Width Resolution	16.5 ns or 1 part per thousand, whichever is larger
Equal Guardband	$t > 330 \text{ ns}$: $\pm 5\% \leq \text{guardband} < \pm(5.1\% + 16.5 \text{ ns})$ $t \leq 330 \text{ ns}$: guardband = $\pm 16.5 \text{ ns}$
Not Equal Guardband	$t > 330 \text{ ns}$: $\pm 5\% \leq \text{guardband} < \pm(5.1\% + 16.5 \text{ ns})$ $165 \text{ ns} < t \leq 330 \text{ ns}$: guardband = $-16.5 \text{ ns} \div +33 \text{ ns}$ $t \leq 165 \text{ ns}$: guardband = $\pm 16.5 \text{ ns}$

Table 7: Trigger Frequency Counter Specifications

Characteristics	Description
Readout Resolution	6 digits
Accuracy (typical)	± 51 parts per million including all frequency reference errors and ± 1 count errors
Frequency Range	AC coupled, 10 Hz minimum to rated bandwidth
Signal Source	Pulse Width or Edge Trigger modes: all available trigger sources The Frequency Counter measures trigger source at all times in Pulse Width or Edge modes, including when the oscilloscope acquisition is halted due to changes in the run status, or acquisition of a single shot event has completed. Pulse Width Trigger mode: The oscilloscope counts pulses of significant magnitude inside the 250 ms measurement window that qualify as triggerable events, such as narrow pulses in a PWM pulse train if set to < mode and the width is set to a relatively small time. Edge Trigger mode: The oscilloscope counts all edges of sufficient magnitude and correct polarity. Video Trigger mode: The Frequency Counter does not operate.

Table 8: Measurement Specifications

Characteristics	Description
Cursors	Amplitude difference between cursors (ΔV , ΔA , or ΔVA)
	Time difference between cursors (Δt)
	Reciprocal of Δt in Hertz ($1/\Delta t$)
Automatic Measurements	Frequency, Period, Mean, Pk-Pk, Cycle RMS, Min, Max, Rise Time, Fall Time, Pos Width, Neg Width

Table 9: Oscilloscope General Specifications

Characteristic	Description
Display	
Display Type	5.7 in. (145 mm) diagonal liquid crystal
Display Resolution	320 horizontal by 240 vertical pixels
Backlight Intensity, typical ¹	60 to 100 cd/m ²

Table 9: Oscilloscope General Specifications (cont.)

Characteristic	Description	
Probe Compensator Output		
Output Voltage, typical	5 V into $\geq 1\text{ M}\Omega$ load	
Frequency, typical	1 kHz	
Power Source		
Source Voltage of the Oscilloscope AC Adapter	100 to 240 VAC _{RMS} 50/60 Hz	
Power Consumption	Less than 40 W	
Environmental		
Enclosure Rating	IP 40 ² except when the CompactFlash card and optional Application key are installed, the rating becomes IP 30 ² .	
Temperature ³	Operating	0 °C to +50 °C (+32 °F to +122 °F)
	Nonoperating	-40 °C to +71 °C (-40 °F to +160 °F)
Cooling Method	Forced air, temperature controlled	
Humidity ³	Operating	High: +50 °C (+122 °F), 60% RH Low: +30 °C (+86 °F), 90% RH
	Nonoperating	High: +55 °C to +71 °C (+131 °F to +160 °F), 60% RH max. Low: 0°C to +30 °C(+32 °F to +86 °F), $\leq 90\%$ RH max.
Altitude	3,000 m (9,842 ft)	
Random Vibration with one battery pack	Operating	0.31 g _{RMS} from 5 Hz to 500 Hz, 10 minutes on each axis
	Nonoperating	2.46 g _{RMS} from 5 Hz to 500 Hz, 10 minutes on each axis
Mechanical Shock with one battery pack	Operating	50 g, 11 ms, half sine
Mechanical		
Size, without front protection cover	Height	160.0 mm (6.33 in.)
	Width	336.3 mm (13.24 in.)
	Depth	129.5 mm (5.10 in.)
Weight (approximate)	Instrument only	2.7 kg (6.0 lbs)
	With 1 battery	3.2 kg (7.0 lbs)
	With 2 batteries	3.7 kg (8.0 lbs)

Table 9: Oscilloscope General Specifications (cont.)

Characteristic	Description
Adjustment (Factory Calibration) Interval	
The recommended calibration interval is one year	

¹ Adjustable through the Display menu.

² As defined in IEC 60529: 2001.

³ When a battery pack is installed, refer to the *Managing TPSBAT Battery Packs* section for information on the charge, discharge and storage temperatures, and on the humidity. (See page 85.)

Appendix B: TPP0101 and TPP0201 Series 10X Passive Probes Information

The TPP0101 & TPP0201 Series 100 and 200 MHz Passive Probes are high impedance, passive probes with 10X attenuation that are designed for use with the following Tektronix oscilloscopes:

- TPS2000B and TDS2000C oscilloscopes that have 20 pF of input capacitance. The compensation range of these probes is 15 – 25 pF.

The probes have no user- or Tektronix-serviceable parts.



WARNING. Do not float these probes (TPP0101 and TPP0201 Series) on any oscilloscope except TPS2000 and TPS2000B Series Oscilloscopes.

Do not float the reference lead of these probes to $>30 V_{RMS}$ when used with a TPS2000 or TPS2000B Series Oscilloscope. Use either the P5120 probe (floatable to 600 V_{RMS} CAT II), a similarly-rated passive high voltage probe, or an appropriately-rated high voltage differential probe when floating the reference lead above 30 V_{RMS} , subject to the ratings of the high voltage probe used.

Connecting the Probe to the Oscilloscope

Connect the probe as shown in the illustrations below.

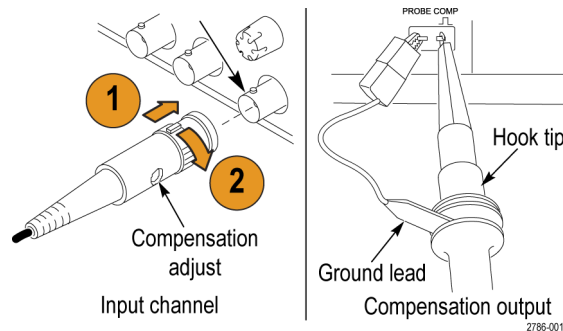

Compensating the Probe

Due to variations in oscilloscope input characteristics, the low-frequency compensation of the probe may need adjustment after moving the probe from one oscilloscope channel to another.

If a 1 kHz calibrated square wave displayed at 1 ms/division shows significant differences between the leading and trailing edges, perform the following steps to optimize low-frequency compensation:

1. Connect the probe to the oscilloscope channel that you plan to use for your measurements.
2. Connect the probe to the probe compensation output terminals on the oscilloscope front panel.



WARNING. To avoid electric shock, only connect to the Probe Comp signal on the oscilloscope when making this adjustment.

3. Push **Autoset** or otherwise adjust your oscilloscope to display a stable waveform.
4. Adjust the trimmer in the probe until you see a perfectly flat-top square wave on the display. (See illustration.)



WARNING. To avoid electric shock, only use the insulated adjustment tool when making compensation adjustments.

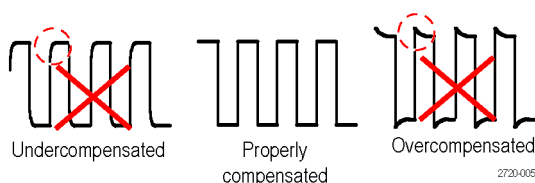

Connecting the Probe to the Circuit

Use the standard accessories included with the probe to connect to your circuit.



WARNING. To avoid electric shock when using the probe or accessories, keep fingers behind the finger guard of the probe body and accessories.

To reduce risk of shock, ensure the ground lead and ground spring are fully mated before connecting the probe to the circuit under test.

Standard Accessories

The accessories included with the probe are shown below.

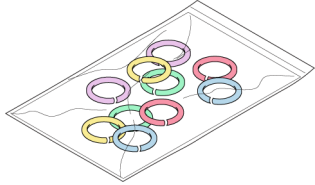
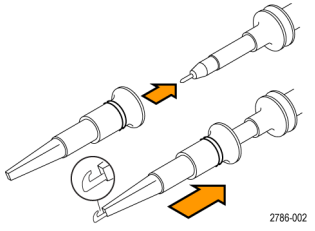
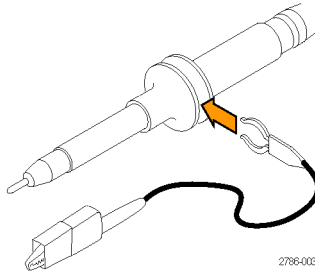
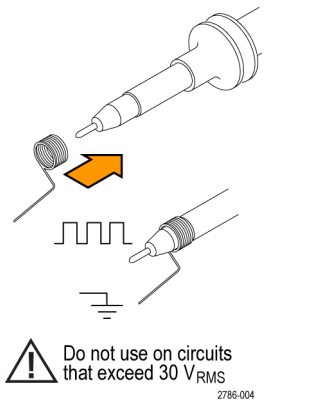
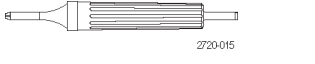
Item	Description
	<p>Color bands</p> <p>Use these bands to identify the oscilloscope channel at the probe head.</p> <p>Reorder Tektronix part number 016-0633-xx (5 pairs)</p>
 <p style="text-align: right; font-size: small;">2786-002</p>	<p>Hook tip</p> <p>Press the hook tip onto probe tip and then clamp the hook onto the circuit.</p> <p>Reorder Tektronix part number 013-0362-xx</p>
 <p style="text-align: right; font-size: small;">2786-003</p>	<p>Ground lead, with alligator clip</p> <p>Secure the lead to the probe head ground and then to your circuit ground.</p> <p>Reorder Tektronix part number 196-3521-xx</p>
 <p style="text-align: right; font-size: small;">2786-004</p> <p>Do not use on circuits that exceed 30 V_{RMS}</p>	<p>Ground spring</p> <p>The ground spring minimizes aberrations on high-frequency signals caused by the inductance of the ground path, giving you measurements with good signal fidelity.</p> <p>Attach the spring to the ground band on the probe tip. You can bend the spring out to ~0.75 in. away from the signal test point.</p> <p>Reorder Tektronix part number 016-2028-xx (2 ea.)</p>
 <p style="text-align: right; font-size: small;">2720-015</p>	<p>Adjustment tool</p> <p>Reorder Tektronix part number 003-1433-xx</p>

Optional Accessories

You can order the following accessories for your probe.

Accessory	Part number
Alligator Ground Lead, 12 in	196-3512-xx
6" Clip-on Ground Lead	196-3198-xx
Ground Spring, Short, 2 ea.	016-2034-xx
MicroCKT Test Tip	206-0569-xx
Micro Hook Tip	013-0363-xx
Universal IC Cap	013-0366-xx
Circuit Board Test Point/PCB Adapter	016-2016-xx
Wire, spool, 32 AWG	020-3045-xx

Specifications

Table 10: Electrical and mechanical specifications

Characteristic	TPP0101	TPP0201
Bandwidth (-3 dB)	DC to 100 MHz	DC to 200 MHz
System attenuation accuracy	10:1 \pm 3.2%	10:1 \pm 3.2%
Compensation range	TPP0101: 15 pF – 25 pF	TPP0201: 15 pF – 25 pF
System input resistance @ DC	10 M Ω \pm 1.5%	10 M Ω \pm 1.5%
System input capacitance	<12 pF	<12 pF
System rise time (typical)	<3.5 ns	<2.3 ns
Propagation delay	~6.1 ns	~6.1 ns
Maximum input voltage	300 V _{RMS} CAT II	300 V _{RMS} CAT II
Cable length	1.3 m	1.3 m

Table 11: Environmental specifications

Characteristics	Description
Temperature	
Operating	-10 °C to +55 °C (14 °F to +131 °F)
Nonoperating	-51 °C to +71 °C (-60 °F to +160 °F)
Humidity	
Operating and Non-Operating	5% to 95% relative humidity (%RH) up to +30 °C (86 °F), 5% to 65% RH above +30 °C up to +55 °C (131 °F)
Altitude	
Operating	3.0 km (10,000 ft) maximum
Nonoperating	12.2 km (40,000 ft) maximum

Performance Graphs

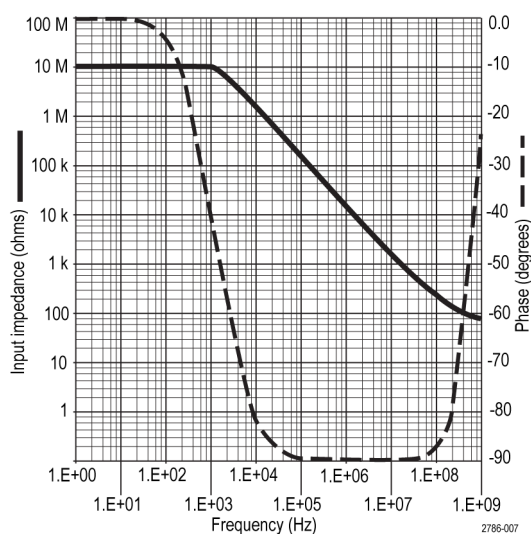
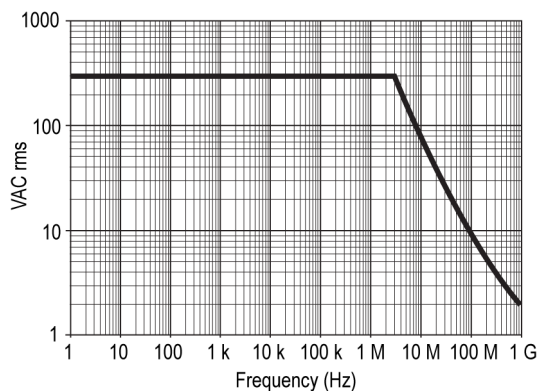

Table 12: Certifications and compliances

Characteristics	Description
EC Declaration of Conformity	Compliance was demonstrated to the following specification as listed in the Official Journal of the European Communities: Low Voltage Directive 2006/95/EC: EN61010-031: 2002
Safety Standards	UL61010-031:2007 CAN/CSA C22.2 No. 61010-031-07 IEC61010-031; IEC 61010-031/A1:2008

Table 12: Certifications and compliances (cont.)

Characteristics	Description	
Measurement Category Descriptions	<i>Category</i>	<i>Examples of Products in this Category</i>
	CAT III	Distribution-level mains, fixed installation
	CAT II	Local-level mains, appliances, portable equipment
	CAT I	Circuits not directly connected to mains.
Pollution Degree 2	Do not operate in environments where cond- uctive pollutants may be present (as defined in IEC 61010-1). Rated for indoor use only.	



Equipment Recycling. This product complies with the European Union's requirements according to Directive 2002/96/EC on waste electrical and electronic equipment (WEEE). For more information about recycling options, check the Support/Service section of the Tektronix Web site (www.tektronix.com).

Safety Summary

Review the following safety precautions to avoid injury and prevent damage to this product or any products connected to it. To avoid potential hazards, use this product only as specified. Using the probe or accessories in a manner not specified could result in a shock or fire hazard.

To Avoid Fire or Personal Injury

Ground-Referenced Oscilloscope Use. Do not float the reference lead of this probe when using with ground referenced oscilloscopes (for example, TDS2000C series oscilloscopes). The reference lead must be connected to earth potential (0 V).

TPS2000 and TPS2000B Series Oscilloscope Use. Do not float the reference lead of this probe above the rated float voltage (30 V_{RMS}).

Connect and Disconnect Properly. Connect the probe output to the measurement instrument before connecting the probe to the circuit under test. Disconnect the probe input and the probe reference lead from the circuit under test before disconnecting the probe from the measurement instrument.

Avoid Electric Shock. Do not connect or disconnect probes or test leads while they are connected to a voltage source.

Observe All Terminal Ratings. To avoid fire or shock hazard, observe all ratings and markings on the product. Consult the product manual for further ratings information before making connections to the product.

Avoid Electric Shock. When using probe accessories, never exceed the lowest rating of the probe or its accessory, whichever is less, including the measurement category and voltage rating.

Inspect the Probe and Accessories. Before each use, inspect the probe and accessories for damage (cuts, tears, defects in the probe body, accessories, cable jacket, etc.). Do not use if damaged.

Do Not Operate in Wet/Damp Conditions.

Do Not Operate in an Explosive Atmosphere.

Keep Product Surfaces Clean and Dry.

**Safety Terms and Symbols
Terms in This Manual.**

These terms may appear in this manual:



WARNING. *Warning statements identify conditions or practices that could result in injury or loss of life.*



CAUTION. *Caution statements identify conditions or practices that could result in damage to this product or other property.*

Symbols on the Product. These symbols may appear on the product:



Caution
Refer to Manual



Earth Terminal

Appendix C: Accessories

All accessories (standard and optional) are available by contacting your local Tektronix field office.

Table 13: Standard Accessories

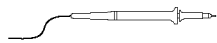

TPP0101 and TPP0201 Series 10X Passive Probes. The TPP0101 and TPP0201 probes are high impedance, passive probes with 10X attenuation. They are designed for use with TPS2000B and TDS2000C Series oscilloscopes.

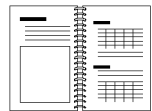

TPS2000B Series Oscilloscope User Manual. A single user manual is included. Refer to the Optional Accessories for a complete list of available language manuals.

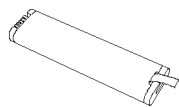

TPSBAT Battery Pack. Battery packs make the oscilloscope portable. The length of time you can operate the oscilloscope from battery packs depend on the oscilloscope model. (See page 6, *Battery Packs*.)

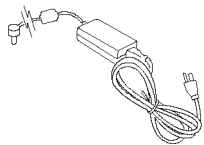

Oscilloscope AC Adapter with Cord. Refer to Optional Accessories for a list of available international power cords. AC adapters are not rated for temperatures below 0 °C (+32 °F) or intended for outdoor use. (See Table 14.)

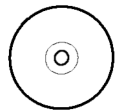

PC Communications CD-ROM The PC Communications software provides easy transfer of data from the oscilloscope to a PC.

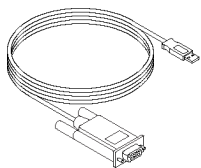

RS-232/USB Cable. This cable lets you connect the TPS2000B oscilloscope to a USB port on a PC.

Table 14: Optional Accessories

	<p>TPS2PWR1 Application. The TPS2PWR1 Power Analysis Application extends power measurement capabilities.</p>
	<p>WST-RO CD-ROM. The WST-RO WaveStar Software for Oscilloscopes allows you to control the oscilloscope from a PC.</p>
	<p>TPSCHG Battery Charger. The TPSCHG external battery charger accommodates two battery packs. Refer to International Power Cords for a list of available power cords. Battery chargers are not rated for temperatures below 0 °C (+32 °F) or intended for outdoor use.</p>
	<p>P5120 Passive Hi-Voltage Probe.* The probe is 200 MHz, 20X, 1000 V_{RMS} and 3 meters (3.2 yards) long.</p>
	<p>A621 AC Only Current Probe.* The probe is 5 Hz to 50 kHz with 1/10/100 mV/A settings, and 2000 APK.</p>
	<p>A622 AC/DC Current Probe.* The probe is DC to 100 kHz with 10/100 mV/A settings, and 100 APK.</p>
	<p>TCP303 AC/DC Current Probe (requires TCPA300 Amplifier)* The probe is DC to 15 MHz with 5/50 mV/A settings, 150 A_{RMS}, and 500 APK.</p> <p>TCP305 AC/DC Current Probe (requires TCPA300 Amplifier)* The probe is DC to 50 MHz with 5/10 mV/A settings, 50 A DC, and 500 APK.</p> <p>TCP312 AC/DC Current Probe (requires TCPA300 Amplifier)* The probe is DC to 100 MHz with 1/10 A/V settings, 30 A DC, and 500 APK.</p>

Table 14: Optional Accessories (cont.)



Soft Case. The soft case (AC2100) protects the oscilloscope from damage and provides space for probes, batteries, battery charger, power cord, and manuals.

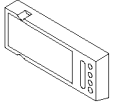
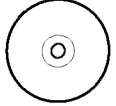
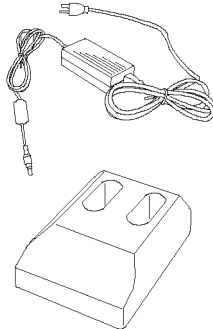
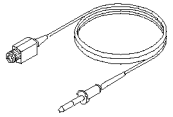
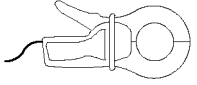
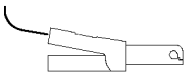
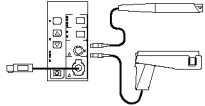
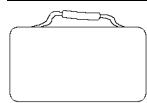
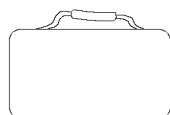

Transit Case. The transit case (HCTEK4321) provides shock, vibration, impact and moisture protection for the oscilloscope when you transport it from one place to another. The required soft case fits inside the transit case.

* Refer to the www.tektronix.com web site for a list of other compatible high voltage and current probes.

Table 15: Optional Power Cords and Documentation

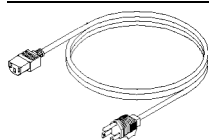

International Power Cords. In addition to the power cord shipped with your oscilloscope, you can obtain the following cords:

- Option A0, North American 120 V, 60 Hz, 161-0066-00
- Option A1, European 230 V, 50 Hz, 161-0066-09
- Option A2, United Kingdom 230 V, 50 Hz, 161-0066-10
- Option A3, Australian 240 V, 50 Hz, 161-0066-11
- Option A5, Switzerland 230 V, 50 Hz, 161-0154-00
- Option A10, China 220 V, 50 Hz, 161-0304-00
- Option A11, India 230 V, 50 Hz, 161-0400-00



TPS2000B Series Digital Storage Oscilloscope User Manuals. The user manual is available in these languages:

- English, 071-2733-XX
- French, 071-2734-XX
- Italian, 071-2735-XX
- German, 071-2736-XX
- Spanish, 071-2737-XX
- Japanese, 071-2738-XX
- Portuguese, 071-2739-XX
- Simplified Chinese, 071-2740-XX
- Traditional Chinese, 071-2741-XX
- Korean, 071-2742-XX
- Russian, 071-2743-XX

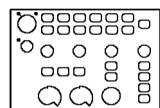

2-channel overlay

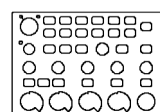

4-channel overlay



TPP0100/TPP0101 and TPP0200/TPP0201 Series, 100 and 200 MHz 10X Passive Probes Instructions. The TPP0100/0101 and TPP0200/0201 probe manual (071-2786-XX, English) provides information on the probe and probe accessories.

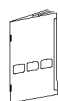

P5120 20X Passive Hi-Voltage Probe Instructions. The P5120 probe manual (071-1463-XX, English) provides information on the probe and probe accessories.

Table 15: Optional Power Cords and Documentation (cont.)

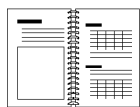

TPS2PWR1 Power Analysis Application User Manuals. The user manual is available in these languages:

- English, 071-1452-XX
- French, 071-1453-XX
- Italian, 071-1454-XX
- German, 071-1455-XX
- Spanish, 071-1456-XX
- Japanese, 071-1457-XX
- Portuguese, 071-1458-XX
- Simplified Chinese, 071-1459-XX
- Traditional Chinese, 071-1460-XX
- Korean, 071-1461-XX
- Russian, 071-1462-XX



TDS200, TDS1000/2000, TDS1000B/2000B, TDS2000C, and TPS2000/2000B Series Digital Oscilloscopes Programmer Manual. The programmer manual (077-0444-XX English) provides command and syntax information.

TPS2000B Series Digital Storage Oscilloscope Service Manual. The service manual (077-0446-XX, English) provides module-level repair information. It is available from the www.tektronix.com/manuals Web site.

Appendix D: Cleaning

General Care

Do not store or leave the oscilloscope where the LCD display will be exposed to direct sunlight for long periods of time.



CAUTION. *To avoid damage to the oscilloscope or probes, do not expose them to sprays, liquids, or solvents.*

Cleaning

Inspect the oscilloscope and probes as often as operating conditions require. To clean the exterior surface, perform the following steps:

1. Remove loose dust on the outside of the oscilloscope and probes with a lint-free cloth. Use care to avoid scratching the clear glass display filter.
2. Use a soft cloth dampened with water to clean the oscilloscope. Use an aqueous solution of 75% isopropyl alcohol for more efficient cleaning.



CAUTION. *To avoid damage to the surface of the oscilloscope or probes, do not use any abrasive or chemical cleaning agents.*

Appendix E: Default Setup

This appendix describes the options, buttons and controls that change settings when you push the **Default Setup** button. The last page of this appendix lists settings that do not change.

NOTE. When you push the **Default Setup** button, the oscilloscope displays the channel 1 waveform and removes all other waveforms.

Menu or system	Option, button or knob	Default setting
Acquire	(three mode options)	Sample
	Averages	16
	Run/Stop	Run
AutoRange	Autorange	Off
	Mode	Vertical and Horizontal
Cursor	Type	Off
	Source	CH1
	Horizontal (amplitude)	± 3.2 divs
	Vertical (time)	± 4 divs
Display	Type	Vectors
	Persist	Off
	Format	YT
Horizontal	Window	Main
	Trig Knob	Level
	POSITION	0.00 s
	Horizontal Scale	500 μ s
	Window Zone	50 μ s
Math	Operation	-
	Sources	CH1 - CH2
	Position	0 divs
	Vertical Scale	2 V
	FFT operation:	
	Source	CH1
	Window	Hanning
FFT Zoom	X1	
Measure (all)	Source	CH1
	Type	None
Trigger (common)	Type	Edge
	Source	CH1

Menu or system	Option, button or knob	Default setting
Trigger (Edge)	Slope	Rising
	Mode	Auto
	Coupling	DC
	Level	0.00 V
Trigger (Video)	Polarity	Normal
	Sync	All Lines
	Standard	NTSC
Trigger (Pulse)	When	=
	Set Pulse Width	1.00 ms
	Polarity	Positive
	Mode	Auto
	Coupling	DC
Vertical system, all channels	Coupling	DC
	BW Limit	Off
	Volts/Div	Coarse
	Probe	Voltage
	Voltage Probe Attenuation	10X
	Current Probe Scale	10 A/V
	Invert	Off
	Position	0.00 divs (0.00 V)
	Scale	1.00 V

The **Default Setup** button does not reset the following settings:

- Language option
- Saved setups
- Saved reference waveforms
- Front panel backlight
- Display brightness
- Calibration data
- Printer setup
- RS-232 setup
- Date and time
- Current folder on the CompactFlash card

Appendix F: Font Licenses

The following license agreements cover Asian fonts used in the TPS2000B series oscilloscopes.

Copyright © 1988 The Institute of Software, Academia Sinica.

Correspondence Address: P.O.Box 8718, Beijing, China 100080.

Permission to use, copy, modify, and distribute this software and its documentation for any purpose and without fee is hereby granted, provided that the above copyright notices appear in all copies and that both those copyright notices and this permission notice appear in supporting documentation, and that the name of "the Institute of Software, Academia Sinica" not be used in advertising or publicity pertaining to distribution of the software without specific, written prior permission. The Institute of Software, Academia Sinica, makes no representations about the suitability of this software for any purpose. It is provided "as is" without express or implied warranty.

THE INSTITUTE OF SOFTWARE, ACADEMIA SINICA, DISCLAIMS ALL WARRANTIES WITH REGARD TO THIS SOFTWARE, INCLUDING ALL IMPLIED WARRANTIES OF MERCHANTABILITY AND FITNESS, IN NO EVENT SHALL THE INSTITUTE OF SOFTWARE, ACADEMIA SINICA, BE LIABLE FOR ANY SPECIAL, INDIRECT OR CONSEQUENTIAL DAMAGES OR ANY DAMAGES WHATSOEVER RESULTING FROM LOSS OF USE, DATA OR PROFITS, WHETHER IN AN ACTION OF CONTRACT, NEGLIGENCE OR OTHER TORTIOUS ACTION, ARISING OUT OF OR IN CONNECTION WITH THE USE OR PERFORMANCE OF THIS SOFTWARE.

© Copyright 1986-2000, Hwan Design Inc.

You are hereby granted permission under all Hwan Design propriety rights to use, copy, modify, sublicense, sell, and redistribute the 4 Baekmuk truetype outline fonts for any purpose and without restriction; provided, that this notice is left intact on all copies of such fonts and that Hwan Design Int.'s trademark is acknowledged as shown below on all copies of the 4 Baekmuk truetype fonts.

BAEKMUK BATANG is a registered trademark of Hwan Design Inc.
BAEKMUK GULIM is a registered trademark of Hwan Design Inc. BAEKMUK DOTUM is a registered trademark of Hwan Design Inc. BAEKMUK HEADLINE is a registered trademark of Hwan Design Inc.

© Copyright 2000-2001 /efont/ The Electronic Font Open Laboratory. All rights reserved.

Redistribution and use in source and binary forms, with or without modification, are permitted provided that the following conditions are met:

- Redistribution of source code must retain the above copyright notice, this list of conditions and the following disclaimer.
- Redistributions in binary form must reproduce the above copyright notice, this list of conditions and the following disclaimer in the documentation and/or other materials provided with the distribution.
- Neither the name of the team nor the names of its contributors may be used to endorse or promote products derived from this font without specific prior written permission.

THIS FONT IS PROVIDED BY THE TEAM AND CONTRIBUTORS "AS IS" AND ANY EXPRESS OR IMPLIED WARRANTIES, INCLUDING, BUT NOT LIMITED TO, THE IMPLIED WARRANTIES OF MERCHANTABILITY AND FITNESS FOR A PARTICULAR PURPOSE ARE DISCLAIMED. IN NO EVENT SHALL THE TEAM OR CONTRIBUTORS BE LIABLE FOR ANY DIRECT, INDIRECT, INCIDENTAL, SPECIAL, EXEMPLARY, OR CONSEQUENTIAL DAMAGES (INCLUDING, BUT NOT LIMITED TO, PROCUREMENT OF SUBSTITUTE GOODS OR SERVICES; LOSS OF USE, DATA, OR PROFITS; OR BUSINESS INTERRUPTION) HOWEVER CAUSED AND ON ANY THEORY OF LIABILITY, WHETHER IN CONTRACT, STRICT LIABILITY, OR TORT (INCLUDING NEGLIGENCE OR OTHERWISE) ARISING IN ANY WAY OUT OF THE USE OF THIS FONT, EVEN IF ADVISED OF THE POSSIBILITY OF SUCH DAMAGE.

Appendix G: TPS2000B Compatible Probe Maximum Voltages

Passive Probes

	P2220	10X	P5120
Attenuation Gain Setting	1X	10X	20X
Maximum Input Voltage ¹ between Tip (Signal) and the Reference Lead Maximum Input	150 V _{RMS} CAT II	300 V _{RMS} CAT II	1,000 V _{RMS} CAT II
Maximum Input Voltage ¹ between Tip (Signal) and Earth Ground	150 V _{RMS} CAT II	300 V _{RMS} CAT II	1,000 V _{RMS} CAT II
Maximum Voltage between the Reference Lead and Earth Ground when used with TPS2000B Series	30 V _{RMS} (42.4 V peak)	30 V _{RMS} (42.4 V peak)	600 V _{RMS} CAT II

¹ ¹ As defined in IEC 61010-1: 2001.

Differential Probes

	P5205 with 1103	
Attenuation Gain Setting	50X	500X
Maximum Linear Differential Mode Input Voltage ¹ (between Probe Tips)	130 V (DC + PK _{AC}), 100 V _{RMS}	1,300 V (DC + PK _{AC}), 1000 V _{RMS}
Maximum Linear Common Mode Input Voltage ¹ (between either + or - Probe Tip and Earth Ground)	1,000 V _{RMS} CAT II 600 V _{RMS} CAT III	1,000 V _{RMS} CAT II 600 V _{RMS} CAT III

¹ The float voltage must be subtracted from the tip to earth ground voltage. For example, if the reference lead is floated to 30 V_{RMS}, the tip voltage to the reference lead is limited to 270 V_{RMS}.

Differential Probes

	P5210 with 1103	
Attenuation Gain Setting	100X	1000X
Maximum Linear Differential Mode Input Voltage ¹ (between Probe Tips)	560 V (DC + PK AC) 440 V _{RMS}	5,600 V (DC + PK AC) 4,400 V _{RMS}
Maximum Linear Common Mode Input Voltage ¹ (between either + or - Probe Tip and Earth Ground)	2,200 V _{RMS} CAT I 1,000 V _{RMS} CAT III	2,200 V _{RMS} CAT I 1,000 V _{RMS} CAT III

¹ The float voltage must be subtracted from the tip to earth ground voltage. For example, if the reference lead is floated to 30 V_{RMS}, the tip voltage to the reference lead is limited to 270 V_{RMS}.

Differential Preamplifier

ADA400A with 1103		
Attenuation Gain Setting	0.1X	1X
Maximum Linear Differential Mode Input Voltage ¹ (between Probe Tips)	±80 V (DC + PK AC)	±10 V (DC + PK AC)
Maximum Linear Common Mode Input Voltage ¹ (between either + or - Probe Tip and Earth Ground)	±40 V (DC + PK AC)	±40 V (DC + PK AC)
ADA400A with 1103		
Attenuation Gain Setting	10X	100X
Maximum Linear Differential Mode Input Voltage ¹ (between Probe Tips)	±1 V (DC + PK AC)	±100 mV (DC + PK AC)
Maximum Linear Common Mode Input Voltage ¹ (between either + or - Probe Tip and Earth Ground)	±10 V (DC + PK AC)	±10 V (DC + PK AC)

¹ The float voltage must be subtracted from the tip to earth ground voltage. For example, if the reference lead is floated to 30 V_{RMS}, the tip voltage to the reference lead is limited to 270 V_{RMS}.

Index

A

- Abbreviating
 - commands, 78
- Abort printing, 72
- AC adapters
 - battery charger, 88, 140
 - oscilloscope, 5, 139
- AC coupling
 - trigger, 113
 - vertical, 120
- Accessories, 139
- Acquire button, 25, 93
- Acquire menu, 93
- Acquire signals
 - basic concepts, 30
- Acquisition
 - live display, 95
 - single-shot example, 51
 - stopping, 95
- Acquisition modes, 30, 93
 - Average, 30, 94
 - indicators, 17
 - Peak Detect, 30, 94
 - Sample, 30, 93
- Add waveforms
 - Math menu, 105
- Aliasing
 - check for, 32
 - FFT, 66
 - time domain, 31
- Amplitude cursors, 35, 100
- Amplitude measurements
 - using cursors, 46
- Application
 - power analysis, 140
- Application button, 25
- Application examples
 - analyzing a differential communication signal, 44
 - analyzing signal detail, 50
 - automatic measurements, 38
 - autoranging to examine test points, 43
 - autoset, using, 38
 - averaging, using, 51
 - calculating amplifier gain, 42
 - capturing a single-shot signal, 51
 - cursors, using, 46
 - isolated channels to analyze a differential signal, 44
 - looking at a noisy signal, 50
 - measuring propagation delay, 53
 - measuring pulse width, 47
 - measuring ring amplitude, 46
 - measuring ring frequency, 46
 - measuring rise time, 48
 - measuring two signals, 41
 - optimizing the acquisition, 52
 - peak detect, using, 50
 - power analysis using Math, 45
 - reducing noise, 51
 - taking automatic measurements, 39
 - taking cursor measurements, 46
 - triggering on a specific pulse width, 54
 - triggering on a video signal, 55
 - triggering on video fields, 56
 - using Autorange to examine test points, 43
 - using persistence, 60
 - using the window function, 58
 - using XY mode, 60
 - viewing a Math instantaneous power waveform, 45
 - viewing impedance changes in a network, 59
- Application key, 26
- ASCII interface, 78
- Attenuation
 - voltage probe, 11, 12, 121
- Auto trigger mode, 113
- Automatic measurements, 107
 - basic concepts, 35
- AutoRange button, 24
- Autorange functions, 27
 - overview, 95
 - turning off, 96
- Autorange menu, 95
- AutoSet
 - button, 25
- Autoset functions, 27
 - DC level, 97
 - FFT, 99
 - noise, 98
 - overview, 97
 - pulse signal, 99
 - sine waves, 98
 - square wave, 99
 - Undo, 99
 - video signal, 99
 - when to use, 98
- Autoset menu, 97
- Average
 - acquisition mode, 93
 - Mean measurement, 107
- Average acquisition mode, 30, 94
- Average mode
 - icon, 17

B

- Bandwidth limit
 - trigger, 113
 - vertical, 121
- Bandwidth limited readout, 17

- Battery packs
 - calibration, 90
 - check, 87
 - care, 86
 - charge, 88
 - check level, 87
 - external, 88
 - internal, 88
 - temperature, 86, 88
 - time, 88
 - charger, 88
 - charging conditions, 86
 - charging internally
 - LED indicator, 26
 - continuous charge, 86
 - external charger, 140
 - installation, 6
 - internal charger, 139
 - Li-Ion, 85
 - manage power, 85
 - operating time, 87
 - removal, 7
 - replacement, 92
 - self-discharge, 86
 - service, 86
 - storage, 86, 91
 - temperature
 - recommended
 - operating, 86
 - TPSBAT, 6, 139
 - Bezel buttons, xv
 - Binary data
 - RS-232 transfer, 77
 - BMP file format, 72
 - BNC connectors, 5
 - Break signals
 - RS-232 protocol, 77
 - Button names, xv
 - BW limit for vertical, 121
- C**
- Cable, RS-232/USB, 79, 139
 - Calendar, 118
 - Calibrate
 - battery packs, 90
 - check charge status, 87
 - external charger, 90
 - inside oscilloscope, 90
 - length of time, 90
 - Calibration, 118
 - automatic routine, 13
 - Centronics port, 71
 - CF card, 81
 - Channel
 - coupling, 120
 - menu, 120
 - scale, 17
 - Channel 1, 2, 3, or 4
 - connectors, 26
 - Channels 1, 2, 3, or 4
 - Menu buttons, 21
 - Charge
 - battery packs, 88
 - charge time, 88
 - check level, 87
 - temperature, 88
 - Charger
 - battery external, 140
 - Cleaning, 143
 - Clock
 - set date and time, 118
 - Coarse resolution, 121
 - Command
 - abbreviating, 78
 - Communications ports, 71
 - CompactFlash card
 - file management, 82
 - File utilities, 119
 - formatting, 81
 - installation, 81
 - Print button, 83
 - saving files
 - all, 83
 - images, 84
 - setups, 83
 - waveforms, 83
 - slot and LED locations, 26
 - storage capacity, 82
 - Compensation
 - Probe Comp connector, 25
 - voltage probe check wizard, 11
 - voltage probe manual, 11
 - Connectors
 - BNC, 5
 - Centronics port, 71
 - Channels 1, 2, 3 and 4, 25
 - DC input, 5
 - Ext Trig, 25
 - probe, 3
 - Probe Comp, 25
 - RS-232 port, 71
 - Context-sensitive help topics, xiv
 - Continuously charge battery packs, 86
 - Conventions used in this manual, xv
 - Coupling
 - trigger, 29, 114
 - vertical, 120, 121
 - CSV file format, 110
 - Current folder, 82, 119
 - Current probes
 - scale setting, 13, 121
 - Cursor button, 25, 100
 - Cursor menu, 100
 - Cursors
 - adjusting, 100
 - Amplitude, 35, 100
 - basic concepts, 35
 - Frequency for FFT, 100
 - Magnitude for FFT, 100
 - measurement examples, 46
 - measuring an FFT spectrum, 69
 - Time, 35, 100
 - using, 100
 - Cycle RMS measurements, 107
- D**
- Data transfer
 - RS-232 interface, 73
 - Date, 118
 - Date and time readout, 18

- DC coupling
 - trigger, 113
 - vertical, 120
 - Default setup
 - Edge trigger, 145, 146
 - Pulse trigger, 146
 - recalling, 112
 - Video trigger, 146
 - Default Setup button
 - option and control settings, 145
 - retained option settings, 146
 - Delayed sweep, 104
 - Deleting
 - files or folders, 119
 - reference waveforms, 111
 - Deleting files or folders, 116
 - Delta readouts in Cursor menu, 101
 - Description
 - general, 1
 - Diagonal lines in waveform
 - peak detect, 94
 - Directories
 - deleting, 116, 119
 - Display
 - intensity, 101
 - menu, 101
 - persistence, 101
 - readouts, 16
 - style (Invert), 121
 - style of waveforms, 102
 - type: vectors or dots, 101
 - XY format, 102
 - YT format, 102
 - Display button, 25, 101
 - Display Refs menu, 111
 - Displaying waveforms, 120
 - reference, 111
 - Do Self Cal option, 13
 - Dots display type, 101
 - Dual time base, 22, 104
- E**
- Edge trigger, 112
 - EPSIMAGE file format, 72
 - Error Log, 118
 - Ext Trig connector, 26
 - probe compensation, 11
- F**
- Factory calibration, 119
 - Factory setup, 145
 - recalling, 112
 - Fall time measurements, 107
 - Features
 - overview, 1
 - FFT aliasing, 66
 - remedies, 68
 - FFT spectrum
 - applications, 61
 - displaying, 64
 - magnify, 68
 - measuring magnitude and frequency with cursors, 69
 - Nyquist frequency, 63
 - process, 61
 - readouts, 64
 - Window, 65
 - FFT Window
 - Flattop, 66
 - Hanning, 66
 - Rectangular, 66
 - FFT zoom
 - horizontal, 64
 - vertical, 63
 - Field video trigger, 115
 - File formats for images, 72
 - File utilities, 119
 - CompactFlash card contents, 119
 - creating files or folders, 119
 - deleting files or folders, 116, 119
 - navigating the directory structure, 119
 - renaming files or folders, 120
 - selecting files or folders, 119
 - Fine resolution, 121
 - Firmware updates, 120
 - Flattop window, 66
 - Floating measurements, 3
 - Folders
 - creating, 119
 - deleting, 116, 119
 - renaming, 120
 - Force Trig button, 23
 - Format
 - CompactFlash card, 81
 - display, 102
 - image file, 72
 - printer, 72
 - Frequency
 - trigger readout, 18, 113
 - Frequency cursors, 35
 - FFT spectrum, 69
 - Frequency measurements, 107
 - FFT cursors, 69
 - using cursors, 46
 - Front panel illumination, 118
 - Functional check, 9
- G**
- Graticule, 35, 101
 - Ground coupling, 120
- H**
- Hanger, 7
 - attaching, 7
 - Hanning window, 66
 - Help scroll LED, xiv
 - Help system, xiv
 - Helpful messages, 18
 - High voltage
 - warning, 4
 - Holdoff, 105, 117
 - Horiz Menu button, 22
 - Horizontal
 - aliasing, time domain, 31
 - menu, 104
 - position, 31
 - position marker, 17
 - scale, 31
 - Scan mode, 95, 105
 - status, 118
 - Hyperlinks in help topics, xiv

- I/O errors
 - RS-232 report, 77
- Icons
 - acquisition modes,
 - Average, 17
 - acquisition modes, Peak
 - Detect, 17
 - acquisition modes,
 - Sample, 17
 - Bandwidth limited
 - readout, 17
 - channel scale, 17
 - date and time readout, 18
 - horizontal position
 - marker, 17
 - inverted waveform
 - readout, 17
 - Math marker, 46
 - Reference marker, 17
 - reference waveforms
 - readout, 18
 - time base readout, 17
 - trigger position marker, 17
 - trigger status, Acq.
 - Complete, 17
 - trigger status, Armed, 17
 - trigger status, Auto mode, 17
 - trigger status, Ready, 17
 - trigger status, Scan mode, 17
 - trigger status, Stop, 17
 - trigger status, Trig'd, 17
 - trigger type, Edge, 18
 - trigger type, Pulse Width, 18
 - trigger type, Video, 18
 - trigger, frequency readout, 18
 - trigger, level marker, 17
 - trigger, level readout, 18
 - trigger, position readout, 17
 - trigger, source, 17
 - vertical scale, 17
 - window time base readout, 17
- Illumination
 - color models, 118
- Image file formats, 72
- Index for help topics, xiv
- Indicators, 17
- Infrequent events
 - infinite persistence, 103
- Intensity, 101
- Interfaces for PCs and printers, 71
- Interpolation, 94
- Inverted waveform
 - readout, 17
- Isolated channels
 - description, 3
- L**
- Languages, 118
- Level, 23, 29
- Level control, 23
- Li-Ion battery packs, 85
- Line video trigger, 115
- Lissajous pattern
 - XY format, 103
- M**
- M indicator for Main time
 - base, 104
- M marker for Math
 - waveforms, 46
- Magnify horizontal
 - window, 104
- Magnitude cursors, 35
 - FFT spectrum, 69
- Main time base, 22, 104
- Manage
 - battery pack resources, 85
- Manuals ordering, 141
- Math
 - FFT, 61, 64
 - functions, 105
 - menu, 105
- Math Menu button, 21
- math waveform
 - allowed units, 106
- Maximum measurements, 107
- Measure button, 24
- Measure menu, 107
- Measurements
 - automatic, 35, 107
 - basic concepts, 34
 - cursor, 35, 46
 - cycle RMS, 107
 - fall time, 107
 - FFT spectrum, 69
 - floating, 3
 - frequency, 107
 - graticule, 35
 - maximum, 107
 - mean, 107
 - minimum, 107
 - negative width, 107
 - peak-to-peak, 107
 - period, 107
 - positive width, 107
 - rise time, 107
 - types, 107
- Memory
 - removable mass storage, 81
 - screen images, 108
 - setups, 108
 - waveforms, 108
- Menu system
 - using, 19
- Menus
 - Acquire, 93
 - Autorange, 95
 - Autoset, 97
 - Cursor, 100
 - Display, 101
 - Help, 104
 - Horizontal, 104
 - Math, 105
 - Math FFT, 64
 - Measure, 107
 - Print, 107
 - Save/Recall, 108
 - Trigger, 112
 - Utility, 118
 - Vertical, 120
- Messages, 18, 19
- Minimum measurements, 107
- Multiply waveforms
 - Math menu, 105
- Multipurpose knob, 24

N

- Navigation
 - file system, 119
- Negative width
 - measurements, 107
- Noise reduction
 - Average mode, 93
 - Math subtraction, 106
 - trigger coupling, 113
 - vertical bandwidth limit, 121
- Nonvolatile memory
 - reference waveform files, 108
 - setup files, 108
- Normal operation
 - recall default setup, 28
- Normal trigger mode, 113
- NTSC video standard, 115
- Nyquist
 - frequency, 63

O

- OpenChoice software, 139
 - RS-232 interface, 75
- Operating temperature
 - battery packs, 86
- Operating time
 - battery packs, 6
 - remaining, 90
- Option buttons, xv
- Option types
 - Action, 20
 - Circular List, 19
 - Page Selection, 19
 - Radio, 20
- Oscilloscope
 - front panels, 15
 - power through AC adapter, 5
 - set date and time, 118
 - specifications, 123
 - understanding functions, 27

P

- PAL video standard, 115
- Panning
 - horizontal, 31
 - vertical, 31

PC

- communications
 - software, 139
- PCX file format, 72
- Peak Detect acquisition mode, 30, 94
- Peak Detect mode, 93
 - icon, 17
- Peak-to-Peak measurements, 107
- Peak-to-peak noise, 103
- Period measurements, 107
- Persistence, 101, 103
- Phase differences, 103
- po-
 - triggering on video lines, 57
- Polarity
 - Pulse Width trigger, 115
 - Video trigger sync, 115
- Ports
 - communications, 71
- Position
 - horizontal, 31, 104
 - trigger, 114
 - vertical, 120
- Position control
 - horizontal, 22
 - vertical, 21
- Positive width
 - measurements, 107
- Power
 - manage battery packs, 85
 - oscilloscope AC adapter, 5
 - specifications, 129
- Power analysis application
 - ordering, 140
- Power cords, 7
 - ordering, 141
- Power Cycle count, 118
- Pretrigger, 28
- Pretrigger view, 114
- Print button, 25, 107
- Print button option
 - saving to a CF card, 83
- Print Button option, 108
- Printer
 - RS-232 interface, 73
 - setup, 72

Printing

- abort, 72
- screen data, 73, 107
- testing the port, 73
- Probe Check button, 11
- Probe Check Wizard
 - voltage probes, 11
- Probe Comp connections, 26
- Probe manuals ordering
 - P5120 20X hi-voltage, 141
 - TPP0101 and TPP0201 10X
 - passive, 141
- Probe option
 - match current probe scale, 13
 - match voltage probe
 - attenuation, 12
- Probes
 - Attenuation switch, 12
 - compensation, 26
 - current and scale, 13
 - optional accessories, 140
 - reference lead
 - isolated channel
 - connections, 4
 - safety, 10
 - TPP0101 and
 - TPP0201 standard, 9
 - voltage and attenuation, 121
 - voltage probe check
 - wizard, 11
 - voltage probe manual
 - compensation, 11
 - voltage ratings, 4
- Programmer manual
 - ordering, 142
- Pulse signal
 - Autoset function, 99
- Pulse width measurements
 - using cursors, 47
- Pulse Width triggering, 115

R

- Readouts
 - FFT (Math), 64
 - general, 16

- Recall
 - factory setup (default), 28
 - setups, 28, 112
 - waveforms, 112
- Recall Setup menu, 110
- Recall Waveform menu, 111
- Rectangular window, 66
- Reference
 - lead for probe, 10
 - marker, 17
 - probe terminal, 10
 - terminal, 26
- Reference lead
 - isolated channel connections, 4
- Reference waveforms
 - readout, 18
 - removing, 111
 - saving and recalling, 112
- Remote control using
 - RS-232 interface, 73
- Removable memory storage, 81
- Removing waveforms, 120
- Renaming files or folders, 120
- Replace battery packs, 92
- Resolution
 - fine, 121
- Rise time measurements
 - automatic, 107
 - using cursors, 48
- RLE file format, 72
- Roll mode *See* Scan mode
- RS-232 port, 71
 - cable part numbers, 73
 - connecting a cable, 74
 - connector pinout, 77
 - setup, 73
- RS-232 protocol
 - Break signals, 77
 - I/O errors, 77
 - setup options, 74
 - testing, 75
 - troubleshooting, 76
- RS-232/USB cable, 79, 139
- Run/Stop button, 25, 94
 - steps taken by the oscilloscope when pushed, 28
- S**
- Safety Summary, iv
- Sample acquisition mode, 30, 93
- Sample mode
 - icon, 17
- Sample rate
 - maximum, 94
- Save
 - setups, 28
- Save All menu, 108
- Save Image menu, 109
- Save Setup menu, 109
- Save Waveform menu, 110
- Save/Recall button, 24
- Save/Recall menu, 108
- Saving
 - All files to a CF card, 83
 - image files to a CF card, 84
 - setups, 112
 - waveforms, 112
- Scale
 - current probe, 13, 121
 - horizontal, 31
 - vertical, 31
- Scale (1, 2, 3, 4) controls, 21
- Scale control
 - horizontal, 22, 105
- Scaling waveforms
 - basic concepts, 31
- Scan mode, 95, 105
- Scanning waveforms, 105
- Screen buttons, xv
- Screen data
 - saving to a file, 84
 - sending to a printer, 73
 - sending to an external device, 73
- SECAM video standard, 115
- Security lock, 8
- Self calibration, 13
- Service
 - battery packs, 86
 - error log as a reference, 118
- Service manual, 142
- Set date and time, 118
- Set to 50% button, 23
- Set to Zero button, 22
- Setups
 - basic concepts, 27
 - saving and recalling, 108
- Side-menu buttons, xv
- Sine waves
 - Autoset function, 98
- Single button, 94
 - steps taken by the oscilloscope when pushed, 28
- Single-shot signal
 - application example, 51
- Slope, 29
- Soft case ordering, 141
- Soft keys, xv
- Software
 - OpenChoice, 139
 - TPS2PWR1 power analysis, 140
 - WaveStar, 140
- Source
 - AC Line, 115
 - Ext, 114
 - Ext/10, 114
 - Ext/5, 114
 - trigger, 29, 113, 115
- Specifications
 - oscilloscope, 123
- Square wave
 - Autoset function, 99
- Status
 - miscellaneous, 118
 - system, 118
- Store battery packs, 91
- Subtract waveforms
 - Math menu, 105
- Sweep
 - delayed, 104
 - horizontal scale, 104
- Sync
 - video polarity, 115
 - video trigger line or field, 115
- Sync pulse, 115
- T**
- TIFF file format, 72

- Time base, 30
 - Main, 22, 104
 - readout, 17
 - Window, 22, 104
 - Time cursors, 35, 100
 - Time domain
 - waveform, 61
 - TPS2PWR1 application
 - ordering, 140
 - TPS2PWR1 manual
 - ordering, 142
 - TPSBAT battery pack
 - manage power, 85
 - ordering, 139
 - TPSCHG battery charger
 - ordering, 140
 - Transit case ordering, 141
 - Trickle charge
 - battery packs, 86
 - Trig Menu button, 23
 - Trig View button, 23
- Trigger
 - coupling, 29, 113, 114
 - definition, 28
 - edge, 113
 - force, 116
 - frequency readout, 18, 113, 116
 - holdoff, 23, 105, 117
 - level, 23, 29, 112
 - level marker, 17
 - level readout, 18
 - menu, 112
 - modes, 29
 - modes: Auto, 113
 - modes: Normal, 113
 - polarity, 115
 - position, 29
 - position marker, 17
 - position readout, 17
 - pretrigger information, 114
 - slope, 29, 113
 - source, 17, 29, 113, 115
 - status, 118
 - status indicators, 17
 - sync, 115
 - type indicator, 17
 - types, 29
 - video, 115
 - view, 23, 117
 - Trigger Level control, 23
- U**
 - Utility button, 25
 - Utility menus, 118
- V**
 - Vectors, 101
 - Vertical
 - menu, 120
 - position, 31
 - position knob, 21
 - scale, 31
 - status, 118
 - Video signal
 - Autoset function, 99
 - Video trigger, 115
 - application example, 55
 - Voltage ratings
 - understand for probes, 4
 - Volts/Div
 - Coarse, 121
 - Fine, 121
- W**
 - W indicator for Window time base, 104
 - Waveforms
 - acquire data, 30
 - compression, 105
 - digitized, 30
 - display style meaning, 102
 - expansion, 105
 - Math instantaneous power, 45
 - position, 31
 - remove from screen, 121
 - scale, 31
 - scanning, 95
 - take measurements, 34
 - time domain, 61
 - WaveStar software
 - ordering, 140
 - Window time base, 22, 104
 - readout, 17
 - Window Zone, 104, 105
 - Windows
 - FFT spectrum, 65
 - WST-RO WaveStar software
 - ordering, 140
- X**
 - XY
 - application example, 59
 - display format, 102, 103
- Y**
 - YT
 - display format, 102

Z

Zoom, 58

 FFT, 68

 Horiz menu, 104

 Window Zone, 104, 105