

# MODEL 4200-SCS Semiconductor Characterization System

The simple choice for complex characterization tasks



A GREATER MEASURE OF CONFIDENCE

**KEITHLEY**

## The Model 4200-SCS

### THE MOST COMPREHENSIVE SOLUTION FOR SEMICONDUCTOR DEVICE CHARACTERIZATION

- Materials and device research
- Device and process development
- Device modeling
- Reliability and lifetime testing
- Failure analysis

For CMOS semiconductor technology  
and more

- High power MOSFET, BJT, and III-V device characterization
- Nanotechnology and MEMs research
- Advanced NVM testing
- Organic electronics characterization
- Solar cell/photovoltaic device characterization

**KEITHLEY**  
SEMICONDUCTOR CHARACTERIZATION SYSTEM  
4200-SCS

ACTIVE  
INTERLOCK  
HARD DISK

POWER

DC I-V, C-V, pulse, and ultra-fast I-V testing in the same flexible environment

Everything you need to fully characterize a device, material, or process

Familiar Windows® Interface

Start testing right out of the box—no training needed

Fast, single-click test sequencing

No complex programming required

Configurable, scalable solution

Plug in new capabilities as your test needs change

Low noise, wide measurement range, high resolution

See more, faster

Cost-effective hardware and software upgrades available

Modular design protects your instrumentation investment





A COMPLETE,  
INTEGRATED  
SOLUTION

ALL FROM ONE VENDOR

Industry-standard Windows-based GUI minimizes set-up and integration time.

Integrated industrial controller and additional RAM ensure high test throughput, plus system robustness, stability, and security.

Store test setups and results right on the system with the high capacity fixed disk drive.

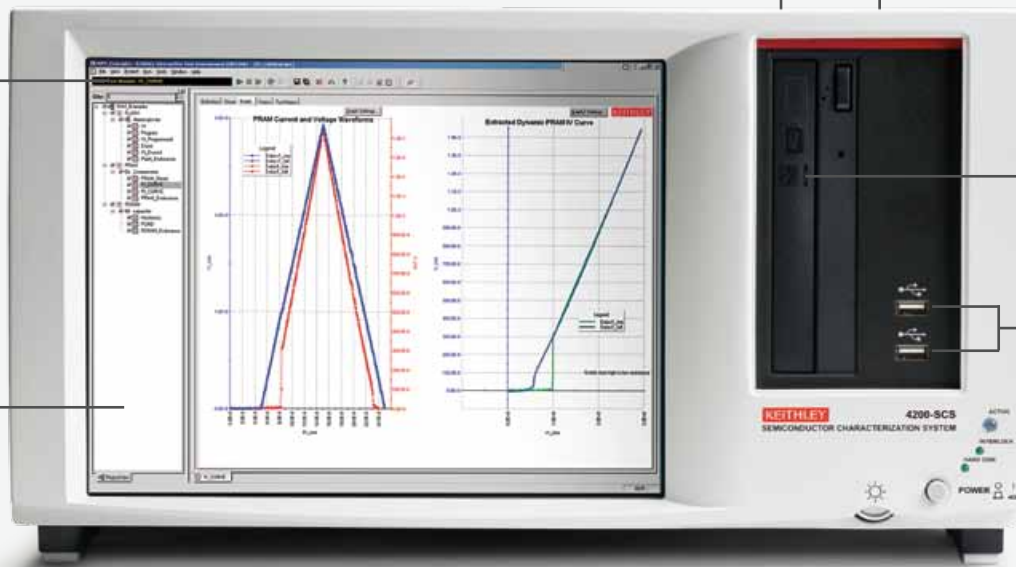

The integrated CD-RW drive allows high capacity backup and data transfer.

Communicate quickly with a wide range of PC accessories with the built-in USB interface.

### A Characterization Environment that Grows with Your Test Needs

- Flexible test environment and modular architecture allows characterizing the full range of materials, devices, and processes with a single set of instrumentation.
- Even infrequent users can begin testing productively right away, without programming assistance, for a lower cost of test and faster ROI.
- The flexible user interface makes it easy to change parameters on the fly and test devices interactively with just a mouse click.
- C-V tests are as easy to set up and run as DC I-V tests. An extensive set of sample programs, test libraries, and built-in parameter extraction examples are included, as well as support for high voltage C-V, very low frequency C-V, differential DC bias, and quasistatic C-V measurements.
- Make ultra-fast I-V measurements over a wide dynamic range to reduce the effects of device self-heating and trapped charge, study transient properties in non-volatile memory (NVM) devices, or avoid relaxation in device reliability tests like negative bias temperature instability (NBTI).
- Source high speed pulses to stress test a device using an AC signal during reliability cycling or in a multi-level waveform mode to program/erase memory devices.
- Export test settings, data, and plots to .xls, delimited text, .bmp, .jpg, or .tif file formats.
- More than 450 sample tests and projects for a variety of applications are included to simplify startup.

To learn more about C-V measurements, download a free copy of our application note, *"Making I-V and C-V Measurements on Solar/Photovoltaic Cells Using the Model 4200-SCS Semiconductor Characterization System"* from [www.keithley.com](http://www.keithley.com).

The Model 4210-CVU is an integrated instrument designed to plug directly into the chassis, so it can be controlled through the system's point-and-click interface, just like an SMU.

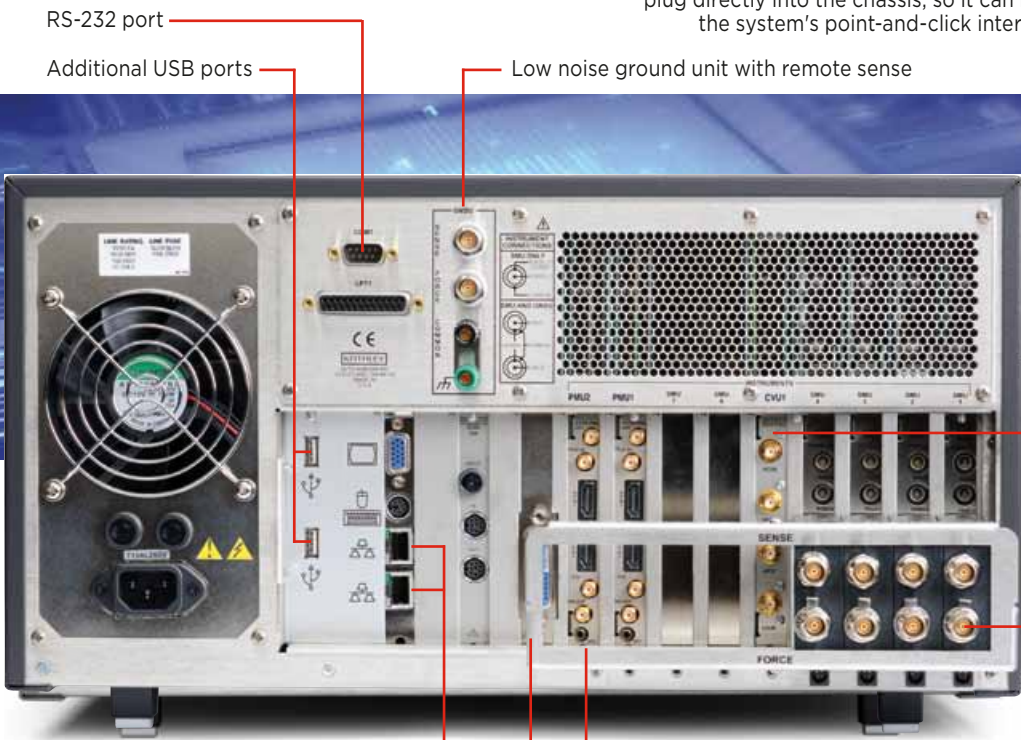

RS-232 port

Additional USB ports

Low noise ground unit with remote sense

Configurable with from 2 to 9 SMUs and optional sub-femtoamp Remote PreAmps. Adding high power SMUs won't restrict SMU capacity.

Standard 10/100 BASE-T network interface allows easy access to network files and printers.

Use the GPIB interface to control external instruments or to allow external control of the 4200-SCS.

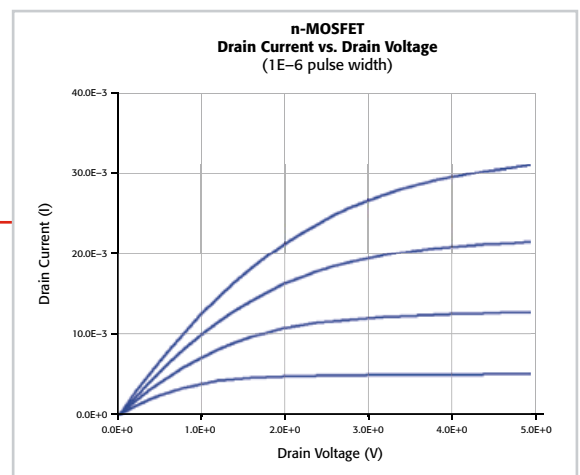

Add up to 6 dual-channel pulse generators to configure the system for a growing range of pulse applications, from I-V pulse testing to stress/measure reliability testing using parallel AC stress on multiple channels.

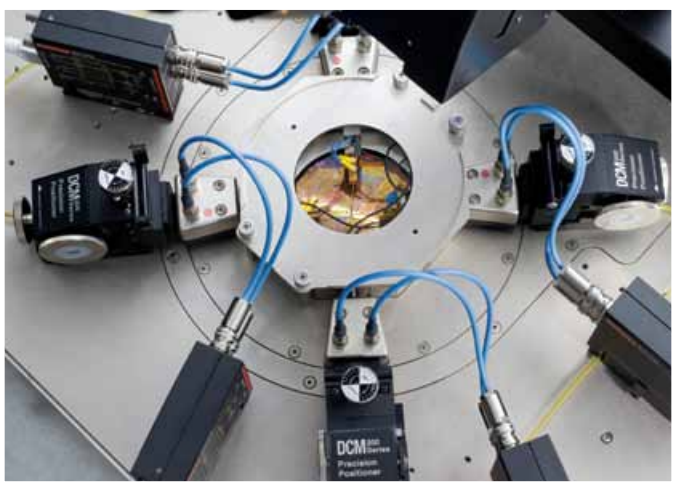

The optional Model 4225-RPM Remote Amplifier/Switch expands the ultra-fast I-V testing capabilities of the Model 4225-PMU, adding current sensitivity down to tens of picoamps. It also reduces cable capacitance effects and supports switching automatically between the Model 4225-PMU, the Model 4210-CVU, and other SMU modules installed in the chassis, allowing you to choose the most appropriate instrument for a particular measurement task without re-cabling. Our patented high performance Multi-Measurement Performance Cable kits make it easy to connect the Model 4200-SCS to a probe, simplifying switching between DC I-V, C-V, and ultra-fast I-V testing configurations and eliminating the need for recabling.

	Start (V)	Stop (V)	Time (s)	Trig (1/0)	SSR (1/0)
1	0	1	2.00E-08	1	1
2	1	1	1.00E-07	1	1
3	1	0	2.00E-08	0	0
4	0	0	1.00E-07	0	0

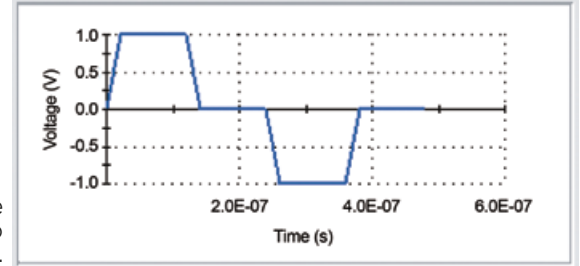

The economical two-channel Model 4220-PGU Pulse Generator Unit offers a voltage-sourcing-only alternative to the Model 4225-PMU, providing identical pulse outputs.

# ULTRA-FAST I-V

# AND C-V MEASUREMENTS AS EASY AS DC



With two channels of integrated sourcing and measurement, the Model 4225-PMU Ultra-Fast I-V module can be applied to a wide range of measurements, including device self-heating, NVM pulse sourcing and transient analysis, ultra-fast reliability testing such as NBTI, and more. Each channel combines high speed voltage sourcing with simultaneous current and voltage measurements on pulse widths from 60nsec to DC at a sample rate of up to 200 megasamples/second. When multiple modules are installed, they are internally synchronized to less than 3ns. If your application demands measuring extremely low current pulses, extend the Model 4225-PMU's measurement range with the optional Model 4225-RPM Remote Amplifier/Switch, which effectively adds three lower current ranges to any channel. This option also allows you to switch automatically between the precision DC SMUs, the Model 4210-CVU, or the Ultra-Fast I-V modules installed in the system's chassis.

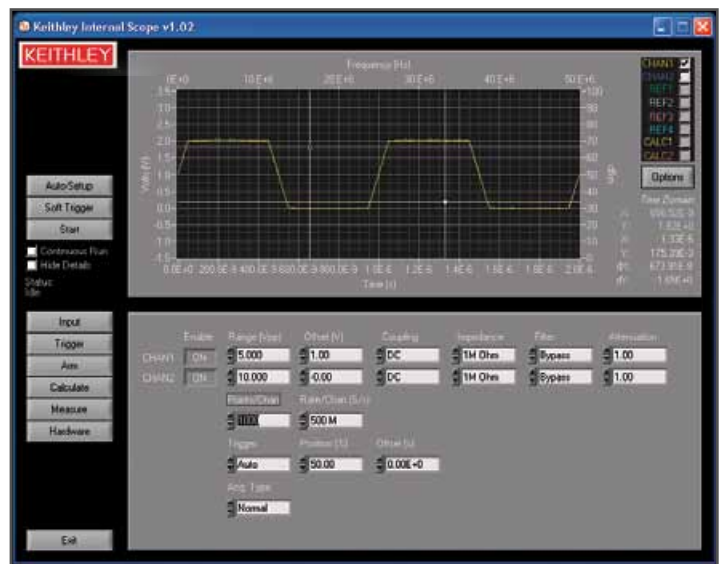
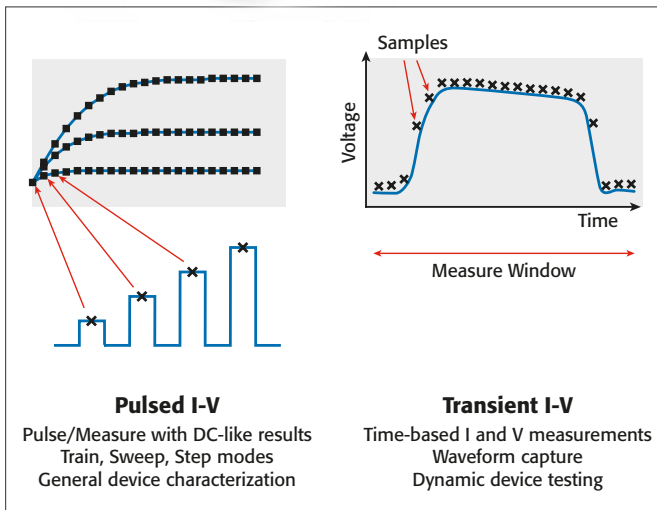

Don't need pulse measurements? Choose the Model 4220-PGU Dual-Channel Pulse Generator for dual-channel pulsing at up to 40V and pulse widths as short as 20ns. Linear, arbitrary waveform (ARB), and Segment ARB® (patent pending) sweeps are built in to the 4220-PGU and 4225-PMU.

Two dual-channel digital oscilloscope options are available:

- Model 4200-SCP2 (8-bit resolution, up to 2.5Gsamples/sec)
- Model 4200-SCP2HR (16-bit resolution, up to 400Msamples/sec).

Use them for automated measurement and data acquisition or for traditional oscilloscope tasks with the stand-alone GUI application provided. Both support measurements in both the time (frequency, rise/fall time) and voltage domains (amplitude, peak-peak, etc.).

Download our applications guide: [Ultra-Fast I-V Applications](#).



# FULL RANGE OF C-V MEASUREMENT CAPABILITY

The Model 4200-SCS can be configured to support quasistatic, high voltage, and very low frequency C-V measurements. An extensive set of sample programs, test libraries, and built-in parameter extraction examples are included to make C-V measurements as easy to perform as I-V measurements.

The optional Model 4210-CVU C-V Meter plugs directly into the chassis for measuring capacitances from femtofarads (fF) to microfarads ( $\mu\text{F}$ ) at frequencies from 1kHz to 10MHz. Quickly configure linear or custom C-V, C-f, and C-t sweeps with up to 4096 data points. A built-in diagnostic tool ensures the integrity of open and short corrections and connections to the DUT, displaying readings in real time.

For characterizing LDMOS structures, low  $\kappa$  interlayer dielectrics, MEMS devices, organic TFT displays, and photodiodes, an optional C-V Power Package allows making C-V measurements with a DC voltage bias of up to  $\pm 200\text{V}$  or  $400\text{V}$  differential and a current output of up to  $300\text{mA}$ . The software included supports making either high voltage C-V sweeps or capacitance measurements at a constant DC voltage.

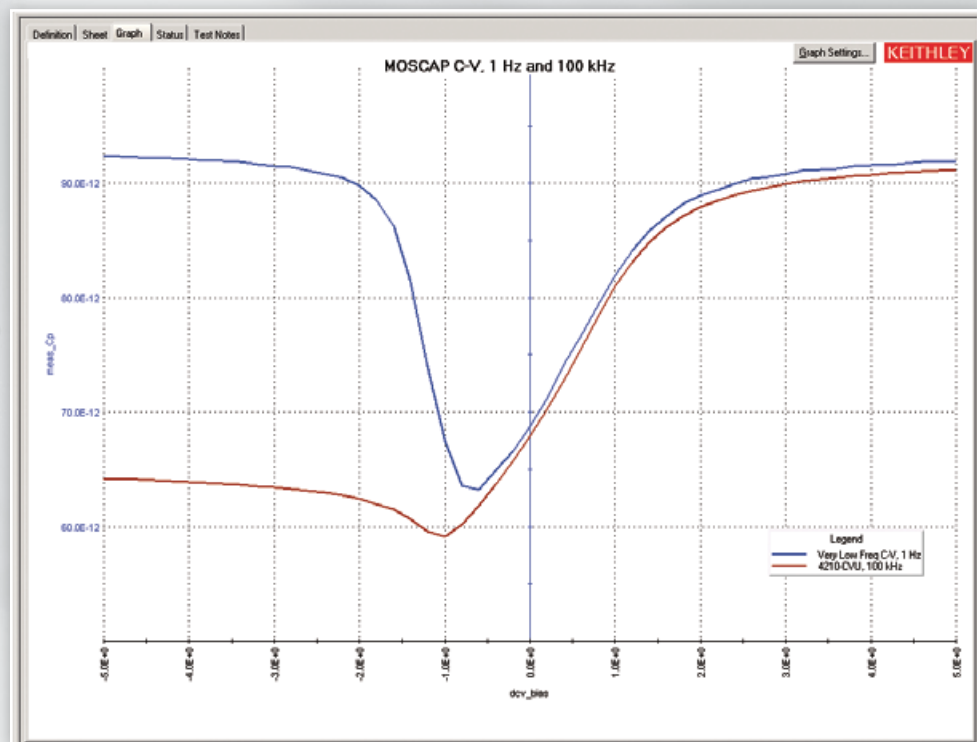

The very low frequency C-V (VLF C-V) technique takes advantage of the very low current measurement capability of the system's DC SMUs and low current remote pre-amplifier. It can measure AC impedances from 10mHz to 10Hz with no additional hardware. It's well suited for both MOS device applications and emerging technologies like organic electronics, including organic LEDs (OLEDs), organic FETs (OFETs), and organic photovoltaic cells (OPVCs), thin film transistors (TFTs), and microelectromechanical systems (MEMS).

INTUITIVE  
INTERFACE

# SIMPLIFIES DEVICE AND MATERIAL CHARACTERIZATION AND ANALYSIS

1

Define a test starting from any of more than 450 supplied sample libraries, using the system's intuitive point-and-click interface.

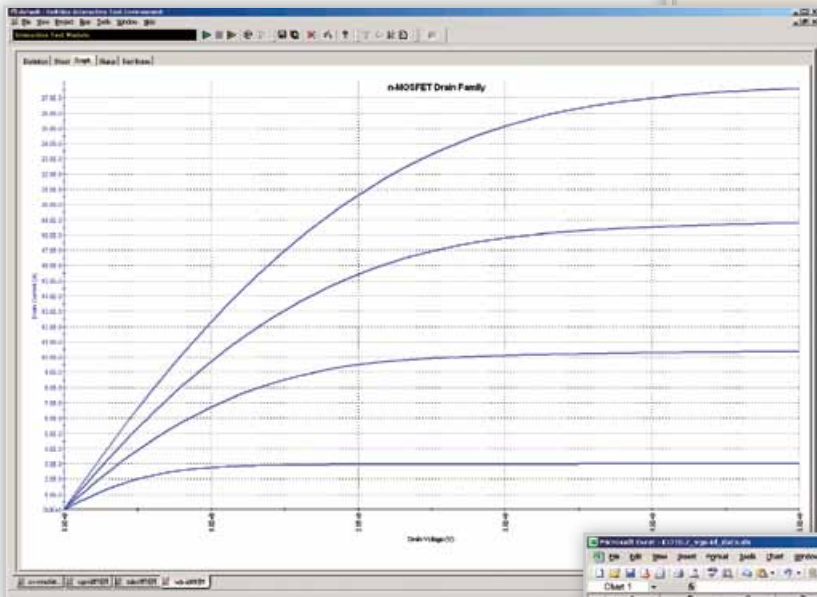
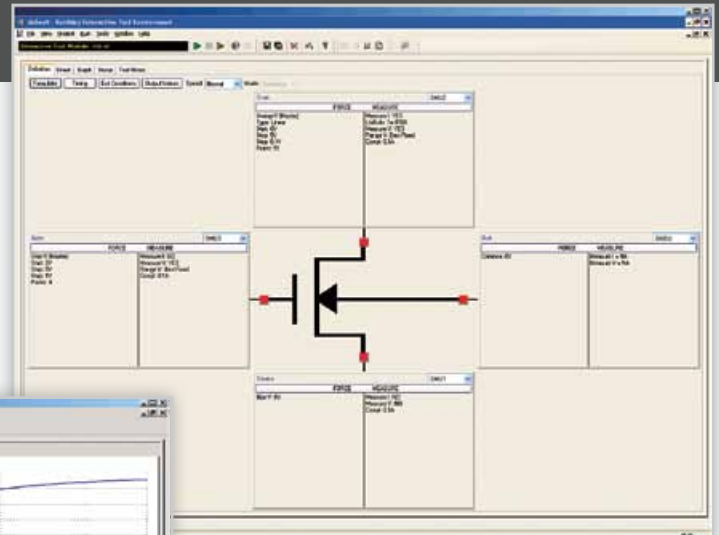

Click the on-screen Run button to start the test and view a real-time plot.

2

3

Export data in Excel workbook or ASCII formats and plots in .bmp, .jpg, or .tif formats for either online or offline analysis. Built-in Formulator, graphing, and calc sheet functions simplify complex analyses.

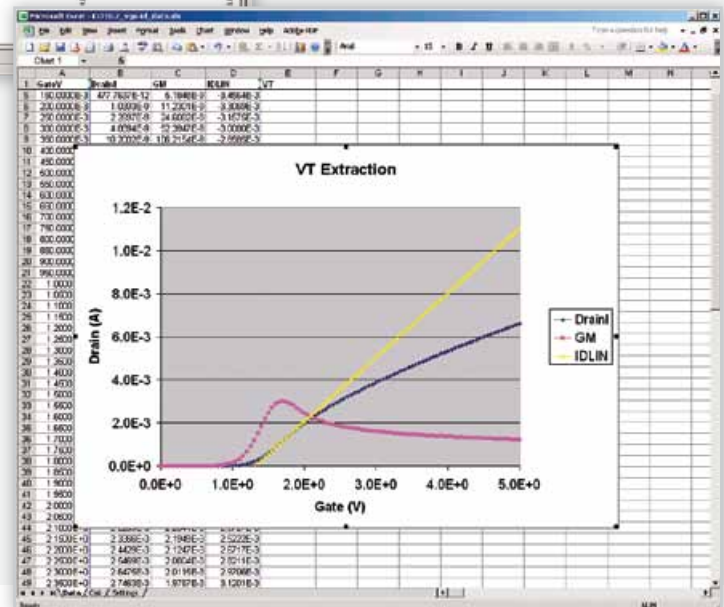



# AUTOMATED TEST SEQUENCES WITHOUT WRITING CODE

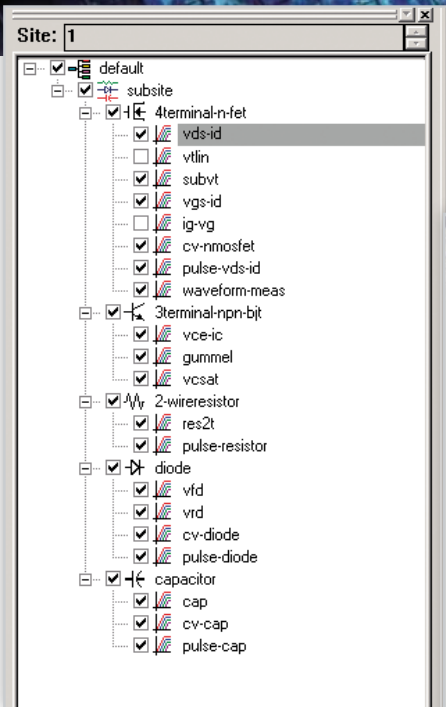

The Project Navigator organizes tests and controls test sequencing. Switching between different test setups and accessing test results is fast and simple. Sequence tests on a single device by clicking on the device in the Navigator, then clicking the Run button.

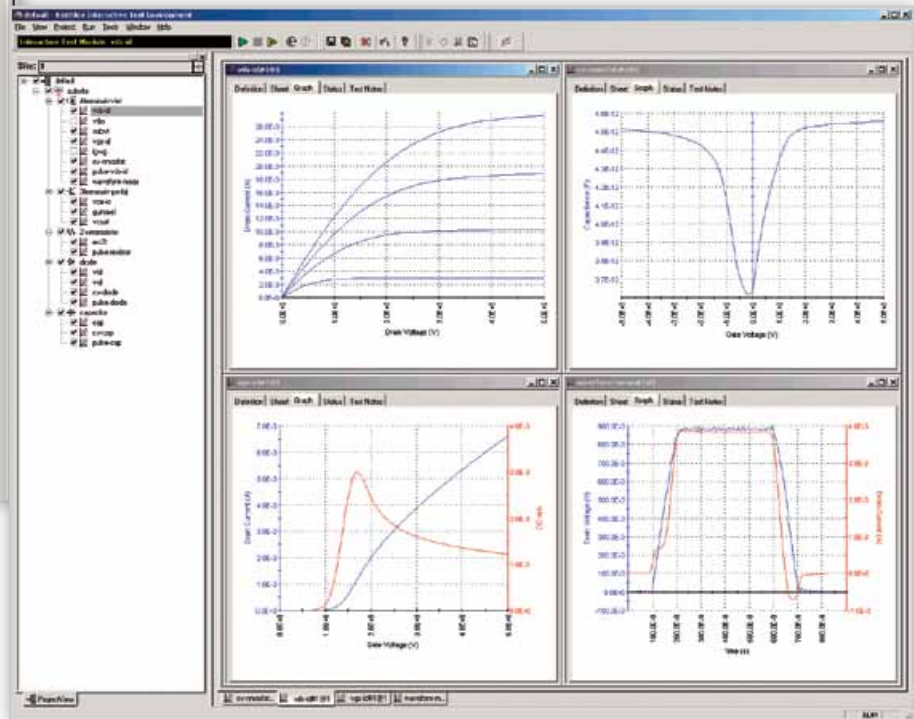

Keithley Interactive Test Environment (KITE) is designed to let users understand device behavior quickly. When running a test sequence, users can view results and plots for completed tests

while the sequence is still running. Multiple plots can be viewed at the same time to get a complete picture of device performance.

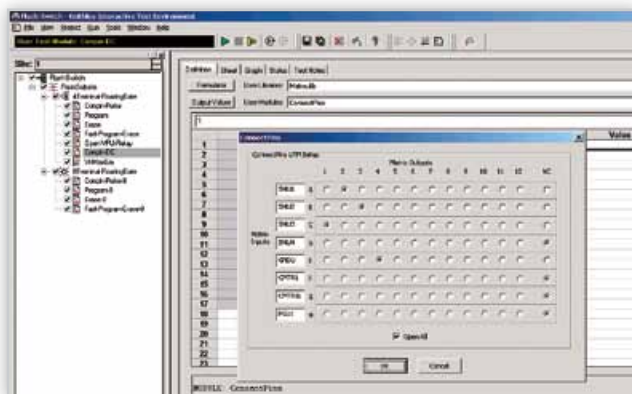

## Extend the Model 4200-SCS with C language test libraries

The User Test Module (UTM) feature in KITE lets the Model 4200-SCS take on advanced test algorithm requirements with user-written C++ code. These modules give lab users a “fill in the blank” interface to C language subroutines. Everything needed to collect, analyze, and report results is integrated in one application. UTMs support viewing and graphing data in real time to monitor test progress. The KULT User library Tool (KULT), in combination with the optional Model 4200-COMPILER, allows integrating these subroutines easily into a test sequence. Selected UTMs also have GUI interfaces to simplify test setups.

EXTEND YOUR  
SYSTEM'S  
CAPABILITIES

QUICKLY AND COST-EFFECTIVELY

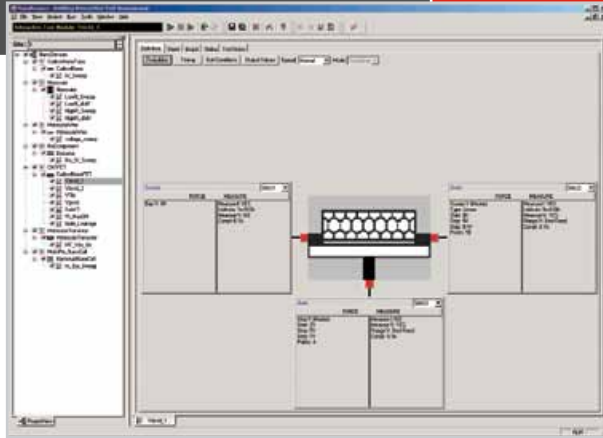

### Explore nanotechnology applications

The sample project and sample tests included in the Model 4200-SCS bring together the capabilities you need to create powerful nanotech R&D software applications. They can help you to focus on your research on carbon nanotubes, nanowires, and more by slashing the time needed to develop new applications or to refine them as new test requirements emerge. The Model 4200-SCS conforms to and supports IEEE Standard P1650™ -2005: IEEE Standard Test Methods for Measurement of Electrical Properties of Carbon Nanotubes.

### Characterize device lifetimes accurately and economically

The stress-measure capabilities included in the Keithley Interactive Test Environment (KITE) make the Model 4200-SCS ideal for both packaged level and wafer level reliability testing applications. The system's sequencer controls the order of stress-measure steps, and several JEDEC-compliant sample projects are provided with the system, including projects for standard WLR tests like Hot Carrier Injection or Channel Hot Carrier, Negative Bias Temperature Instability, Charge to Breakdown, and Electromigration. All of these projects are easily customizable to adapt to specific WLR testing requirements.

For reliability test applications that demand more advanced capabilities, the optional Model 4200-BTI-A Ultra-Fast BTI Package combines all the hardware and software needed for a broad range of ultra-fast NBTI/PBTI test applications.

- Best high speed, low current measurement sensitivity available in an integrated solution
- Supports building complex test sequences, including full probe integration
- Can handle the large data sets required in device reliability modeling and process monitoring applications

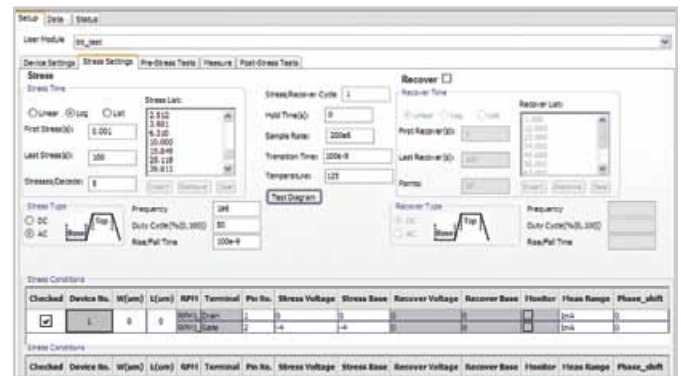

Define stress timing and stress conditions easily using familiar parameters like timing log, linear, custom list; measurements per decade; AC or DC stress; optional recovery test sequence; and test sample rate (speed).

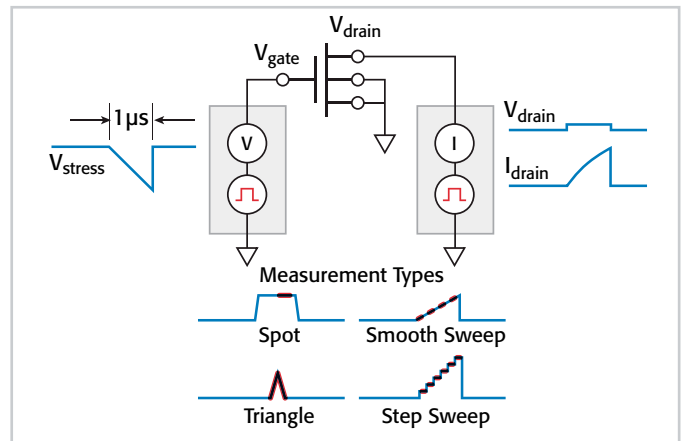

The Ultra-Fast BTI test software module supports spot, step sweep, smooth sweep, and sample measurement types. Each type's timing is defined by the test sample rate and the individual measurement settings. The software module also provides control over the voltage conditions between each element in the test sequence, for maximum flexibility and ease of use, even when defining complex test sequences.

To learn more, download our datasheet:  
**Model 4200-BTI-A Ultra-Fast NBTI/PBTI Package for the Model 4200-SCS.**



# NON-VOLATILE MEMORY (NVM) TEST LIBRARIES

New NVM test libraries expand the Model 4200-SCS's capabilities for testing all types of non-volatile memory devices and materials:

- Flash
- Phase change memory (PRAM and PC-RAM)
- Ferro-electric memory (FeRAM)
- Resistive memory (RRAM or ReRAM)
- Magneto-resistive memory (MRAM)
- Other NVM types

The NVM test libraries take advantage of the high speed capabilities of the Model 4225-PMU Ultra-Fast I-V Module and the Model 4225-RPM Remote Amplifier/Switch Module. They support precise sourcing of ultra-fast pulses, as well as accurate measurements of the transient signals produced during testing. Together, they let you perform all the typical characterization routines NVM testing requires with no need for external sense resistors, capacitors, or extra test hardware.

When a high speed pulse is sourced through an NVM device during characterization, high speed transient measurements are essential. These challenging measurements provide valuable information about the state of materials during and after the SET and RESET stages of testing. When equipped with both the Model 4225-PMU and Model 4225-RPM modules, the Model 4200-SCS is the only parameter analyzer on the market capable of sourcing high speed, user-defined pulses while measuring voltage and current simultaneously over a wide dynamic range and minimizing the negative effects of stray system capacitance.

The Model 4225-RPM module helps to simplify ultra-fast I-V testing configuration and dramatically reduces the time necessary to complete NVM measurement sequences. The module also extends the dynamic range of the system's ultra-fast I-V measurements, and allows fast switching between pulse source-measure and precision DC I-V measure. This combination of measurements is critical to several NVM test sequences.

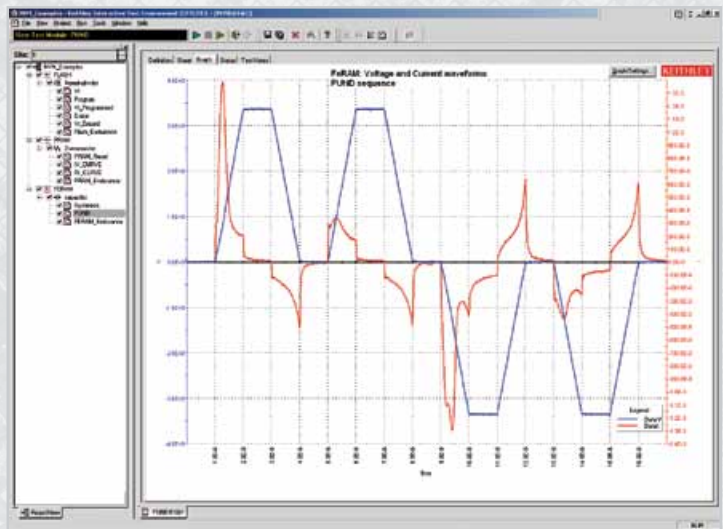

Sample projects are included for several memory types to provide the flexibility you need to set up and execute tests quickly, as well as to analyze the data. You can easily modify the examples provided for use with most emerging memory technologies.

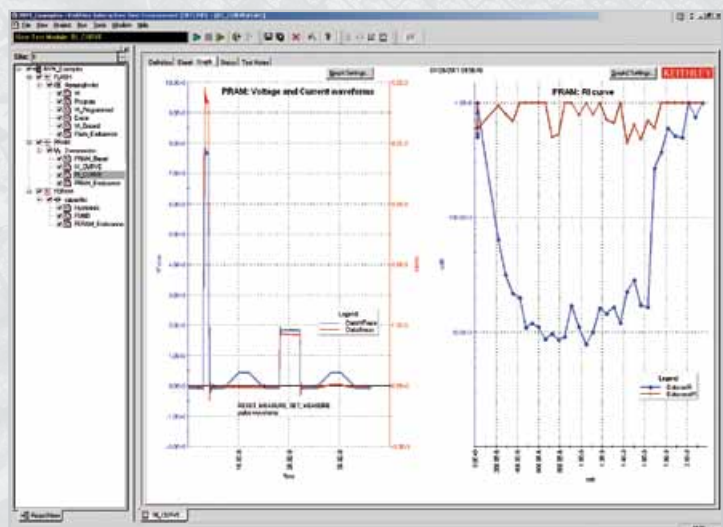

Results from a resistance-current (RI) curve test on a phase-change memory device.



## MODULAR ARCHITECTURE

## SIMPLIFIES SYSTEM INTEGRATION AND UPGRADES

### Integrated switching control

A choice of standard switch configurations simplifies finding the best match for the application. Based on Keithley's six-slot Model 707B or single-slot Model 708B switch matrix mainframes, they include all the components, cabling, and instructions needed to assemble the switch matrix and incorporate it into the Model 4200-SCS test environment. Once the switch is installed, users can connect instrument terminals to output pins quickly with a simple "fill-in-the-blank" interface in the Keithley Configuration Utility (KCON). No need to remember and program row and column closures—system applications and standard user libraries manage routing test signals from instruments to DUT pins. The GUI simplifies configuring switch connections.

- **Low current (<1pA) switch matrix configuration:**  
This configuration, which uses the Model 7072 switch card, is suitable for basic device characterization with or without optional Remote PreAmps.
- **Ultra-low current (<100fA) switch matrix configuration:**  
This configuration, which uses the Model 7174A switch card, is intended for high performance device characterization tasks when the system is equipped with optional Remote PreAmps.

### Control external hardware via GPIB with our built-in drivers

Need to incorporate an external source or instrument, switch matrix, or probe into your parameter analyzer? Just set the GPIB address, install the GPIB cable, and the Model 4200-SCS is ready to start testing. The User Test Modules we supply load external instrument data directly into the system's analysis and graphing tools.



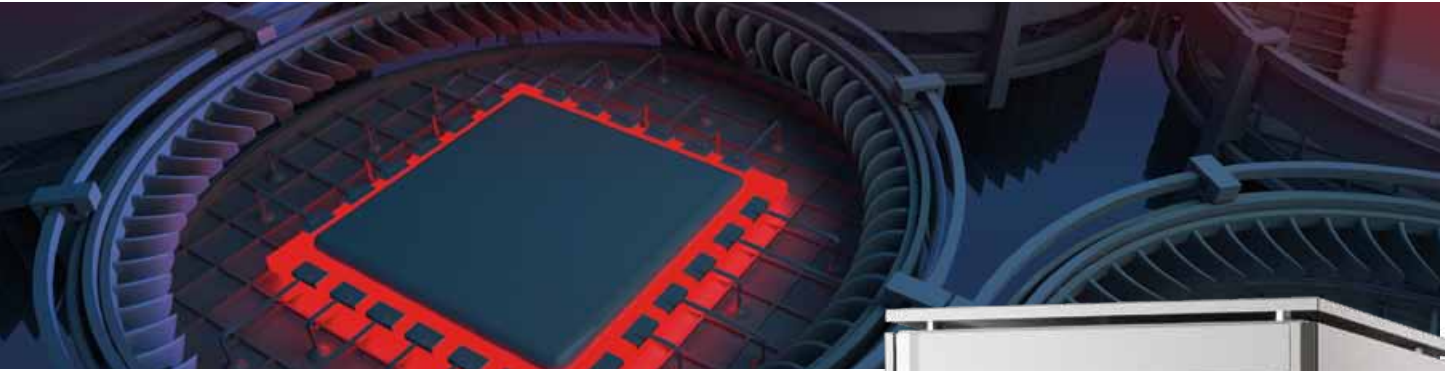

### **Advanced automation and system integration using Automated Characterization Suite (ACS) software**

ACS is a software option that can be applied to the Model 4200-SCS for more advanced automation with fully automatic probe stations, as well as for advanced reliability testing such as ultra-fast BTI. Use ACS interactively or in automation mode for testing at the device, wafer, or cassette level. ACS supports the full range of Keithley SourceMeter® instruments, switching systems, and the Model 4200-SCS, as well as a variety of GPIB instruments. ACS can also be applied to Keithley's S530 Parametric Test Systems and highly configurable S500 Integrated Test Systems.

ACS uses an open architecture that gives you greater programming flexibility without compromising ease of use. It supports integrating the Model 4200-SCS with a wide range of popular semi-automatic and fully automatic wafer probers. It simplifies a variety of complex system functions, including wafer description, test setup, interactive prober control, automation, and test summary report generation. It offers maximum operating flexibility by making it easy to switch between semi-automatic operation and fully automatic operation using the same test plan and environment.



# 4200-SCS

# CONDENSED SPECIFICATIONS

Note: See the **4200 Technical Data Sheet** for complete specifications.

## 4200-SCS CHASSIS CORE CAPABILITIES

Integrate Intel Core2Duo processor, 2Gb Ram, 500Gb HDD, 1024X768 LCD, 9 slots, USB, Ethernet, GPIB, external monitor, more than 200W of measurement power.

## 4200-SMU MEDIUM POWER SOURCE MEASURE UNIT (2.1 watts max.)

**Maximum Units per Chassis:** 9.

**Voltage Range:**  $\pm 210V$ , 4 ranges from 200mV to 210V full scale.

**Basic Voltage Accuracy:** 0.01% measure, 0.02% source.

**Voltage Resolution:** 0.1 $\mu V$  to 100 $\mu V$ .

**Current Range:**  $\pm 100mA$ , 7 ranges from 100nA to 100mA full scale.

**Basic Current Accuracy:** 0.03% measure, 0.04% source.

**Current Resolution:** 0.1pA to 100pA.

**With Optional 4200-PA:** Adds 5 low current ranges with resolution down to 0.1fA.

## 4210-SMU HIGH POWER SOURCE MEASURE UNIT (21 watts max.)

**Maximum Units per Chassis:** 9.

**Voltage Range:**  $\pm 210V$ , 4 ranges from 200mV to 210V full scale.

**Basic Voltage Accuracy:** 0.01% measure, 0.02% source.

**Voltage Resolution:** 0.1 $\mu V$  to 100 $\mu V$ .

**Current Range:**  $\pm 1A$ , 8 ranges from 100nA to 1A full scale.

**Basic Current Accuracy:** 0.03% measure, 0.04% source.

**Current Resolution:** 0.1pA to 100pA.

**With Optional 4200-PA:** Adds 5 low current ranges with resolution down to 0.1fA.

## 4210-CVU MULTI-FREQUENCY CAPACITANCE-VOLTAGE UNIT

**Maximum Units per Chassis:** 1.

**Measurement Parameters:** Cp-G, Cp-D, Cs-Rs, Cs-D, R-jX, Z theta.

**Frequency Range:** 1kHz to 10MHz variable.  
Minimum Resolution: 10kHz, 1MHz depending on frequency range.  
Source Frequency Accuracy:  $\pm 0.1\%$

**Measurement Ranges:** 100fF to 100 $\mu F$  typical full scale.

**Typical Resolution:** 1aF, 1nanoSiemens, 0.001 degree.

**AC Signal:** 10mV to 100mV programmable.  
Resolution: 1mVrms.  
Accuracy:  $\pm (10.0\% + 1mVrms)$  unloaded (at rear panel).

**DC Bias:**  $\pm 30V$  on either High or Low outputs ( $\pm 60V$  differential), 10mA max current.  
DC Voltage Bias Range:  $\pm 30V$   
Resolution: 1.0mV.

**Sweep Characteristics:** Available Sweep Parameters: DC bias voltage, frequency. AC Voltage

**Optional 4200-CVU-PWR-PKG:** Utilizes SMUs for  $\pm 200V$  (400V differential) up to 300mA.

## RAMP RATE QUASISTATIC C-V

**Required Instruments:** Two SMUs.

**Measurement Parameters:** Cp, DCV, timestamp.

**Range of Capacitance:** 1pF to 400pF.

**Ramp Rates:** 0.1V/s to 1V/s.

**DCV:**  $\pm 200V$ .

**Typical Accuracy:** 5% at 1V/s ramp rate.





### C-V POWER PACKAGE TYPICAL PERFORMANCE

<b>Measurement Parameters:</b>	Cp-Gp, DCV, timestamp.
<b>Range of Capacitance:</b>	1pF to 1nF.
<b>Test Signal:</b>	100kHz to 10MHz, 10mV to 100mV.
<b>DC Voltage Source:</b>	±200V with 5mV resolution.
<b>DC Current:</b>	100mA or 300mA maximum.
<b>Typical Cp Acc. @ 1MHz:</b>	1.0%.
<b>DC Current Sensitivity:</b>	10nA/V.
<b>SMU Bias Terminals Supported:</b>	4.

### VERY LOW FREQUENCY C-V (VLF C-V)

<b>Maximum Units per Chassis:</b>	Requires two SMUs (either Model 4200-SMU or 4210-SMU) and two Model 4200-PA Remote Preamplifiers. Any two SMUs/PAs can be used for a VLF C-V measurement.
<b>Measurement Parameters:</b>	CP-GP, Cp-D, Cs-Rs, Cs-D, R-jX, Z-Theta, DCV, timestamp
<b>Frequency Range:</b>	10mHz to 10Hz.
<b>Measurement Range:</b>	1pF to 10nF.
<b>Typical Resolution:</b>	3.5 digits, minimum typical 10fF.
<b>AC Signal:</b>	10mv to 3V RMS.
<b>DC Bias:</b>	±20V on the high terminal, minus the AC signal, 1µA maximum.

### 4225-PMU ULTRA-FAST I-V UNIT

<b>Maximum Units per Chassis:</b>	6 (12 channels).
<b>Channels per Unit:</b>	2 independent or synchronized.
<b>Voltage Range:</b>	±40V maximum (into high impedance), 2 ranges of 10V and 40V.
<b>Voltage Resolution:</b>	250µV, 750µV.
<b>Basic Voltage Measure Accuracy:</b>	0.25%.
<b>Current Range:</b>	±800mA, 4 ranges from 100µA to 800mA.
<b>Basic Current Measure Accuracy:</b>	0.25%.
<b>Pulse Waveform Timing:</b>	Pulse width from 60ns to 999ms in 10ns steps. Other timing parameters are adjustable from 20ns to 999ms in 10ns steps.
<b>Core A/D Converter:</b>	Two per channel (measure I and V simultaneously), 4 per unit, 200 MSa/s sample rate, 14 bits, 1MSa buffer per A/D.
<b>With Optional 4225-RPM Remote Amplifier/Switch:</b>	Adds 4 low current ranges 100nA, 1µA, 10µA, 1mA. It also switches sourcing/measurement between the Model 4225-PMU, Model 4210-CVU, Model 4200-SMU, and Model 4210-SMU.

\* Model 4220-PGU Pulse Generator Unit offers a voltage-sourcing-only alternative to the Model 4225-PMU.

### KEY DIGITAL OSCILLOSCOPE SPECIFICATIONS

<b>Bandwidth (50Ω):</b>	DC to 750MHz (4200-SCP2). DC to 250MHz (4200-SCP2HR).
<b>Channels:</b>	2 (BNC).
<b>Maximum Sample Rate:</b>	1.25 GSa/s per channel (4200-SCP2). DC to 250MHz (4200-SCP2HR). 2.5 GSa/s one channel interleaved (4200-SCP2). 200 MSa/s (4200-SCP2HR). 400 MSa/s interleaved (4200-SCP2HR).
<b>On-board Memory Buffers:</b>	Up to 1 MSa per channel.

## We back Keithley quality with Keithley support

To request applications assistance for the Model 4200-SCS within the United States, call our Applications Engineering Department on our toll-free hotline at **1-888- KEITHLEY** (534-8453) from 8:00 am to 5:00 pm ET. For assistance beyond those hours, send them a facsimile (440-248-6168) or an e-mail message ([applications@keithley.com](mailto:applications@keithley.com)).

For our customers outside the United States, our worldwide facilities and affiliates offer native language support services. See the list below or consult the listings at [www.keithley.com/company/servicecenters](http://www.keithley.com/company/servicecenters) for up-to-date contact information for these offices.

Customer assistance is also available through our free online applications forum at <http://forum.keithley.com>, a central location for finding product support and exchanging applications insights via the web. Keithley instrumentation and applications experts moderate the forum and can answer questions and direct visitors to sources of additional information.

### Ongoing system enhancements ensure ongoing ROI

Keithley has continually enhanced the Model 4200-SCS's hardware and software capabilities ever since its introduction in 2000. This ongoing commitment assures you of a cost-effective system upgrade path to address new characterization requirements as they evolve, so you'll never have to buy a new parametric analyzer because your old one is obsolete. The Model 4200-SCS can keep up with your changing test needs—making your capital investment stretch further and improving your ROI.

Visit [www.keithley.com](http://www.keithley.com) to download free copies of our latest literature on the Model 4200-SCS:

- **Model 4200-SCS Technical Data Sheet**
- **Ultra-Fast I-V Applications for the Model 4225-PMU Ultra-Fast I-V Module**
- **The Evolution of Ultra-Fast I-V Measurement Techniques**
- **Wafer Level Reliability Test Systems**
- **Ultra-Fast NBTI/PBTI Package for the Model 4200-SCS**
- **Electrical Characterization of Carbon Nanotube Transistors (CNT FETs) with the Model 4200-SCS Semiconductor Characterization System**
- **Electrical Characterization of Photovoltaic Materials and Solar Cells with the Model 4200-SCS Semiconductor Characterization System**
- **The Challenge of Integrating Three Critical Semiconductor Measurement Types into a Single Instrument Chassis**
- **Labs' Demands for Greater Measurement Flexibility Require Cabling Systems Capable of Accommodating Multiple Measurement Types**
- **Using the Model 4200-CVU-PWR C-V Power Package**
- **C-V Measurement Tips, Tricks, and Traps**

Specifications are subject to change without notice.

All Keithley trademarks and trade names are the property of Keithley Instruments, Inc.  
All other trademarks and trade names are the property of their respective companies.

# KEITHLEY

A G R E A T E R M E A S U R E O F C O N F I D E N C E

KEITHLEY INSTRUMENTS, INC. ■ 28775 AURORA RD. ■ CLEVELAND, OH 44139-1891 ■ 440-248-0400 ■ Fax: 440-248-6168 ■ 1-888-KEITHLEY ■ [www.keithley.com](http://www.keithley.com)

#### BELGIUM

Sint-Pieters-Leeuw  
Ph: 02-3630040  
Fax: 02-3630064  
[info@keithley.nl](mailto:info@keithley.nl)  
[www.keithley.nl](http://www.keithley.nl)

#### CHINA

Beijing  
Ph: 86-10-8447-5556  
Fax: 86-10-8225-5018  
[china@keithley.com](mailto:china@keithley.com)  
[www.keithley.com.cn](http://www.keithley.com.cn)

#### FRANCE

Saint-Aubin  
Ph: 01-64532020  
Fax: 01-60117726  
[info@keithley.fr](mailto:info@keithley.fr)  
[www.keithley.fr](http://www.keithley.fr)

#### GERMANY

Germering  
Ph: 089-84930740  
Fax: 089-84930734  
[info@keithley.de](mailto:info@keithley.de)  
[www.keithley.de](http://www.keithley.de)

#### INDIA

Bangalore  
Ph: 080-26771071, -72, -73  
Fax: 080-26771076  
[support\\_india@keithley.com](mailto:support_india@keithley.com)  
[www.keithley.com](http://www.keithley.com)

#### ITALY

Peschiera Borromeo (Mi)  
Ph: 02-5538421  
Fax: 02-55384228  
[info@keithley.it](mailto:info@keithley.it)  
[www.keithley.it](http://www.keithley.it)

#### JAPAN

Tokyo  
Ph: 81-3-5733-7555  
Fax: 81-3-5733-7556  
[info.jp@keithley.com](mailto:info.jp@keithley.com)  
[www.keithley.jp](http://www.keithley.jp)

#### KOREA

Seoul  
Ph: 82-2-574-7778  
Fax: 82-2-574-7838  
[keithley@keithley.co.kr](mailto:keithley@keithley.co.kr)  
[www.keithley.co.kr](http://www.keithley.co.kr)

#### MALAYSIA

Penang  
Ph: 60-4-643-9679  
Fax: 60-4-643-3794  
[sea@keithley.com](mailto:sea@keithley.com)  
[www.keithley.com](http://www.keithley.com)

#### NETHERLANDS

Son  
Ph: 0183-635333  
Fax: 0183-630821  
[info@keithley.nl](mailto:info@keithley.nl)  
[www.keithley.nl](http://www.keithley.nl)

#### SINGAPORE

Singapore  
Ph: 65-6747-9077  
Fax: 65-6747-2991  
[sea@keithley.com](mailto:sea@keithley.com)  
[www.keithley.com](http://www.keithley.com)

#### SWITZERLAND

Zürich  
Ph: 044-8219444  
Fax: 044-8203081  
[info@keithley.ch](mailto:info@keithley.ch)  
[www.keithley.ch](http://www.keithley.ch)

#### TAIWAN

Hsinchu  
Ph: 886-3-572-9077  
Fax: 886-3-572-9031  
[info\\_tw@keithley.com](mailto:info_tw@keithley.com)  
[www.keithley.com.tw](http://www.keithley.com.tw)

#### UNITED KINGDOM

Theale  
Ph: 0118-9297500  
Fax: 0118-9297519  
[info@keithley.co.uk](mailto:info@keithley.co.uk)  
[www.keithley.co.uk](http://www.keithley.co.uk)