

# 2260B Series

360W and 720W Multi-Range Programmable DC Power  
Supplies

## User Manual

Rev. A / March 2014

A Greater Measure of Confidence



# Series 2260B

360W and 720W Multi-Range Programmable DC Power  
Supplies

---

## USER MANUAL



ISO-9001 CERTIFIED MANUFACTURER

This manual contains proprietary information, which is protected by copyright. All rights are reserved. No part of this manual may be photocopied, reproduced or translated to another language without prior written consent.

The information in this manual was correct at the time of printing. However, we continue to improve our products and reserve the rights to change specification, equipment, and maintenance procedures at any time without notice.

---

---

# Table of Contents

<b>SAFETY INSTRUCTIONS .....</b>	<b>3</b>
<b>GETTING STARTED .....</b>	<b>7</b>
2260B Series Overview .....	8
Appearance .....	12
Theory of Operation .....	18
<b>OPERATION .....</b>	<b>30</b>
Set Up .....	31
Basic Operation .....	43
Parallel / Series Operation .....	56
Test Sequence .....	71
<b>CONFIGURATION .....</b>	<b>83</b>
Configuration .....	84
<b>ANALOG CONTROL .....</b>	<b>98</b>
Analog Remote Control Overview .....	99
Remote Monitoring .....	115
<b>COMMUNICATION INTERFACE .....</b>	<b>120</b>
Interface Configuration .....	121
<b>MAINTENANCE .....</b>	<b>132</b>
<b>FAQ .....</b>	<b>134</b>
<b>APPENDIX .....</b>	<b>136</b>
2260B Default Settings .....	136
Error Messages & Messages .....	138
LED Display Format .....	138

2260B Specifications ..... 139  
2260B Dimensions ..... 145  
Declaration of Conformity ..... 147

**INDEX.....148**

# SAFETY INSTRUCTIONS

This chapter contains important safety instructions that you must follow during operation and storage. Read the following before any operation to insure your safety and to keep the instrument in the best possible condition.

## Safety Symbols

These safety symbols may appear in this manual or on the instrument.

---



WARNING

Warning: Identifies conditions or practices that could result in injury or loss of life.



CAUTION

Caution: Identifies conditions or practices that could result in damage to the instrument or to other properties.



DANGER High Voltage



Attention Refer to the Manual



Protective Conductor Terminal



Earth (ground) Terminal



Do not dispose electronic equipment as unsorted municipal waste. Please use a separate collection facility or contact the supplier from which this instrument was purchased.

## Safety Guidelines

---

General Guideline • Do not place any heavy object on the instrument.



CAUTION

- Avoid severe impact or rough handling that leads to damaging the instrument.
- Do not discharge static electricity to the instrument.
- Use only mating connectors, not bare wires, for the terminals.
- Do not block the cooling fan opening.
- Do not disassemble the instrument unless you are qualified.

(Measurement categories) EN 61010-1:2001 specifies the measurement categories and their requirements as follows. This instrument falls under category II.

- Measurement category IV is for measurement performed at the source of low-voltage installation.
- Measurement category III is for measurement performed in the building installation.
- Measurement category II is for measurement performed on the circuits directly connected to the low voltage installation.
- Measurement category I is for measurements performed on circuits not directly connected to Mains.

---

Power Supply



WARNING

- AC Input voltage range: 85VAC~265VAC
  - Frequency: 47Hz~63Hz
  - To avoid electrical shock connect the protective grounding conductor of the AC power cord to an earth ground.
-

- 
- |                         |                                                                                                                                                                                                                                                                                                              |
|-------------------------|--------------------------------------------------------------------------------------------------------------------------------------------------------------------------------------------------------------------------------------------------------------------------------------------------------------|
| Cleaning the Instrument | <ul style="list-style-type: none"><li>• Disconnect the power cord before cleaning.</li><li>• Use a soft cloth dampened in a solution of mild detergent and water. Do not spray any liquid.</li><li>• Do not use chemicals containing harsh material such as benzene, toluene, xylene, and acetone.</li></ul> |
|-------------------------|--------------------------------------------------------------------------------------------------------------------------------------------------------------------------------------------------------------------------------------------------------------------------------------------------------------|
- 

- |                       |                                                                                                                                                                                                                                                                                                                                                                                                                                                                                                                                                                                                                                                                                                                                                                                                                                                                                                                                                                                                                                                                                                                                                                                                                                                                                         |
|-----------------------|-----------------------------------------------------------------------------------------------------------------------------------------------------------------------------------------------------------------------------------------------------------------------------------------------------------------------------------------------------------------------------------------------------------------------------------------------------------------------------------------------------------------------------------------------------------------------------------------------------------------------------------------------------------------------------------------------------------------------------------------------------------------------------------------------------------------------------------------------------------------------------------------------------------------------------------------------------------------------------------------------------------------------------------------------------------------------------------------------------------------------------------------------------------------------------------------------------------------------------------------------------------------------------------------|
| Operation Environment | <ul style="list-style-type: none"><li>• Location: Indoor, no direct sunlight, dust free, almost non-conductive pollution (Note below)</li><li>• Relative Humidity: 20%~ 85%</li><li>• Altitude: &lt; 2000m</li><li>• Temperature: 0°C to 50°C</li></ul> <p>(Pollution Degree) EN 61010-1:2001 specifies the pollution degrees and their requirements as follows. The Instrument falls under degree 2.</p> <p>Pollution refers to “addition of foreign matter, solid, liquid, or gaseous (ionized gases), that may produce a reduction of dielectric strength or surface resistivity”.</p> <ul style="list-style-type: none"><li>• Pollution degree 1: No pollution or only dry, non-conductive pollution occurs. The pollution has no influence.</li><li>• Pollution degree 2: Normally only non-conductive pollution occurs. Occasionally, however, a temporary conductivity caused by condensation must be expected.</li><li>• Pollution degree 3: Conductive pollution occurs, or dry, non-conductive pollution occurs which becomes conductive due to condensation which is expected. In such conditions, equipment is normally protected against exposure to direct sunlight, precipitation, and full wind pressure, but neither temperature nor humidity is controlled.</li></ul> |
|-----------------------|-----------------------------------------------------------------------------------------------------------------------------------------------------------------------------------------------------------------------------------------------------------------------------------------------------------------------------------------------------------------------------------------------------------------------------------------------------------------------------------------------------------------------------------------------------------------------------------------------------------------------------------------------------------------------------------------------------------------------------------------------------------------------------------------------------------------------------------------------------------------------------------------------------------------------------------------------------------------------------------------------------------------------------------------------------------------------------------------------------------------------------------------------------------------------------------------------------------------------------------------------------------------------------------------|
- 

- |                     |                                                                                                                                              |
|---------------------|----------------------------------------------------------------------------------------------------------------------------------------------|
| Storage environment | <ul style="list-style-type: none"><li>• Location: Indoor</li><li>• Temperature: -25°C to 70°C</li><li>• Relative Humidity: &lt;90%</li></ul> |
|---------------------|----------------------------------------------------------------------------------------------------------------------------------------------|
- 

**Disposal**

Do not dispose this instrument as unsorted municipal waste. Please use a separate collection facility or contact the supplier from which this instrument was purchased. Please make sure discarded electrical waste is properly recycled to reduce environmental impact.



## Power cord for the United Kingdom

When using the instrument in the United Kingdom, make sure the power cord meets the following safety instructions.

NOTE: This lead/appliance must only be wired by competent persons



**WARNING: THIS APPLIANCE MUST BE EARTHED**

IMPORTANT: The wires in this lead are coloured in accordance with the following code:

Green/ Yellow:	Earth
Blue:	Neutral
Brown:	Live (Phase)



As the colours of the wires in main leads may not correspond with the coloured marking identified in your plug/appliance, proceed as follows:

The wire which is coloured Green & Yellow must be connected to the Earth terminal marked with either the letter E, the earth symbol  $\oplus$  or coloured Green/Green & Yellow.

The wire which is coloured Blue must be connected to the terminal which is marked with the letter N or coloured Blue or Black.

The wire which is coloured Brown must be connected to the terminal marked with the letter L or P or coloured Brown or Red.

If in doubt, consult the instructions provided with the equipment or contact the supplier.

This cable/appliance should be protected by a suitably rated and approved HBC mains fuse: refer to the rating information on the equipment and/or user instructions for details. As a guide, a cable of 0.75mm<sup>2</sup> should be protected by a 3A or 5A fuse. Larger conductors would normally require 13A types, depending on the connection method used.

Any exposed wiring from a cable, plug or connection that is engaged in a live socket is extremely hazardous. If a cable or plug is deemed hazardous, turn off the mains power and remove the cable, any fuses and fuse assemblies. All hazardous wiring must be immediately destroyed and replaced in accordance to the above standard.

# GETTING STARTED

This chapter describes the power supply in a nutshell, including its main features and front / rear panel introduction. After going through the overview, please read the theory of operation to become familiar with the operating modes, protection modes and other safety considerations.



<b>2260B Series Overview .....</b>	<b>8</b>
Series lineup.....	8
Main Features .....	9
Accessories.....	10
Package Contents.....	11
<b>Appearance .....</b>	<b>12</b>
2260B Front Panel.....	12
Rear Panel .....	15

## 2260B Series Overview

### Series lineup

The 2260B series consists of 4 models, divided into 2 different model types covering 2 power capacities: 360W models and 720W models.

Model name	Type	Voltage rating	Current rating	Power
2260B-30-36	360W models	0~30V	0~36A	360W
2260B-80-13	360W models	0~80V	0~13.5A	360W
2260B-30-72	720W models	0~30V	0~72A	720W
2260B-80-27	720W models	0~80V	0~27A	720W

Apart from the differences in output, each unit differs in size. The 720W models are larger than the 360W models to accommodate the increase in power.

### 360 Watt models



### 720 Watt models



## Main Features

---

- |             |                                                                                                                                                                                                                                                                                                                                                                                                                                                  |
|-------------|--------------------------------------------------------------------------------------------------------------------------------------------------------------------------------------------------------------------------------------------------------------------------------------------------------------------------------------------------------------------------------------------------------------------------------------------------|
| Performance | <ul style="list-style-type: none"><li>• High performance/power</li><li>• Power efficient switching type power supply</li><li>• Low impact on load devices</li><li>• Fast transient recovery time of 1ms</li><li>• Fast output response time</li></ul>                                                                                                                                                                                            |
| Features    | <ul style="list-style-type: none"><li>• OVP, OCP and OTP protection</li><li>• Adjustable voltage and current slew rates</li><li>• User adjustable bleeder control to quickly dissipate the power after shutdown to safe levels.</li><li>• Extensive remote monitoring and control options</li><li>• Support for serial and parallel connections</li><li>• Power on configuration settings.</li><li>• Web server monitoring and control</li></ul> |
| Interface   | <ul style="list-style-type: none"><li>• Ethernet port</li><li>• Analog connector for analog voltage and current monitoring</li><li>• USB host and device port</li></ul>                                                                                                                                                                                                                                                                          |

## Accessories

Standard Accessories	Part number	Description
	196353000	Test Leads x1
	174627900	USB Cable
	020312300	Basic Accessories Kit: M4 terminal screws and washers x2, M8 terminal bolts, nuts and washers x2, Air filter x1, Analog control protection dummy x1, Analog control lock lever x1, Output terminal cover (top & bottom)
	063453400	CD-R 2260B Manuals & Drivers
	071305501	Quick Start Guide
	PWRKI A*_	Power cord
	071305700	China RoHS Declaration
	001163200	Calibration of Traceable Certificate
	001163300	Packing Check List
Optional Accessories	Part number	Description
	2260B-EXTERM	Extended terminal
	2260B-RMK-JIS	Rack mount adapter (JIS)
	2260B-RMK-EIA	Rack mount adapter (EIA)
	2260B-GPIB-USB	GPIB to USB adapter
Download	Name	Description
	keithley_2260B.inf	USB driver

## Package Contents

Check the contents before using the 2260B.

---

Opening the box

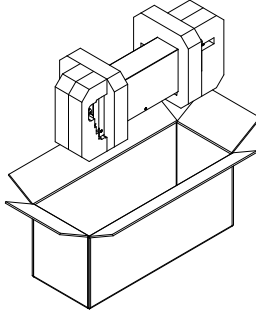

---

Contents  
(single unit)

- Main unit
- Test leads x1
- USB cable
- Basic Accessories Kit
- CD-R Manual
- Quick Start Guide
- Power cord x1
- China RoHS Declaration
- Calibration of Traceable Certificate
- Packing Check List

# Appearance

## 2260B Front Panel

2260B-80-27, 2260B-30-72 (720W)

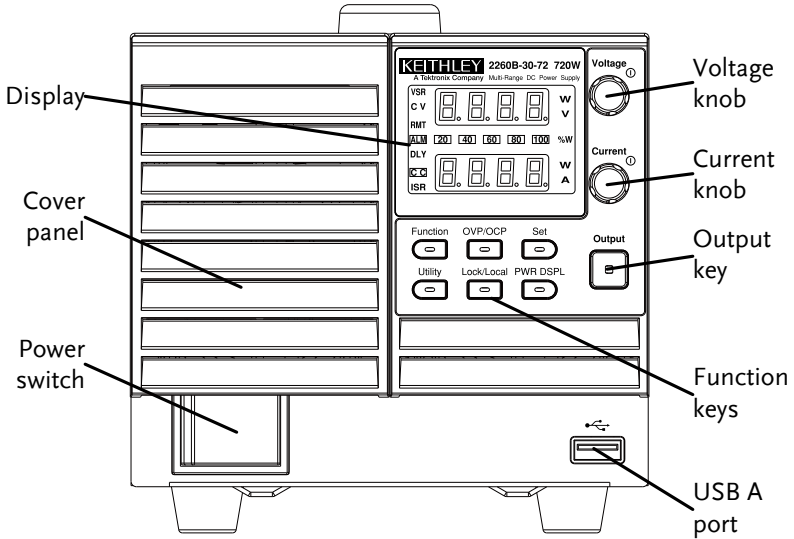

2260B-80-13, 2260B-30-36 (360W)

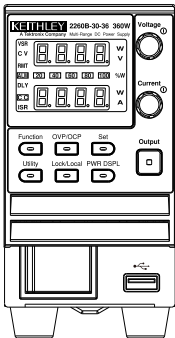

Function Keys      The Function keys along with the Output key will light up when a key is active.

Function



The Function key is used to configure the power supply.

OVP/OCP



Set the overcurrent or overvoltage protection levels.

Set



Sets the current and voltage limits.

Utility



Used to run customized Test sequence for testing.

Lock/Local



Locks or unlocks the panel keys to prevent accidentally changing panel settings.

PWR DSPL



Toggles the display from viewing V/A→V/W→A/W.

Display Indicators

VSR

Voltage Slew Rate

C V

Constant Voltage Mode

RMT

Remote Control Mode

**ALM**

Alarm on

DLY

Delay Output

**CC**

Constant Current Mode

ISR

Current Slew Rate

**20**   **40**   **60**

Power bar

**80**   **100**   % W

Indicates the current power output as a percentage.



Voltage Knob

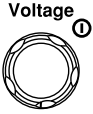

Sets the voltage.

Current Knob

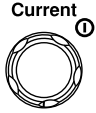

Sets the current.

Output

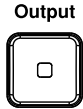

Press to turn on the output. The Output key will light up when the output is active.

USB

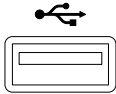

The USB A port is used to update the firmware. The firmware can only be updated at a service center.

Power Switch

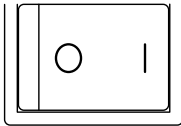

Used to turn the power on/off.

## Rear Panel

2260B-80-27, 2260B-30-72 (720W)

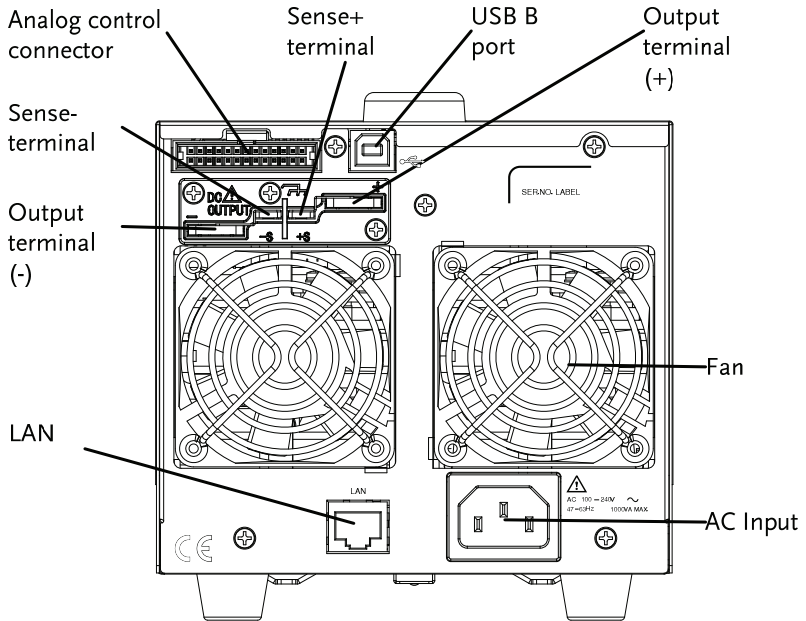

2260B-80-13, 2260B-30-36 (360W)

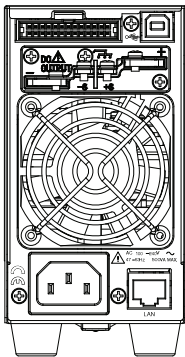

Analog Control Connector



Standard 26 pin MII connector (OMRON XG4 IDC plug).

The analog control connector is used to monitor current and voltage output, machine status (OVP, OCP, OTP etc.), and for analog control of the current and voltage output.

Use an OMRON XG5 IDC socket as the mating socket.

Output Terminals

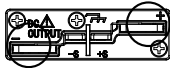

Positive (+) and negative (-) output terminals.

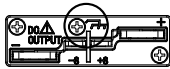

Chassis ground



Sense (-) and Sense (+) terminals.

USB B port

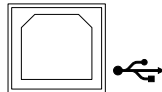

The USB B port is used for remote control.

Fans

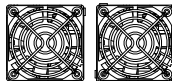

Temperature controlled fans

Ethernet Port

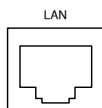

The Ethernet port is used for remote control and digital monitoring from a PC.

Line Voltage  
Input

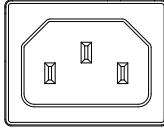

360W models: 2260B-30-36/2260B-80-13

720W models: 2260B-30-72/2260B-80-27

- Voltage Input: 100~240 VAC
- Line frequency: 50Hz/60 Hz (Automatically switchable)

## Theory of Operation

The theory of operation chapter describes the basic principles of operation, protection modes and important considerations that must be taken into account before use.

### Operating Area Description

#### Background

The 2260B power supplies are regulated DC power supplies with a high voltage and current output. These operate in CC (Constant current) or CV (Constant voltage) mode within a wide operating range limited only by the output power.

The operating area of each power supply is determined by the rated output power as well as the voltage and current rating. For example, the operating area and rated power output for the 2260B-30-36 is shown below.

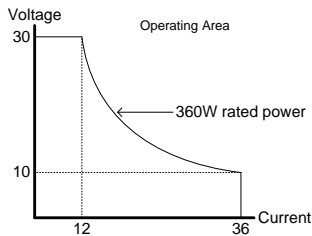

When the power supply is configured so that the total output (current x voltage output) is less than the rated power output, the power supply functions as a typical constant current, constant voltage power supply.

If however, the power supply is configured such that the total output (current x voltage

output) exceeds the rated power output, the effective output is actually limited to the power limit of the unit. In this case the output current and voltage then depend purely on the load value.

Below is a comparison of the operating areas of each power supply.

2260B 80V Series Operating Area

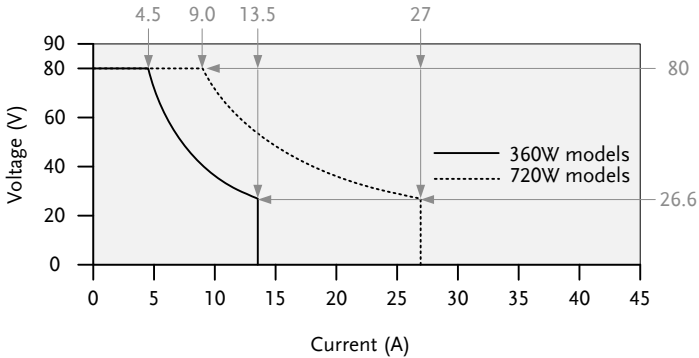

2260B 30V Series Operating Area

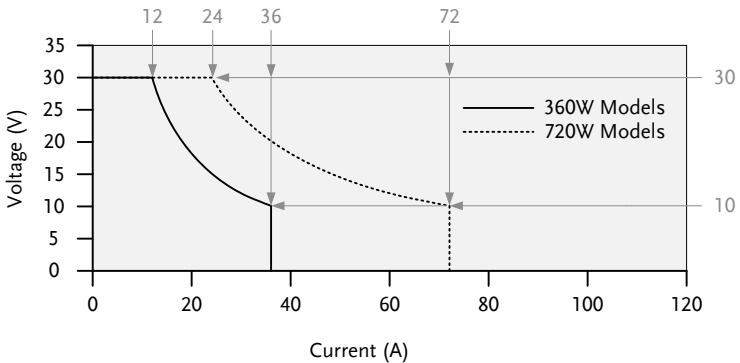

## CC and CV Mode

---

### CC and CV mode Description

When the power supply is operating in constant current mode (CC) a constant current will be supplied to the load. When in constant current mode the voltage output can vary, while the current remains constant. When the load resistance increases to the point where the current limit ( $I_{SET}$ ) can no longer be sustained the power supply switches to CV mode. The point where the power supply switches modes is the crossover point.

When the power supply is operating in CV mode, a constant voltage will be supplied to the load, while the current will vary as the load varies. At the point that the load resistance is too low to maintain a constant voltage, the power supply will switch to CC mode and maintain the set current limit.

The conditions that determine whether the power supply operates in CC or CV mode depends on the set current ( $I_{SET}$ ), the set voltage ( $V_{SET}$ ), the load resistance ( $R_L$ ) and the critical resistance ( $R_C$ ). The critical resistance is determined by  $V_{SET}/I_{SET}$ . The power supply will operate in CV mode when the load resistance is greater than the critical resistance. This means that the voltage output will be equal to the  $V_{SET}$  voltage but the current will be less than  $I_{SET}$ . If the load resistance is reduced to the point that the current output reaches the  $I_{SET}$  level, the power supply switches to CC mode.

Conversely the power supply will operate in CC mode when the load resistance is less than the critical resistance. In CC mode the current output is equal to  $I_{SET}$  and the voltage output is less than  $V_{SET}$ .

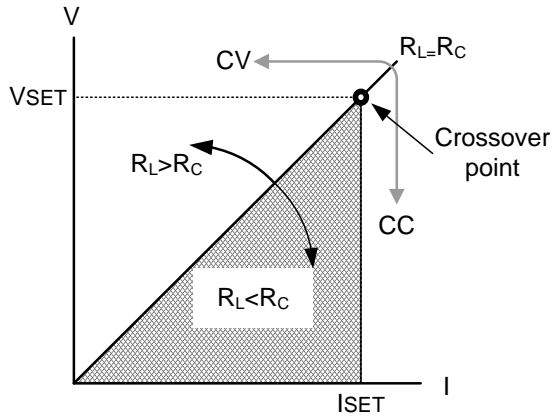



## Slew Rate

### Theory

The 2260B has selectable slew rates for CC and CV mode. This gives the 2260B power supply the ability to limit the current/ voltage draw of the power supply. Slew rate settings are divided into High Speed Priority and Slew Rate Priority. High Speed Priority mode disables slew rate settings for CC or CV mode. Slew Rate Priority mode allows for user adjustable slew rates for CC or CV mode. The rising and falling slew rate can be set independently.

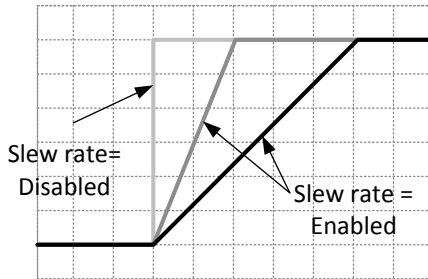

## Bleeder Control

### Background

The 2260B DC power supplies employ a bleed resistor in parallel with the output terminals.

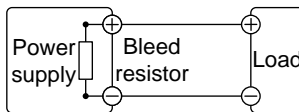

Bleed resistors are designed to dissipate the power from the power supply filter capacitors when power is turned off and the load is disconnected. Without a bleed resistor, power

may remain charged on the filter capacitors for some time and be potentially hazardous.

In addition, bleed resistors also allow for smoother voltage regulation of the power supply as the bleed resistor acts as a minimum voltage load.

The bleed resistance can be turned on or off using the configuration settings.



Note

By default the bleed resistance is on. For battery charging applications, be sure to turn the bleed resistance off as the bleed resistor can discharge the connected battery when the unit is off.

## Internal Resistance

### Background

On the 2260B, the internal resistance of the power supply can be user-defined in software. (Internal Resistance Setting, page 87). When the internal resistance is set it can be seen as a resistance in series with the positive output terminal. This allows the power supply to simulate power sources that have internal resistances such as lead acid batteries.

Internal Resistance Range	Unit Model	Internal Resistance Range
	2260B-30-36	0.000 ~ 0.833Ω
	2260B-30-72	0.000 ~ 0.417Ω
	2260B-80-13	0.000 ~ 5.926Ω
	2260B-80-27	0.000 ~ 2.963Ω

## Alarms

The 2260B power supplies have a number of protection features. When one of the protection alarms are set, the ALM icon on the display will be lit. For details on how to set the protection modes, please see page 43.

---

OVP	Overvoltage protection (OVP) prevents a high voltage from damaging the load.
OCP	Overcurrent protection prevents high current from damaging the load.
OTP	Overtemperature protection protects the instrument from overheating.
Power Switch Trip	When the Power Switch Trip configuration setting is enabled, the power supply will automatically shut down when a protection setting has been tripped (OCP, OVP, OTP).
Alarm output	Alarms are output via the analog control connector. The alarm output is an isolated open-collector photo coupler output.

## Considerations

The following situations should be taken into consideration when using the power supply.

---

**Inrush current**                      When the power supply switch is first turned on, an inrush current is generated. Ensure there is enough power available for the power supply when first turned on, especially if a number of units are turned on at the same time.

---



Allow at least 15 seconds between cycling the power. Cycling the power on and off quickly can cause the inrush current limiting circuit to fail as well as reduce the working life of the input fuse and power switch.

---

**Pulsed or Peaked loads**                      When the load has current peaks or is pulsed, it is possible for the maximum current to exceed the mean current value. The 2260B power supply ammeter only indicates mean current values, which means for pulsed current loads, the actual current can exceed the indicated value. For pulsed loads, the current limit must be increased, or a power supply with a greater capacity must be chosen. As shown below, a pulsed load may exceed the current limit and the indicated current on the power supply ammeter.

---

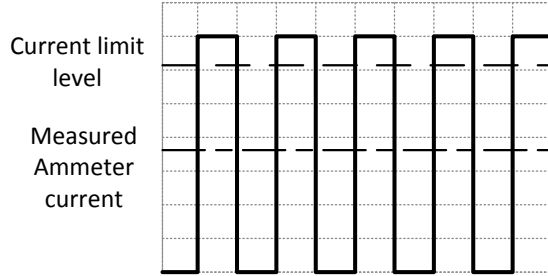

### Reverse Current: Regenerative load

When the power supply is connected to a regenerative load such as a transformer or inverter, reverse current will feed back to the power supply. The 2260B power supply cannot absorb reverse current. For loads that create reverse current, connect a resistor in parallel to the power supply to bypass the reverse current. This description only applies when the bleed resistance is off.

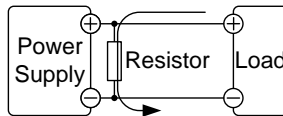

Reverse current



Note

The current output will decrease by the amount of current absorbed by the resistor.

Ensure the resistor used can withstand the power capacity of the power supply/load.

Reverse Current:  
Accumulative  
energy.

When the power supply is connected to a load such as a battery, reverse current may flow back to the power supply. To prevent damage to the power supply, use a reverse-current-protection diode in series between the power supply and load.

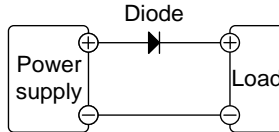

### CAUTION

Ensure the reverse withstand voltage of the diode is able to withstand 2 times the rated output voltage of the power supply and the forward current capacity can withstand 3 to 10 times the rated output current of the power supply.

Ensure the diode is able to withstand the heat generated in the following scenarios.

When the diode is used to limit reverse voltage, remote sensing cannot be used.

## Grounding

The output terminals of the 2260B power supplies are isolated with respect to the protective grounding terminal. The insulation capacity of the load, the load cables and other connected devices must be taken into consideration when connected to the protective ground or when floating.

### Floating

As the output terminals are floating, the load and all load cables must have an insulation capacity that is greater than the isolation voltage of the power supply.

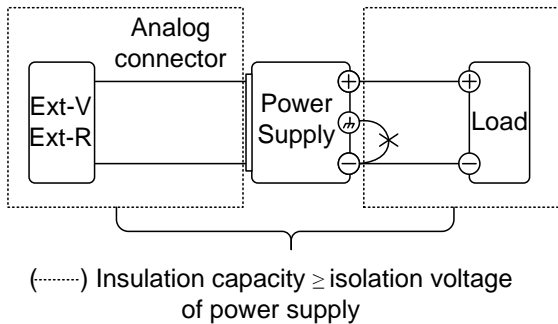

### WARNING

If the insulation capacity of the load and load cables is not greater than the isolation voltage of the power supply, electric shock may occur.

Grounded output terminal

If the positive or negative terminal is connected to the protective ground terminal, the insulation capacity needed for the load and load cables is greatly reduced. The insulation capacity only needs to be greater than the maximum output voltage of the power supply with respect to ground.

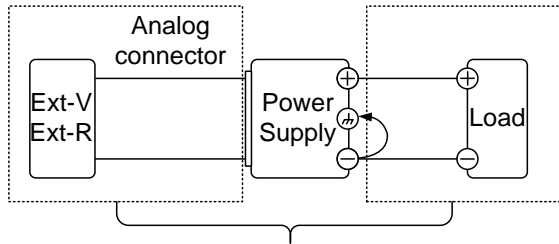

(-----) Insulation capacity  $\geq$  voltage of power supply with respect to ground

 CAUTION

If using external voltage control, do not ground the external voltage terminal as this will create a short circuit.



# O PERATION

<b>Set Up .....</b>	<b>31</b>
Filter Installation.....	31
Power Up.....	32
Wire Gauge Considerations.....	33
Output Terminals .....	34
Using the Output Terminal Cover .....	36
Using the Rack Mount Kit .....	37
How to Use the Instrument .....	38
Reset to Factory Default Settings .....	40
View System Version and Build Date.....	41
<b>Basic Operation.....</b>	<b>43</b>
Setting OVP/OCP Levels .....	43
Set to CV Mode .....	45
Set to CC Mode.....	48
Display Modes.....	51
Panel Lock .....	52
Remote Sense .....	53
<b>Parallel / Series Operation .....</b>	<b>56</b>
Master-Slave Parallel Overview.....	57
Master-Slave Parallel Connection .....	60
Master-Slave Parallel Operation.....	62
Master-Slave Series Overview .....	65
Master-Slave Series Connection.....	67
Master-Slave Series Operation .....	68

## Set Up

### Filter Installation

---

**Background**            The 2260B has a small filter that must first be inserted under the control panel before operation. The small filter must be inserted for all model types (360W models/720W models).

---

- Steps**
1. Insert the small filter in the open area under the control panel.
  2. The unit is now ready to power up.

---

## Power Up

---

### Steps

1. Connect the power cord to the rear panel socket.

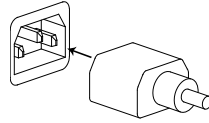

2. Press the POWER key. If used for the first time, the default settings will appear on the display, otherwise The 2260B recovers the state right before the power was last turned OFF.

For default configuration settings, see page 136.

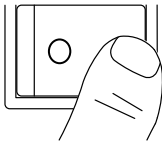

### CAUTION

The power supply takes around 8 seconds to fully turn on and shutdown.

Do not turn the power on and off quickly. Please wait for the display to fully turn off.

## Wire Gauge Considerations

### Background

Before connecting the output terminals to a load, the wire gauge of the cables should be considered.

It is essential that the current capacity of the load cables is adequate. The rating of the cables must equal or exceed the maximum current rated output of the instrument.

### Recommended wire gauge

Wire Gauge	Maximum Current
20	2.5A
18	4A
16	6A
14	10A
12	16A
10	21A
8	36A
6	61A
4	97A

## Output Terminals

**Background** Before connecting the output terminals to the load, first consider whether voltage sense will be used, the gauge of the cable wiring and the withstand voltage of the cables and load.

The output terminals can be connected to load cables using M4 sized screws or M8 sized bolts.



### WARNING

Dangerous voltages. Ensure that the power to the instrument is disabled before handling the power supply output terminals. Failing to do so may lead to electric shock.

### Steps

1. Turn the power switch off.

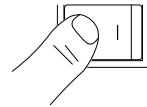

2. Remove the output terminal cover. [Page 36](#)

3. If necessary, screw the chassis ground terminal to either the positive or negative terminal. See [Page 28](#) the grounding chapter for details.

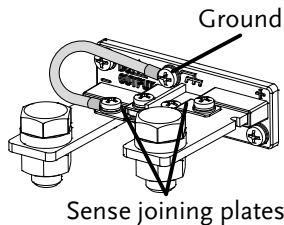

4. Choose a suitable wire gauge for the load cables. [Page 33](#)

5. Choose a suitable crimp for the terminals.
6. If using voltage sense, remove the Page 53 sense terminal joining plates and connect sensing wires to the load(s).
7. Connect the positive load cable to the positive output terminal and the negative cable to the negative output terminal.
8. Reattach the output terminal Page 36 cover.

Connection without sense wiring

Using M4 screws

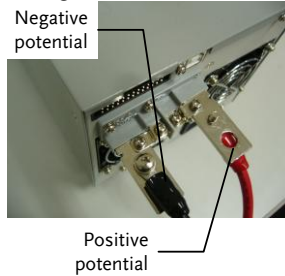

Using M8 bolts

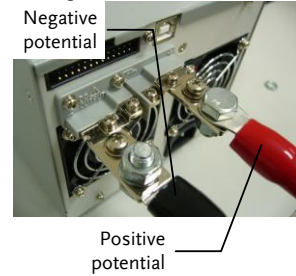

Connection with sense wiring

Using M4 screws

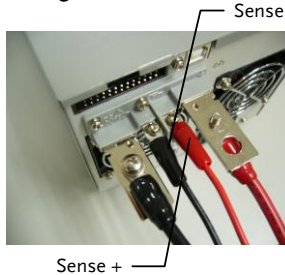

Using M8 bolts

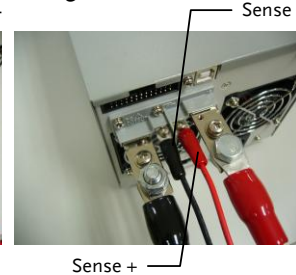

## Using the Output Terminal Cover

- Steps
1. Remove the screw holding the top cover to the bottom cover.
  2. Line-up the bottom cover with the notches in the output terminals.
  3. Place the top terminal cover over the bottom cover.

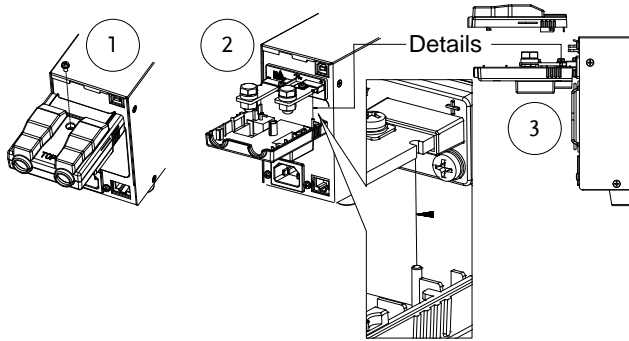

4. Use your thumb to slide the terminal covers shut, as shown in the diagram below.
5. When the top and bottom covers are flush, re-insert the screw that was removed in step 1.

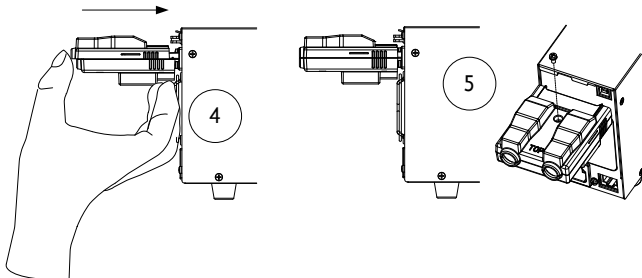

Removal                    Reverse the procedure to remove the terminal covers.

## Using the Rack Mount Kit

Background                The 2260B series has an optional Rack Mount Kit that can be used to hold 6x 360W models, 3x 360W models or a combination of all models.

Rack mount  
example

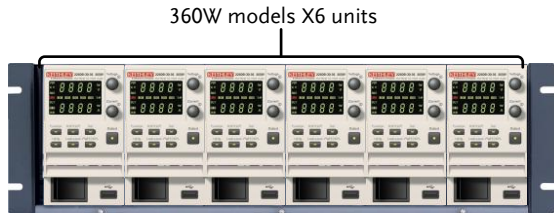



## How to Use the Instrument

### Background

The 2260B power supplies use a novel method of configuring parameter values only using the Voltage or Current knobs. The knobs are used to quickly edit parameter values at 0.01, 0.1 or 1 unit steps at a time.

When the user manual says to set a value or parameter, use the steps below.

### Example

Use the Voltage knob to set a voltage of 10.05 volts.

6. Repeatedly press the Voltage knob until the last digit is highlighted. This will allow the voltage to be edited in 0.01 volt steps.
7. Turn the Voltage knob till 0.05 volts is shown.

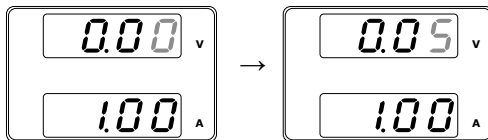
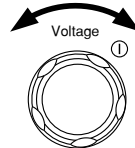
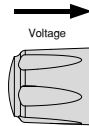

8. Repeatedly press the Voltage knob until the first digit is highlighted. This will allow the voltage to be edited in 1 volt steps.
9. Turn the Voltage knob until 10.05 is shown.

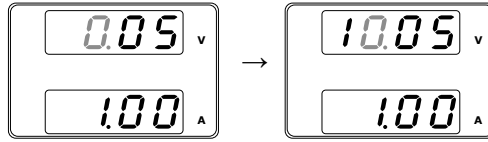





Notice the Set key becomes illuminated when setting the current or voltage.

If the Voltage or Current knobs are unresponsive, press the Set key first.

## Reset to Factory Default Settings

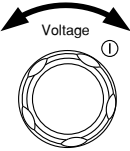
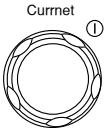
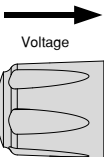
**Background** The F-88 configuration setting allows the 2260B to be reset back to the factory default settings. See page 136 for the default factory settings.

- Steps**
- Press the Function key. The Function key will light up.
 
  - The display should show F-01 on the top and the configuration setting for F-01 on the bottom.
 
  - Rotate the Voltage knob to change the F setting to F-88 (Factory Set Value).
 
  - Use the Current knob to set the F-88 setting to 1 (Return to factory settings).
 
  - Press the Voltage knob to confirm. ConF will be displayed when successful.
 
  

  - Press the Function key again to exit. The function key light will turn off.
 

## View System Version and Build Date

**Background** The F-89 configuration setting allows you to view the 2260B version number, build date, keyboard version, analog-control version and kernel build.

### Steps

1. Press the Function key. The Function key will light up.



2. The display should show F-01 on the top and the configuration setting for F-01 on the bottom.



3. Rotate the Voltage knob to change the F setting to F-89 (Show Version).
4. Rotate the Current knob to view the version and build date for the various items.

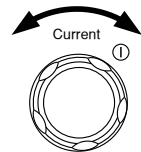

**F-89**

- 0-XX: Main Program Version
- 1-XX: Main Program Version
- 2-XX: Main Program Build On-Year.
- 3-XX: Main Program Build On-Year.
- 4-XX: Main Program Build On-Month.
- 5-XX: Main Program Build On-Day.
- 6-XX: Keyboard CPLD version.
- 7-XX: Keyboard CPLD version.
- 8-XX: Analog CPLD version.
- 9-XX: Analog CPLD version.
- A-XX: Reserved.
- B-XX: Reserved.
- C-XX: Kernel Build On-Year.
- D-XX: Kernel Build On-Year.

E-XX: Kernel Build On-Month.

F-XX: Kernel Build On-Day.

5. Press the Function key again to exit. The function key light will turn off.

Function



---

Example                    Main Program Version: V01.09, 2011/08-01

0-01: Main Program Version

1-09: Main Program Version

2-20: Main Program Build On-Year.

3-11: Main Program Build On-Year.

4-08: Main Program Build On-Month.

5-01: Main Program Build On-Day.

---

Example                    Keyboard CPLD Version: 0x030c

6-03: Keyboard CPLD Version.

7-0c: Keyboard CPLD Version.

---

Example                    Analog CPLD Version: 0x0421

8-04: Analog CPLD Version.

9-21: Analog CPLD Version.

---

Example                    Kernel Version: 2011/05/22

C-20: Kernel Build On-Year.

D-11: Kernel Build On-Year.

E-05: Kernel Build On-Month.

F-22: Kernel Build On-Day.

---

## Basic Operation

This section describes the basic operations required to operate the power supply.

- Setting OVP/OCP → from page 43
- CV mode → from page 45
- CC mode → from page 48
- Display modes → page 51
- Panel lock → page 52
- Remote sensing → from page 53

Before operating the power supply, please see the Getting Started chapter, page 7.

### Setting OVP/OCP Levels

---

The OVP level has a selectable range of 10% to 110% of the rated output voltage. The OCP level has a selectable range 10%~ 110% of the rated output current, alternatively the OCP level can also be turned off. The OVP and OCP level is set to 110% by default.

When one of the protection measures are on, ALM is shown on the panel display. By default, the power switch will turn off when any of the protection levels are tripped.



Before setting the OVP or OCP level:

- Ensure the load is not connected.
- Ensure the output is set to off.

Steps

1. Press the OVP/OCP key. The OVP/OCP key lights up.

OVP/OCP



2. The OVP setting will be displayed on the top and the OCP setting (or OFF) will be displayed on the bottom.

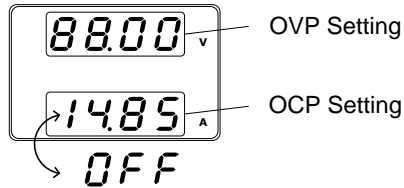

OVP Level

3. Use the Voltage knob to set the OVP level.

Range 10%~110% of rated output voltage.

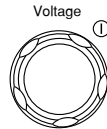

OCP Level

4. Use the Current knob to set the OCP level.

Range 10%~110% of rated output current, OFF.

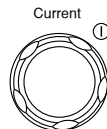

5. Press OVP/OCP again to exit. The OVP/OCP indicator will turn off.

OVP/OCP



Power switch trip

Set F-95 (Power switch trip) to 1 (to disable the power switch trip) or to 0 (to enable the power switch trip) and save.

Page 96



F-95 1 (Disable) or 0 (Enable)

Clear OVP/OCP protection	The OVP or OCP protection can be cleared after it has been tripped by holding the OVP/OCP button for 2 seconds. (Only applicable when the power switch trip setting is disabled [F-95 = 1])	 OVP/OCP (hold)
--------------------------	------------------------------------------------------------------------------------------------------------------------------------------------------------------------------------------------	--------------------------------------------------------------------------------------------------------

## Set to CV Mode

When setting the power supply to constant voltage mode, a current limit must also be set to determine the crossover point. When the current exceeds the crossover point, the mode switches to CC mode. For details about CV operation, see page 18. CC and CV mode have two selectable slew rates: High Speed Priority and Slew Rate Priority. High Speed Priority will use the fastest slew rate for the instrument while Slew Rate Priority will use a user-configured slew rate.

Background	Before setting the power supply to CV mode, ensure: <ul style="list-style-type: none"> <li>• The output is off.</li> <li>• The load is connected.</li> </ul>
------------	--------------------------------------------------------------------------------------------------------------------------------------------------------------

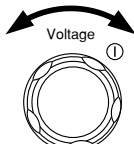
Steps	<ol style="list-style-type: none"> <li>1. Press the Function key. The Function key will light up.</li> </ol>	 Function
	<ol style="list-style-type: none"> <li>2. The display should show F-01 on the top and the configuration setting for F-01 on the bottom.</li> </ol>	
	<ol style="list-style-type: none"> <li>3. Rotate the Voltage knob to change the F setting to F-03 (V-I Mode Slew Rate Select).</li> </ol>	



- Use the Current knob to set the F-03 setting.

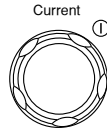

Set F-03 to 0 (CV High Speed Priority) or 2 (CV Slew Rate Priority).

F-03            0 = CV High Speed Priority  
                   2 = CV Slew Rate Priority

- Press the Voltage knob to save the configuration setting. Conf will be displayed when successful.

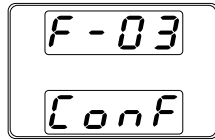
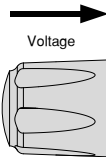

- If CV Slew Rate Priority was chosen as the operating mode in steps 3~5, set F-04 (Rising Voltage Slew Rate) and F-05 (Falling Voltage Slew Rate) and save.

F-04 / F-05 0.1V/s~60V/s (2260B-30-XX)  
                   0.1V/s~160V/s (2260B-80-XX)

- Press the Function key again to exit the configuration settings. The function key light will turn off.



- Use the Current knob to set the current limit (crossover point). Push in the knob to highlight a digit. Turn the knob to the desired digit to adjust. Rotate the knob to the desired current.

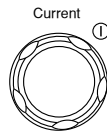

9. Use the Voltage knob to set the voltage.  
Push in the knob to highlight a digit. Turn the knob to the desired digit to adjust. Rotate the knob to the desired voltage.

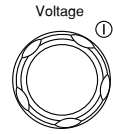

Note

Notice the Set key becomes illuminated when setting the current or voltage. If the Voltage or Current knobs are unresponsive, press the Set key first.

10. Press the Output key. The Output key becomes illuminated.



CV and the Power Bar will become illuminated (top left & center)



Note

Only the voltage level can be altered when the output is on. The current level can only be changed by pressing the Set key.

## Set to CC Mode

When setting the power supply to constant current mode, a voltage limit must also be set to determine the crossover point. When the voltage exceeds the crossover point, the mode switches to CV mode. For details about CC operation, see page 18. CC and CV mode have two selectable slew rates: High Speed Priority and Slew Rate Priority. High Speed Priority will use the fastest slew rate for the instrument while Slew Rate Priority will use a user-configured slew rate.

**Background** Before setting the power supply to CC mode, ensure:

- The output is off.
- The load is connected.

### Steps

1. Press the Function key. The Function key will light up.

Function



2. The display should show F-01 on the top and the configuration setting for F-01 on the bottom.



3. Rotate the Voltage knob to change the F setting to F-03 (V-I Mode Slew Rate Select).

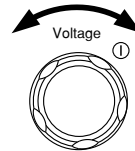

4. Use the Current knob to set the F-03 setting.

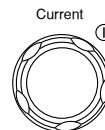

Set F-03 to 1 (CC High Speed Priority) or 3 (CC Slew Rate Priority) and save.

F-03      1 = CC High Speed Priority  
              3 = CC Slew Rate Priority

5. Press the Voltage knob to save the configuration setting. ConF will be displayed when successful.

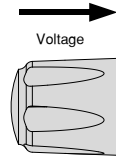

6. If CC Slew Rate Priority was chosen as the operating mode, set F-06 (Rising Current Slew Rate) and F-07 (Falling Current Slew Rate) and save.

F-06 / F-07   0.01A/s~72.00A/s (2260B-30-36)  
                   0.01A/s~144.0A/s (2260B-30-72)  
                   0.01A/s~27.00A/s (2260B-80-13)  
                   0.01A/s~54.00A/s (2260B-80-27)

7. Press the Function key again to exit the configuration settings. The function key light will turn off.



8. Use the Voltage knob to set the voltage limit (crossover point). Push in the knob to highlight a digit. Turn the knob to the desired digit to adjust. Rotate the knob to the desired voltage.

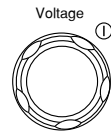

9. Use the Current knob to set the current. Push in the knob to highlight a digit. Turn the knob to the desired digit to adjust. Rotate the knob to the desired current.

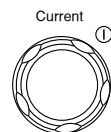



Note

Notice the Set key becomes illuminated when setting the current or voltage. If the Voltage or Current knobs are unresponsive, press the Set key first.

10. Press the Output key. The Output key becomes illuminated.

Output

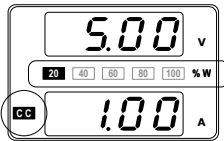

CC and the Power Bar will become illuminated (bottom left & center)



Note

Only the current level can be altered when the output is on. The voltage level can only be changed by pressing the Set key.

## Display Modes

The 2260B power supplies allow you to view the output in three different modes: voltage and current, voltage and power or current and power.

- |       |                                                                                                                                                        |                                                                                               |
|-------|--------------------------------------------------------------------------------------------------------------------------------------------------------|-----------------------------------------------------------------------------------------------|
| Steps | <ol style="list-style-type: none"> <li>1. Press the PWR/DSPL key. The PWR DSPL key lights up.</li> </ol>                                               | PWR DSPL<br> |
|       | <ol style="list-style-type: none"> <li>2. The display changes to voltage and power (V/W).</li> </ol>                                                   |                                                                                               |
|       | <ol style="list-style-type: none"> <li>3. To switch between displaying A/W and V/W, simply press the corresponding Voltage or Current knob.</li> </ol> |                                                                                               |

For example: when in A/W mode, press the Voltage knob to display V/W. Conversely when in V/W mode, press the Current knob to display A/W.

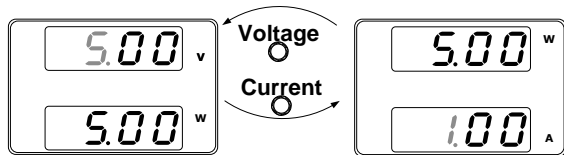

- When V/W is displayed, the Voltage knob can still be used to change the voltage level.
- When A/W is displayed, the Current knob can still be used to change the current level.



- |      |                                                                                                         |                                                                                                 |
|------|---------------------------------------------------------------------------------------------------------|-------------------------------------------------------------------------------------------------|
| Exit | <p>Press the PWR/DSPL key again to return to normal display mode. The PWR DSPL light will turn off.</p> | PWR DSPL<br> |
|------|---------------------------------------------------------------------------------------------------------|-------------------------------------------------------------------------------------------------|

## Panel Lock

The panel lock feature prevents settings from being changed accidentally. When activated, the Lock/Local key will become illuminated and all keys and knobs except the Lock/Local key and Output key (if active) will be disabled.

If the instrument is remotely controlled via the USB/LAN interface, the panel lock is automatically enabled.

---

Activate the panel lock	Press the Lock/Local key to activate the panel lock. The key will become illuminated.	Lock/Local 
Disable the panel lock	Hold the Lock/Local key for ~3 seconds to disable the panel lock. The Lock/Local light turns off.	Lock/Local 

---

## Remote Sense

Remote sense is used to compensate for the voltage drop seen across load cables due to the resistance inherent in the load cables. The remote sense terminals are connected to the load terminals to determine the voltage drop across the load cables.

Remote sense can compensate up to 0.6 volts (compensation voltage). Load cables should be chosen with a voltage drop less than the compensation voltage.



### WARNING

Ensure the output is off before connecting any sense cables.

Use sense cables with a voltage rating exceeding the isolation voltage of the power supply.

Never connect sensing cables when the output is on. Electric shock or damage to the power supply could result.



### Note

Be sure to remove the Sense joining plates so the units are not using local sensing.

## Single Load

1. Connect the Sense+ terminal to the positive potential of the load. Connect the Sense- terminal to the negative potential of the load.

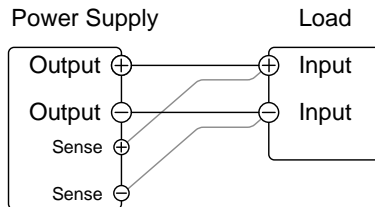

Page 34

2. Operate the instrument as normal. See the Basic Operation chapter for details.



Parallel 2260B  
Units

1. Connect the Sense+ terminals to the positive potential of the load. Connect the Sense- terminals to the negative potential of the load.

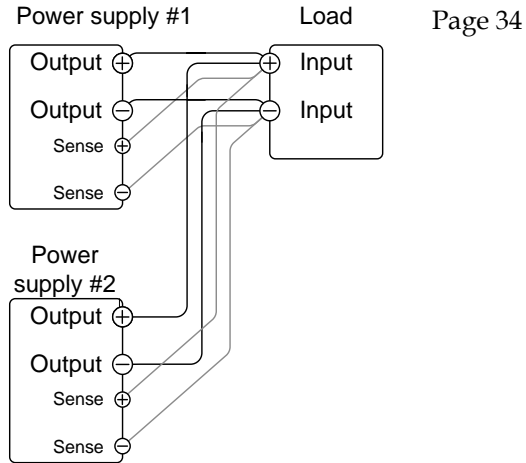

2. Operate the instrument as normal. Page 57  
See the Parallel Operation chapter for details.

Serial 2260B  
Units

1.
  - a. Connect the 1<sup>st</sup> Sense+ terminal to the positive potential of the load.
  - b. Connect the 1<sup>st</sup> Sense- terminal to the positive output terminal of the second 2260B unit.
  - c. Connect the 2<sup>nd</sup> Sense+ terminal to the positive terminal of the second 2260B unit.
  - d. Connect the 2<sup>nd</sup> Sense- terminal to negative terminal of the load.

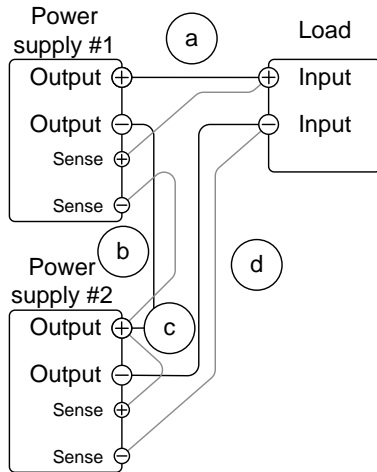

2. Operate the instrument as normal. Page 65  
See the Serial Operation chapter for details.

Wire Shielding and Load line impedance

To help to minimize the oscillation due to the inductance and capacitance of the load cables, use an electrolytic capacitor in parallel with the load terminals.

To minimize the effect of load line impedance use twisted wire pairing.

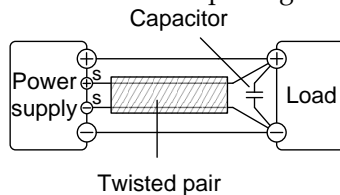

## Parallel / Series Operation

This section describes the basic operations required to operate the power supply in series or parallel. Operating the 2260B power supplies in parallel increases the total power output of the power supply units. When used in series, the total output voltage of the power supplies can be increased.

The number of the power supplies that can be connected in series or parallel depends on the model and the mode:

- Series Mode: 2 units maximum
- Parallel Mode: 3 units maximum

To use the power supplies in series or parallel, units must be used in a Master-Slave configuration. In the master-slave configuration a “master” power supply controls any other connected “slave” power supplies.

- Master-Slave Parallel overview → from page 57
- Parallel connection → from page 60
- Parallel operation → from page 62
- Master-Slave Series overview → page 65
- Series connection → page 67
- Series operation → from page 68

Before operating the power supply, please see the Getting Started chapter, page 7.

---

## Master-Slave Parallel Overview

---

### Background

When connecting the 2260B power supplies in parallel, up to 3 units can be used in parallel and all units must be of the same model.

When the units are used in parallel, a number of precautions and limitations apply. Please read this overview before operating the power supplies in parallel.

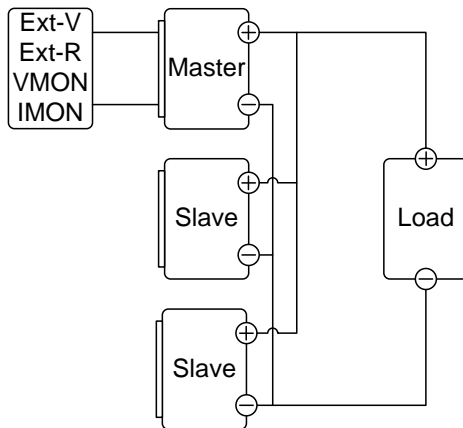

---

### Limitations

#### Display

- Only the master unit will display the voltage and current.

### OVP/ OCP

- The master unit can shut down slave units when OVP/OCP is tripped on the master unit (if the slave connector is wired for shut down on alarm).
- OVP/OCP can be independently tripped on each slave unit, however the shutdown of the power or output of the unit is disabled. Only the alarm will be enabled.

### Remote monitoring

- Voltage monitoring (VMON) and current monitoring (IMON) are only supported on the master unit.
- The IMON current represents the total current of the all the parallelized units.

### Remote Sense

- Please see the remote sense chapter for details, page 53.

### External Voltage and Resistance Control

- Voltage/Resistance controlled remote control can only be used with the master unit.

### Slew Rate

- Only the master unit's current or voltage slew rate settings apply.
- The *settable current* slew rate is double or triple that of a single unit, depending on the number of units that are used in parallel.

For example:

The 2260B-30-36 has a maximum settable current slew rate of 72A/S. When two 2260-30-36 units are used in parallel, the maximum settable slew rate setting is 144A/S.

### Internal Resistance

- Only the master unit's internal resistance settings apply.
- For 2 units in parallel, the internal resistance is actually half of the setting value.
- For 3 units in parallel, the internal resistance is actually a third of the setting value.

### Bleeder Control

- The master unit is used to control the bleeder settings. The bleeder resistors in all the slave units are always turned off when in parallel mode.

	Model	Single unit	2 units	3 units
Output Voltage/ Output Current	2260B-30-36	30V	30V	30V
		36A	72A	108A
	2260B-80-13	80V	80V	80V
		13.5A	27A	40.5A
	2260B-30-72	30V	30V	30V
		72A	144A	216A
	2260B-80-27	80V	80V	80V
		27A	54A	81A

## Master-Slave Parallel Connection

**Master-Slave Connector**      The Analog Control Connector is used for both serial and parallel connections. The way the connector is configured determines the behavior of the master and slave units. For the complete connector pin assignment, see page 99.

**Analog Connector Connection**      To operate the power supplies in parallel, connect the analog connectors on the master and slave units as shown in the diagrams below.

Master with 2 slave units:

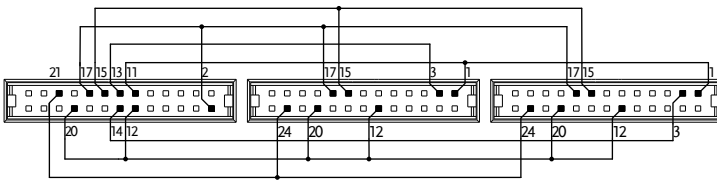

Master unit	Slave Unit 1	Slave Unit 2
11 1 MON	1 CURRENT SHARE	1 CURRENT SHARE
21 OUTPUT ON STATUS	24 OUT ON/OFF CONT	24 OUT ON/OFF CONT
20 ALM STATUS	12 SHUTDOWN	12 SHUTDOWN
17 STATUS COM	17 STATUS COM	17 STATUS COM
15 FEEDBACK	15 FEEDBACK	15 FEEDBACK
14 CURRENT_SUM_2	3 CURRENT SUM OUT	3 CURRENT SUM OUT
13 CURRENT_SUM_1	20 ALM STATUS	20 ALM STATUS
12 SHUTDOWN		
2 D COM		

Master with 1 slave unit:

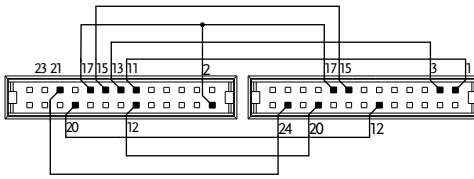

Master unit		Slave Unit 1	
11	I MON	1	CURRENT SHARE
21	OUTPUT ON STATUS	24	OUT ON/OFF CONT
20	ALM STATUS	12	SHUTDOWN
17	STATUS COM	17	STATUS COM
15	FEEDBACK	15	FEEDBACK
13	CURRENT_SUM_1	3	CURRENT SUM OUT
12	SHUTDOWN	20	ALM STATUS
2	D.COM		

Parallel Output Connection

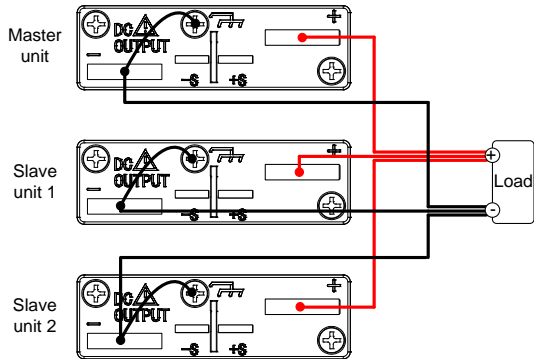

Steps

1. Ensure the power is off on all power supplies.
2. Choose a master and a slave unit(s).
3. Connect the analog connectors for the master and slave unit as shown above.
4. Remove the Output Terminal covers and the protection dummy plug from the analog control connector.



5. Connect the master and slave unit in parallel as shown above.

6. Reattach the terminal covers. Page 36



Note

Ensure the load cables have sufficient Page 33  
current capacity.

Re-attach the protection dummy plug when not in use.

## Master-Slave Parallel Operation

Master-Slave Configuration      Before using the power supplies in parallel, the master and slave units need to be configured.

Steps      1. Configure the OVP and OCP settings for the master unit. Page 43

2. For each unit, hold the Function key while turning the power on to enter the power on configuration settings.

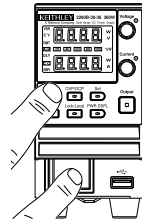

3. Configure F-93 (Master/Slave) setting for each master/slave unit. Page 96

Unit	F-93
Master (with 1 slave in parallel)	1
Master (with 2 slaves in parallel)	2
Slave unit (parallel slave)	3

4. Cycle the power on the units (reset the power).



Note

Configuration settings can be checked for both the master and slave units by pressing the Function key and checking F-93.

Only the Master OVP and OCP level is used for over voltage and current protection. Slave OVP and OCP level is disregarded.

OTP works independently for each unit.

### Master-Slave Operation

Only operate the power supplies in parallel if the units are configured correctly.

1. Turn on the master and slave units. The slave unit(s) will show a blank display.

Master unit



Slave units

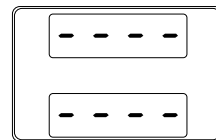

2. Operation of all units is controlled via the master unit. Operation of the master unit is the same as for a single unit. See the Basic Operation chapter. Page 40.

3. Press the Output key to begin.

Output



Caution

Only operate the power supplies in parallel if using units of the same model number.

Only a maximum can be used in parallel.



Note

The panel controls are disabled on slave units, including the output key. On slave units only the Function key can be used to view the current settings.

---

## Master-Slave Series Overview

---

### Background

When connecting 2260B power supplies in series, up to 2 units can be used in series and all units must be of the same model.

When the units are used in series, a number of precautions and limitations apply. Please read this overview before operating the power supplies in series.

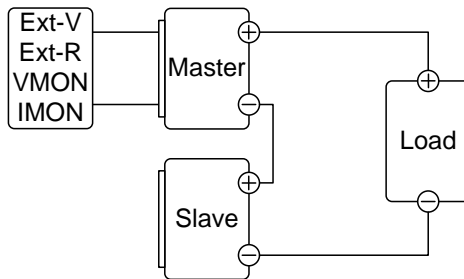

---

### Limitations

#### Display

- Only the master unit will display the current.
- Master and slave units display the voltage. The total voltage is the sum of the units.

#### OVP/OCP

- The master unit can shut down the slave unit when OVP/OCP is tripped on the master unit (if the slave connector is wired for shut down on alarm).
- OVP and OCP level is determined by the master OVP and OCP level. The OVP and OCP level on the slave unit is ignored.

#### Remote monitoring

- Voltage monitoring (VMON) and current monitoring (IMON) are only supported on the master unit.
- The VMON voltage represents the total voltage of the all the serialized units.

#### Remote Sense

- Please see the remote sense chapter for details, page 53.

#### External Voltage and Resistance Control

- Voltage/Resistance controlled remote control can only be used with the master unit.

#### Slew Rate

- The voltage slew rate is actually double that of the setting slew rate. I.e., A voltage slew rate setting of 60.00V/s is actually 120V/s when in series.

#### Internal Resistance

- Only the master unit's internal resistance settings apply.
- The internal resistance is actually twice that of the setting value.

#### Bleeder Control

- The Master unit is used to control the bleeder settings. The bleeder resistor is always turned on for the slave unit in series mode.

	Model	Single unit	2 units
Output Voltage/ Output Current	2260B-30-36	30V	60V
		36A	36A
	2260B-80-13	80V	160V
		13.5	13.5A
	2260B-30-72	30V	60V
		72A	72A
	2260B-80-27	80V	160V
		27A	27A

## Master-Slave Series Connection

### Master-Slave Connector

The Analog Control Connector is used for both serial and parallel connections. The way the connector is configured determines the behavior of the master and slave units. For the connector pin assignment, see page 99.

### Analog Connector Connection

To operate the power supplies in series, connect the analog connectors on the master and slave unit as shown in the diagram below.

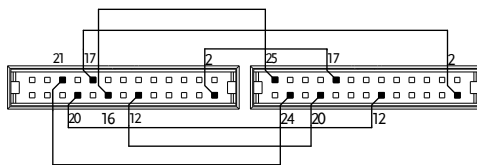

Master unit		Slave Unit 1	
16	A COM	25	SER SLV IN
21	OUTPUT ON STATUS	24	OUT OFF/ON CONT
20	ALM STATUS	12	SHUTDOWN
17	STATUS COM	2	D COM
12	SHUTDOWN	20	ALM STATUS
2	D COM	17	STATUS COM

## Series Output Connection

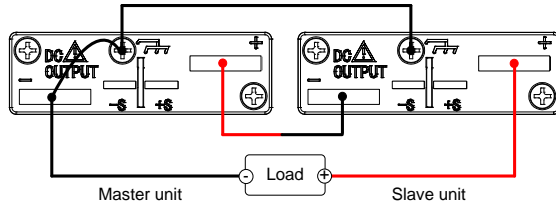

- Steps
1. Ensure the power is off on both power supplies.
  2. Choose a master and slave unit.
  3. Connect the analog connectors for the master and slave unit as shown above.
  4. Remove the output terminal cover [Page 36](#) and the protection dummy plug from the analog control connector.
  5. Connect the master and slave unit in series as shown above.
  6. Reattach the terminal cover. [Page 36](#)



Note

Ensure load cables have sufficient [Page 33](#) current capacity.

Re-attach the protection dummy plug when not in use.

## Master-Slave Series Operation

Master-Slave Configuration Before using the power supplies in series, the master and slave units need to be configured.

1. Configure the OVP and OCP [Page 43](#) settings for the master unit.

- For each unit, hold the Function key while turning the power on to enter the power on configuration settings.

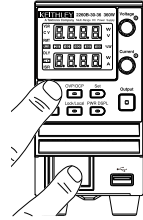

- Configure F-93 (Master/Slave) setting for each master/slave unit. Page 96

Unit	F-93
Master (local or series operation)	0
Slave unit (series)	4

- Cycle the power on the units (reset the power).



Note

Configuration settings can be checked for both the master and slave units by pressing the Function key.

### Master-Slave Operation

Only operate the power supplies in series if the units are configured correctly.

- Turn on the master and slave unit. The slave unit will only show the voltage of its own unit. The master unit will show the combined voltage of both units and the current.

Master unit



Slave unit

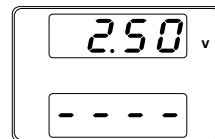



2. Operation of all units is controlled via the master unit. Operation of the master unit is the same as for a single unit. Please see the basic operation chapter for details. Page 40
3. Press the Output key to begin.



Only operate the power supplies in series if using units of the same model number.

---

Only a maximum of 2 units can be used in series.



The panel controls are disabled on slave units, including the output key.

## Test Sequence

This section describes how to use the Utility function to run, load and save test sequences for automated testing. The Utility function is useful if you want to perform a number of tests automatically. The 2260B utility function can store ten test sequences in memory.

- Test Sequence File Format → from page 72
- Test Sequence Settings → from page 75
- Setting the Test Sequence Settings → from page 76
- Load Test Sequence → from page 77
- Run Test Sequence → from page 78
- Export Test Sequence → from page 79
- Remove Test Sequence → from page 80
- Test Sequence Error Codes → from page 81

## Test Sequence File Format

A test sequence file describes a sequence of steps that are output when the test sequence is run. The test sequence file is created on a PC in a \*.CSV (comma separated values) format. In a CSV file each field is delimited by a comma.

Each file should be saved as tXXX.csv, where XXX is the save file number 001~010. The save file number is important as it designates which memory slot the test file can be loaded into, see page 77.

Below is an example of a simple test file created in a spreadsheet.

	A	B	C	D
1	1	2	3	5
2	Step	Time(sec)	Voltage (V)	Current (A)
3	1	1	MIN	MIN
4	4	1	0.15	0.15
5	5	1	0.2	0.2
6	6	1	0.25	0.25
7	7	1	0.3	0.3
8	8	1	0.35	0.35

A test file contains the following fields in the following order:

Line 1:

**Cycle Header:** This field contains the “Cycle” header text. Required. Do not remove or alter from this location.

**Cycle Repeat:** Determines the number of times to repeat a sequence of steps. It has a range of 1~999 or 0 | INF. A setting of 1 will pass through the cycle once. A setting of 0 or INF (case insensitive) will repeat the cycle infinitely.

Cycle Step Start: Determines the starting step for the Cycle Repeat field. Range: 1~999. The Cycle Step Start field must be less than the Cycle Step End field.

Cycle Step End: Determines the ending step for the Cycle Repeat field. Range: 2~1000. The Cycle Step End field must be greater than the Cycle Step Start field.

Line 2:

Step Header: This field contains the "Step" header text. Required. Do not remove from this location.

Time(sec) Header: This field contains the "Time(sec)" header text. Required. Do not remove or alter from this location.

Voltage (V) Header: This field contains the "Voltage (V)" header text. Required. Do not remove or alter from this location.

Current (A) Header: This field contains the "Current (A)" header text. Required. Do not remove or alter from this location.

Line 3+:

Step Number: The Step Number field numbers each step in the test function. It has a range of 1~1000. All steps must be numbered in numerical order. No step number can be "skipped" between the first and last step.

Time(sec): Designates the duration time of the corresponding step in seconds. It has a range of 0.05 seconds to 20 days. It has a step resolution of 0.05 seconds (50ms). A setting of 0 will skip the step.

Voltage (V): Designates the voltage of the corresponding steps in volts. MIN or MAX can be used to set the voltage to minimum or maximum, respectively.

Current (A): Designates the current of the corresponding steps in amps. MIN or MAX can be used to set the current to minimum or maximum, respectively.

Example: In the example below there are 10 steps in total. As designated by the Cycle fields, steps 3~5 are repeated twice.

In total the steps will run as follows:

Step: 1>2>3>4>5>3>4>5>6>7>8>9>10

Steps 3~5 are repeated twice

File: T001.csv

```
Cycle,2,3,5
Step,Time(sec),Voltage (V),Current (A)
1,1,MIN,MIN
2,1,0.05,0.05
3,1,0.1,0.1
4,1,0.15,0.15
5,1,0.2,0.2
6,1,0.25,0.25
7,1,0.3,0.3
8,1,0.35,0.35
9,1,0.4,0.4
10,1,0.45,0.45
```

## Test Sequence Settings

---

Test sequence Run	Runs the chosen test sequence from the internal memory. A test sequence must first be loaded into the internal memory before it can be run. See the Utility function “Test Sequence Load”, below.
	The test sequence will run as soon as the utility function is started.
	T-01                    1~10
Test sequence Load	Loads a test sequence from the USB drive to the designated save slot in memory. A test sequence must first be loaded into internal memory before it can be run.
	T-02                    1~10 (USB→2260B)
Test Export	Exports a test sequence from the designated memory save slot to the USB drive.
	T-03                    1~10 (2260B→USB)
Test sequence Remove	Deletes the chosen test sequence file from the 2260B internal memory.
	T-04                    1~10

## Setting the Test Sequence Settings

**Steps** The test sequence settings (T-01~T-04) are set with the Utility key.

1. Press the Utility key. The Utility key will light up.



2. The display will show T-01 on the top and the memory no. for T-01 on the bottom.

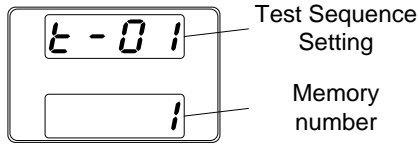

3. Rotate the voltage knob to select below items.

Test sequence Run	T-01
Test sequence Load	T-02
Test sequence Export	T-03
Test sequence Remove	T-04

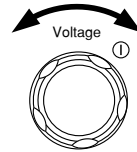

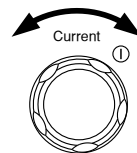

4. Rotate the current knob to choose a memory slot number.

Range 1~10

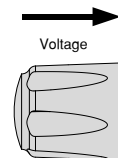

5. Press the Voltage knob to complete the setting.



Exit	Press the Utility key again to exit the Test sequence settings. The Utility key light will turn off.	Utility 
------	------------------------------------------------------------------------------------------------------	----------------------------------------------------------------------------------------------

## Load Test Sequence from USB

---

Overview	<p>Before a test sequence can be run, it must first be loaded into a one of the 10 memory save slots. Before loading a test sequence into memory:</p> <ul style="list-style-type: none"> <li>• Ensure the test sequence file is placed in the root directory.</li> <li>• Ensure the file name number corresponds to the memory number that you wish to save to.</li> </ul> <p>For example: A test sequence file named t001.csv can only be saved to memory number 01, t002.csv can only be saved to memory number 02, and so on.</p>
----------	--------------------------------------------------------------------------------------------------------------------------------------------------------------------------------------------------------------------------------------------------------------------------------------------------------------------------------------------------------------------------------------------------------------------------------------------------------------------------------------------------------------------------------------

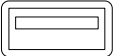
Steps	<ol style="list-style-type: none"> <li>1. Insert a USB flash drive into the front panel USB-A slot. Ensure the flash drive contains a test sequence file in the root directory.</li> <li>2. Turn on the power. MS (Mass Storage) will be displayed on the screen after a few seconds if the USB drive is recognized.</li> </ol>	 
-------	---------------------------------------------------------------------------------------------------------------------------------------------------------------------------------------------------------------------------------------------------------------------------------------------------------------------------------	---------------------------------------------------------------------------------------------------------------------------------------------------------------------------

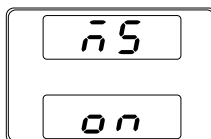





Note

If the USB drive is not recognized, check to see that the function settings for F-20 = 1 (page 90). If not, reinsert the USB flash drive.

3. Configure T-02 (Test sequence Load) to 1~10 (save memory slot) Page 76  
T-02 range 1~10 (t001 ~t010)
4. The test sequence will now be available in the memory slot the test sequence was saved to.



Note

Error messages: If you load a file that is not present on the USB drive “Err 002” will be displayed on the display.

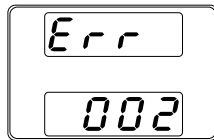

## Run Test Sequence

### Overview

A test sequence can be run from one of ten memory slots.

### Steps

1. Before a test sequence can be run, it Page 77 must first be loaded into one of the 10 memory slots.
2. Configure T-01 (Run Test sequence) to 1~10 (save memory slot) Page 76  
T-01 range 1~10
3. The test sequence will automatically start to run.



Note

Error messages: If you try to run a test sequence from an empty memory location “Err 003” will be displayed on the display.

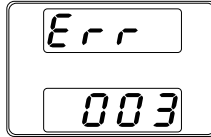

Note

When a test sequence starts to run, there is no way to abort the test sequence. Pressing the Output key has no effect. If you wish to stop a test early, turn the power off.

## Export Test Sequence to USB

### Overview

The Export test sequence function saves a test sequence file to the root directory of a USB flash drive.

- Test Sequence Files will be saved as tXXX.csv where XXX is the memory number 001~010 from which the test sequence was exported from.
- Test Sequence Files of the same name on the USB flash drive will be written over.

### Steps

1. Insert a USB flash drive into the front panel USB-A slot.

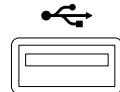

- Turn on the power. MS (Mass Storage) will be displayed on the screen after a few seconds if the USB drive is recognized.

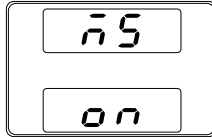

Note

If the USB drive is not recognized, check to see that the function settings for F-20 = 1 (page 90). If not, reinsert the USB flash drive.

- Configure T-03 (Test Sequence Export) from 0~10 (internal memory slot) Page 76

T-03 range 1~10

- The test sequence file will now be copied to the USB flash drive.



Note

Error messages: If you try to export a test sequence from an empty memory location “Err 003” will be displayed on the display.

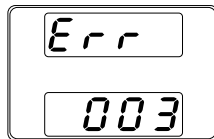

## Remove Test Sequence

Overview

The Remove Test Sequence function will delete a test sequence from the internal memory slot.

- |       |                                                                                                                                                                                                                                                             |         |
|-------|-------------------------------------------------------------------------------------------------------------------------------------------------------------------------------------------------------------------------------------------------------------|---------|
| Steps | <ol style="list-style-type: none"> <li>1. Select T-04 (Test Sequence Remove) and choose which test sequence to remove from the internal memory.<br/>T-04 range 1~10</li> <li>2. The test sequence will be removed from the internal memory slot.</li> </ol> | Page 76 |
|-------|-------------------------------------------------------------------------------------------------------------------------------------------------------------------------------------------------------------------------------------------------------------|---------|
- 



Note

Error messages: If you try to remove a test sequence from an empty memory location “Err 003” will be displayed on the display.

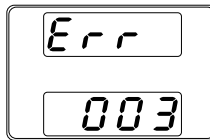

## Test Sequence Error Messages

---

**Overview** The following error code numbers may appear on the display when trying to run a test sequence. Use the error code numbers determine the cause of the error.

For example: If Error # -52 appears on the display, it indicates that one of the Time(sec) fields is over range for the test sequence.

Error #	Details
-1	_SEQ_ERR__FILE_NOT_FOUND
-2	_SEQ_ERR__FILE_IS_TOO_LARGE
-3	_SEQ_ERR__ALLOCATE_MEMORY_ERROR
-4	_SEQ_ERR__OPEN_THE_FILE_ERROR
-5	_SEQ_ERR__READ_DATA_ERROR
-6	_SEQ_ERR__USING
-7	_SEQ_ERR__FORMAT_ERROR

---

---

-8	_SEQ_ERR_PARAMETER_DATA_TO_LONG
-10	_SEQ_ERR_CYCLE_START_GREATER_THAN_CYCLE_END
-11	_SEQ_ERR_CYCLE_TIMES_ERROR
-12	_SEQ_ERR_CYCLE_TIMES_OVER_RANGE
-13	_SEQ_ERR_NO_CYCLE_TIMES
-14	_SEQ_ERR_CYCLE_START_ERROR
-15	_SEQ_ERR_CYCLE_START_OVER_RANGE
-16	_SEQ_ERR_NO_CYCLE_START
-17	_SEQ_ERR_CYCLE_END_ERROR
-18	_SEQ_ERR_CYCLE_END_OVER_RANGE
-19	_SEQ_ERR_NO_CYCLE_END
-20	_SEQ_ERR_STEP_DATA_ERROR
-21	_SEQ_ERR_STEP_DATA_OVER_RANGE
-22	_SEQ_ERR_NO_STEP_DATA
-30	_SEQ_ERR_POINT_DATA_ERROR
-31	_SEQ_ERR_START_POINT_GREATER_THAN_END_POINT
-32	_SEQ_ERR_START_POINT_REPEAT
-33	_SEQ_ERR_END_POINT_REPEAT
-40	_SEQ_ERR_OUTPUT_DATA_ERROR
-50	_SEQ_ERR_TIME_DATA_ERROR
-51	_SEQ_ERR_NEGATIVE_TIME
-52	_SEQ_ERR_TIME_OVER_RANGE
-60	_SEQ_ERR_VOLTAGE_DATA_ERROR
-61	_SEQ_ERR_NEGATIVE_VOLTAGE
-62	_SEQ_ERR_VOLTAGE_TOO_LARGE
-63	_SEQ_ERR_VOLTAGE_TOO_SMALL
-70	_SEQ_ERR_CURRENT_DATA_ERROR
-71	_SEQ_ERR_NEGATIVE_CURRENT
-72	_SEQ_ERR_CURRENT_TOO_LARGE
-73	_SEQ_ERR_CURRENT_TOO_SMALL

---

# CONFIGURATION

---

Configuration .....	84
Configuration Table .....	84
Normal Function Settings .....	87
USB/GPIB Settings .....	90
LAN Settings .....	91
System Settings .....	92
Power On Configuration Settings .....	93
Calibration.....	94

## Configuration

Configuration of the 2260B power supplies is divided into five different configuration settings: Normal Function, USB/GPIB, LAN, Power ON Configuration, Calibration Settings and System Settings. Power ON Configuration differs from the other settings in that the settings used with Power ON Configuration settings can only be set during power up. The other configuration settings can be changed when the unit is already on. This prevents some important configuration parameters from being changed inadvertently. Power On Configuration settings are numbered F-90 to F-95 and the other configuration settings are numbered F-00 to F-61 and F-88 to F-89.

### Configuration Table

Please use the configuration settings listed below when applying the configuration settings.

Normal Function Settings		
Settings	Setting	Setting Range
Output ON delay time	F-01	0.00s~99.99s
Output OFF delay time	F-02	0.00s~99.99s
V-I mode slew rate select	F-03	0 = CV high speed priority 1 = CC high speed priority 2 = CV slew rate priority 3 = CC slew rate priority
Rising voltage slew rate	F-04	0.01V/s~60.00V/s (2260B-30-XX) 0.1V/s~160.0V/s (2260B-80-XX)
Falling voltage slew rate	F-05	0.01V/s~60.00V/s (2260B-30-XX) 0.1V/s~160.0V/s (2260B-80-XX)
Rising current slew rate	F-06	0.01A/s~72.00A/s (2260B-30-36) 0.1A/s~144.0A/s (2260B-30-72) 0.01A/s~27.00A/s (2260B-80-13) 0.01A/s~54.00A/s (2260B-80-27)
Falling current slew rate	F-07	0.01A/s~72.00A/s (2260B-30-36) 0.1A/s~144.0A/s (2260B-30-72) 0.01A/s~27.00A/s (2260B-80-13) 0.01A/s~54.00A/s (2260B-80-27)

Internal resistance setting	F-08	0.000Ω~0.833Ω (2260B-30-36) 0.000Ω~0.417Ω (2260B-30-72) 0.000Ω~5.926Ω (2260B-80-13) 0.000Ω~2.963Ω (2260B-80-27)
Bleeder circuit control	F-09	0 = OFF, 1 = ON
Buzzer ON/OFF control	F-10	0 = ON, 1 = OFF
USB/GPIB settings		
Front panel USB State	F-20	0 = Absent, 1 = Mass Storage
Rear panel USB State	F-21	0 = Absent, 2 = USB-CDC, 3 = GPIB-USB adapter
Rear panel USB mode	F-22	0 = Disable, 1 = GPIB-USB adapter, 2 = USB CDC
GPIB address	F-23	0~30
LAN settings		
MAC Address-1	F-30	0x00~0xFF
MAC Address-2	F-31	0x00~0xFF
MAC Address-3	F-32	0x00~0xFF
MAC Address-4	F-33	0x00~0xFF
MAC Address-5	F-34	0x00~0xFF
MAC Address-6	F-35	0x00~0xFF
LAN	F-36	0 = Disable, 1 = Enable
DHCP	F-37	0 = Disable, 1 = Enable
IP Address-1	F-39	0~255
IP Address-2	F-40	0~255
IP Address-3	F-41	0~255
IP Address-4	F-42	0~255
Subnet Mask-1	F-43	0~255
Subnet Mask-2	F-44	0~255
Subnet Mask-3	F-45	0~255
Subnet Mask-4	F-46	0~255
Gateway-1	F-47	0~255
Gateway-2	F-48	0~255
Gateway-3	F-49	0~255
Gateway-4	F-50	0~255
DNS address -1	F-51	0~255
DNS address -2	F-52	0~255
DNS address-3	F-53	0~255
DNS address-4	F-54	0~255
Sockets active	F-57	0 = Disable, 1 = Enable
Web Server active	F-59	0 = Disable, 1 = Enable



Web password active	F-60	0 = Disable, 1 = Enable
Web setting password	F-61	0000~9999
<b>System Settings</b>		
Factory Set Value	F-88	0 = Disable 1 = Return to factory settings
Show Version	F-89	0, 1 = Version 2, 3 = Build year 4, 5 = Build month/day 6, 7 = Keyboard CPLD version 8, 9 = Analog-Control CPLD version A, B = Reserved C, D = Kernel build year E, F = Kernel build month/day
<b>Power On Configuration Settings*</b>		
CV Control	F-90	0 = Panel control (local) 1 = External voltage control 2 = External resistance control (Ext-R $\searrow$ 10k $\Omega$ = Vo, max) 3 = External resistance control (Ext-R $\swarrow$ 10k $\Omega$ = 0)
CC Control	F-91	0 = Panel control (local) 1 = External voltage control 2 = External resistance control (Ext-R $\searrow$ 10k $\Omega$ = Io, max) 3 = External resistance control (Ext-R $\swarrow$ 10k $\Omega$ = 0)
Power-ON Output	F-92	0 = OFF at startup, 1 = On at startup
Master/Slave	F-93	0 = Master/Local 1 = Master/Parallel1 2 = Master/Parallel2 3 = Slave/Parallel 4 = Slave/Series
External Out Logic	F-94	0 = High ON, 1 = Low ON
Power Switch trip	F-95	0 = Enable , 1 = Disable
<b>Calibration Settings*</b>		
Calibration	F-00	0000 ~ 9999



\*Note

Power On and Calibration settings can only be set during power up.

## Normal Function Settings

Output ON Delay Time

Delays turning the output on for a designated amount of time. The Delay indicator will light when the Delay time is not 0.

Note: The Output ON Delay Time setting has a maximum deviation (error) of 20ms.

The Output ON Delay Time setting is disabled when the output is set to external control.

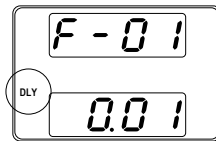

F-01

0.00s~99.99s

Output OFF Delay Time

Delays turning the output off for a designated amount of time. The Delay indicator will light when the Delay time is not 0.

Note: The Output OFF Delay Time setting has a maximum deviation (error) of 20ms.

The Output OFF Delay Time setting is disabled when the output is set to external control.

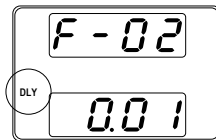

F-02

0.00s~99.99s

**V-I Mode** Selects High Speed Priority or Slew Rate Priority for CV or CC mode. The voltage or current slew rate can only be edited if CC/CV Slew Rate Priority is selected. The ISR indicator will be lit for CC Slew Rate Priority and the VSR indicator will be lit for CV Slew Rate Priority.

Note: CC and CV Slew Rate Priority mode are disabled when voltage/current output is set to external control.

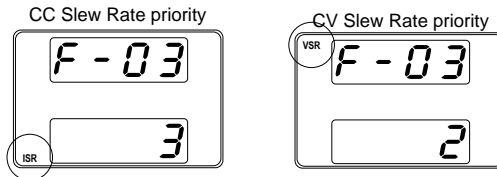

F-03

0 = CV high speed priority  
 1 = CC high speed priority  
 2 = CV slew rate priority  
 3 = CC slew rate priority

**Rising Voltage Slew Rate** Sets the rising voltage slew rate. Only applicable if V-I Mode is set to CV Slew Rate Priority.

F-04                      0.01V/s~60V/s (2260B-30-XX)  
                               0.1V/s~160V/s (2260B-80-XX)

**Falling Voltage Slew Rate** Sets the falling voltage slew rate. Only applicable if V-I Mode is set to CV Slew Rate Priority.

F-05                      0.01V/s~60V/s (2260B-30-XX)  
                               0.1V/s~160V/s (2260B-80-XX)

Rising Current Slew Rate	Sets the rising current slew rate. Only applicable if V-I Mode is set to CC Slew Rate Priority.
F-06	0.01A/s~72.00A/s (2260B-30-36) 0.1A/s~144.0A/s (2260B-30-72) 0.01A/s~27.00A/s (2260B-80-13) 0.01A/s~54.00A/s (2260B-80-27)
Falling Current Slew Rate	Sets the falling current slew rate. Only applicable if V-I Mode is set to CC Slew Rate Priority.
F-07	0.01A/s~72.00A/s (2260B-30-36) 0.1A/s~144.0A/s (2260B-30-72) 0.01A/s~27.00A/s (2260B-80-13) 0.01A/s~54.00A/s (2260B-80-27)
Internal Resistance Settings	Sets the internal resistance of the power supply.
F-08	0.000Ω ~0.833Ω (2260B-30-36) 0.000Ω ~0.417Ω (2260B-30-72) 0.000Ω ~5.926Ω (2260B-80-13) 0.000Ω ~2.963Ω (2260B-80-27)
Bleeder Control	Bleeder control turns ON/OFF the bleeder resistor. Bleeder resistors discharge the filter capacitors after power is turned off as a safety measure.
F-09	0 = OFF, 1 = ON
Buzzer ON/OFF	Turns the buzzer sound on or off. The buzzer is associated with alarm sounds and keypad entry sounds.
F-10	0 = ON, 1 = OFF

---

## USB/GPIB Settings

---

Front Panel USB State	Displays the front panel USB-A port state. This setting is not configurable. F-20                      0 = Absent, 1 = Mass Storage
Rear Panel USB State	Displays the rear panel USB-B port state. This setting is not configurable. F-21                      0 = Absent, 2 = USB-CDC, 3 = GPIB-USB adapter
Rear Panel USB Mode	Sets the rear panel USB mode. F-22                      0 = Disable, 1 = GPIB-USB adapter (for 2260B-GPIB-USB), 2 = USB CDC
GPIB Address	Sets the GPIB address. F-23                      0~30

## LAN Settings

MAC Address-1~6	Displays the MAC address 1~6. This setting is not configurable. F-30~F-35      0x00~0xFF
LAN	Turns Ethernet on or off. F-36      0 = Disable, 1 = Enable
DHCP	Turns DHCP on or off. F-37      0 = Disable, 1 = Enable
IP Address-1~4	Sets the default IP address. IP address 1~4 splits the IP address into four sections. (F-39 : F-40 : F-41 : F-42) (0~255 : 0~255 : 0~255 : 0~255)
Subnet Mask 1~4	Sets the subnet mask. The subnet mask is split into four parts. (F-43 : F-44 : F-45 : F-46) (0~255 : 0~255 : 0~255 : 0~255)
Gateway 1~4	Sets the gateway address. The gateway address is split into 4 parts. (F-47 : F-48 : F-49 : F-50) (0~255 : 0~255 : 0~255 : 0~255)
DNS Address 1~4	Sets the DNS address. The DNS address is split into 4 parts. (F-51 : F-52 : F-53 : F-54) (0~255 : 0~255 : 0~255 : 0~255)
Sockets active	Enables WebSocket connections. F-57      0 = Disable, 1 = Enable
Web server active	Turns Web server control on/off. F-59      0 = Disable, 1 = Enable

---

Web Password active	Turns a web password on/off.
F-60	0 = Disable, 1 = Enable
Web Password	Sets the Web password.
F-61	0000 ~ 9999

---

## System Settings

---

Factory Set Value	Returns the 2260B to the factory default settings. See page 136 for a list of the default settings.
F-88	0 = Disable, 1 = Return to factory default settings.
Show Version	Displays the 2260B version number, build date, keyboard version, analog-control version and kernel build.
F-89	0, 1 = Version 2, 3 = Build year 4, 5 = Build month/day 6, 7 = Keyboard CPLD version 8, 9 = Analog-Control CPLD version A, B = Reserved C, D = Kernel build year E, F = Kernel build month/day

---

Power On Configuration Settings

CV Control                      Sets the constant voltage (CV) control mode between local and external voltage/resistance control. For external voltage control, see page 101 (External Voltage Control of Voltage Output) and page 106 (External Resistance Control of Voltage Output).

F-90                              0= Panel control (local)  
                                          1 = External voltage control  
                                          2 = External resistance control  
                                          (Ext- $R \leq 10k\Omega = V_{o,max}$ )  
                                          3 = External resistance control  
                                          (Ext- $R \geq 10k\Omega = 0$ )

CC Control                      Sets the constant current (CC) control mode between local and external voltage/resistance control. For details on external voltage control, see page 104 (External Voltage Control of Current Output) and 108 (External Resistance Control of Current Output).

F-91                              0= Panel control (local)  
                                          1 = External voltage control  
                                          2 = External resistance control  
                                          (Ext- $R \leq 10k\Omega = I_{o,max}$ )  
                                          3 = External resistance control  
                                          (Ext- $R \geq 10k\Omega = 0$ )

Power-ON Output              Sets the power supply to turn the output on or off at power up.

F-92                              0 = OFF at startup, 1 = On at start up

Master/Slave                    Sets the power supply as master or slave. See the parallel/series operation for details, page 56.



	F-93	0 = Master/Local 1 = Master/Parallel1 2 = Master/Parallel2 3 = Slave/Parallel 4 = Slave/Series
External Out Logic	F-94	Sets the external logic as active high or low. 0= High ON, 1 = Low ON
Power Switch Trip	F-95	Turns the power off if enabled when the protection settings are tripped. 1 = Disable, 0 = Enable

## Calibration

Programmable Calibration	F-00	The calibration password is used to access the local mode calibration or other special functions. The password used determines which function is accessed. Please see your distributor for details. 0000 ~ 9999
--------------------------	------	--------------------------------------------------------------------------------------------------------------------------------------------------------------------------------------------------------------------

## Setting Normal Function Settings

The normal function settings (F-01~F-61, F-88~F-89) can be easily configured with the Function key.

- Ensure the load is not connected.
- Ensure the output is off.



Note

Function setting F-89 (Show Version) can only be viewed, not edited.

Configuration settings F-90~F-95 cannot be edited in the Normal Function Settings. Use the Power On Configuration Settings. See page 96 for details.

Steps

1. Press the Function key. The function key will light up.



2. The display will show F-01 on the top and the configuration setting for F-01 on the bottom.

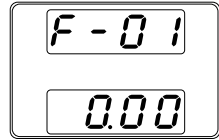

3. Rotate the Voltage knob to change the F setting.  
Range F-00~ F-61, F-88~F-89

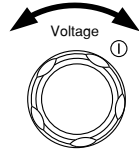

4. Use the Current knob to set the parameter for the chosen F setting.

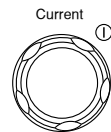

5. Press the Voltage knob to save the configuration setting. Conf will be displayed when successful.

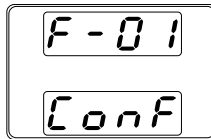
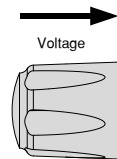

Exit

- Press the Function key again to exit the configuration settings. The function key light will turn off.



## Setting Power On Configuration Settings

### Background

The Power On configuration settings can only be changed during power up to prevent the configuration settings being inadvertently changed.

- Ensure the load is not connected.
- Ensure the power supply is off.

### Steps

1. Hold the Function key while turning the power on.
2. The display will show F-90 on the top and the configuration setting for F-90 on the bottom.

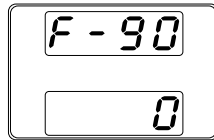
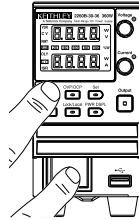

3. Rotate the Voltage knob to change the F setting.

Range F-90~ F-95

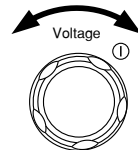

4. Use the Current knob to set the parameter for the chosen F setting.

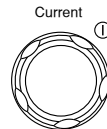

5. Press the Voltage knob to save the configuration setting. ConF will be displayed when successful.

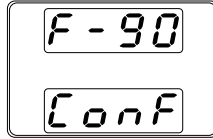
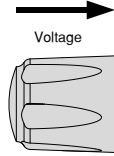

---

Exit

Cycle the power to save and exit the configuration settings.

# ANALOG CONTROL

The Analog Control chapter describes how to control the voltage or current output using an external voltage or resistance, monitor the voltage or current output as well as remotely turning off the output or shutting down the power supply.

---

<b>Analog Remote Control Overview .....</b>	<b>99</b>
Analog Control Connector Overview.....	99
External Voltage Control of Voltage Output .....	101
External Voltage Control of Current Output .....	104
External Resistance Control of Voltage Output .....	106
External Resistance Control of Current Output .....	108
External Control of Output .....	110
External control of Shutdown .....	113
<b>Remote Monitoring .....</b>	<b>115</b>
External Voltage and Current Monitoring .....	115
External Operation and Status Monitoring.....	117

## Analog Remote Control Overview

The 2260B power supply series have a number of analog control options. The Analog Control connectors are used to control output voltage and current using external voltage or resistance. The power supply output and power switch can also be controlled using external switches.

- Analog Control connector overview → from page 99
- External voltage control of voltage output → from page 101
- External voltage control of current output → from page 104
- External resistance control of voltage output → from page 106
- External resistance control of current output → from page 108
- External control of output → from page 110
- External control of the power switch → from page 113

## Analog Control Connector Overview

**Overview** The Analog Control Connector is a standard Mil 26 pin connector (OMRON XG4 IDC plug). The connector is used for all analog remote control. The pins used determine what remote control mode is used.



### WARNING

To prevent electric shock, ensure that the cover for the Analog Control Connector is used when the connector is not in use.

### Pin Assignment

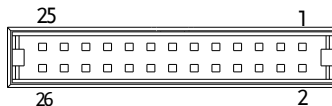

Pin name	Pin number	Description
Current Share	1	Used when operating 2 or more units in parallel.

D COM	2	Connected to the (-S) sense- terminal when remote sense is used. Connected to the negative output terminal when remote sense is not used.
CURRENT SUM OUT	3	Current sum output signal when used in parallel mode.
EXT-V CV CONT	4	External voltage control of the voltage output. A voltage of 0~10V is used to control the full scale voltage output (0%~100%) of the instrument.
EXT-V CC CONT	5	External voltage control of the current output. A voltage of 0~10V is used to control the full scale current output (0%~100%) of the instrument
EXT-R CV CONT PIN1	6	External resistance control of the voltage output. A resistance of 0k $\Omega$ ~ 10k $\Omega$ is used to control the full scale voltage output (0%~100%) of the instrument.
EXT-R CV CONT PIN2	7	External resistance control of the voltage output. A resistance of 0k $\Omega$ ~ 10k $\Omega$ is used to control the full scale voltage output (0%~100%) of the instrument.
EXT-R CC CONT PIN1	8	External resistance control of the current output. A resistance of 0k $\Omega$ ~ 10k $\Omega$ is used to control the full scale current output (0%~100%) of the instrument.
EXT-R CC CONT PIN2	9	External resistance control of the current output. A resistance of 0k $\Omega$ ~ 10k $\Omega$ is used to control the full scale current output (0%~100%) of the instrument.
V MON	10	Voltage Monitor Output. Outputs the full scale voltage (0~100%) as a voltage (0V~10V).
I MON	11	Current Monitor Output. Outputs the full scale current (0~100%) as a voltage (0V~10V).
SHUTDOWN	12	The shut down signal will turn off the output or power when a low TTL signal is applied. The shutdown signal is pulled up to 5V with a 10k $\Omega$ pull-up resistor.
CURRENT_SUM_1	13	Master unit current sum input signal from first slave CURRENT SUM OUTPUT. Used in parallel mode only.
CURRENT_SUM_2	14	Master unit current sum input signal from second slave CURRENT SUM OUTPUT. Used in parallel mode only.
FEEDBACK	15	Parallel control signal during master-slave parallel operation.

A COM	16	Analog signal common. Connected to the sense-terminal when remote sense is used. Connected to the negative output terminal when remote sense is not used.
STATUS COM	17	Common for status signals 18, 19, 20, 21 and 22.
CV STATUS	18	Turns on when CV mode is active. (photo coupled open collector output)
CC STATUS	19	Turns on when CC mode is active. (photo coupled open collector output)
ALM STATUS	20	Turns on when any of the protection modes are tripped (OVP, OCP) or if a shutdown signal is input. (photo coupled open collector output)
OUTPUT ON STATUS	21	Turns on when the output has been turned on. (photo coupled open collector output)
POWER OFF STATUS	22	Turns on when the power switch is turned off.
N.C.	23	Not connected
OUT ON/OFF CONT	24	Turns the output on/off when (default setting) a low TTL signal is applied. Internally, the circuit is pulled up to +5V with 10kΩ resistance.
SER SLV IN	25	Series slave input during master-slave series operation.
N.C.	26	Not connected

## External Voltage Control of Voltage Output

### Background

External voltage control of the voltage output is accomplished using the MIL-26 connector on the rear panel. A voltage of 0~10V is used to control the full scale voltage of the instrument, where:

$$\text{Output voltage} = \text{full scale voltage} \times (\text{external voltage}/10)$$



## Connection

When connecting the external voltage source to the MIL connectors, use shielded or twisted paired wiring.

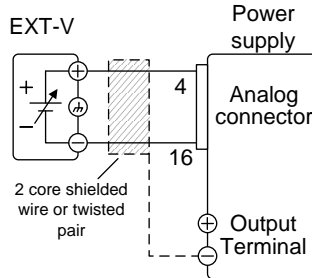

- Pin16 → EXT-V (-)
- Pin4 → EXT-V (+)
- Wire shield → negative (-) output terminal

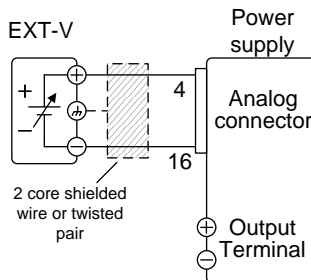

## Connection- alt. shielding

If the wire shield needs to be grounded at the voltage source (EXT-V), then the shield cannot also be grounded at the negative (-) terminal output of the 2260B power supply. This would short the output.



- Pin16 → EXT-V(-)
- Pin4 → EXT-V(+)
- Wire shield → EXT-V ground (GND)

Panel operation 1. Connect the external voltage according to the connection diagrams above.

2. Set the F-90 power on configuration setting to 1 (CV control – Ext voltage). Page 96
- Be sure to cycle the power after the power on configuration has been set.
3. Press the Function key and confirm the new configuration settings (F-90=1). Function
- 
4. Press the Output key. The voltage can now be controlled with the External voltage. Output
- 

**Note**

The input impedance for external voltage control is 10k $\Omega$ .

Use a stable voltage supply for the external voltage control.

**Note**

CV and CC Slew Rate Priority are disabled for V-I mode (F-03) when using external voltage control. See the normal function settings on page 87.

**CAUTION**

Ensure no more than 10.5 volts are input into the external voltage input.

Ensure the voltage polarity is correct when connecting the external voltage.

## External Voltage Control of Current Output

**Background** External voltage control of the current output is accomplished using the MIL-26 connector on the rear panel. A voltage of 0~10V is used to control the full scale current of the instrument, where:

$$\text{Output current} = \text{full scale current} \times (\text{external voltage}/10)$$

**Connection** When connecting the external voltage source to the MIL connectors, use shielded or twisted paired wiring.

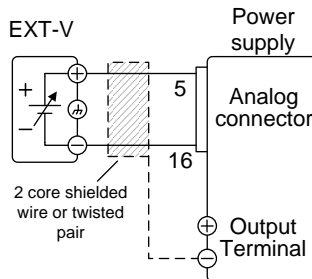

- Pin16 → EXT-V (-)
- Pin5 → EXT-V (+)
- Wire shield → negative (-) output terminal

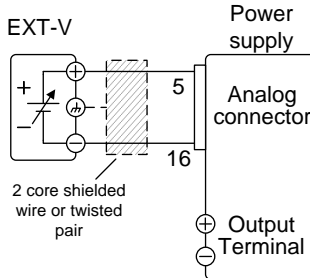

Connection- alt. shielding

If the wire shield needs to be grounded at the voltage source (EXT-V), then the shield cannot also be grounded at the negative (-) terminal output of the 2260B power supply. This would short the output.



- Pin16 → EXT-V (-)
- Pin5 → EXT-V (+)
- Wire shield → EXT-V ground (GND)

Steps

1. Connect the external voltage according to the connection diagrams above.
2. Set the F-91 power on configuration setting to 1 (CC control - Ext voltage). Page 96
  - Be sure to cycle the power after the power on configuration has been set.
3. Press the Function key and confirm the new configuration settings (F-91=1). Function 
4. Press the Output key. The current can now be controlled with the External voltage. Output 

**Note**

The input impedance for external voltage control is 10k $\Omega$ .

Use a stable voltage supply for the external voltage control.

**Note**

CV and CC Slew Rate Priority are disabled for V-I mode (F-03) when using external voltage control. See the normal function settings on page 87.

**CAUTION**

Ensure the voltage polarity is correct when connecting the external voltage.

Ensure no more than 10.5 volts are input into the external voltage input.

## External Resistance Control of Voltage Output

### Background

External resistance control of the voltage output is accomplished using the MIL-26 connector on the rear panel. A resistance of 0k $\Omega$ ~10k $\Omega$  is used to control the full scale voltage of the instrument.

The output voltage (0 to full scale) can be controlled with the external resistance going up (Ext-R  $\nearrow$ ) 0k $\Omega$ ~10k $\Omega$  (10k $\Omega$  =  $V_{o,max}$ ) or down (Ext-R  $\searrow$ ) 10k $\Omega$ ~0k $\Omega$  (10k $\Omega$  = 0).

For 0k $\Omega$ ~10k $\Omega$ : Output voltage = full scale voltage  $\times$  (external resistance/10)

For 10k $\Omega$ ~0k $\Omega$ : Output voltage = full scale voltage  $\times$  ([10-external resistance]/10)



Note

The Ext-R $\nabla$  configuration is recommended for safety reasons. In the event that the cables become accidentally disconnected, the voltage output will drop to zero. Under similar circumstances using Ext-R $\sloperight$ , an unexpected high voltage would be output.

If switches are used to switch between fixed resistances, use switches that avoid creating open circuits. Use short-circuit or continuous resistance switches.

Connection

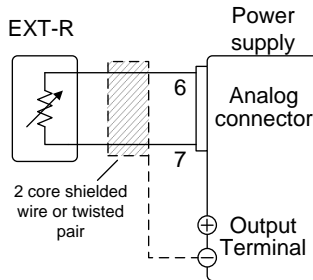

- Pin6 → EXT-R
- Pin7 → EXT-R
- Wire shield → negative (-) output terminal

Steps

1. Connect the external resistance according to the connection diagrams above.
2. Set the F-90 (CV Control) Page 96  
configuration settings to 2 for Ext-R $\sloperight$  or 3 for Ext-R $\nabla$ .
  - Be sure to cycle the power after the power on configuration has been set.
3. Press the Function key and confirm the new configuration settings (F-90=2 or 3). Function 

4. Press the Output key. The voltage can now be controlled with the External resistance.

Output



Note

Ensure the resistor(s) and cables used exceed the isolation voltage of the power supply. For example: insulation tubes with a withstand voltage higher than the power supply can be used.

When choosing an external resistor ensure the resistor can withstand a high degree of heat.



Note

CV and CC Slew Rate Priority are disabled for V-I mode (F-03) when using external resistance control. See the normal function settings on page 87.

## External Resistance Control of Current Output

### Background

External resistance control of the current output is accomplished using the MIL-26 connector on the rear panel. A resistance of  $0\text{k}\Omega\sim 10\text{k}\Omega$  is used to control the full scale current of the instrument.

The output current (0 to full scale) can be controlled with the external resistance going up (Ext-R )  $0\text{k}\Omega\sim 10\text{k}\Omega$  ( $10\text{k}\Omega = V_o, \text{max}$ ) or down (Ext-R )  $10\text{k}\Omega\sim 0\text{k}\Omega$  ( $10\text{k}\Omega = 0$ ).

For  $0\text{k}\Omega\sim 10\text{k}\Omega$ : Output current = full scale current  $\times$  (external resistance/10)

For  $10\text{k}\Omega\sim 0\text{k}\Omega$ : Output current = full scale current  $\times$  ([10-external resistance]/10)



Note

The Ext-R $\nabla$  configuration is recommended for safety reasons. In the event that the cables become accidentally disconnected, the current output will drop to zero. Under similar circumstances using Ext-R $\sphericalangle$ , an unexpected high current would be output.

If switches are used to switch between fixed resistances, use switches that avoid creating open circuits. Use short-circuit or continuous resistance switches.

Connection

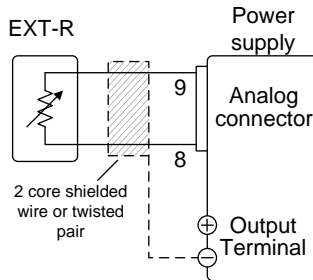

- Pin9 → EXT-R
- Pin8 → EXT-R
- Wire shield → negative (-) output terminal

Steps

1. Connect the external resistance according to the connection diagrams above.
1. Set the F-91 (CC Control) configuration settings to 2 for Ext-R $\sphericalangle$  or 3 for Ext-R $\nabla$ . Page 96
  - Be sure to cycle the power after the power on configuration has been set.
2. Press the Function key and confirm the new configuration settings (F-91=2 or 3). Function



3. Press the Output key. The current can now be controlled with the External resistance.

Output



Note

Ensure the resistor(s) and cables used exceed the isolation voltage of the power supply. For example: insulation tubes with a withstand voltage higher than the power supply can be used.

When choosing an external resistor ensure the resistor can withstand a high degree of heat.



Note

CV and CC Slew Rate Priority are disabled for V-I mode (F-03) when using external resistance control. See the normal function settings on page 87.

## External Control of Output

### Background

The output can be turned on or off externally using a switch. The analog control connector can be set to turn the output on from a high or low signal. The voltage across pins 2 and 24 are internally pulled to +5V  $\pm 5\%$  @ 500uA with 10k $\Omega$  pull-up resistor. A short (closed switch) produces a low signal.

When set to High = On, the output is turned on when the pins 2-24 are open.

When Low = On, the output is turned on when pins 2-24 are shorted.

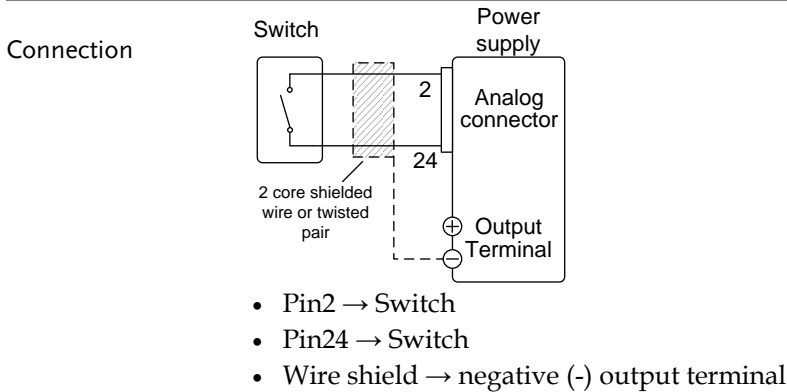

## Steps

1. Connect the external switch according to the connection diagrams above.

Set F-94 (External output logic) in Page 96 the power on configuration settings to 0 (High = On) or 1 (Low = On).

- Be sure to cycle the power after setting the power on configuration settings.
2. Press the Function key and confirm the new configuration settings. 
  3. The switch is now ready to set the output on or off.



Note

When using a switch over long distances, please use a switch relay to extend the line from the coil side of the relay.

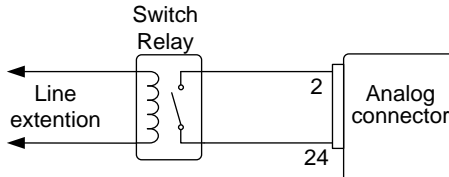

If a single switch control is to be used for multiple units, please isolate each instrument. This can be achieved by using a relay.



Warning

Ensure the cables used and the switch exceed the isolation voltage of the power supply. For example: insulation tubes with a withstand voltage higher than the power supply can be used.



Note

Messages: If F-94 = 0 (High = on) and the pin 24 is low (0) "MSG 001" will be displayed on the display.

If F-94 = 1 (Low = on) and the pin 24 is high (1) "MSG 002" will be displayed on the display.

Output off (High=on)

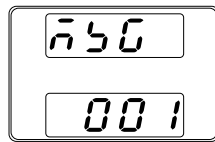

Output off (Low=on)





Note

Output ON/OFF Delay Time (F-01, F-02) are disabled when the output is set to external control. See the normal function settings on 87 for details.

## External control of Shutdown

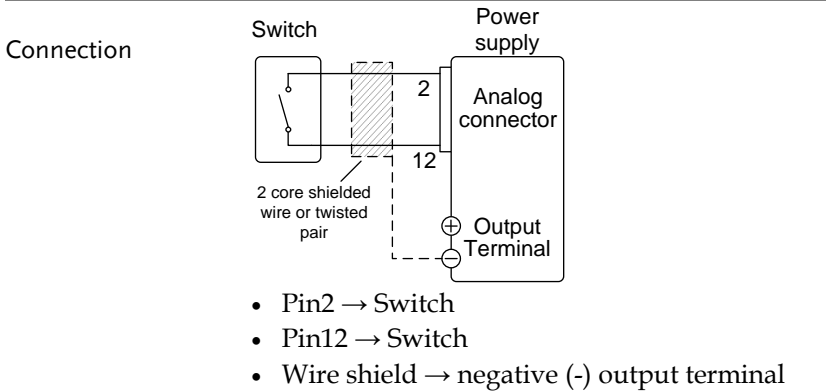
**Background** The output of the power supplies can be configured to shut down via an external switch. The ability to externally shut down the power supply must first be enabled in the power on configuration settings. The voltage across pins 2 and 12 are internally pulled to  $+5V \pm 5\%$  @  $500\mu A$  with  $10k\Omega$  pull-up resistor.



- Steps**
1. Connect the external switches according to the connection diagrams above.
  2. Set F-95 to in the configuration settings to 0 (Enable). This will allow the external control of shutdown. Page 96
  3. Press the function key and confirm the new configuration settings. Function 
  4. The switch will now shut down the power supply when shorted.

**Note**

When using a switch over long distances, please use a switch relay to extend the line from the coil side of the relay.

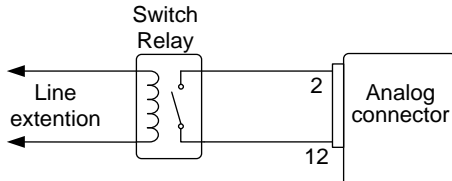

If a single switch control is to be used for multiple units, please isolate each instrument. This can be achieved by using a relay.

**Warning**

Ensure the cables and switch used exceed the isolation voltage of the power supply. For example: insulation tubes with a withstand voltage higher than the power supply can be used.

## Remote Monitoring

The 2260B power supplies have remote monitoring support for current and voltage output. They also support monitoring of operation and alarm status.

- External monitoring of output voltage and current → from page 115
- External monitoring of operation mode and alarm status → from page 117

## External Voltage and Current Monitoring

---

### Background

The MIL 26 pin connector is used to monitor the current (IMON) or voltage (VMON) output.

An output of 0~10V represents the voltage or current output of 0~ rated current/voltage output.

- $IMON = (\text{current output}/\text{full scale}) \times 10$
- $VMON = (\text{voltage output}/\text{full scale}) \times 10$

External voltage and current monitoring doesn't need to be enabled in the configuration settings.

---

### VMON Connection

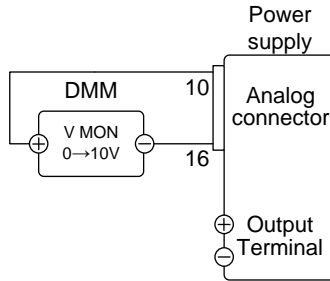

- Pin16 → Neg (-)
- Pin10 → Pos (+)

### IMON Connection

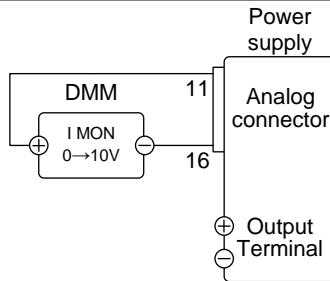

- Pin16 → Neg (-)
- Pin11 → Pos (+)



#### Note

The output impedance of the voltage (VMON) and current (IMON) monitor pins is 1k $\Omega$ .

Maximum current is 10mA.

The monitor outputs are strictly DC and should not be used to monitor analog components such as transient voltage response or ripple etc.



#### CAUTION

Ensure IMON(pin 11) and VMON(pin 10) are not shorted together. This will cause damage to the unit.

## External Operation and Status Monitoring

### Background

The MIL 26 pin connector can also be used to monitor the status operation and alarm status of the instrument.

The pins are isolated from the power supply internal circuitry by photo couplers. Status Com (Pin 17) is a photo coupler emitter output, while pins 18~22 are photo coupler collector outputs.

A maximum of 30V and 8mA can be applied to each pin.

Name and Pin	Description
STATUS COM 17	Common (photo coupler emitter) for status signals 18, 19, 20, 21 and 22.
CV STATUS 18	Low when CV mode is active.
CC STATUS 19	Low when CC mode is active.
ALM STATUS 20	Low when any of the protection modes are tripped (OVP, OCP). Active low.
OUT ON STATUS 21	Low when the output is on.
PWR OFF STATUS 22	Active low.

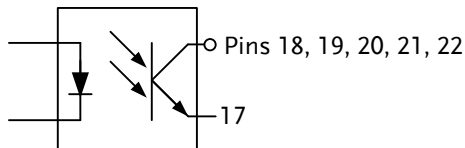



Timing diagrams Below are 4 example timing diagrams covering a number of scenarios. Note that pins 18~22 are all active low.

CV MODE:  
Output turned on The diagram below shows the timing diagram when the output is turned on when the 2260B is set to CV mode.

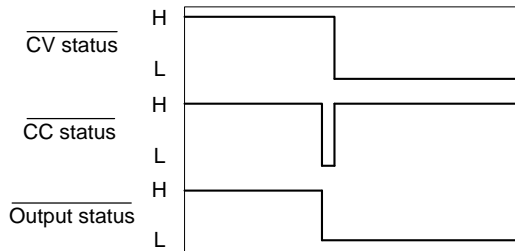

CV MODE:  
Output turned off The diagram below shows the output status lines when the output is turned off in CV mode.

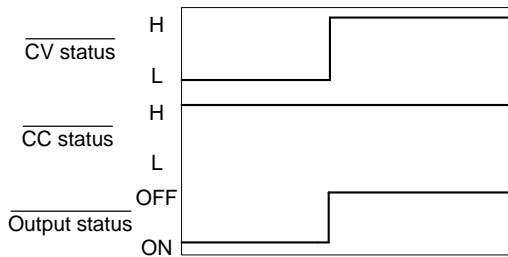

CC MODE:  
Output turned on

The diagram below shows the timing diagram when the output is turned on when the 2260B is set to CC mode.

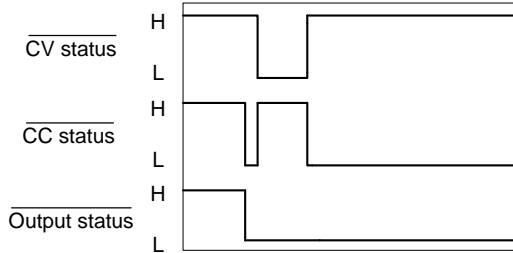

CC MODE:  
Output turned off

The diagram below shows the output status lines when the output is turned off in CC mode.

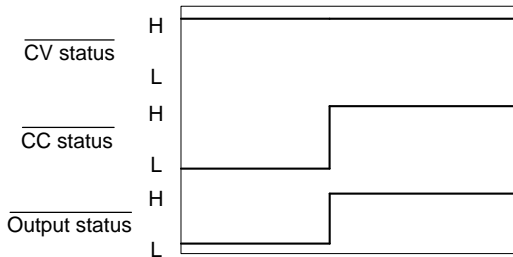

---

# COMMUNICATION

## INTERFACE

This chapter describes basic configuration of IEEE488.2 based remote control. For a command list, refer to the programming manual.

---

Interface Configuration .....	121
USB Remote Interface .....	121
Configure GPIB Interface .....	121
Configure Ethernet Connection .....	123
Web Server Configuration .....	123
Sockets Server Configuration .....	124
USB Remote Control Function Check .....	125
Web Server Remote Control Function Check .....	126

## Interface Configuration

### USB Remote Interface

USB configuration	PC side connector	Type A, host
	2260B side connector	Rear panel Type B, slave
	Speed	1.1/2.0 (full speed/high speed)
	USB Class	CDC (communications device class)

#### Steps

1. Connect the USB cable to the rear panel USB B port.

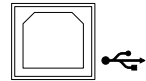

2. Change the Rear panel-USB (F-22) setting to USB-CDC (2).

Page 94

### Configure GPIB Interface

To use GPIB, the optional GPIB to USB (2260B-GPIB-USB) adapter must be used. Only one GPIB address can be used at a time.

#### Configure GPIB

1. Ensure the 2260B is off before proceeding.
2. Connect the USB cable from the rear panel USB B port on the 2260B to the USB A port on the GPIB to USB adapter.
3. Connect a GPIB cable from a GPIB controller to the GPIB port on the adapter.

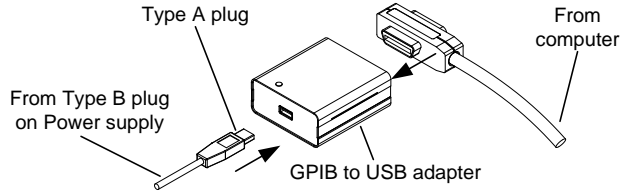

4. Turn the 2260B on.
5. Press the Function key to enter the Page 94 Normal configuration settings.

Set the following GPIB settings

F-22 = 1                      Set the rear panel USB port to GPIB-USB

F-23 = 0~30                Set the GPIB address (0~30)

---

GPIB constraints

- Maximum 15 devices altogether, 20m cable length, 2m between each device
- Unique address assigned to each device
- At least 2/3 of the devices turned On
- No loop or parallel connection

## Configure Ethernet Connection

The Ethernet interface can be configured for a number of different applications. Ethernet can be configured for basic remote control or monitoring using a web server or it can be configured as a socket server.

The 2260B series supports both DHCP connections so the instrument can be automatically connected to an existing network or alternatively, network settings can be manually configured.

---

Ethernet configuration Parameters	For details on how to configure the Ethernet settings, please see the configuration chapter on page 91.
MAC Address (display only)	LAN
DHCP	IP Address
Subnet Mask	Gateway
DNS Address	Sockets Active
Web Server Active	Web Password Active
Web set password	0000~9999 (default 0000)

## Web Server Configuration

---

Configuration This configuration example will configure the 2260B as a web server and use DHCP to automatically assign an IP address to the 2260B.

1. Connect an Ethernet cable from the network to the rear panel Ethernet port.

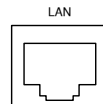

2. Press the Function key to enter the Page 94 Normal configuration settings.

Set the following LAN settings:

F-36 = 1	Enable LAN
F-37 = 1	Turn DHCP to enable
F-59 = 1	Turn the web server on



Note

It may be necessary to cycle the power or refresh the web browser to connect to a network.

## Sockets Server Configuration

Configuration This configuration example will configure the 2260B socket server.

The following configuration settings will manually assign the 2260B an IP address and enable the socket server. By default, the socket server port number is 2268 and cannot be configured.

1. Connect an Ethernet cable from the network to the rear panel Ethernet port.

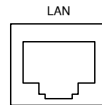

2. Press the Function key to enter the Page 94 Normal configuration settings.

Set the following LAN settings:

F-36 = 1	Enable LAN
F-37 = 0	Disable DHCP
F-39 = 172	IP Address part 1 of 4
F-40 = 16	IP Address part 2 of 4
F-41 = 5	IP Address part 3 of 4
F-42 = 133	IP Address part 4 of 4
F-43 = 255	Subnet Mask part 1 of 4
F-44 = 255	Subnet Mask part 2 of 4

---

F-45 = 128	Subnet Mask part 3 of 4
F-46 = 0	Subnet Mask part 4 of 4
F-43 = 172	Gateway part 1 of 4
F-44 = 16	Gateway part 2 of 4
F-45 = 21	Gateway part 3 of 4
F-46 = 101	Gateway part 4 of 4
F-57 = 1	Enable Sockets

---



Note

The socket function is only available for firmware version V1.12 or above. See page 92 to check your firmware version number.

## USB Remote Control Function Check

---

Functionality  
check

Invoke a terminal application such as MTTY (Multi-Threaded TTY).

To check the COM port No, see the Device Manager in the PC. For WinXP; Control panel → System → Hardware tab.

---

Run this query command via the terminal after the instrument has been configured for USB remote control (page 121).

\*idn?

This should return the Manufacturer, Model number, Serial number, and Firmware version in the following format.

- XXXXXX,AAAAAA,TW123456,01.00.20110101

Manufacturer: XXXXXX

Model number : AAAAAA

Serial number : TW123456

Firmware version : 01.00.20110101

---



- ^j can be used as the terminal character when entering the queries/commands from a terminal application.
- 



Note

For further details, please see the programming manual.

---

## Web Server Remote Control Function Check

---

Functionality  
check

Enter the IP address of the power supply in a web browser after the instrument has been configured as a web server (page 123).

http:// XXX.XXX.XXX.XXX

The web browser interface appears.

---



Note

For further details, please see the programming manual.

---

## Socket Server Function Check

---

Background

To test the socket server functionality, National Instruments Measurement and Automation Explorer can be used. This program is available on the NI website, [www.ni.com](http://www.ni.com), via a search for the VISA Run-time Engine page, or “downloads” at the following URL, <http://www.ni.com/visa/>

---

Requirements

Firmware: V1.12  
Operating System: Windows XP, 7

---

Functionality  
check

1. Start the NI Measurement and Automation Explorer (MAX) program. Using Windows,

press:

*Start>All Programs>National Instruments>Measurement & Automation*

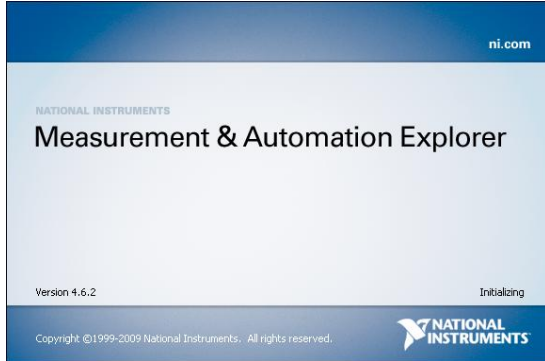

2. From the Configuration panel access;

*My System>Devices and Interfaces>Network Devices*

3. Press *Add New Network Device>Visa TCP/IP Resource...*

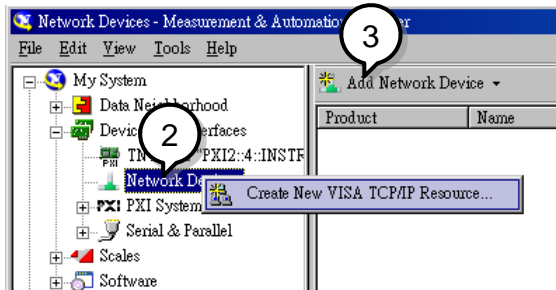

4. Select *Manual Entry of Raw Socket* from the popup window.

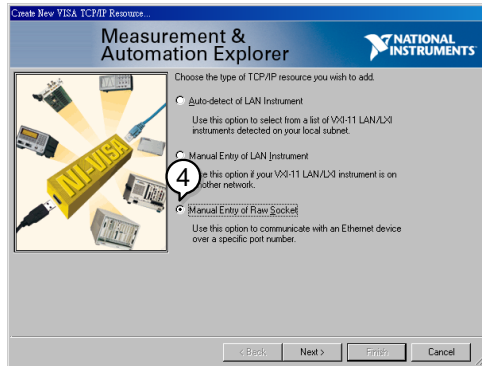

5. Enter the IP address and the port number of the 2260B. The port number is fixed at 2268.
6. Double click the Validate button.

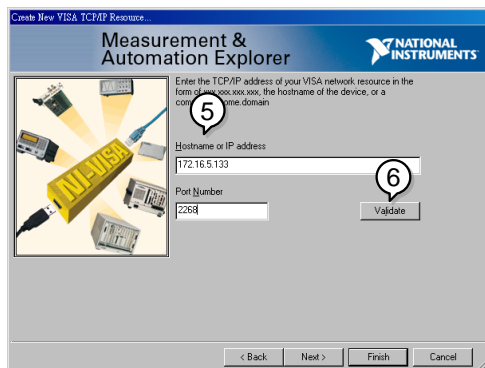

7. Next configure the Alias (name) of the 2260B connection. In this example the Alias is: PS\_DC1
8. Click finish.

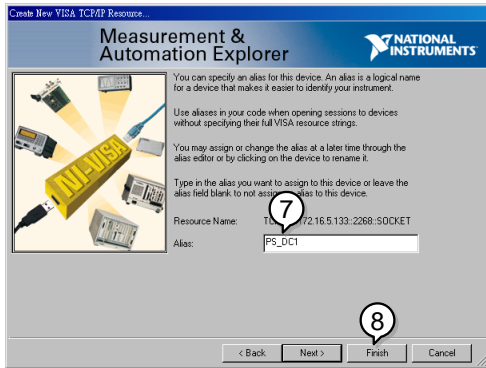

9. The IP address of the 2260B will now appear under Network Devices in the configuration panel. Select this icon now.

10. Press *Open VISA Test Panel*.

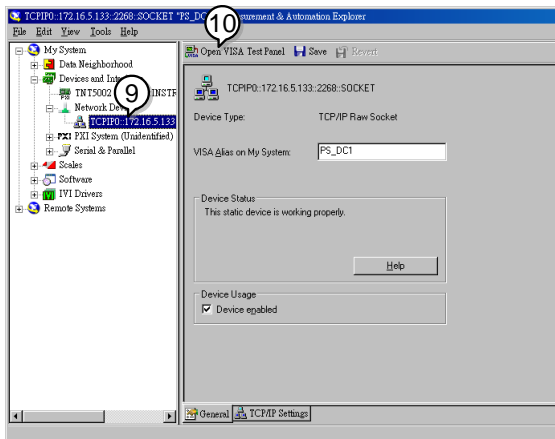

11. Under the *Template > Property Node* tabs, set *Termination Char Enable* from the *Attribute Name* list to *VI\_TRUE*.

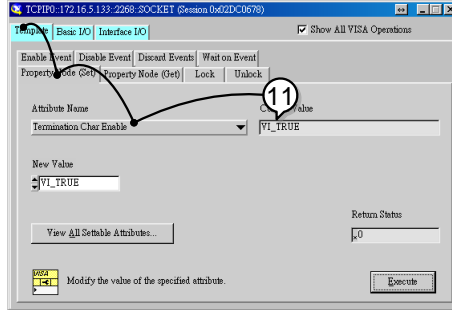

12. Under the *Basic I/O > Write* tabs, Enter the *\*IDN?* query into the *Buffer*, if it is not already there.

13. Click the *Execute* button.

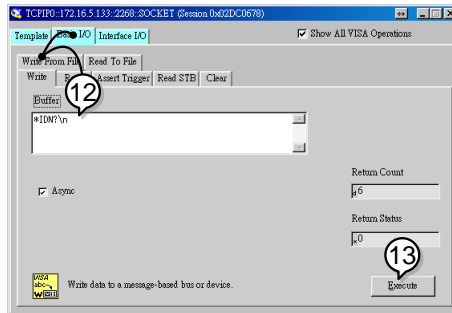

14. In the *Basic I/O > Read* tabs, the return parameter for the \*IDN? query should be returned to the buffer area:  
 XXXXXXX,AAA-AAA,,T1.12.20111013

Where: XXXXXXX = Manufacturer,  
 AAA-AAA = Model number.

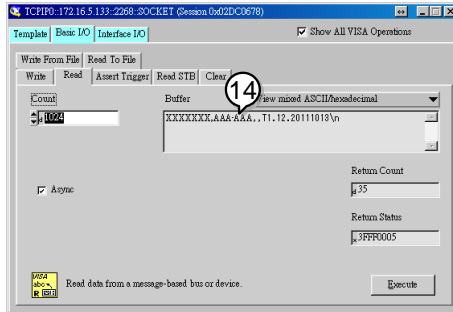

Note

For further details, please see the programming manual.

# MAINTENANCE

The 2260B power supply filters should be replaced on a periodic schedule to maintain performance and specification characteristics.

---

Replacing the Dust Filter .....	133
---------------------------------	-----

## Replacing the Dust Filter

The dust filter should be replaced at least 2 times a year. Not replacing the filter on a regular basis will reduce performance and may cause the unit to overheat.

---

- Front panel filter (all models)
1. Turn the instrument off.
  2. Pull the filter out from the bottom of the front panel.
  3. Replace the filter with a new filter.
- 

- Side panel filters (360W models)
1. Lift the side panel up and away from the case.
  2. Remove the filter from the grill and replace with a new filter.



# FAQ

---

- The power supply won't let me change the mode (CV mode ↔ CC mode).
- The OVP voltage is triggered earlier than expected.
- Can I combine more than 1 cable together for the output wiring?
- The accuracy does not match the specification.

The power supply won't let me change the mode (CV mode ↔ CC mode).

---

To set the power supply to CC or CV mode, the Function key must be held when the power is turned on to enter the Power On Configuration Mode. See page 92.

The OVP voltage is triggered earlier than expected.

---

When setting the OVP voltage, take into account the voltage drop from the load cables. As the OVP level is set from the output terminals and not the load terminals, the voltage at the load terminals may be slightly lower.

Can I combine more than 1 cable together for the output wiring?

---

Yes. Cables can be used together (in parallel) if the current capacity of a single cable is insufficient. However the withstand voltage should also be taken into account. Ensure the cables are twisted together and are the same length.

---

The accuracy does not match the specification.

---

Make sure the device is powered On for at least 30 minutes. This is necessary to stabilize the unit to match the specification. Some specifications require the operating temperature to be stabilized at  $23^{\circ}\text{C}\pm 5^{\circ}\text{C}$ . Please see the specifications for details.

For more information, contact your local Tektronix-Keithley representative.

# APPENDIX

## 2260B Default Settings

The following default settings are the factory configuration settings for the power supply.

For details on how to return to the factory default settings, see page 40.

Initial Settings	Default Setting	
Output	Off	
LOCK	0 (Disabled)	
Voltage	0V	
Current	0A	
OVP	Maximum	
OCP	Maximum	
Normal Function Settings	Setting	Default Setting
Output ON delay time	F-01	0.00s
Output OFF delay time	F-02	0.00s
V-I mode slew rate select	F-03	0 = CV high speed priority
Rising voltage slew rate	F-04	60.00V/s (2260B-30-XX) 160.0V/s (2260B-80-XX)
Falling voltage slew rate	F-05	60.00V/s (2260B-30-XX) 160.0V/s (2260B-80-XX)
Rising current slew rate	F-06	72.00A/s (2260B-30-36) 144.0A/s (2260B-30-72) 27.00A/s (2260B-80-13) 54.00A/s (2260B-80-27)

Falling current slew rate	F-07	72.00A/s (2260B-30-36) 144.0A/s (2260B-30-72) 27.00A/s (2260B-80-13) 54.00A/s (2260B-80-27)
Internal resistance setting	F-08	0.000Ω
Bleeder circuit control	F-09	1 = ON
Buzzer ON/OFF control	F-10	1 = ON
<b>USB/GPIB setting</b>		
Rear Panel USB Mode	F-22	2 = USB CDC
GPIB address	F-23	8
<b>LAN setting</b>		
LAN	F-36	1 = Enable
DHCP	F-37	1 = Enable
Sockets active	F-57	1 = Enable
Web Server active	F-59	1 = Enable
Web password active	F-60	1 = Enable
Web setting password	F-61	0000
<b>Power On Configuration</b>		
CV Control	F-90	0= Panel control (local)
CC Control	F-91	0= Panel control (local)
Power-ON Output	F-92	0 = OFF at startup
Master/Slave	F-93	0 = Master/Local
External Out Logic	F-94	0= High ON
Power Switch trip	F-95	0 = Enable

## Error Messages & Messages

The following error messages or messages may appear on the 2260B screen during operation.

Error Messages	Description
Err 001	USB Mass Storage is not present
Err 002	No (such)file in USB mass storage
Err 003	Empty memory location
Err 004	File access error
Err 901	Keyboard CPLD error
Err 902	Analog CPLD error
Err 920	The ADC is over range for calibration
Err 921	The DAC is over range for calibration
Err 922	Point invalid for calibration

Messages	Description
MSG 001	External control of output. Output off (F-94=0, High=on)
MSG 002	External control of output. Output off (F-94=1, Low=on)
MSG 003	F-93 is not zero. Unable to calibrate.

## LED Display Format

Use the following table to read the LED display messages.

0	1	2	3	4	5	6	7	8	9	A	B	C	D
0	1	2	3	4	5	6	7	8	9	A	b	C	d
E	F	G	H	I	J	K	L	M	N	O	P	Q	R
E	F	G	H	I	J	K	L	M	N	O	P	Q	R
S	T	U	V	W	X	Y	Z	( )	+	-	,		
S	T	U	V	W	X	Y	Z	( )	+	-	,		

## 2260B Specifications

The specifications apply when the 2260B is powered on for at least 30 minutes.

### 2260B-30-36, 2260B-80-13

Model		2260B-30-36	2260B-80-13
DC Output Ratings:	Voltage	30V	80V
	Current	36A	13.5A
	Power	360W	360W
Load Effect:	Voltage	0.05% of rating + 5mV	
	Current	0.1% of rating + 5mA	
Source Effect: (change from 85-132 VAC input or 170-265 VAC input)			
	Voltage	0.05% of rating + 3mV	
	Current	0.1% of rating + 5mA	
Output Ripple and Noise: (Noise Bandwidth=20MHz, Ripple Bandwidth=1MHz)			
	CV p-p	60mV	60mV
	CV rms	7mV	7mV
	CC rms	72mA	27mA
Programming accuracy (at 23°C±5°C)	Voltage	0.1% + 10mV	0.1% + 10mV
	Current	0.1% + 30mA	0.1% + 10mA
Measurement accuracy (at 23°C±5°C)	Voltage	0.1% + 10mV	0.1% + 10mV
	Current	0.1% + 30mA	0.1% + 10mA
Load Transient Recovery Time: (time for output voltage to recover within 0.1% + 10mV of its rated output for a load change from 50 to 100% of its rated output current)			
	Time	1ms	1ms
Output Response Time:			
	Rise time	50ms	50ms
	Fall time, Full load	50ms	50ms
	Fall time, no load	500ms	500ms
Programming/ Measurement Resolution:	Voltage	1mV (by PC remote control mode)	2mV
	Current	1mA (by PC remote control mode)	1mA

Series and Parallel Capability		
	Parallel operation	Up to 3 units including the master unit
	Series operation	Up to 2 units including the master unit
Temperature Coefficient: (after a 30 minute warm-up)		
	Voltage	100ppm/°C
	Current	200ppm/°C
Protection Function		
	OVP setting range	10% to 110% of rated output voltage range
	OVP accuracy	$\pm(\text{Rated output voltage} \times 2\%)$
	OCP setting range	10% to 110% of rated output current range
	OCP accuracy	$\pm(\text{Rated output current} \times 2\%)$
	OTP	Activated by elevated internal temperatures
Analog Programming and monitoring (at 23°C±5°C)		
	EXT-V Control V <sub>o</sub>	Accuracy & linearity = +/-0.5% of rated V <sub>out</sub>
	EXT-V Control I <sub>o</sub>	Accuracy & linearity = +/-1% of rated I <sub>out</sub>
	EXT-R Control V <sub>o</sub>	Accuracy & linearity = +/-1.5% of rated V <sub>out</sub>
	EXT-R Control I <sub>o</sub>	Accuracy & linearity = +/-1.5% of rated I <sub>out</sub>
	V <sub>o</sub> Monitor	Accuracy = 1%
	I <sub>o</sub> Monitor	Accuracy = 1%
Front Panel Display Accuracy: 4 digits (at 23°C±5°C)		
	Voltage	0.1% ± 2 count      0.1% ± 2 count
	Current	0.1% ± 4 count      0.1% ± 2 count
Environmental Conditions:		
	Operating temp.	0°C to 50°C
	Storage temp.	-25°C to 70°C
	Operating humidity	20% to 85% RH; No condensation
	Storage humidity	90% RH or less; No condensation
Interface		
	USB	Type A: Host, Type B: Slave, Speed: 1.1/2.0, USB Class: CDC(Communications Device Class)
	LAN	MAC Address, DNS IP Address, User Password, Gateway IP Address, Instrument IP Address, Subnet Mask
	GPIB	Optional: 2260B-GPIB-USB (GPIB to USB Adapter)

AC Input: Input	Nominal Input	100 - 240 VAC; 50/60Hz	
	Input Range	85VAC ~ 265VAC	
	Frequency	47Hz ~ 63Hz	
	Hold up Time	> 20ms (at rated load)	
	Input Current	5A@100VAC / 2.5A@200VAC	
	Power (max)	500VA	
	Power Factor (typ)	0.98	
	Efficiency (typ)	75%	78%
	Inrush Current	< 25Apeak	
General	Weight	Approx. 3kg	
	Dimensions	W×H×D = 71×124×350 mm	
	Withstand Voltage	Between input and chassis: No abnormalities at 1500 Vac for 1 minute.	
		Between input and output: No abnormalities at 3000 Vac for 1 minute.	
		Between output and chassis: No abnormalities at 500 Vdc for 1 minute.	
Insulation Resistance	Chassis and output terminal; chassis and AC input; AC input and output terminal: 100MΩ or more (DC 500V)		



## 2260B-30-72, 2260B-80-27

Model		2260B-30-72	2260B-80-27
DC Output Ratings:	Voltage	30V	80V
	Current	72A	27A
	Power	720W	720W
Load Effect:	Voltage	0.05% of rating + 5mV	
	Current	0.1% of rating + 5mA	
Source Effect: (change from 85-132 VAC input or 170-265 VAC input)			
	Voltage	0.05% of rating + 3mV	
	Current	0.1% of rating + 5mA	
Output Ripple and Noise: (Noise Bandwidth=20MHz, Ripple Bandwidth=1MHz)			
	CV p-p	80mV	80mV
	CV rms	11mV	11mV
	CC rms	144mA	54mA
Programming accuracy (at 23°C±5°C)	Voltage	0.1% + 10mV	0.1% + 10mV
	Current	0.1% + 60mA	0.1% + 30mA
Measurement accuracy (at 23°C±5°C)	Voltage	0.1% + 10mV	0.1% + 10mV
	Current	0.1% + 60mA	0.1% + 30mA
Load Transient Recovery Time: (time for output voltage to recover within 0.1% + 10mV of its rated output for a load change from 50 to 100% of its rated output current)			
	Time	1ms	1ms
Output Response Time:			
	Rise time	50ms	50ms
	Fall time, full load	50ms	50ms
	Fall time, no load	500ms	500ms
Programming/ Measurement Resolution:	Voltage	1mV	2mV
	Current	(by PC remote control mode)	
	Current	2mA	2mA
		(by PC remote control mode)	
Series and Parallel Capability			
	Parallel operation	Up to 3 units including the master unit	
	Series operation	Up to 2 units including the master unit	
Temperature Coefficient: (after a 30 minute warm-up)			
	Voltage	100ppm/°C	
	Current	200ppm/°C	

Protection Function	OVP setting	10% to 110% of rated output voltage range		
	OVP accuracy	$\pm(\text{Rated output voltage} \times 2\%)$		
	OCP setting	10% to 110% of rated output current range		
	OCP accuracy	$\pm(\text{Rated output current} \times 2\%)$		
	OTP	Activated by elevated internal temperatures		
Analog Programming and monitoring (at 23°C±5°C)				
	EXT-V Control	Accuracy & linearity = +/-0.5% of rated Vout		
	EXT-V Control	Accuracy & linearity = +/-1% of rated Iout		
	EXT-R Control	Accuracy & linearity = +/-1.5% of rated Vout		
	EXT-R Control	Accuracy & linearity = +/-1.5% of rated Iout		
	Vo Monitor	Accuracy = 1%		
	Io Monitor	Accuracy = 1%		
Front Panel Display Accuracy: 4 digits (at 23°C±5°C)				
	Voltage	0.1% ± 2 count	0.1% ± 2 count	
	Current	0.1% ± 7 count	0.1% ± 4 count	
Environmental Conditions:	Operating temp.	0°C to 50°C		
	Storage temp.	-25°C to 70°C		
	Operating humidity	20% to 85% RH; No condensation		
	Storage humidity	90% RH or less; No condensation		
Interface	USB	Type A: Host, Type B: Slave, Speed: 1.1/2.0, USB Class: CDC(Communications Device Class)		
	LAN	MAC Address, DNS IP Address, User Password, Gateway IP Address, Instrument IP Address, Subnet Mask		
	GPIB	Optional: 2260B-GPIB-USB (GPIB to USB Adapter)		
AC Input:	Nominal Input	100 - 240 VAC; 50/60Hz		
	Input Range	85VAC ~ 265VAC		
	Frequency	47Hz ~ 63Hz		
	Hold up Time	> 20ms (at rated load)		
	Input Current	10A@100VAC / 5A@200VAC		
	Power (max)	1000VA		
	Power Factor (typ)	0.98		
	Efficiency (typ)	75%	78%	
	Inrush Current	< 50Apeak		

---

General	Weight	Approx. 5kg
	Dimensions	W×H×D = 142×124×350 mm
	Withstand Voltage	Between input and chassis: No abnormalities at 1500 Vac for 1 minute.
		Between input and output: No abnormalities at 3000 Vac for 1 minute.
		Between output and chassis: No abnormalities at 500 Vdc for 1 minute.
Insulation Resistance	Chassis and output terminal; chassis and AC input; AC input and output terminal: 100MΩ or more (DC 500V)	

# 2260B Dimensions

360W models

2260B-80-13/2260B-30-36 (mm)

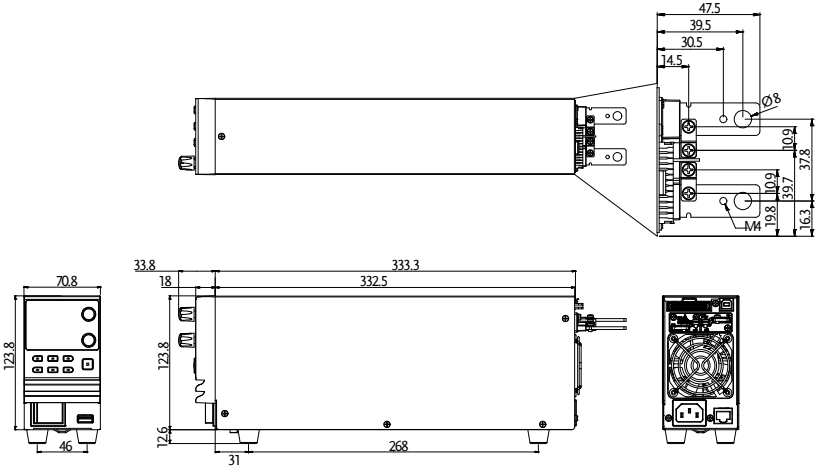

720W models

2260B-80-27/2260B-30-72 (mm)

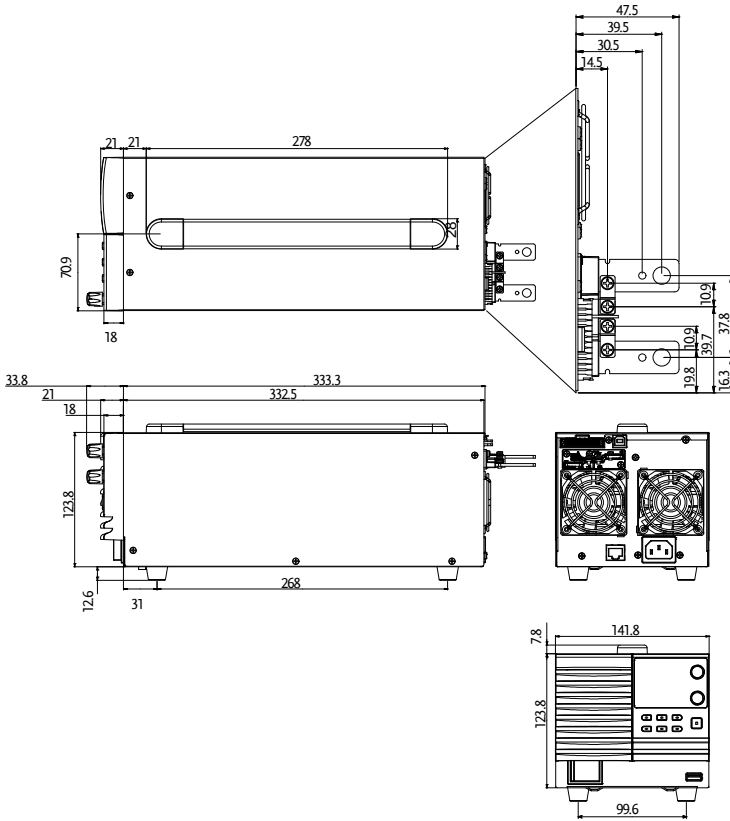

## Declaration of Conformity

We declare that the below mentioned product

**Type of Product: Multi-Range DC Power Supply**

**Model Number:** 2260B-30-36, 2260B-80-13, 2260B-30-72, 2260B-80-27

are herewith confirmed to comply with the requirements set out in the Council Directive on the Approximation of the Law of Member States relating to Electromagnetic Compatibility (2004/108/EC) and Low Voltage Directive (2006/95/EC).

For the evaluation regarding the Electromagnetic Compatibility and Low Voltage Directive, the following standards were applied:

© EMC	
EN 61326-1: EN 61326-2-1:	Electrical equipment for measurement, control and laboratory use -- EMC requirements (2006)
Conducted & Radiated Emission EN 55011: 2009+A1:2010	Electrostatic Discharge EN 61000-4-2: 2009
Current Harmonics EN 61000-3-2: 2006+A1: 2009+A2: 2009	Radiated Immunity EN 61000-4-3: 2006+A1:2008+A2:2010
Voltage Fluctuations EN 61000-3-3: 2008	Electrical Fast Transients IEC 61000-4-4: 2004+A1:2010
-----	Surge Immunity EN 61000-4-5: 2006
-----	Conducted Susceptibility EN 61000-4-6: 2009
-----	Power Frequency Magnetic Field EN 61000-4-8: 2010
-----	Voltage Dip/ Interruption EN 61000-4-11: 2004

Low Voltage Equipment Directive 2006/95/EC	
Safety Requirements	EN 61010-1: 2010 EN 61010-2-030: 2010

# INDEX

- Accessories ..... 10
- Alarm
  - description ..... 24
- Analog connector
  - pin assignment..... 99
- Analog control
  - output control ..... 110
  - overview ..... 98
  - remote monitoring ..... 115
  - resistance control – current
    - output ..... 108
  - resistance control – voltage
    - output ..... 106
  - shutdown control ..... 113
  - status monitoring ..... 117
  - voltage control – current output 104
  - voltage control – voltage output 101
- Bleeder control
  - Description ..... 22
- Build date
  - view ..... 41
- Caution symbol..... 3
- CC and CV mode
  - description ..... 20
- CC mode
  - operation ..... 48
- Cleaning the instrument ..... 5
- Configuration
  - calibration settings. .... 94
  - LAN settings ..... 91
  - Normal function settings ..... 87
  - normal function settings
    - operation ..... 94
  - overview ..... 84
  - power on configuration operation 96
  - power on configuration settings. 93
  - System settings ..... 92
  - table ..... 84
  - test sequence settings ..... 75
  - USB/GPIB settings ..... 90
  - utility function settings ..... 76
- Conventions ..... 38
- CV mode
  - operation ..... 45
- Declaration of conformity ..... 147
- Default settings ..... 136
  - reset ..... 40
- Dimensions
  - diagram ..... 145
- Display format ..... 138
- Display mode
  - operation ..... 51
- Disposal instructions ..... 5
- EN61010
  - measurement category ..... 4
  - pollution degree ..... 5
- Environment
  - safety instruction ..... 5
- Error messages ..... 138
  - test sequences ..... 81
- Ethernet
  - interface ..... 123
  - sockets ..... 124
  - web server ..... 123
- FAQ ..... 134
- Filter installation ..... 31
- Front panel diagram ..... 12
- Ground
  - symbol ..... 3
- Grounding ..... 28
- Internal resistance
  - description ..... 23
- LED conversion ..... 138
- List of features ..... 9
- Load connection ..... 34
- Maintenance
  - replacing the filter ..... 133

Marketing	
contact .....	135
Messages .....	138
Model differences .....	8
OCP level .....	43
Operating area description .....	18
Operation considerations .....	25
floating output .....	28
inrush current .....	25
Pulsed loads .....	25
reverse current .....	26
OVP level .....	43
Package contents .....	11
Panel lock .....	52
Parallel mode	
connection .....	60
operation .....	62
overview .....	57
Power on/off	
safety instruction .....	4
Power up .....	32
Rack mount	
description .....	37
Rear panel diagram .....	15
Remote control .....	120
interface configuration .....	121
Remote control function check .....	125
Remote sense	
connection .....	55
operation .....	53
Series mode	
connection .....	67
Operation .....	68
overview .....	65
Service operation	
about disassembly .....	4
contact .....	135
Slew rate	
description .....	22
Socket server function check .....	126
Specifications .....	139
2260A-30-36 .....	139
2260A-30-72W .....	142
2260A-80-13 .....	139
2260A-80-27W .....	142
System version	
view .....	41
Test sequence	
error messages .....	81
Export .....	79
Load .....	77
remove/delete test sequence .....	80
Run .....	78
UK power cord .....	6
Warning symbol .....	3
Web server function check .....	126
Wire gauge chart .....	33



Specifications are subject to change without notice.  
All Keithley trademarks and trade names are the property of Keithley Instruments, Inc.  
All other trademarks and trade names are the property of their respective companies.

**Keithley Instruments, Inc.**

Corporate Headquarters • 28775 Aurora Road • Cleveland, Ohio 44139 • 440-248-0400 • Fax: 440-248-6168 • 1-888-KEITHLEY • [www.keithley.com](http://www.keithley.com)

---



A Greater Measure of Confidence