

HIOKI

CM3286-50

AC CLAMP POWER METER

Instruction Manual



Read carefully before use.

Keep for future reference.



EN

Dec. 2021 Edition 1
CM3286C961-00 21-12H



Contents

Introduction	1
Options	5
Safety Information	7
Precautions for Use	11
Part Names	16
Operation Keys	17
■ Rotary switch	19
■ Power-on option table (beeping, resetting the instrument to the factory settings, etc.)	20
Installing and Replacing Batteries	22
■ Battery installation/replacement procedure	23
Z3210 Wireless Adapter (option)	25
■ Z3210 Wireless Adapter installation/replacement procedure	26
Test Leads	27
Inspection Before Measurement	30

Screen, Basic Operation	31
■ Screen display.....	32
■ Switching the information shown on the measurement display.....	33
Connecting the Clamp and Clips	36
Current/Voltage Measurement (Frequency) [\tilde{V} \tilde{A}]	37
Power Measurement (Power, Power Factor)	38
■ AC single-phase measurement (1P2W) [var VA W].....	38
■ AC single-phase measurement (1P3W) [var VA W].....	39
■ AC 3-phase measurement (3P3W, balanced) [3PW].....	40
■ AC 3-phase measurement (3P3W, unbalanced) [3PW]	41
■ AC 3-phase measurement (3P4W, balanced) [3PW].....	43
■ AC 3-phase measurement (3P4W, unbalanced) [3PW]	44
Phase Detection [Phase Detect]	47
Single-phase Active Energy Measurement (Integrated Measurement) [Setting Wh]	49
Single-phase Energy Meter Comparison Function [Setting Wh]	51
■ Setting the desired meter constant.....	55
Manual Hold, Automatic Hold	57

Switching Ranges	60
Max., Min., and Average Values (MAX/MIN/AVG)	61
Backlight, Automatic Power Save (APS)	64
Measurement Using the Clamp Adapter	65
Wireless Communications Function	66
■ GENNECT Cross (application software)	66
■ Z3210-to-Excel® direct data entry function (Excel® direct input function, HID function).....	71
Specifications	75
■ General specifications	75
■ Input, output, and measurement specifications	78
■ Harmonic measurement specifications (with Z3210 connected).....	81
Accuracy Table	83
Equations	94
Maintenance and Service	100
Troubleshooting	102
Warranty Certificate	

Contents

Introduction

Thank you for choosing the Hioki CM3286-50 AC Clamp Power Meter. To ensure your ability to get the most out of this instrument over the long term, please read this manual carefully and keep it available for future reference.

Read the separate document “Operating Precautions” carefully before using the instrument.

This clamp power meter provides functionality for measuring AC current, voltage, power, and frequency as well as for detecting phase.

By connecting the Z3210 Wireless Adapter (option), you can record measurement data from the instrument and create reports on a mobile device.

Latest instruction manual

The contents of this manual are subject to change, for example as a result of product improvements or changes to specifications.

The latest edition can be downloaded from Hioki’s website.

<https://www.hioki.com/global/support/download>



Intended audience

This manual has been written for use by individuals who use the product or provide information about how to use the product. In explaining how to use the product, it assumes electrical knowledge (equivalent of the knowledge possessed by a graduate of an electrical program at a technical high school).

Trademarks

- Microsoft Excel is a registered trademark or trademark of Microsoft Corporation in the United States and other countries.
- The Bluetooth® word mark and logos are registered trademarks owned by Bluetooth SIG, Inc. and any use of such marks by Hioki E.E. Corporation is under license. Other trademarks and trade names are those of their respective owners.

Precautions during shipment

Handle it carefully so that it is not damaged due to a vibration or shock.

Package contents

When you receive the instrument, inspect it carefully to ensure that no damage occurred during shipping. In particular, check the accessories, panel switches, and connectors. If damage is evident, or if it fails to operate according to the specifications, contact your authorized Hioki distributor or reseller.

- Model CM3286-50
AC Clamp Power Meter

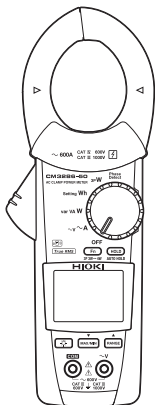

Accessories

- Model L9257 Connection Cord
(Model L4930 Connection Cable Set (1.2 m)
+ Model L4935 Alligator Clip Set)
CAT IV 600 V, CAT III 1000 V, CAT II 1000 V, 10 A

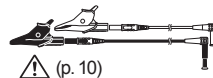

- Model C0203 Carrying Case



- LR03 Alkaline battery ×2



- Instruction Manual (this manual)



- Operating Precautions (0990A907)



Accuracy labeling

The instrument accuracy's is expressed by defining a percentage of the reading, a percentage of full scale, and limit value for errors in terms of digits.

Reading (displayed value)	Indicates the value displayed by the instrument. Limit values for reading errors are expressed as a percentage of the reading (“% of reading” or “% rdg”).
Full scale (maximum display value)	Indicates the maximum display value for each measurement range. Measurement range values for the instrument indicates that maximum display value. Limit values for full-scale errors are expressed as a percentage of full scale (“% of full scale” or “% f.s.”).
Digit (resolution)	Indicates the minimum display unit (in other words, the smallest digit that can have a value of 1) for a digital measuring instrument. Limit values for digit errors are expressed using digits (“digits” or “dgt”).

Screen display

The instrument screen displays the alphanumeric characters as follows.

A	B	C	D	E	F	G	H	I	J	K	L	M	N	O	P	Q	R	S	T	U	V	W	X	Y	Z
A	b	C	d	E	F	G	H		u	v	L	n	o	P	q	r	S	t	U	v	y	1	4		

1	2	3	4	5	6	7	8	9	0
1	2	3	4	5	6	7	8	9	0

Options

The options listed below are available for the instrument. To order an option, please contact your authorized Hioki distributor or reseller. Options are subject to change. Please check Hioki's website for the latest information.

Model C0207 Carrying Case

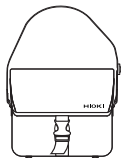

This bag-style case protects the instrument while it's being transported or stored.
Approx. 360W × 300H × 160D mm

Model C0203 Carrying Case



This case comes with the instrument.

Model Z3210 Wireless Adapter (p. 25)



Connecting the Z3210 to the instrument enables the wireless communication function.
See "Wireless Communications Function" (p. 66)

Options

Connection cables and test leads : See p. 10

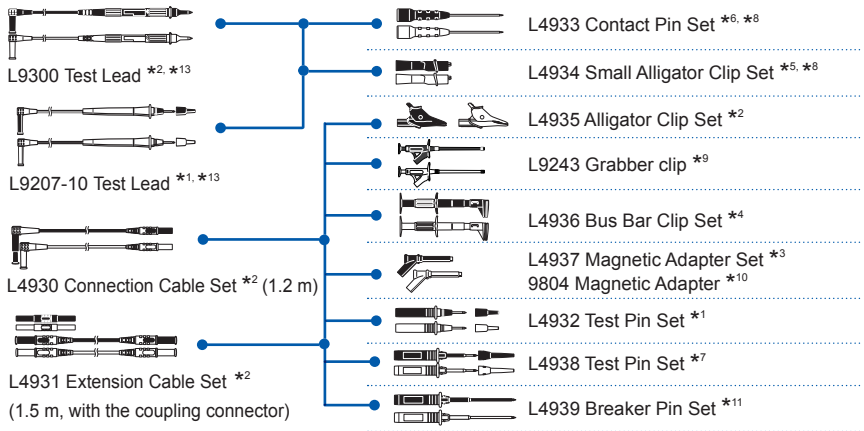

*1: CAT IV 600 V, CAT III 1000 V, CAT II 1000 V, 10 A

*2: CAT IV 600 V, CAT III 1000 V, 10 A

*3: CAT III 1000 V, 2 A

*4: CAT III 600 V, 5 A

*5: CAT III 300 V, CAT II 600 V, 3 A

*6: AC30 V, DC60 V, 3 A

*7: CAT III 600V, CAT II 600V, 10 A

*8: Can be connected to tip of the L4932

*9: CAT II 1000 V, 1 A

*10: CAT IV 1000 V, 2 A

*11: CAT III 600V, 10 A

*12: CAT II 600 V, 1000 A

*13: When connecting the L4933 or L4934, configure the instrument for CAT II measurement. See "Test Leads" (p. 27).



9290-10
Clamp on
Adapter*12

Safety Information

This instrument is designed to conform to IEC 61010 Safety Standards, and has been thoroughly tested for safety prior to shipment. However, using the instrument in a way not described in this manual may negate the provided safety features.

Before using the instrument, be certain to carefully read the following safety notes.

DANGER



Mishandling during use could result in injury or death, as well as damage to the instrument. Be certain that you understand the instructions and precautions in the manual before use.

WARNING



With regard to the electricity supply, there are risks of an electric shock, a heat generation, a fire, and an arc flash due to short-circuit. Individuals using an electrical measuring instrument for the first time should be supervised by a technician who has experience in electrical measurement.

 **WARNING**







Protective gear









This instrument is measured on a live line. To prevent an electric shock, use appropriate protective insulation and adhere to applicable laws and regulations.

Symbols and abbreviations

In this document, the risk seriousness and the hazard levels are classified as follows.

 DANGER	Indicates an imminently hazardous situation that will result in death or serious injury to the operator.	IMPORTANT	Indicates information related to the operation of the instrument or maintenance tasks with which the operators must be fully familiar.
 WARNING	Indicates a potentially hazardous situation that may result in death or serious injury to the operator.		Indicates prohibited actions.
 CAUTION	Indicates a potentially hazardous situation that may result in minor or moderate injury to the operator or damage to the instrument or malfunction.		Indicates the action which must be performed.

Symbols on the instrument

	<p>Indicates cautions and hazards. When the symbol is printed on the instrument, refer to a corresponding topic in the Instruction Manual.</p>		<p>Indicates AC (Alternating Current).</p>
	<p>Indicates that dangerous voltage may be present at this terminal.</p>		<p>Indicates DC (Direct Current).</p>
	<p>Indicates that the instrument may be connected to or disconnected from a live conductor.</p>		<p>Indicates a grounding terminal.</p>
	<p>Indicates a instrument that has been protected throughout by double insulation or reinforced insulation.</p>		<p>Indicates that the product incorporates wireless communication function.</p>

Symbols for various standards

	<p>Indicates the Waste Electrical and Electronic Equipment Directive (WEEE Directive) in EU member states.</p>		<p>Indicates that the product conforms to regulations set out by the EU Directive.</p>
---	--	---	--

Measurement categories

WARNING



To prevent an electric shock, do not exceed the lower of the ratings shown on the instrument and connecting cords.

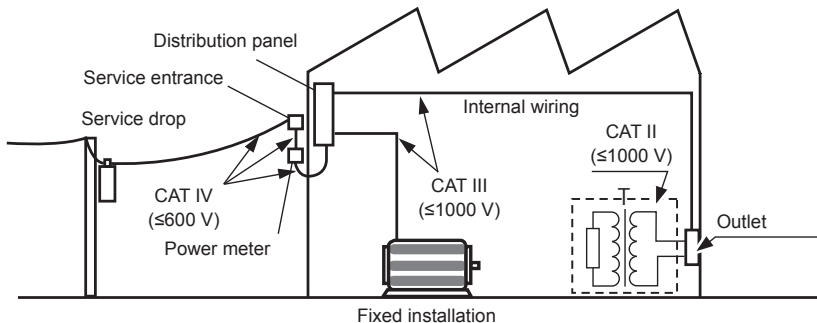

Precautions for Use

Follow these precautions to ensure safe operation and to obtain the full benefits of the various functions.

DANGER

- Do not use the instrument with circuits that exceed its ratings or specifications. Doing so may damage the instrument or cause it to become hot, resulting in bodily injury.

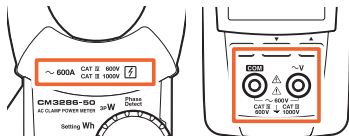

- The instrument must not be used to measure current in high-voltage lines (1000 V or more). Attempting to do so could cause a short-circuit or accident resulting in injury or death. Also, do not perform measurement around a bare conductor.
- To prevent an electric shock, do not touch any areas beyond the barrier while the instrument is in use.

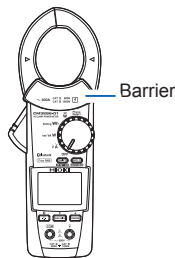

 **DANGER**



- Do not short-circuit two wires to be measured by bringing the clip or jaw tip of the connecting cords into contact with them. Arcs or such grave accidents are likely to occur.
- To prevent an electric shock, be careful to avoid shorting live lines with the connecting cords tip.
- To prevent a short-circuit or an electric shock, do not touch the metal part of the connecting cords tip.
- The maximum measurement current varies with the frequency, and the current that can be measured continuously is limited. Operating the instrument at less than this limitation is referred to as derating. Do not measure currents in excess of the derating curve. Doing so may result in instrument damage or malfunction, a fire, or a burn due to sensor heating.



It is recommended to make measurements on the secondary side of the distribution panel. Making measurements on the primary side of the panel, where currents are higher, poses a higher risk of instrument or equipment damage in the event of a short-circuit.

 **WARNING**

- **Installing the instrument in inappropriate locations may cause a malfunction of instrument or may give rise to an accident. Avoid the following locations.**
 - **Exposed to direct sunlight or high temperature**
 - **Exposed to corrosive or combustible gases**
 - **Exposed to a strong electromagnetic field or electrostatic charge**
 - **Near induction heating systems (such as high-frequency induction heating systems and IH cooking equipment)**
 - **Susceptible to vibration**
 - **Exposed to water, oil, chemicals, or solvents**
 - **Exposed to high humidity or condensation**
 - **Exposed to high quantities of dust particles**



- **Use only the specified connection cords. Use of any connection cord not specified by our company does not allow safe measurements.**
- **Options may include connection cords which uses sleeves. To prevent a short-circuit accident, be sure to use the connection cords with the sleeves attached when performing measurements in the CAT III or CAT IV measurement categories. (For measurement categories, see p. 10.)**
- **If the sleeves are removed during measurement, stop the measurement.**

 **CAUTION**



- To avoid damage to the instrument, protect it from physical shock when transporting and handling it. Be especially careful to avoid physical shock due to dropping it.
- Do not place foreign objects between jaws or insert foreign objects into the gaps of the sensor head. Doing so may worsen the performances of the sensor or interfere with clamping action.
- Do not get the instrument wet or operate it if your hands are wet. Doing so may cause electric shock.



- Keep the jaw closed when not in use, to avoid accumulating dust or dirt on the facing core surfaces, which could interfere with clamp performance.
- The cord is hardened in freezing temperature. Do not bend or pull it to avoid tearing its shield or cutting cord.

IMPORTANT

Inverter secondary-side waveforms and waveforms that include a large noise component may not be measured accurately.

Current measurement precautions

Do not touch.



**Do not clamp
around two wires.**



**Do not pinch wire
between jaws.**

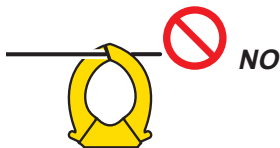

**Do not input
excessively high
currents or voltages.**



Part Names

Front

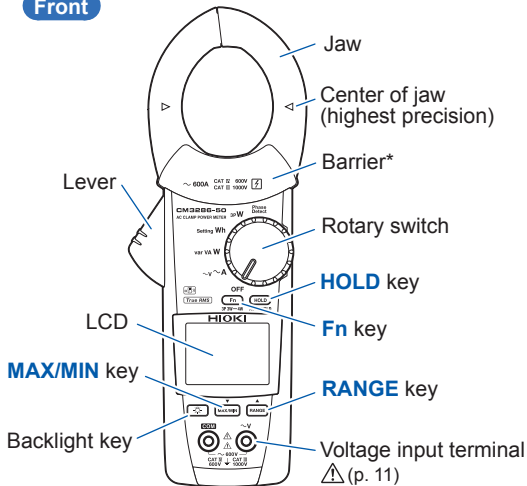

* Do not touch any areas beyond the barrier while the instrument is in use.

Rear

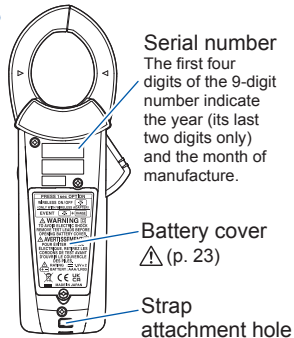

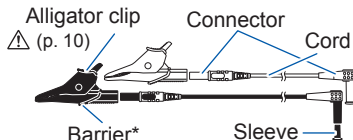

L9257 Connection Cord



Operation Keys

Key	Short press	Press and hold (1 s or longer)	
<div style="border: 1px solid black; border-radius: 10px; padding: 2px; display: inline-block;">HOLD</div> HOLD	Activates/cancels manual hold operation	p. 57	
	Start/stop integration, clears the integrated energy value (during energy measurement)	p. 50	
	Switches the setting (when setting meter constants)	p. 55	
	Switches from the connection display to the measurement display (during 3-phase power measurement)	p. 31	
<div style="border: 1px solid black; border-radius: 10px; padding: 2px; display: inline-block;">Fn</div> Fn	Switches the information shown on the measurement display	p. 33	
<div style="border: 1px solid black; border-radius: 10px; padding: 2px; display: inline-block;">RANGE</div> RANGE	Switches ranges	p. 60	
	Count up (when setting meter constants)	p. 55	
		Activates/cancels automatic hold operation	p. 57
		Switches between 3-phase/3-wire and 3-phase/4-wire measurement during 3-phase power measurement (setting is not stored)	p. 43 p. 44
		High speed count up (when setting meter constants)	–

Operation Keys

Key	Short press		Press and hold (1 s or longer)	
 MAX/MIN	Displays and switches MAX/MIN/AVG value	p. 61	Cancels the display of MAX/MIN/AVG value	p. 61
	Count down (when setting meter constants)	p. 55	High speed count down (when setting meter constants)	–
 Backlight	Toggles the display backlight on and off	p. 64	Enables/disables the wireless communications function (When connected to the Z3210, records settings.)	p. 66

Rotary switch

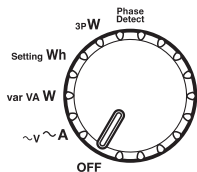

















When functions other than **OFF** is selected, the instrument turns on. Select the desired function.

Phase Detect	“Phase Detection [Phase Detect]” (p. 47)
3PW	<ul style="list-style-type: none"> • “AC 3-phase measurement (3P3W, balanced) [3PW]” (p. 40) • “AC 3-phase measurement (3P3W, unbalanced) [3PW]” (p. 41) • “AC 3-phase measurement (3P4W, balanced) [3PW]” (p. 43) • “AC 3-phase measurement (3P4W, unbalanced) [3PW]” (p. 44)
Setting Wh	<ul style="list-style-type: none"> • “Single-phase Active Energy Measurement (Integrated Measurement) [Setting Wh]” (p. 49) • “Single-phase Energy Meter Comparison Function [Setting Wh]” (p. 51)
var VA W	<ul style="list-style-type: none"> • “AC single-phase measurement (1P2W) [var VA W]” (p. 38) • “AC single-phase measurement (1P3W) [var VA W]” (p. 39)
~v~A	“Current/Voltage Measurement (Frequency) [$\tilde{v} \tilde{A}$]” (p. 37)
OFF	Turns off the instrument.

Power-on option table (beeping, resetting the instrument to the factory settings, etc.)

+  Turn on the power while pressing the operation key.
(Turn the rotary switch from the OFF position.)

Setting	See	Procedure	Factory-shipped setting	Saving of setting
Switching the auto power save (APS) function	p. 64	 + 	On	–
Displaying product information or displaying all indicators (Display varies depending on the position of the rotary switch.)	–	 +  3PW: Serial number Wh: Model number W: Version of software Besides the above: Displays all indicators	–	–
Switching between balanced and unbalanced operation (during AC 3-phase power measurement)	p. 41 p. 44	 + 	–	–
Beeping (on/off)	–	 + 	On	Saved





Setting	See	Procedure	Factory-shipped setting	Saving of setting
Switching the automatic backlight off function	p. 64	 + 	On	Saved
Selecting the CT ratio	p. 65	 +  + 	1/1	Saved
Reset to the factory shipped setting	–	 +  + 	–	–

Installing and Replacing Batteries

When using the instrument, install two LR03 Alkaline batteries.

Check that there is adequate remaining power in the batteries before starting the measurement.

If the instrument's batteries are running low, replace the batteries with fresh ones.

Battery level indicator	Battery status
 (Appears)	Fully charged.
 (Appears)	As the battery charge diminishes, black charge bars disappear, one by one, from the left of the battery indicator.
 (Appears)	The battery voltage is low. Replace the batteries as soon as possible.
 (Blinks)	The battery is exhausted. Replace with new batteries.

Battery installation/replacement procedure

WARNING



To prevent an electric shock, turn off the instrument and disconnect the instrument from the object under measurement before replacing the batteries.



- After replacing the batteries, reattach the cover and secure the screw before using the instrument.
- To prevent instrument damage or an electric shock, use only the screws that are originally installed for securing the battery cover in place. If you have lost a screw or find that a screw is damaged, please contact your authorized Hioki distributor or reseller.



Batteries may explode if mistreated. Do not short-circuit, recharge, or disassemble the batteries, or dispose of them in fire.

CAUTION

Poor performance or damage from battery leakage could result. Observe the cautions listed below.



- Do not mix old and new batteries, or different types of batteries.
- Pay attention to the polarity markings “+ –”, so that you do not insert the batteries the wrong way around
- Do not use batteries after their recommended expiry date.
- Do not leave depleted batteries inside the instrument.
- Remove batteries from the instrument if it is to be stored for a long time.
- Replace batteries only with the specified type.

You will need: No. 2 Phillips screwdriver and LR03 Alkaline battery ×2
Recommended screw tightening torque: 0.7 N•m

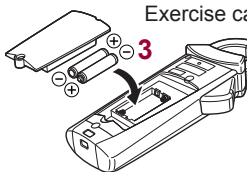
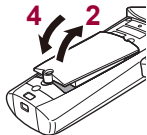
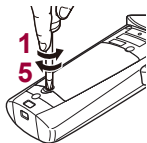

Exercise care to orient batteries properly.

Z3210 Wireless Adapter (option)

With the Z3210 Wireless Adapter installed to the instrument, the wireless communications function can be used.(p. 66)

WARNING



To prevent an electric shock, turn off the instrument and disconnect the instrument from the object under measurement before connecting the Z3210.



- **After installing the Z3210, reattach the battery cover and secure the screws before using the instrument.**
- **To prevent instrument damage or an electric shock, use only the screws that are originally installed for securing the battery cover in place. If you have lost any screws or find that any screws are damaged, please contact your authorized Hioki distributor or reseller.**

CAUTION



Before handling the Z3210, eliminate static electricity from your body by touching any metallic part, such as a doorknob. Failure to do so could cause static electricity to damage the Z3210.

Z3210 Wireless Adapter installation/replacement procedure

You will need:

- Z3210 Wireless Adapter (option)
- Phillips screwdriver (No. 2)

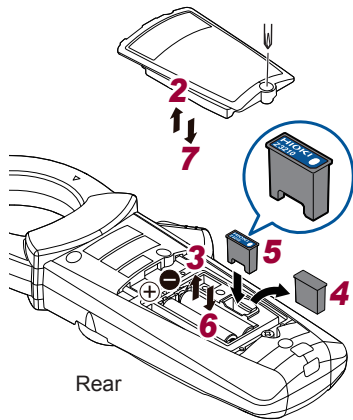

- 1** Remove the instrument from the object under measurement and turn off the instrument.
- 2** Loosen the screw and remove the battery cover.
- 3** Remove the batteries.
- 4** Remove the protective cap.
- 5** Carefully checking the orientation, insert the 3210 all the way inside.
- 6** Install the batteries.
- 7** Install the battery cover and tighten the screw.

Recommended screw tightening torque: 0.7 N·m

Test Leads

The optional L9300 Test lead or L9207-10 Test Lead can be used for measurement. Depending on measurement locations, use our optional measurement cables. See “Options” (p. 5).

L9300 Test Lead



For measurement in category III, IV



For measurement in category II

L9207-10 Test Lead

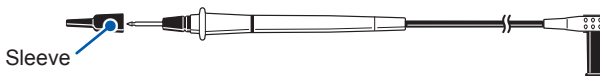

Sleeve

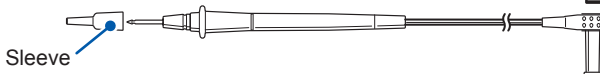

Sleeve

L9300 Test Lead

WARNING



To prevent a short-circuit accident when making CAT III or CAT IV measurements, rotate so that you can see the measurement category label that is appropriate for the circuit under measurement.

The measurement category display changes when the protective finger guard is slid.

For measurement in category III, IV

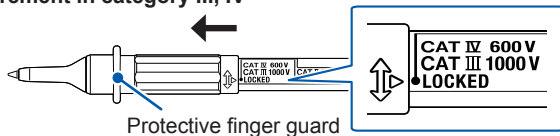

For measurement in category II

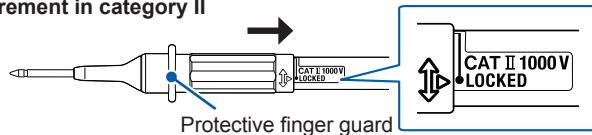

L9207-10 Test Lead

 **WARNING**

- To prevent a short-circuit accident, be sure to use the test leads with the sleeves attached when performing measurements in the CAT III and CAT IV measurement categories. (For measurement categories, see p. 10.)
- If the sleeves are removed during measurement, stop the measurement.

Attaching and removing the sleeve changes the measurement category.

For measurement in category III, IV



➔ Attaching the sleeve

Insert the metal pins of the test leads into the holes of the sleeves, and firmly push them all the way in.

For measurement in category II



← Removing the sleeve

Grip the base of the sleeves and pull the sleeves off. Store removed sleeves for future use.

Inspection Before Measurement

Check the instrument for any damage that may have occurred during storage or shipping, and perform functional checks before use. If you find any damage to the instrument, please contact your authorized Hioki distributor or reseller for repair.

Check item	
<input type="checkbox"/>	The battery cover is closed and its screw has been securely tightened.
<input type="checkbox"/>	There is no foreign matter on the voltage input terminals. (p. 16)
<input type="checkbox"/>	The battery voltage (p. 22) is sufficient.
<input type="checkbox"/>	There is no damage to the connection cords insulation, and neither the white sheathing nor metal conductor inside the wire are exposed.
<input type="checkbox"/>	The instrument is neither damaged nor cracked.
<input type="checkbox"/>	No indicators are missing. (Check by verifying that all the indicators are displayed.)

Fn + [Rotary Switch] →
OFF → ~V ~A

RANGE: MANUAL CT 1/1000 %
 3P3W 3P4W PF 88.88 %
 UNBALANCED kVA
 HOLD | PEAK | MAX | MIN | AVG THD-R
 PF 88.88 var
 OVER EVENT 88.88 Hz
 MEASURED EXPECTED
 h:m 88.88 cyc./ 88.88 | PEAK |
 m:s 88.88 kVA/ 88.88 kWAs

Screen, Basic Operation

Setting the rotary switch to a position other than **OFF** causes the instrument to turn on and the screen to activate. e.g.: During balanced 3-phase 3-wire active power measurement

Connection display

Displays the connection locations for 3-phase power measurement and phase detection. Connects the wire.

Wire around which to clamp instrument

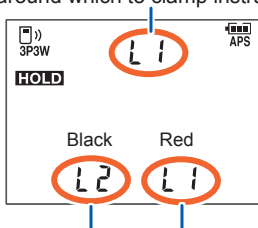

Wires to which to clip connection cords

Measurement display

Displays the measured value.

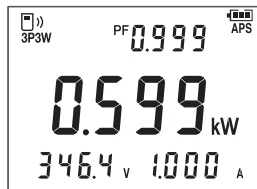

IMPORTANT

If measured with a wrong wire connection, a correct value does not appear.

Screen display

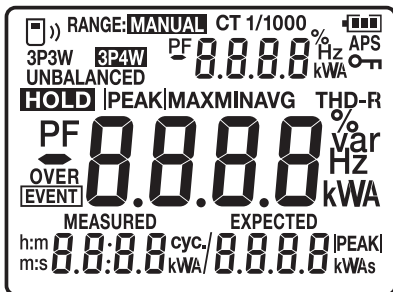



(All indicators displayed)

“Error and operational displays” (p. 105)

“Warning display” (p. 106)

*: The key lock feature may be activated according to the usage state of the application software.

Display	Description
	On: Wireless communications function enabled Blinking: Now communicating (with Z3210 connected)
3P3W, 3P4W	Connection type (not shown during single-phase measurement)
UNBALANCED	Unbalanced mode operation (not shown during balanced mode operation)
RANGE: MANUAL	Manual range operation (not shown during automatic-range operation)
CT 1/1000	CT ratio (not shown during 1/1)
HOLD	Measured value held
APS	Auto power save enabled
OVER	Current RMS value or voltage RMS value exceeded range
	Key lock enabled*

Switching the information shown on the measurement display

Able to switch using the **Fn** key (Excluding the Setting **Wh** and **Phase Detect** functions).

How to use this chart:

(Sub1 display) $FREQ_U$	
(Main display) I_{RMS}	
(Sub2 display) -	(Sub3 display) $I_{ PEAK }$

Rotary switch	Current ← SHIFT → Voltage	
Current (frequency)	$FREQ_I$	$FREQ_U$
Voltage (frequency)	I_{RMS}	U_{RMS}
\tilde{V} \tilde{A}	- $I_{ PEAK }$	- $U_{ PEAK }$

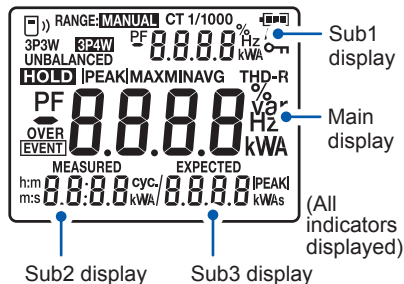

$FREQ_I$: Current frequency

I_{RMS} : Current RMS value

$I_{|PEAK|}$: Current peak value

$FREQ_U$: Voltage frequency

U_{RMS} : Voltage RMS value

$U_{|PEAK|}$: Voltage peak value

Screen, Basic Operation

Rotary switch		Active power—Apparent power—Reactive power—Power factor—Zero-cross phase angle									
		(Main display) 									
Voltage/Power factor var VA W		PF		PF		PF		P		P	
		P		S		Q		PF		ϕ	
		U_{RMS}	I_{RMS}	U_{RMS}	I_{RMS}	U_{RMS}	I_{RMS}	U_{RMS}	I_{RMS}	U_{RMS}	I_{RMS}
3P W	Balance mode*1	PF^{*2}		PF^{*2}		PF^{*2}		P_{3P}		P_{3P}	
		P_{3P}		S_{3P}		Q_{3P}		PF_{3P}^{*2}		ϕ_{3P}^{*2}	
		U_{RMS}	I_{RMS}	U_{RMS}	I_{RMS}	U_{RMS}	I_{RMS}	U_{RMS}	I_{RMS}	U_{RMS}	I_{RMS}
	Unbalance mode*3	P_3		S_3		Q_3		PF_3		ϕ_3	
		$P_1+P_2+P_3$		$S_1+S_2+S_3$		$Q_1+Q_2+Q_3$		$\frac{P_1+P_2+P_3}{S_1+S_2+S_3}$		-	
		P_1	P_2	S_1	S_2	Q_1	Q_2	PF_1	PF_2	ϕ_1	ϕ_2

P : Single-phase active power

S : Single-phase apparent power

Q : Single-phase reactive power

PF : Power factor

ϕ_1 : Zero-cross phase angle 1

P_1 : Active power 1

S_1 : Apparent power 1

Q_1 : Reactive power 1

PF_1 : Power factor 1

ϕ_2 : Zero-cross phase angle 2

P_2 : Active power 2

S_2 : Apparent power 2

Q_2 : Reactive power 2

PF_2 : Power factor 2

ϕ_3 : Zero-cross phase angle 3

P_3 : Active power 3

S_3 : Apparent power 3

Q_3 : Reactive power 3

PF_3 : Power factor 3

P_{3p} : Balanced 3-phase active power

S_{3p} : Balanced 3-phase apparent power

Q_{3p} : Balanced 3-phase reactive power

PF_{3p} : Balanced 3-phase power factor

ϕ : Zero-cross phase angle

$P_1+P_2+P_3$: Unbalanced 3-phase active power

$S_1+S_2+S_3$: Unbalanced 3-phase apparent power

$Q_1+Q_2+Q_3$: Unbalanced 3-phase reactive power

$\frac{P_1+P_2+P_3}{S_1+S_2+S_3}$: Unbalanced 3-phase power factor

ϕ_{3p} : 3-phase zero-cross phase angle

Notes(*) for table

*1: Value of the measured phase will be calculated and displayed.

*2: Different calculation methods are used for 3-phase/3-wire and 3-phase/4-wire circuits. For more information, see the list of equations.

*3: Only 3-phase active power (P_1+P_2), active power 1 (P_1), and active power 2 (P_2) are measured for 3-phase/3-wire circuits.

—	
P_1+P_2	
P_1	P_2

Connecting the Clamp and Clips

Clamp

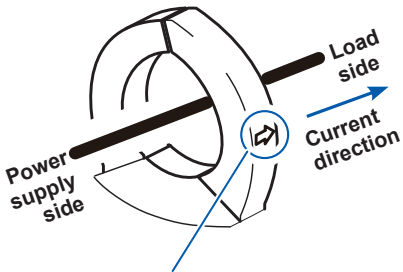

Orient the clamp so that the arrow points towards the load.

Clip (Alligator)

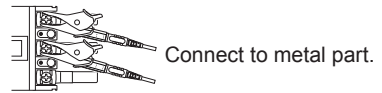

Clip (Magnetic adapter)

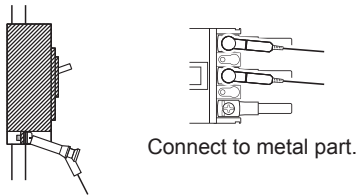

If unable to connect the magnetic adapter so that it sits perpendicular to the terminal due to the weight of the voltage cord, connect it at an angle so as to balance it against the weight of the cord.

Current/Voltage Measurement (Frequency) [\tilde{V} \tilde{A}]

- 1** Select the desired function.



*: **Fn**

“Switching the information shown on the measurement display” (p. 33)

If the screen turns red:
“Warning display” (p. 106)

The frequency display flashes when frequency exceeds 999.9 Hz.

Current measurement

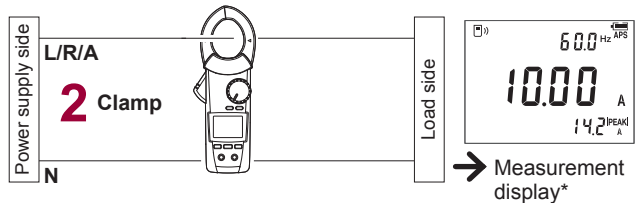

Voltage measurement

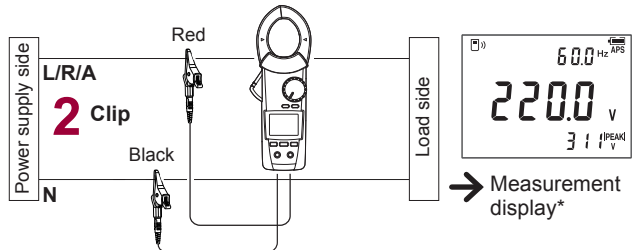

Power Measurement (Power, Power Factor)

AC single-phase measurement (1P2W) [var VA W]

1 Select the desired function.



*: **Fn**

“Switching the information shown on the measurement display” (p. 33)

If the screen turns red: “Warning display” (p. 106)

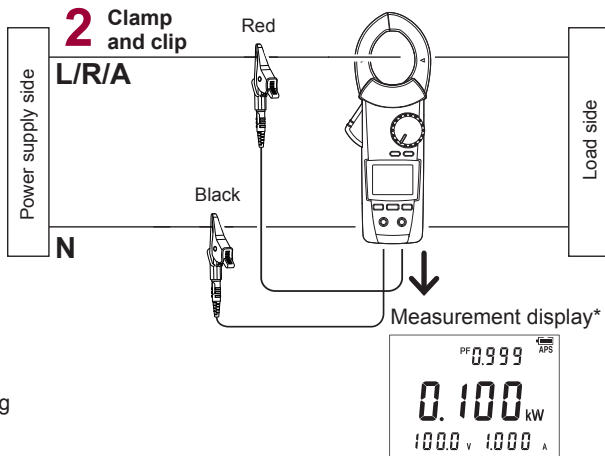

AC single-phase measurement (1P3W) [var VA W]

1 Select the desired function.

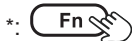

“Switching the information shown on the measurement display” (p. 33)

If the screen turns red: “Warning display” (p. 106)

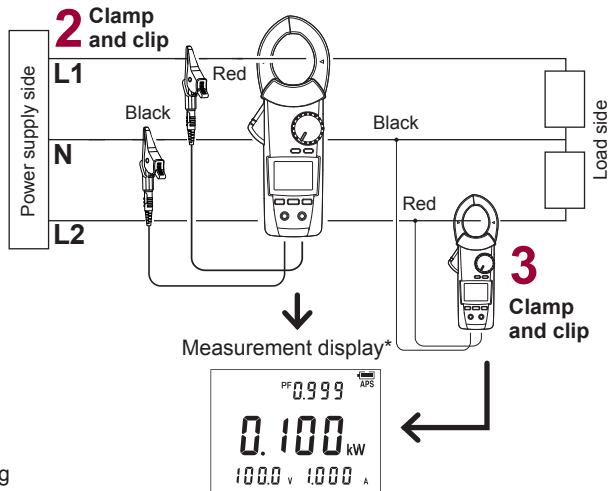

AC 3-phase measurement (3P3W, balanced) [3PW]

1 Select the desired function.



Connection display (p. 31)

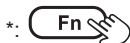
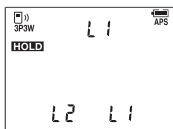

“Switching the information shown on the measurement display” (p. 33)

If the screen turns red: “Warning display” (p. 106)

When the balanced 3-phase 3-wire zero-cross phase angle is less than -90° or exceeds 90° , the measured value appears “-----”.

2 Clamp and clip

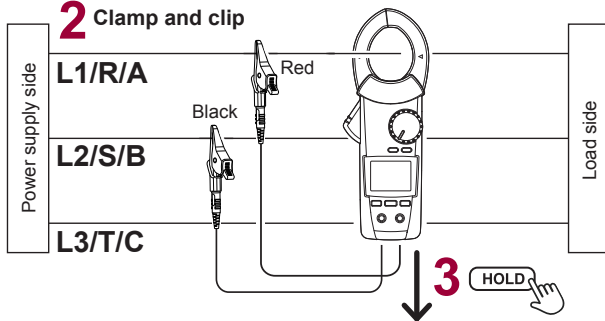

3 Measurement display (calculation result)*



AC 3-phase measurement (3P3W, unbalanced) [3PW]

1 Select the desired function.



Set the rotary switch to other than the OFF position.



Connection display 1 (p. 31)

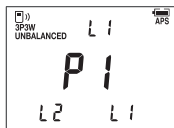

- Proceed to the next step after verifying that the measured values shown on measurement displays 1 and 2 are normal.
- If the screen turns red: "Warning display" (p. 106)

2 Clamp and clip

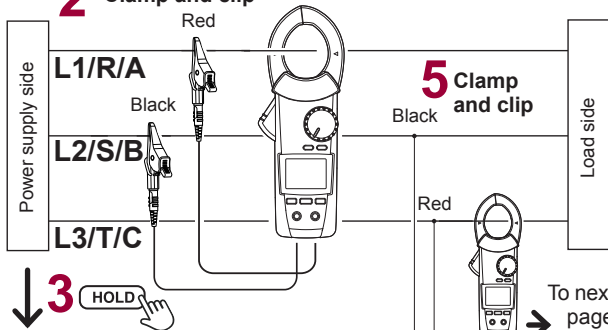

Measurement display 1 (active power 1)

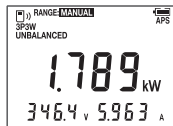

To next page

↑ Connection display 2

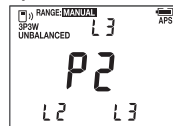

Power Measurement (Power, Power Factor)

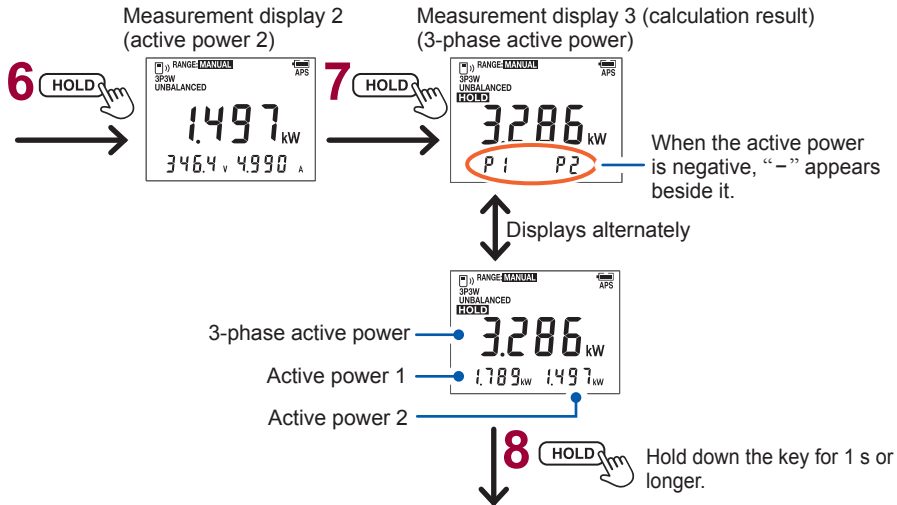

The measured value is cleared and returns to the initial connection display.

AC 3-phase measurement (3P4W, balanced) [3PW]

1 Select the desired function.

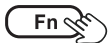
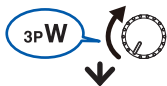

Hold down the key for 1 s or longer.

Connection display (p. 31)

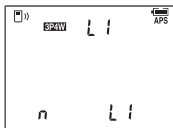

2 Clamp and clip

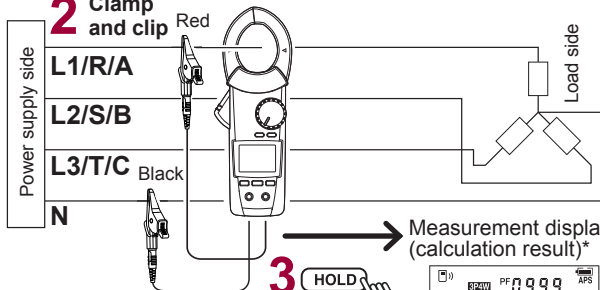

3 HOLD

Measurement display (calculation result)*



If the screen turns red:
"Warning display" (p. 106)

*:  "Switching the information shown on the measurement display" (p. 33)

AC 3-phase measurement (3P4W, unbalanced) [3PW]

1 Select the desired function.



Set the rotary switch to other than the OFF position.

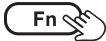

Hold down the key for 1 s or longer.

Connection display 1 (p. 31)

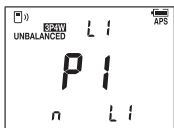

Proceed to the next step after verifying that the measured values shown on measurement display 1 is normal.

2 Clamp and clip

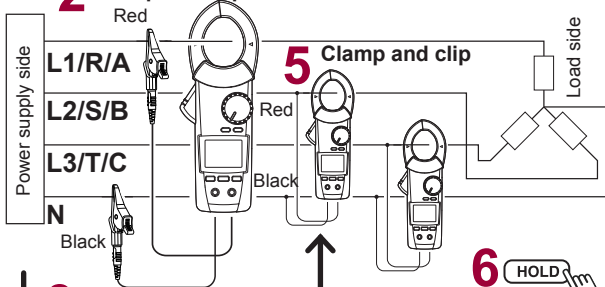

3 HOLD

Measurement display 1 (active power 1)

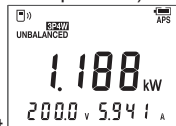

4 HOLD

Connection display 2

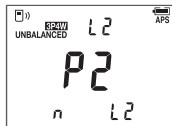

6 HOLD

To next page

Power Measurement (Power, Power Factor)

Measurement display 2
(active power 2)

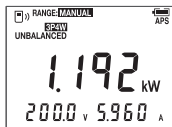

Connection display 3

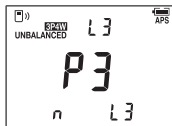

→ To 8

Proceed to the next step after verifying that the measured values shown on measurement displays 2 and 3 are normal.

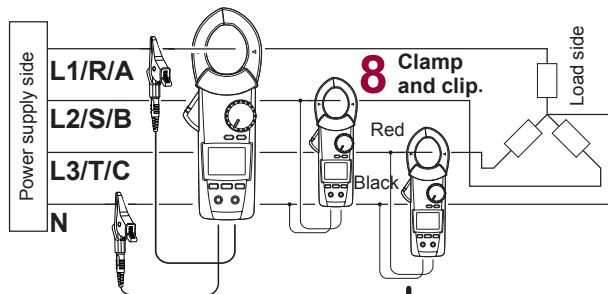

Measurement display 3
(active power 3)

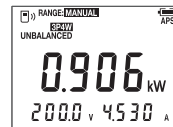

→ To next page

Power Measurement (Power, Power Factor)

Measurement display 4 (calculation result)
(3-phase active power)

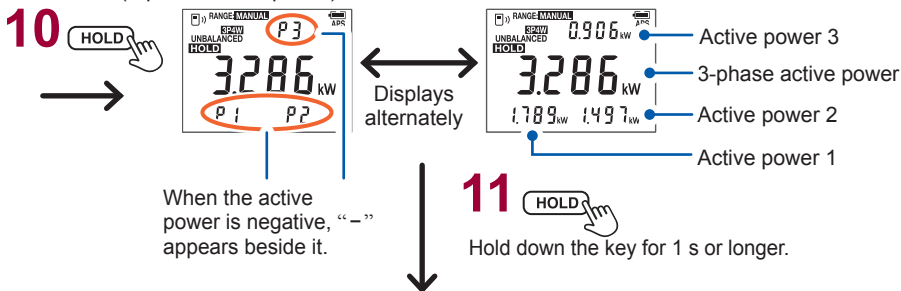

The measured value is cleared and returns to the initial connection display.

- You can switch the information shown on the final measurement display with the **Fn** key. See “Switching the information shown on the measurement display” (p. 33)
- If the screen turns red: “Warning display” (p. 106)

Phase Detection [Phase Detect]

1 Select the desired function.



Connection display (p. 31)

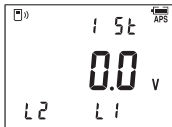

- The instrument will display “----” if open phase is detected or if it is unable to make a measurement.
- When the input is unstable, the second connection display will not show up.

*: If not clipped within 10 s, it is unable to make a measurement.

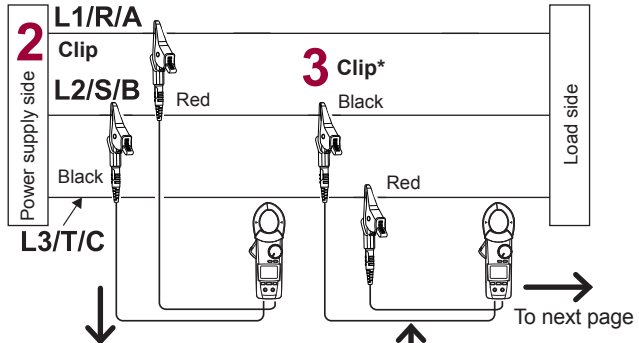

Measurement display

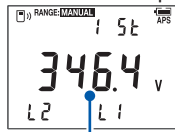

Line voltage (1st measurement)



Connection display

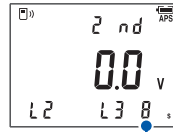

Countdown display

Phase Detection [Phase Detect]

Measurement display

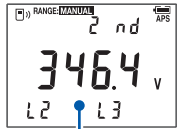

Line voltage (2nd measurement)

→ Display of results

Normal phase

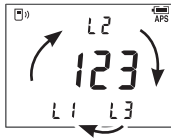

Reverse phase



(Lights red)

Display appears in the order of the arrow.

Goes back to the first display when the **HOLD** key is pressed.

Single-phase Active Energy Measurement (Integrated Measurement) [Setting Wh]

- 1** Select the desired function.



- 2** Set the constant number to OFF.

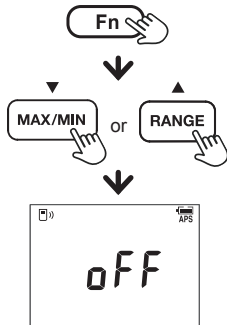

- 3** Clamp and clip

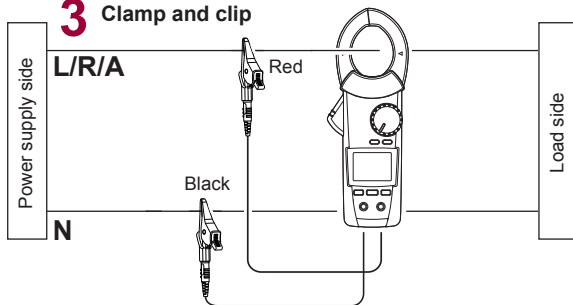

→
To next page

Single-phase Active Energy Measurement (Integrated Measurement) [Setting Wh]

4 Set the instrument to power integration mode.

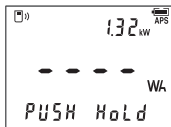

5 Start integration.

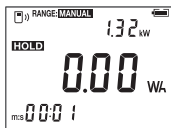

- Range is fixed when integration starts. Change the range before starting to integrate a large power quantity or for an extended period of time.
- Only the positive (consumption) active power is added. Negative (generation) active power is not added.

6 Stop integration.

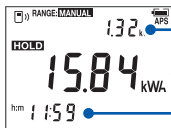

Single-phase active power

Single-phase active energy

Elapsed time

- When the **HOLD** key is pressed during integration stop, the integrated energy clears and returns to the display shown in Step 4.
- The measured values are automatically stored just before the instrument turns off due to low battery voltage. Next time the instrument is turned on, the saved values will be displayed. (The measured values can be cleared by pressing the **HOLD** key.)

Single-phase Energy Meter Comparison Function [Setting Wh]

This function allows you to compare the actual energy value (measured value) from an energy meter with the theoretical value.

There are two ways to start and stop integration:

- Start/stop at 1 cycle based on the energy meter's instrument constant: 1-cycle mode
- Start/stop based on a fixed amount of energy as measured by the energy meter: Fixed energy mode

IMPORTANT

Energy may not be calculated properly in the following circumstances:

- If the power line of the measurement object, instrument connection, or meter constant (for the watt-hour meter) is set incorrectly.
- If integration is not started and stopped as described above.
- If the instrument is being used outside its operating temperature and humidity range.
- If the instrument is being used in close proximity to a device that emits powerful electromagnetic radiation or a device that carries an electrical charge.
- If the instrument is being used in close proximity to a device that emits a strong magnetic field, for example a transformer, high-current circuit, or wireless device.

Single-phase Energy Meter Comparison Function [Setting Wh]

1-cycle mode

Mechanical meter

Once the disc has completed one revolution

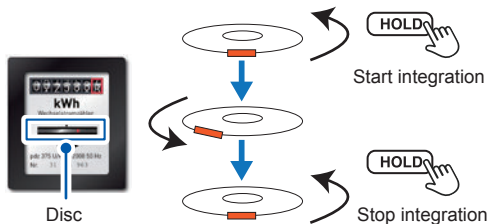

Electronic meter

When the LED flashes once

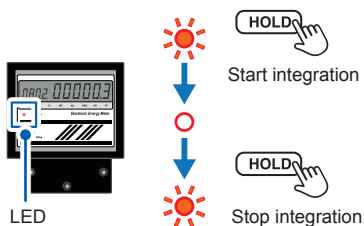

Fixed energy mode

e.g.: With the fixed energy set to 0.1 kWh

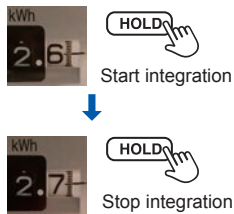
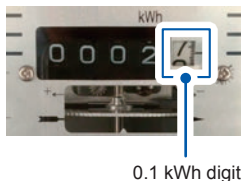

1 Select the desired function.



2 Select the constant number or fixed energy*.

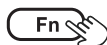

or

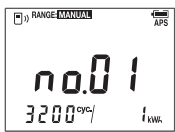

3 Clamp and clip

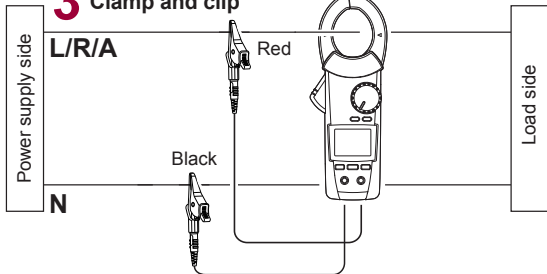

→
To next page

*: Select fixed energy mode if the energy meter's disc rotates, or if its LED flashes, quickly.

The constant can be changed.

“Energy meter comparison function settings screen” (p. 56)

“Setting the desired meter constant” (p. 55)

Single-phase Energy Meter Comparison Function [Setting Wh]

4 Set the instrument to power integration mode.

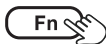

5 Start integration.



6 Stop integration.

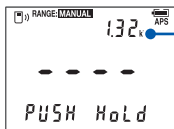

Single-phase active power (measured value)

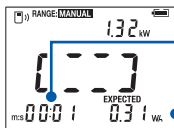

Elapsed time

Energy (theoretical value)

- Only the positive (consumption) active power is added. Negative (generation) active power is not added.
- Range is fixed when integration starts. Change the range before starting to integrate a large power quantity or for an extended period of time.

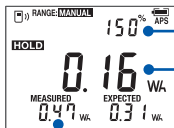

Energy ratio (Measured value / theoretical value)

Energy difference
(Measured value – theoretical value)

Energy (Measured value)

When the **HOLD** key is pressed during integration stop, the integrated energy clears and returns to the display shown in Step 4.

Setting the desired meter constant

Set after conducting the procedures 1 and 2 of “Single-phase Energy Meter Comparison Function [Setting Wh]” (p. 51).

- 1** Select the portion you wish to change. The selected portion will flash.



- 2** Change the value.

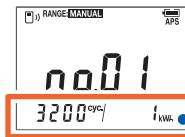

Set the value shown on the meter.

The set value will be stored.

- Press the **Fn** key to go back to the measurement display.
- The changed final value will be the setting value.
- “Energy meter comparison function settings screen” (p. 56)

Energy meter comparison function settings screen

No.01 to No.10: 1-cycle mode

0.10 kWh to 0.01 kWh: Fixed energy mode

✓: Enable, -: Disable

SET No. (main display)	Setting value	Changing the setting value	SET No. (main display)	Setting value	Changing the setting value
oFF	None (single-phase active power measurement)	None	no. 07	300 cyc./1 kWh	✓
no. 01	3200 cyc./1 kWh	✓	no. 08	250 cyc./1 kWh	✓
no. 02	1600 cyc./1 kWh	✓	no. 09	150 cyc./1 kWh	✓
no. 03	1200 cyc./1 kWh	✓	no. 10	125 cyc./1 kWh	✓
no. 04	1000 cyc./1 kWh	✓	0.10 kWh	0.10 kWh	-
no. 05	600 cyc./1 kWh	✓	0.05 kWh	0.05 kWh	-
no. 06	500 cyc./1 kWh	✓	0.01 kWh	0.01 kWh	-

Manual Hold, Automatic Hold

Manual hold

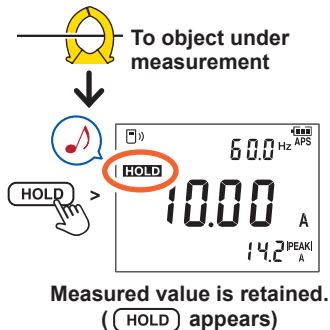

Pressing the **HOLD** key again cancels the measured value hold function.

(**HOLD** and **HOLD** disappear)

Automatic hold

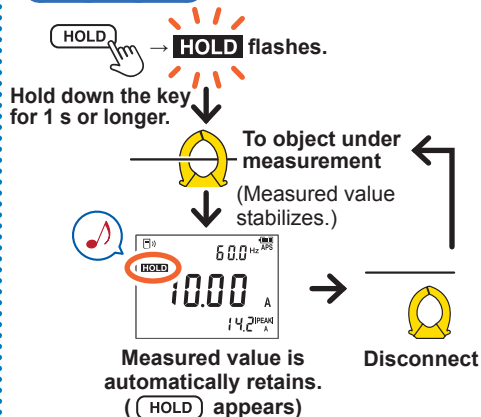

Holding down the **HOLD** key for 1 s to disable the automatic hold function. (**HOLD** and **HOLD** disappear). See the next page for automatic hold conditions.

Automatic hold conditions

Measured value is automatically retained when the following two conditions are satisfied:

- When the range over which the measured value is fluctuating stabilizes within the fluctuation range described in the table .
- When the measured value exceeds the threshold value described in the table .

O: Held value

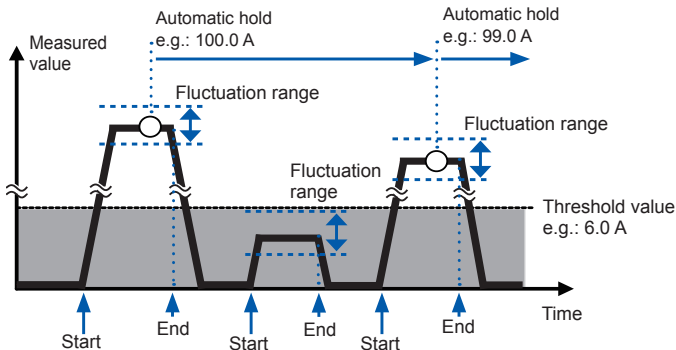

If the measured value* (voltage, current, or power) falls below the threshold value once and the two conditions are satisfied again after automatic retaining, the measured value at that point will retain automatically.

*: Either the current RMS value or voltage RMS value for power.

Measurement function*	Fluctuation range	Threshold value
AC current	Current RMS value 6.000 A range: within 60 counts 60.00 A range: within 60 counts 600.0 A range: within 60 counts	Current RMS value 6.000 A range: 59 counts 60.00 A range: 59 counts 600.0 A range: 59 counts
AC voltage	Voltage RMS value within 120 counts	Voltage RMS value 799 counts
Single-phase power, balanced 3-phase power	Current and voltage RMS values satisfy above conditions, and active power is within 5 counts.	Current and voltage RMS values are within the above counts.

*: No automatic hold function is available for single-phase active energy measurement.

Switching Ranges

e.g.: During current measurement

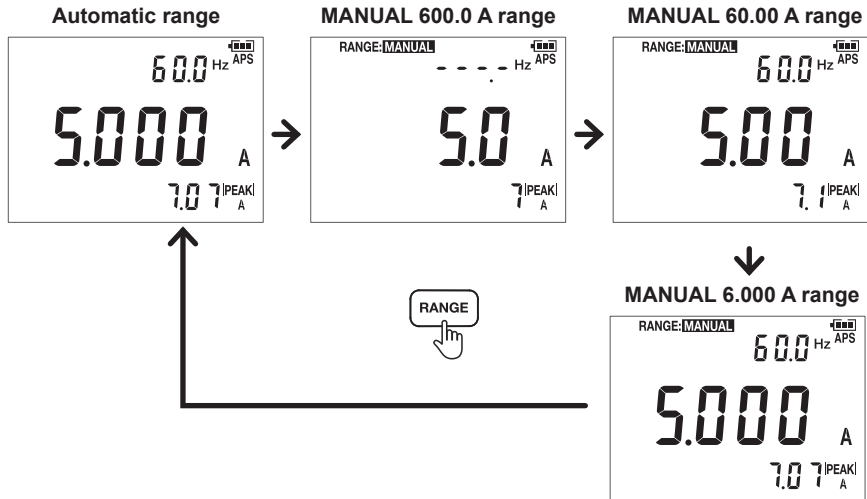

Max., Min., and Average Values (MAX/MIN/AVG)

1  To object under measurement

2  Present value → MAX → MIN → AVG



 : To switch the main display.

 (Hold down for 1 s or longer.) or  (switching functions): MAX/MIN/AVG measurement function is cleared.

- Switches to manual range when it is automatic range. (RANGE:MANUAL appears)
- The maximum, minimum, and average measurement will be continued during hold function.
- The maximum, minimum, and average function cannot be used during Wh function and phase detect function operation.
- The maximum and minimum values are automatically stored just before the instrument turns off due to low battery voltage. Next time the instrument is turned on, the saved values will be displayed. (The measured values can be cleared by pressing the **HOLD** key.)

Max., Min., and Average Values (MAX/MIN/AVG)

e.g.: **During current measurement**

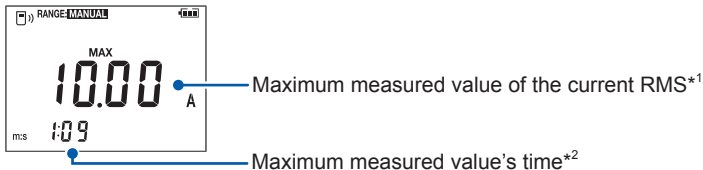

*1: The maximum, minimum, and average values for the main display's measured value is shown.

(However, only the maximum and average values are shown during peak value measurement.

Also, only the maximum and minimum values are shown during zero-cross phase angle measurement.)

*2: Measured value's update time is displayed when maximum or minimum value is shown.

Elapsed time from the start of maximum, minimum, and average function is displayed when present or average value is shown.

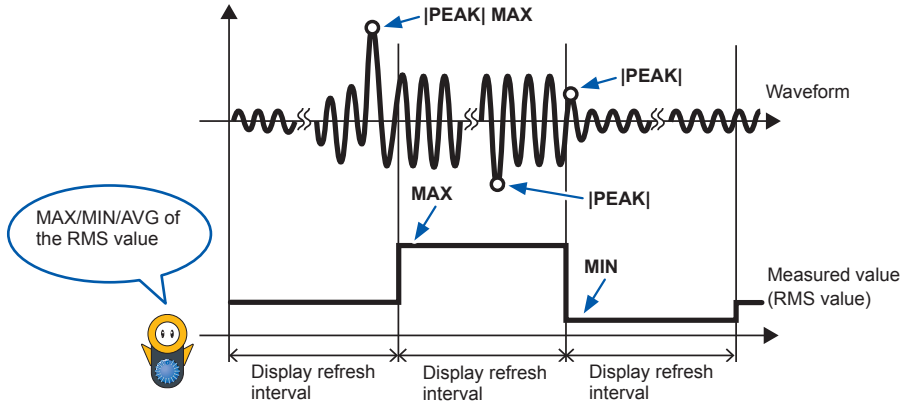

AVG: Average value after pressing the **MAX/MIN** key

MAX: Maximum value after pressing the **MAX/MIN** key

MIN: Minimum value after pressing the **MAX/MIN** key

|PEAK|: Maximum value of the absolute value of the waveform during the display update interval

|PEAK| MAX: Minimum value of |PEAK| after pressing the **MAX/MIN** key

Backlight, Automatic Power Save (APS)

Backlight

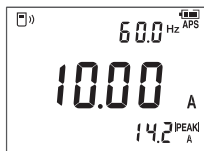

Backlight OFF

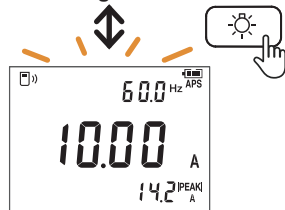

Backlight ON

No operation for approx. 40 s:
Backlight off

Switching the auto backlight off
function: p. 21

Automatic power save (APS)

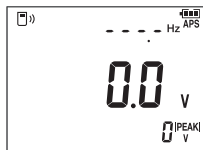

(Ordinarily ON)
Switching the
function: p. 20

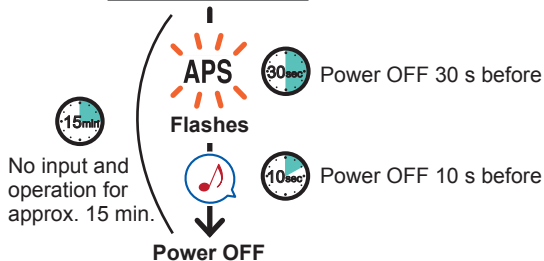

- Set the rotary switch to OFF when restarting the instrument after the APS function.
- The APS function is disabled while displaying the MAX/MIN/AVG value and during energy integration.
- Wireless communications are considered to be in operation and do not correspond to no operation.

Measurement Using the Clamp Adapter

A clamp adapter (option) can be used to measure currents that are larger than the rated input current.

1 Select the CT ratio.

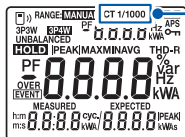

Rotary switch	CT ratio
A	1/1 (not shown)
W	1/10
Wh	1/100
3PW	1/1000

Set the CT ratio as appropriate for the clamp adapter.
(e.g.: For the 9290-10 Clamp on Adapter, 1/10)

3 Clamp

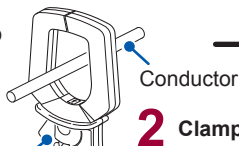

2 Clamp

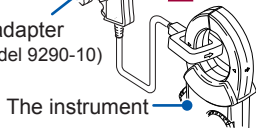

4 Perform measurement.

Wireless Communications Function

Installing the Z3210 Wireless Adapter (optional) is required.
Concurrent use of GENNECT Cross and HID function (p. 71) is not available.

GENNECT Cross (application software)

Enabling the wireless communications function allows you to check the measured data of the instrument, and create measurement reports using your mobile device.
For details, see the operation guide for the GENNECT Cross app (free of charge).

GENNECT Cross special site

<https://gennect.net/en/cross/index>



- The communication distance is about 10 m with a clear line of sight. The communicable distance may vary greatly depending on the presence of an obstruction (wall or metallic shielding object) and the distance between the floor (ground) and instrument. To ensure the stable communication, make sure that the radio wave intensity is sufficient.
- GENNECT Cross is free of charge. However, the customer is responsible for the cost to download the application software and connect to the Internet when using the software.
- GENNECT Cross may not operate properly depending on the mobile device.
- The Z3210 uses the 2.4 GHz band wireless technology. When there is a device that uses the same frequency band such as a wireless LAN (IEEE 802.11.b/g/n) near your mobile device, the communication may not be established.
- At the time of initial startup (with no device registered), GENNECT Cross starts up with the Instrument Settings screen.
- When the instrument is nearby, it is automatically connected and registered in the connection setting screen (up to 8 devices).
- Wait for 5 to 30 seconds for the instrument to be connected and registered after turning on the power to the instrument. If the instrument is not registered after 1 minute, restart GENNECT Cross and the instrument.
- When you turn on the instrument for the first time after installing the Z3210, the instrument will start with the wireless communications function enabled. The setting will be retained even after power off.

Using the wireless communications function

- 1** Connect the Z3210 Wireless Adapter into the instrument. (p. 25)
- 2** Install GENNECT Cross on your mobile device.
- 3** Turn on the instrument.
- 4** Press and hold the backlight key to turn on the wireless communications function.

The display will show the  icon.



Hold down for 1 s.

- 5** Start GENNECT Cross and register the instrument to connect.
- 6** Select each function and perform measurement.

For detail information, please visit our website.

GENNECT Cross > Functions
<https://gennect.net/en/cross/function>



Turning on and off the wireless communications function

Wireless communications function OFF



Wireless communications function ON



Hold down the
key for 1 s or
longer.

The  icon will flash when the instrument is connected to a mobile device.



Event recording function (EVENT)

The event recording function logs the data when a measured value exceeds a desired threshold value, which can be set with GENNECT Cross. For details, see the operation guide for the GENNECT Cross app. The number of recorded events can be checked using the instrument.

1  +  Hold down the two keys for 1 s or longer.

2 Check the number of recorded events.

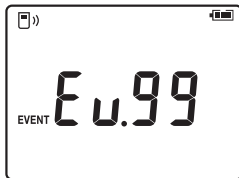

Up to 99 events can be recorded. If events has reached 99, the event recording will stops. When another event recording starts, previously recorded data will be deleted.

Some events with a duration time of less than 1 s may not be accurately measured, failing to detect them.

Z3210-to-Excel[®] direct data entry function (Excel[®] direct input function, HID function)

Concurrent use of GENNECT Cross and HID function is not available.

The human interface device (HID) profile, with which the Z3210 Wireless Adapter is equipped, is a profile same as that wireless keyboards use.

HID ON	Preparatory to data entry, open an Excel [®] file on your mobile device or computer and choose a cell. When the instrument's display freezes, the measured values will be entered on the cells. The use of this function with the automatic hold function enabled comes in handy. (p. 57)
HID OFF	When you wish to use GENNECT Cross, disable the HID function.

The setting whether the HID function has been enabled or disabled will not be saved in the instrument but in the Z3210.

Confirming the HID setting

The Z3210 Wireless Adapter needs to be installed. (p. 25)

- 1 Turn off the instrument.
- 2 Turn the rotary switch to the **Phase Detect** position with holding down the **Fn** key.

The HID setting saved in the Z3210 will be displayed.



- 3 Confirm the HID setting.

When the HID function is enabled

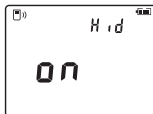

When the HID function is disabled

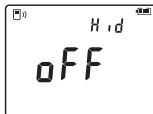

Release the **Fn** key.

Regular display reappears.

When “----” is displayed

Update the Z3210 to the latest version using GENNECT Cross.

Changing the HID setting

The Z3210 Wireless Adapter needs to be installed. (p. 25)

1 Turn off the instrument.

2 Turn the rotary switch to any position with holding down the backlight key and the **Fn** key.

The HID setting saved in the Z3210 will be displayed.

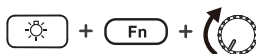

Set the rotary switch to other than the OFF position.

3 Change the HID setting.

After the setting is toggled between on and off, the instrument is automatically turned off.

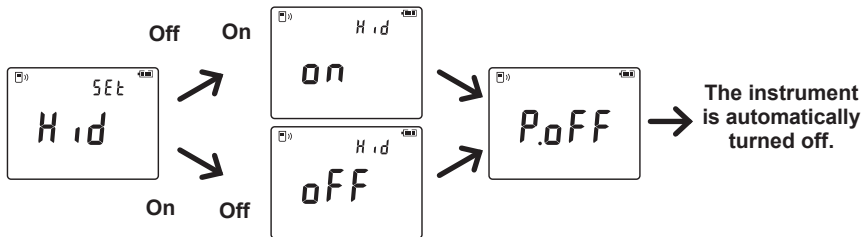

4 Turn on the instrument again.
The HID setting will be toggled.

IMPORTANT

To switch over from the HID function to GENNECT Cross

If you start GENNECT Cross without canceling the pairing between the mobile device and the instrument, GENNECT Cross may not be able to recognize the instrument as a connectible device. Follow the procedure below to reconnect the instrument to GENNECT Cross.

1. Use the **Bluetooth**[®] setting of your mobile device to delete the instrument.
2. Disable the Z3210's HID function. (p. 73)
3. Use the Instrument Setting of GENNECT Cross to reconnect the instrument.

For detail information, please visit the Z3210's website.

<https://z3210.gennect.net>



Learn more here !

Specifications

General specifications

Operating environment	Indoors, pollution degree 2, altitude up to 2000 m (6562 ft.)	
Operating temperature and humidity range	Temperature	-25°C (-13°F) to 65°C (149°F)
	Humidity	-25°C (-13°F) or higher but less than 40°C (104°F): 80% RH or less 40°C (104°F) or higher but less than 45°C (113°F): 60% RH or less 45°C (113°F) to 65°C (149°F): 50% RH or less (non-condensing)
Storage temperature and humidity range	Temperature	-25°C (-13°F) to 65°C (149°F)
	Humidity	-25°C (-13°F) or higher but less than 40°C (104°F): 80% RH or less 40°C (104°F) or higher but less than 45°C (113°F): 60% RH or less 45°C (113°F) to 65°C (149°F): 50% RH or less (non-condensing) Remove batteries before storing the instrument.

Specifications

Dust resistance and water resistance

IP20 (When measuring voltage under completely dry conditions, when measuring current flowing through a hazardous live conductor under completely dry conditions)

IP50 (When measuring resistance under completely dry conditions, when measuring current flowing through an insulated conductor under completely dry conditions, during storage)

*IP20, IP50

The IP codes indicate the degree of protection provided by the enclosure of the instrument for use in hazardous locations, entry of solid foreign objects, and the ingress of water.

2: Protected against access to hazardous parts with fingers. The equipment inside the enclosure is protected against entry by solid foreign objects larger than 12.5 mm in diameter.

5: Protected against access to hazardous parts with wire measuring 1.0 mm in diameter. Dustproof type (The penetration of dust cannot be prevented completely, but quantities of dust that may hinder the stated operation of equipment or safety cannot penetrate the enclosure.

0: The equipment inside the enclosure is not protected against the harmful effects of water.

Standards

Safety: EN 61010

EMC: EN 61326

Power supply

LR03 alkaline battery ×2

Rated supply voltage: 1.5 V DC × 2

Maximum rated power: 1200 mVA

Continuous operating time	Approx. 25 hours (without the Z3210) Approx. 18 hours (with the Z3210 installed and wirelessly communicating) Other prescribed conditions: When measuring 100 AAC, with the LCD not backlighted, reference value at 23°C
Dimensions	Approx. 65W × 241H × 35D mm (2.56"W × 9.49"H × 1.38"D) (The Jaw is not included in the dimensions of width and depth but in that of height.)
Jaw dimensions	Approx. 79Wj × 20Dj mm (3.11"W × 0.79"D)
Maximum measurable conductor diameter	φ46 mm
Weight	Approx. 450 g (15.9 oz.) (including batteries)
Product warranty duration	3 years
Accessories	See p. 3
Options	See p. 5

Input, output, and measurement specifications

Basic specifications

Measurement items	AC current RMS value/AC current peak value (no polarity)/AC current frequency AC voltage RMS value/AC voltage peak value (no polarity)/AC voltage frequency Single-phase active power/Single-phase apparent power/Single-phase reactive power/Single-phase power factor/Single-phase zero-cross phase angle Balanced 3-phase active power/Balanced 3-phase reactive power/Balanced 3-phase apparent power/Balanced 3-phase power factor/Balanced 3-phase zero-cross phase angle Single-phase active energy (only positive values added)/Phase detection
Maximum input current	As per the frequency derating characteristics (p. 79). (up to 200 Hz, 600 A or less; above 200 Hz, 120000 A•Hz or less)
Maximum rated voltage to terminal	600 V AC
Maximum rated voltage to earth	600 V AC (Measurement category IV), 1000 V AC (Measurement category III) Anticipated transient overvoltage 8000 V
Maximum measuring voltage	600 V AC
Measurement method	True RMS measurement with digital sampling
Measurement terminals	COM terminal, V terminal
Input impedance	1 M Ω or greater

Display refresh rate	2 times/s
Response time	1 s
Crest factor	3 or less for the 6 A and 60 A current ranges 1.6 or less for the 600 A current range and the 600 V voltage range
Zero-display range	<ul style="list-style-type: none">• Voltage and current RMS values: 29 counts or less• If they fall within the zero-display range, current (voltage) peak values and active/apparent/reactive power values are shown as zero, while current (voltage) frequency, power factor, and zero-cross phase values are shown as "----."• A value of 0 is used in single-phase active energy calculations.

Frequency derating characteristics

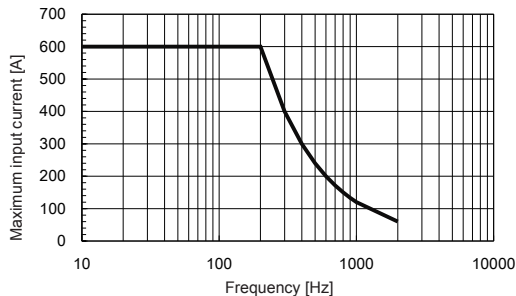

Specifications

Accuracy specifications

Accuracy guarantee conditions	Accuracy guarantee duration: 1 year Accuracy guarantee duration after adjustment made by Hioki: 1 year Accuracy guarantee temperature and humidity range: 23°C ±5°C (73°F ±9°F), 80% RH or less (non-condensing) Number of jaw open/close cycles: 10000 times or less
Input conditions for guaranteed accuracy	Sine wave input
Effects of external magnetic fields	DC/AC 60 Hz, with a 400 A/m external magnetic field: 0.10 A or less
Effects of conductor position	At all positions around the jaw's center-point reference: within ±0.5% (100 A input, f ≤ 100 Hz)
Temperature coefficient	Add "measurement accuracy × 0.1/°C" (excluding 23°C ±5°C [73°F ±9°F]).
Effects of sensor phase	±1° (50 Hz to 60 Hz)

See "Accuracy Table" (p. 83).

Harmonic measurement specifications (with Z3210 connected)

All operations are performed by the GENNECT Cross application software. The following specifications apply only to use of the GENNECT Cross's harmonic analysis functionality. Perform sampling of data by instrument and harmonic analysis calculations by GENNECT Cross.

Measurement conditions	Fundamental frequency 50 Hz/60 Hz
Measurement functionality	AC current/AC voltage (controlled by application software)
Analysis window width	1 cycle (50 Hz/60 Hz)
Window type	Rectangular
Number of data points analyzed	256
Orders analyzed	1st to 30th
Items analyzed	Harmonic level (RMS values for current harmonics [A], RMS values for voltage harmonics [V])
	Harmonic content percentage (content percentages for current harmonics [%], content percentages for voltage harmonics [%])
	Total harmonic distortion (THD-F and THD-R for current [%], THD-F and THD-R for voltage [%])

Specifications

Range (minimum resolution)	AC current	600.0 A (0.1 A)	60.00 A (0.01 A)	6.000 A (0.001 A)
	AC voltage	600.0 V (0.1 V)		
Accuracy input range	Input of 1% of range or greater for each order			
Crest factor	3 or less for the 6 A and 60 A current ranges 1.6 or less for the 600 A current range and the 600 V voltage range			
Data refresh	5 s (reference value)			
Measurement accuracy	Harmonic level (RMS value)	Order	Accuracy	
		1 to 10	±5.0% rdg ±10 dgt	
		11 to 20	±10% rdg ±10 dgt	
	21 to 30	±20% rdg ±10 dgt		
	Harmonic content percentage	±1 dgt for calculations performed using measured values		
Total harmonic distortion	±1 dgt for calculations performed using measured values			

Accuracy Table

(1) AC Current Measurement

The current RMS (I_{RMS}) and current peak value ($I_{|PEAK|}$) ranges will change at the same time.

Automatic range threshold: Range up: Current RMS value greater than 6000 count
Range down: Current RMS value less than 540 count

AC current RMS (I_{RMS})	Range (Accuracy guarantee range)	Resolution	Accuracy		
		Display range	45 Hz ≤ f ≤ 66 Hz	66 Hz < f ≤ 500 Hz	500 Hz < f ≤ 1 kHz
	6.000 A (0.060 A to 6.000 A)	0.001 A	±1.3% rdg ±3 dgt	±2.0% rdg ±5 dgt	±5.0% rdg ±5 dgt
		0.000 A to 6.000 A			
	60.00 A (0.60 A to 60.00 A)	0.01 A	±1.0% rdg ±3 dgt	±1.5% rdg ±5 dgt	±3.0% rdg ±5 dgt
		0.00 A to 60.00 A			
	600.0 A (6.0 A to 600.0 A)	0.1 A			
		0.0 A to 600.0 A			–

Accuracy Table

AC current peak value ($I_{ PEAK }$) Zero to Peak No polarity (absolute value of the maximum wave height during the display update interval)	Range (Accuracy guarantee range is specified in terms of current RMS values.)	Resolution	Accuracy		
		Display range	45 Hz \leq f \leq 66 Hz	66 Hz < f \leq 500 Hz	500 Hz < f \leq 1 kHz
	6.000 A (0.060 A to 6.000 A)	0.01 A	$\pm 3.0\%$ rdg ± 5 dgt		$\pm 5.0\%$ rdg ± 5 dgt
		0.00 A to 18.00 A			
	60.00 A (0.60 A to 60.00 A)	0.1 A	$\pm 2.5\%$ rdg ± 5 dgt		
		0.0 A to 180.0 A			
	600.0 A (6.0 A to 600.0 A)	1 A			
		0 A to 1000 A			
AC current frequency ($FREQ_i$)	Range (Accuracy guarantee range)	Resolution	Accuracy		
		Display range	Current frequency values are shown as “----” when the current RMS value is less than 150 count. Current frequency values of less than 45.0 Hz are shown as “-----”		
	999.9 Hz (45.0 Hz to 999.9 Hz)	0.1 Hz	$\pm 0.3\%$ rdg ± 3 dgt		
		45.0 Hz to 999.9 Hz			

(2) AC Voltage Measurement

AC voltage RMS value (U_{RMS})	Range (Accuracy guarantee range)	Resolution	Accuracy		
		Display range	45 Hz \leq f \leq 66 Hz	66 Hz < f \leq 500 Hz	500 Hz < f \leq 1 kHz
	600 V (80.0 V to 600.0 V)	0.1 V 0.0 V to 600.0 V	$\pm 0.7\%$ rdg ± 3 dgt	$\pm 1.0\%$ rdg ± 5 dgt	$\pm 3.0\%$ rdg ± 5 dgt
AC voltage peak value (U_{PEAK}) Zero to Peak No polarity (absolute value of the maximum wave height during the display update interval)	Range (Accuracy guarantee range is specified in terms of voltage RMS values.)	Resolution	Accuracy		
		Display range	45 Hz \leq f \leq 66 Hz	66 Hz < f \leq 500 Hz	500 Hz < f \leq 1 kHz
	600 V (80.0 V to 600.0 V)	1 V 0 V to 1000 V	$\pm 2.5\%$ rdg ± 5 dgt		$\pm 4.0\%$ rdg ± 5 dgt
AC voltage frequency ($FREQ_v$)	Range (Accuracy guarantee range)	Resolution	Accuracy		
		Maximum display	Voltage frequency values are shown as "----" when the voltage RMS value is less than 150 count. Voltage frequency values of less than 45.0 Hz are shown as "----."		
	999.9 Hz (45.0 Hz to 999.9 Hz)	0.1 Hz 999.9 Hz	$\pm 0.3\%$ rdg ± 3 dgt		

Accuracy Table

(3) Single-phase power measurement, balanced 3-phase/4-wire power measurement

Automatic range threshold: Range up: Current RMS value greater than 6000 count
 Range down: Current RMS value less than 540 count

Effective measuring range	Current RMS value (I_{RMS})	0.060 A to 600.0 A Value must fall within the current measurement range's guaranteed accuracy range.				
	Voltage RMS value (U_{RMS})	80.0 V to 600.0 V				
	Frequency	50 Hz/60 Hz				
Single-phase active power/ Balanced 3-phase/4-wire active power ($PIP_{(3P4W)}$)	Range configuration (minimum resolution)			Current range		
				6.000 A	60.00 A	600.0 A
	Voltage range	600.0 V	Single-phase	3.600 kW (0.001 kW)	36.00 kW (0.01 kW)	360.0 kW (0.1 kW)
			3-Phase 4-Wire	10.80 kW (0.01 kW)	108.0 kW (0.1 kW)	1080 kW (1 kW)
	Accuracy (Power factor =1)		Single-phase	±2.0% rdg ±7 dgt		±1.7% rdg ±5 dgt
			3-Phase 4-Wire	±2.0% rdg ±3 dgt		±1.7% rdg ±2 dgt

Single-phase apparent power/ Balanced 3-phase/4-wire apparent power ($S S_{(3P4W)}$) Single-phase reactive power/ Balanced 3-phase/4-wire reactive power ($Q Q_{(3P4W)}$)	Accuracy	± 1 dgt relative to calculation from measured values	
	Range configuration	For the above active power range configuration, the unit [W] is replaced by [VA] for apparent power values. For reactive power values, the unit [W] is replaced by [var].	
Single-phase power factor/ Balanced 3-phase/4-wire power factor ($PF PF_{(3P4W)}$)	Accuracy	± 1 dgt relative to calculation from measured values	
	Range configuration	Regeneration	-1.000 to -0.001
		Consumption	0.000 to 1.000
Zero-cross phase angle (ϕ)*	Accuracy	$\pm 3^\circ$	
	Range configuration	Lead	-180.0° to -0.1°
		Lag	0.0° to 179.9°

*: Value is calculated based on the measurement of the zero-cross phase difference for the voltage and current waveforms (positive [no sign] when the current lags the voltage and negative when the current leads the voltage).

Accuracy Table

(4) Balanced 3-phase/3-wire power measurement

Automatic range threshold: Range up: Current RMS value greater than 6000 count

Range down: Current RMS value less than 540 count

Effective measuring range	Current RMS value (I_{RMS})	0.060 A to 600.0 A Value must fall within the current measurement range's guaranteed accuracy range.				
	Voltage RMS value (U_{RMS})	80.0 V to 600.0 V				
	Frequency	50 Hz/60 Hz				
Balanced 3-phase/3-wire active power ($P_{(3P3W)}$)	Accuracy	$\pm 3.0\%$ rdg ± 10 dgt (Power factor =1)				
	Range configuration (minimum resolution)			Current range		
				6.000 A	60.00 A	600.0 A
		Voltage range	600.0 V	7.200 kW (0.001 kW)	72.00 kW (0.01 kW)	720.0 kW (0.1 kW)
Balanced 3-phase/3-wire apparent power ($S_{(3P3W)}$)	The unit [W] is replaced by [VA] for apparent power values.					
Balanced 3-phase/3-wire reactive power ($Q_{(3P3W)}$)	Accuracy	± 1 dgt relative to calculation from measured values				
	Range configuration	For the above active power range configuration, the unit [W] is replaced by [var].				

Balanced 3-phase/3-wire power factor ($PF_{(3P3W)}$)	Accuracy	$\pm 3^\circ \pm 2$ dgt (Calculated from the balanced 3-phase/3-wire zero-cross phase angle)	
	Range configuration	Regeneration	-0.001
		Consumption	0.000 to 1.000
Balanced 3-phase/3-wire zero-cross phase angle ($\phi_{(3P3W)}$)*	Accuracy	$\pm 3^\circ$	
	Range configuration	Lead	-90.0° to -0.1°
		Lag	0.0° to 90.0°

*: Value is calculated based on the measurement of the zero-cross phase difference for the voltage and current waveforms (positive [no sign] when the current lags the voltage and negative when the current leads the voltage).

(5) Single-phase active energy measurement (AC)

Effective measuring range	Current RMS value (I_{RMS})	0.060 A to 600.0 A Value must fall within the current measurement range's guaranteed accuracy range.
	Voltage RMS value (U_{RMS})	80.0 V to 600.0 V
	Frequency	50 Hz/60 Hz

Accuracy Table

Single-phase active energy (Wh)	Measurement method		Only the consumption (positive) component of active power is integrated* every 0.5 sec. * When integration is stopped, the last 0.5 s of energy measured is divided into 5 equal intervals and integrated every 0.1 s.
	Range configuration	Display range	<ul style="list-style-type: none"> • After the single-phase active power range is selected, integration starts with a value of 0.00 Wh. Only auto-range operation is supported for active energy measurement. When values exceed 9999 count, the range is switched to the next higher range. • The range is fixed to the active power range in use when integrated began.
	99.99 Wh	0.00 Wh to 99.99 Wh	
	999.9 Wh	100.0 Wh to 999.9 Wh	
	9.999 kWh	1.000 kWh to 9.999 kWh	
	99.99 kWh	10.00 kWh to 99.99 kWh	
	999.9 kWh	100.0 kWh to 999.9 kWh	
9999 kWh	1000 kWh to 9999 kWh		
Integration time display	59:59 [min:sec]		<p>The time is incremented by 1 s from 00:00 [min:sec].</p> <p>When 59:59 [min:sec] is exceeded, the range is switched to the 48:00 [hour:min] range.</p> <p>During integration using the 48:00 [hour:min] range, the “:” display flashes every 0.5 s.</p>
	48:00 [hour:min]		

(6) Phase detection

Detected voltage range	80 V AC to 600 V AC
Detection target frequency	50 Hz/60 Hz (sine wave)
Phase order detection*	Normal phase (Display: 123) Reverse phase (Display: 321) Open phase or unable to measure (Display: “---”)

*: Measurement is not possible if the second measured value fails to stabilize within 10 s once the display changes to the second measurement screen.

Range configuration when setting a CT ratio

CT ratio	1/1 (default value)	1/10	1/100	1/1000	Remarks
Current RMS value	600.0 A	6000 A	–	–	CT ratio 1/1 Same accuracy specifications as 600.0 A.
	60.00 A	600.0 A	6000 A	–	CT ratio 1/1 Same accuracy specifications as 60.00 A.
	6.000 A	60.00 A	600.0 A	6000 A	CT ratio 1/1 Same accuracy specifications as 6.000 A.
Current peak value	1000 A	10.00 kA	–	–	CT ratio 1/1 Same accuracy specifications as 600.0 A.
	180.0 A	1800 A	18.00 kA	–	CT ratio 1/1 Same accuracy specifications as 60.00 A.
	18.00 A	180.0 A	1800 A	18.00 kA	CT ratio 1/1 Same accuracy specifications as 6.000 A.
Single-phase active power	360.0 kW	3600 kW	–	–	CT ratio 1/1 Same accuracy specifications as 360.0 kW.
	36.00 kW	360.0 kW	3600 kW	–	CT ratio 1/1 Same accuracy specifications as 36.00 kW.
	3.600 kW	36.00 kW	360.0 kW	3600 kW	CT ratio 1/1 Same accuracy specifications as 3.600 kW.

CT ratio	1/1 (default value)	1/10	1/100	1/1000	Remarks
Balanced 3-phase/3-wire active power	720.0 kW	7200 kW	–	–	CT ratio 1/1 Same accuracy specifications as 720.0 kW.
	72.00 kW	720.0 kW	7200 kW	–	CT ratio 1/1 Same accuracy specifications as 72.00 kW.
	7.200 kW	72.00 kW	720.0 kW	7200 kW	CT ratio 1/1 Same accuracy specifications as 7.200 kW.
Balanced 3-phase/4-wire active power	1080 kW	9999 kW* ¹	–	–	CT ratio 1/1 Same accuracy specifications as 1080 kW.
	108.0 kW	1080 kW	9999 kW* ¹	–	CT ratio 1/1 Same accuracy specifications as 108.0 kW.
	10.80 kW	108.0 kW	1080 kW	9999 kW* ¹	CT ratio 1/1 Same accuracy specifications as 10.80 kW.

- Add the accuracy of the appropriate CT.
- The unit is replaced as below for apparent power and reactive power, relative to the active power range.
Apparent power: kVA
Reactive power: kVAR

*1: Multiply the digit error indicated in the accuracy specifications noted in the “Remarks” column by 10.

Equations

(1) Single-phase power measurement

Apparent power	S	$U_{\text{RMS}} \cdot I_{\text{RMS}}$	<ul style="list-style-type: none"> The active power P has no sign during consumption and a negative sign during generation. Due to the effects of measurement error, $S= P$ and $Q=0$ are used when $S < P$.
Reactive power	Q	$\sqrt{S^2 - P^2}$	
Power factor	PF	$\frac{P}{S}$	

(2) Balanced 3-phase/3-wire power measurement

Balanced 3-phase/3-wire zero-cross phase angle	$\phi_{(3P3W)}$	$\phi - 30^\circ$	<ul style="list-style-type: none"> The symbol ϕ represents the zero-cross phase angle of the voltage U_{12} and the current I_1. The symbol S represents the apparent power of the line voltage U_{12} and the wire current I_1.
Balanced 3-phase/3-wire power factor	$PF_{(3P3W)}$	$\cos \left\{ \phi_{(3P3W)} \right\}$	
Balanced 3-phase/3-wire active power	$P_{(3P3W)}$ [W]	$\sqrt{3} \cdot PF_{(3P3W)} \cdot S$	
Balanced 3-phase/3-wire apparent power	$S_{(3P3W)}$ [VA]	$\sqrt{3} \cdot S$	
Balanced 3-phase/3-wire reactive power	$Q_{(3P3W)}$ [var]	$\sqrt{S_{(3P3W)}^2 - P_{(3P3W)}^2}$	

(3) Balanced 3-phase/4-wire power measurement

Balanced 3-phase/4-wire active power	$P_{(3P4W)}$ [W]	$3 \cdot P$	<ul style="list-style-type: none"> The symbol P represents the active power of the phase voltage U_1 and the wire current I_1. The symbol S represents the apparent power of the phase voltage U_1 and the wire current I_1. The symbol Q represents the reactive power of the phase voltage U_1 and the wire current I_1. The active power P has no sign during consumption and a negative sign during generation. Due to the effects of measurement error, $S= P$ and $Q=0$ are used when $S < P$.
Balanced 3-phase/4-wire apparent power	$S_{(3P4W)}$ [VA]	$3 \cdot S$	
Balanced 3-phase/4-wire reactive power	$Q_{(3P4W)}$ [var]	$3 \cdot Q$	
Balanced 3-phase/4-wire power factor	$PF_{(3P4W)}$	$\frac{P_{(3P4W)}}{S_{(3P4W)}}$	

(4) Unbalanced 3-phase/3-wire power measurement

Unbalanced 3-phase/3-wire active power	$P_{(UB3P3W)}$ [W]	$P1+P2$	<ul style="list-style-type: none"> The symbol $P1$ represents the active power of the line voltage U_{21} and the wire current I_1. The symbol $P2$ represents the active power of the line voltage U_{23} and the wire current I_3. The active power P has no sign during consumption and a negative sign during generation.
---	-----------------------	---------	---

(5) Unbalanced 3-phase/4-wire power measurement

Unbalanced 3-phase/4-wire active power	$P_{(UB3P4W)}$ [W]	$P1+P2+P3$	<ul style="list-style-type: none"> • The symbol $P1$ represents the active power of the phase voltage U_1 and the wire current I_1. • The symbol $P2$ represents the active power of the phase voltage U_2 and the wire current I_2. • The symbol $P3$ represents the active power of the phase voltage U_3 and the wire current I_3. • The active power P has no sign during consumption and a negative sign during generation.
Unbalanced 3-phase/4-wire apparent power	$S_{(UB3P4W)}$ [VA]	$S1+S2+S3$	<ul style="list-style-type: none"> • The symbol $S1$ represents the apparent power of the phase voltage U_1 and the wire current I_1. • The symbol $S2$ represents the apparent power of the phase voltage U_2 and the wire current I_2. • The symbol $S3$ represents the apparent power of the phase voltage U_3 and the wire current I_3. • Due to the effects of measurement error, $S= P$ is used when $S< P$.

Unbalanced 3-phase/4-wire reactive power	$Q_{(UB3P4W)}$ [var]	$Q1+Q2+Q3$	<ul style="list-style-type: none"> • The symbol $Q1$ represents the reactive power of the phase voltage U_1 and the wire current I_1. • The symbol $Q2$ represents the reactive power of the phase voltage U_2 and the wire current I_2. • The symbol $Q3$ represents the reactive power of the phase voltage U_3 and the wire current I_3. • Due to the effects of measurement error, $Q=0$ is used when $S< P$.
Unbalanced 3-phase/4-wire power factor	$PF_{(UB3P4W)}$	$\frac{P_{(UB3P4W)}}{S_{(UB3P4W)}}$	—

(6) (Reference) Harmonic calculations

Calculated by GENNECT Cross

Harmonic current	RMS value [A]	–	$\sqrt{I_{kr}^2 + I_{ki}^2}$
	Harmonic content percentage for k th order [%]	–	$\frac{\sqrt{I_{kr}^2 + I_{ki}^2}}{\sqrt{I_{1r}^2 + I_{1i}^2}} \times 100 [\%]$
	Total harmonic distortion [%]	<i>THD-F</i>	$\frac{\sqrt{\sum_{k=2}^{30} (I_{kr}^2 + I_{ki}^2)}}{\sqrt{I_{1r}^2 + I_{1i}^2}} \times 100 [\%]$
		<i>THD-R</i>	$\frac{\sqrt{\sum_{k=2}^{30} (I_{kr}^2 + I_{ki}^2)}}{\sqrt{\sum_{n=1}^{256} (I'_n)^2}} \times 100 [\%]$

Harmonic voltage	RMS value [V]	–	$\sqrt{U_{kr}^2 + U_{ki}^2}$
	Harmonic content percentage for k th order [%]	–	$\frac{\sqrt{U_{kr}^2 + U_{ki}^2}}{\sqrt{U_{1r}^2 + U_{1i}^2}} \times 100 [\%]$
	Total harmonic distortion [%]	$THD-F$	$\frac{\sqrt{\sum_{k=2}^{30} (U_{kr}^2 + U_{ki}^2)}}{\sqrt{U_{1r}^2 + U_{1i}^2}} \times 100 [\%]$
		$THD-R$	$\frac{\sqrt{\sum_{k=2}^{30} (U_{kr}^2 + U_{ki}^2)}}{\sqrt{\sum_{n=1}^{256} (U'_n)^2}} \times 100 [\%]$

Index

k : Analyzed order

r : Post-FFT resistance component

i : Post-FFT reactance component

I' : Current sampling value

U' : Voltage sampling value

Maintenance and Service

WARNING



Do not attempt to modify, disassemble, or try to repair the instrument. Doing so may cause a fire, electric shock, or injury.

Cleaning

- If the instrument becomes dirty, wipe the instrument clean with a soft cloth slightly moistened with water or mild detergent.
- Measurements are degraded by dirt on the mating surfaces of the jaw, so keep the surfaces clean by gently wiping with a soft, dry cloth.
- Wipe the LCD gently with a soft, dry cloth.

IMPORTANT

Never use solvents such as benzene, alcohol, acetone, ether, ketone, thinners or gasoline. Doing so could deform and discolor the instrument.

Disposal

Handle and dispose of the instrument and batteries in accordance with local regulations.

Shipping Precautions

Be sure to observe the following precautions:

- Remove batteries, accessories and options from the instrument to avoid damage. Moreover, be sure to pack in a double carton. Accidental damage suffered in transit is not covered by the warranty.
- Attach a description of the malfunction when sending the instrument for repair.

Calibration

The calibration period varies with the conditions and environment of use. It is recommended to determine a calibration period based on those factors and to have the instrument regularly calibrated by Hioki. Please contact your Hioki distributor to have your instrument periodically calibrated.

Troubleshooting

If damage is suspected, check the following before contacting your authorized Hioki distributor or reseller.

Problem	Cause	Remedy
The instrument is indicating an abnormal measured value.	The measured value is lower than the lower limit value of the measuring range.	Wrap the wire around the jaw one or more times. Wrapping the wire n times can increase the displayed value by $(n + 1)$ times.
	The tips of the jaw open.	Close the jaw tips.
	The jaw is damaged.	The instrument with its jaw damaged cannot measure current accurately. Have the instrument repaired.
	Displayed values can frequently fluctuate due to induction potential even with no input. This, however, is not a malfunction.	

Problem	Cause	Remedy
Measured value differ from those of another clamp-on current meter.	Measured waveforms contain a component that falls outside the frequency characteristics range.	The instrument cannot accurately measure waveforms that contain a component that falls outside the frequency characteristics range.
	The instrument, which uses the true RMS method, can accurately measure distorted waveforms. When measuring a distorted waveform, the measured value will differ from a clamp-on current meter that uses the averaging method.	
The current value is larger than expected. A current value is displayed even with no input.	There is a transformer or high-current circuit that emits a strong magnetic field near the instrument. Otherwise, there is a wireless device that emits a strong electric field.	Perform measurement keeping the instrument away from such equipment.
The instrument's jaw emits sound (vibration).	Greater than or equal to 500 A of AC current is being measured.	The jaw may emit sound (vibration); however, there is no effect on the measurement.
The measured value does not appear.	The connection cords have a break.	Check the continuity of the connection cords. If a break is found, replace the connection cords.

Troubleshooting



Problem	Cause	Remedy
No measured value is displayed even when the connection cords are shorted.	The connection cords are not inserted all the way.	Insert the connection cords all the way.



If problems cannot be resolved even after you have implemented such remedies, have the instrument repaired.

Error and operational displays

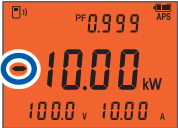
Display	Description		Solution
v.UP	The instrument's firmware is being upgraded.		Do not remove the batteries until the upgrade completes.
Err 001	ROM error	Program	The instrument needs to be repaired. Please contact your authorized Hioki distributor or reseller.
Err 002	ROM error	Adjustment data	
Err 005	ADC error	Hardware malfunction	
Err 008	Z3210 communication error	The Z3210 is malfunctioning or is not properly connected	<p>Perform the following steps (p. 26):</p> <ul style="list-style-type: none"> • Disconnect and then reconnect the Z3210. • If you have another Z3210, replace the unit in question with that one. <p>If the error continues to be displayed, the instrument needs to be repaired. Please contact your authorized Hioki distributor or reseller.</p>

Warning display

Display	Buzzer	Cause	Solution	
	Flashes red	–	Measurement resulted in a negative active power value.	The instrument may not be connected properly. Reconnect the instrument to the circuit being measured.
	Lights red	Intermittent sound	Phase detection indicated reverse phase.	–

Display	Buzzer	Cause	Solution	
 <p>e.g.: for current measurement</p>	Flashes red	Intermittent sound	A current or voltage exceeding the maximum input was input to the instrument.	Stop measurement immediately as the current or voltage cannot be measured by the instrument. For current measurement, the optional 9290-10 can be used to measure currents of up to 1000 AAC. When manual range is 6 A and 60 A range, this warning display will not appear.
 <p>e.g.: for current measurement</p>	Lights red	—	A current or voltage exceeding the range was input while using a manual range.	Change the measurement range or select the AUTO range.

Warranty Certificate

HIOKI

Model	Serial number	Warranty period Three (3) years from date of purchase (___ / ___ / ___)
-------	---------------	--

Customer name: _____

Customer address: _____

Important

- Please retain this warranty certificate. Duplicates cannot be reissued.
- Complete the certificate with the model number, serial number, and date of purchase, along with your name and address. The personal information you provide on this form will only be used to provide repair service and information about HioKI products and services.

This document certifies that the product has been inspected and verified to conform to HioKI's standards.

Please contact the place of purchase in the event of a malfunction and provide this document. In which case HioKI will repair or replace the product subject to the warranty terms described below.

Warranty terms

1. The product is guaranteed to operate properly during the warranty period (three [3] years from the date of purchase). If the date of purchase is unknown, the warranty period is defined as three (3) years from the date (month and year) of manufacture (as indicated by the first four digits of the serial number in YYMM format).
2. If the product came with an AC adapter, the adapter is warranted for one (1) year from the date of purchase.
3. The accuracy of measured values and other data generated by the product is guaranteed as described in the product specifications.
4. In the event that the product or AC adapter malfunctions during its respective warranty period due to a defect of workmanship or materials, HioKI will repair or replace the product or AC adapter free of charge.
5. The following malfunctions and issues are not covered by the warranty and as such are not subject to free repair or replacement:
 - 1. Malfunctions or damage of consumables, parts with a defined service life, etc.
 - 2. Malfunctions or damage of connectors, cables, etc.
 - 3. Malfunctions or damage caused by shipment, dropping, relocation, etc., after purchase of the product
 - 4. Malfunctions or damage caused by inappropriate handling that violates information found in the instruction manual or on precautionary labeling on the product itself
 - 5. Malfunctions or damage caused by a failure to perform maintenance or inspections as required by law or recommended in the instruction manual
 - 6. Malfunctions or damage caused by fire, storms or flooding, earthquakes, lightning, power anomalies (involving voltage, frequency, etc.), war or unrest, contamination with radiation, or other acts of God
 - 7. Damage that is limited to the product's appearance (cosmetic blemishes, deformation of enclosure shape, fading of color, etc.)
 - 8. Other malfunctions or damage for which HioKI is not responsible
6. The warranty will be considered invalidated in the following circumstances, in which case HioKI will be unable to perform service such as repair or calibration:
 - 1. If the product has been repaired:
 - 2. If the product has been embedded in another piece of equipment for use in a special application (aerospace, nuclear power, medical use, vehicle control, etc.) without HioKI's having received prior notice
7. If you experience a loss caused by use of the product and HioKI determines that it is responsible for the underlying issue, HioKI will provide compensation in an amount not to exceed the purchase price, with the following exceptions:
 - 1. Secondary damage arising from damage to a measured device or component that was caused by use of the product
 - 2. Damage arising from measurement results provided by the product
 - 3. Damage to a device other than the product that was sustained when connecting the device to the product (including via network connections)
8. HioKI reserves the right to decline to perform repair, calibration, or other service for products for which a certain amount of time has passed since their manufacture, products whose parts have been discontinued, and products that cannot be repaired due to unforeseen circumstances.

HIOKI E.E. CORPORATION
<http://www.hioki.com>

18-07 EN-3

HIOKI

www.hioki.com/



**All regional
contact
information**

HEADQUARTERS

81 Koizumi
Ueda, Nagano 386-1192 Japan

HIOKI EUROPE GmbH

Helfmann-Park 2
65760 Eschborn, Germany
hioki@hioki.eu

2111 EN

Edited and published by HIOKI E.E. CORPORATION

Printed in Japan

- CE declarations of conformity can be downloaded from our website.
- Contents subject to change without notice.
- This document contains copyrighted content.
- It is prohibited to copy, reproduce, or modify the content of this document without permission.
- Company names, product names, etc. mentioned in this document are trademarks or registered trademarks of their respective companies.