



PSW-Series

Multi-Range D.C. Power Supply

FEATURES

- Voltage Rating : 30V/80V, Output Power Rating : 360W~1080W
- Constant Power Output for Multi-Range (V & I) Operation
- C.V / C.C Priority ; Particularly Suitable for the Battery and LED Industry
- Adjustable Slew Rate
- Series and Parallel Operation (2 units in Series/3 units in Parallel Maximum)
- High Efficiency and High Power Density
- 1/6 Rack Mount Size Design (EIA/JIS Standard) for 360W
- Standard Interface : LAN, USB, Analog Control Interface
- Optional Interface : GPIB-USB Adaptor
- LabVIEW Driver

GW INSTEK
Simply Reliable

A. MULTI-RANGE OPERATION

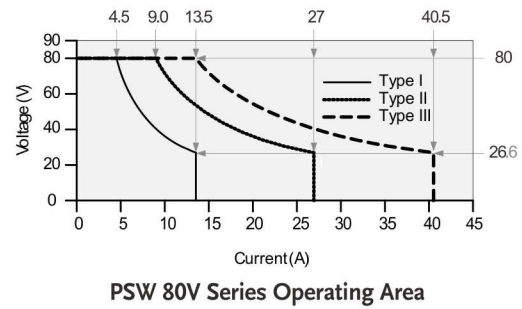
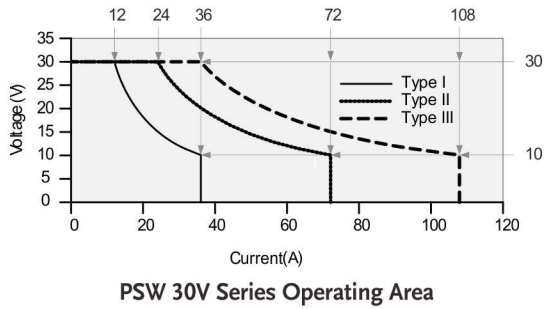

When the power supply is configured that the total output (Current x Voltage output) is less than the rated power output, it functions as a typical Constant Current (C.C) and Constant Voltage (C.V) power supply. However, when the power supply

is configured such that the total output power (Current x Voltage Output) exceeds the rated power output, the effective output is actually limited to the operation area of the unit.

B. C.V / C.C PRIORITY SELECTION

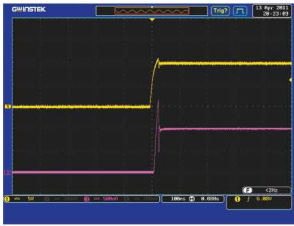

The Inrush Current and Surge Voltage occur at LED Forward Voltage(Vf) Under C.V Priority

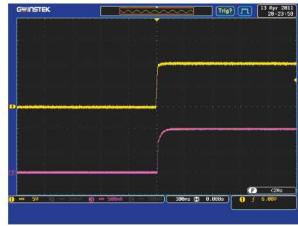

The CC Priority Feature Effectively Limits the Occurrence of Inrush Current and Surge Voltage when the Supplied Voltage Rises to the LED Forward Voltage

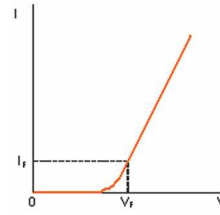

V-I Characteristic of Diode

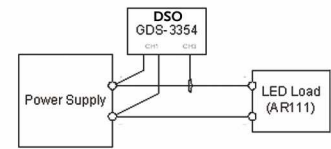

Using GDS-3354 DSO to Test LED Operation Under C.V Priority and C.C Priority Respectively

The PSW-Series provides C.C Mode and C.V Mode to fit various applications in the general purpose market. To get into critical application niches, however, the power supply needs to provide

advanced features to meet the specific requirements. The C.C and C.V Priority Selection enable the power supply to run under C.C priority, rather than normal CV priority, at the output-on stage.

C. ADJUSTABLE SLEW RATE

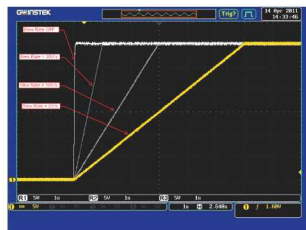

The adjustable rise time of the PSW-Series

The PSW-Series has adjustable slew rates for the level transition of both Current and Voltage. This gives the PSW-Series power supply the ability to set specific rise time and fall time of the Voltage and Current drawn from the power supply to verify DUT performance during the Voltage / Current level transition. The feature also provides the benefit to slow down the voltage transition at the power output-on to protect DUT from inrush current damage. This is especially useful for the test of heavy-current-drawn devices like capacitors.

D. BLEEDER CONTROL

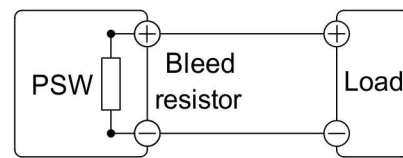

PSW-Series Built-in Bleed Resistor

The PSW-Series employs a bleed resistor in parallel with the output terminal. Bleed resistor is designed to dissipate the power from the power supply filter capacitors when power is turned off and the load is disconnected. Without a bleed resistor, power terminal may remain charged on the filter capacitors for some time and be potentially hazardous. In addition, bleed resistor also allows for smoother voltage regulation of the power supply as the bleed resistor acts as a minimum voltage load. The bleed resistance can be turned on or off using the configuration setting.

E. SERIES AND PARALLEL CONNECTIONS

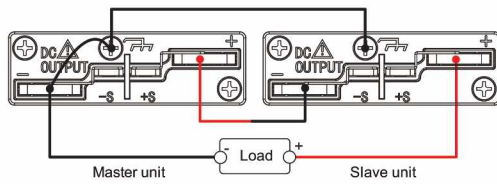

Series Connection

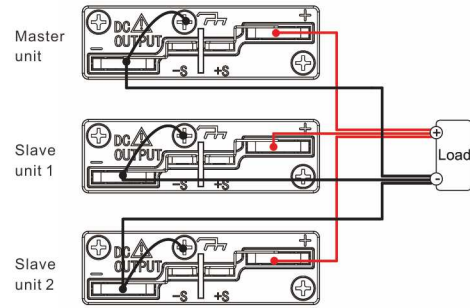

Parallel Connection

To increase power output capacity, the PSW-Series could be connected in Series mode to perform double voltage rating or in parallel mode to perform triple current rating for each model. With Multi-Range feature and Series/Parallel connection

capability, the PSW-Series is a high power density and cost-effective equipment for the tests of DC power modules, batteries and components in a broad power range.

F. OUTPUT ON /OFF DELAY

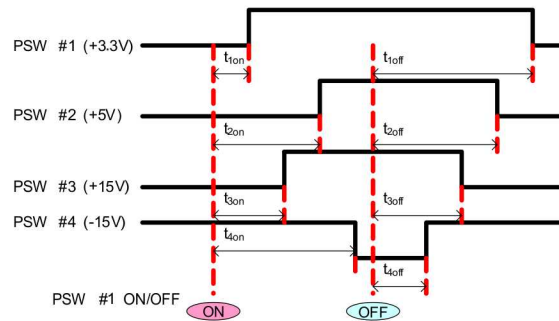

The Example of Output On/Off Delay Control Among Multiple Outputs of the PSW Units

The output On/Off delay feature enables the setting of a specific time delay for output on after the power supply output is turned on, and a specific time delay for output off after the power supply output is turned off. When multiple PSW units are used, the On/

Off delay time of each unit can be set respectively referring to fix time points. This multiple-output control can be done through the Analog Control terminal at the rear panel or through the PC programming with standard commands.

G. VARIOUS INTERFACES SUPPORT & EXTENDED TERMINAL BOX

Analog Control Connector USB Interface for Remote Control



Rear Panel for PSW-Series



GUG-001 GPIB to USB Adapter



GET-001 Extended Terminal

The PSW-Series provides USB Host port in the front panel for easy access of stored data, such as test script program. In the rear panel, a USB Device port is available for remote control or I & V data logging of power output through a PC controller. The LAN interface, which meets DHCP standard, is provided as a standard feature of the PSW-Series for system communications and ATE applications.

An Extender Terminal box (P/N: GET-001) is provided as optional accessory to extend the power output form the rear panel to the front side. This extender terminal gives R&D or QC engineers convenience to do the jobs without frequently reaching the output terminal at the rear side of the PSW-Series.

H. EXTERNAL ANALOG REMOTE CONTROL

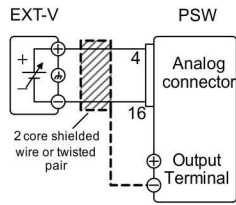

External Voltage Control of the Voltage Output

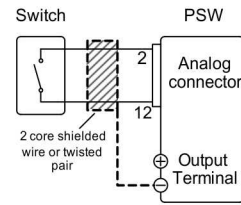

External Switch Control of the Main Power Shut-down

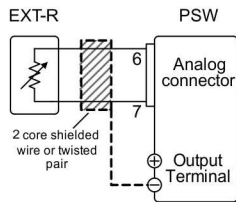

External Resistance control of the Voltage Output

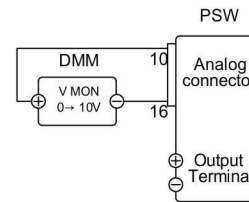

External DMM Monitoring of the Output Voltage

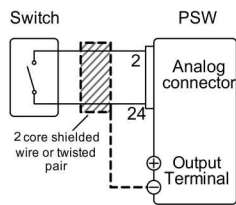

External Switch Control of the Output On/Off

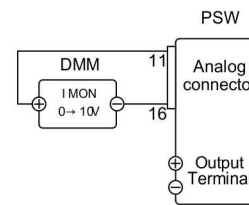

External DMM Monitoring of the Output Current

On the rear panel of the PSW-Series power supply, a 26-pin Analog Control connector is available to perform lots of remote control and monitoring functions. The output voltage and current can be set using external voltage or resistance.

The power supply output on/off and main power shut-down can also be controlled using external switches. This Analog Control Connector is complied with the Mil 26 pin connector (OMRON XG4 IDC plug) standard.

I. USING THE RACK MOUNT KIT



Rack Mount Kit GRA-410-J (JIS)



Rack Mount Kit GRA-410-E (EIA)

The Rack Mount Kit of the PSW-Series supports both EIA and JIS standards. A standard rack can accommodate 6 units of type I (360W Output Power) models, or 3 units of type II (720W Output Power) models, or 2 units of type III (1080W

Output Power) models. The Rack Mount Kits for EIA standard (P/N: GRA-410-E) and for JIS standard (P/N: GRA-410-J) are provided as optional accessories for the PSW-Series.

PANEL INTRODUCTION



1. Voltage Knob
2. Current Knob
3. Output Key
4. Function Keys
5. USB A Port
6. Display
7. Cover Panel
8. Power Switch
9. Analog Control Connector
10. USB B Port
11. Output Terminal (+)
12. Sense Terminal(+/-)
13. Output Terminal (-)
14. Fan
15. AC Input
16. LAN Port

The PSW-Series is a single output multi-range programmable switching DC Power Supply covering a power range up to 1080W. This series of products include six models with the combination of 30V and 80V rated voltages and 360W, 720W and 1080W maximum output powers. The multi-range feature allows the flexible and efficient configuration of voltage and current within the rated power range. As the PSW-Series can be connected in series for maximum 2 units or in parallel for maximum 3 units, the capability of connecting multiple PSW-Series units for higher voltage or higher current output provides a broad coverage of applications. With the flexibility of multi-range power utilization and series/parallel connection, the PSW-Series significantly reduces the user's investment for various power supply products to accommodate the projects with different power requirements.

The C.V/C.C priority selection of the PSW-Series is a very useful feature for DUT protection. The conventional power supply normally operates under C.V mode when the power output is turned on. This could bring a high inrush current to the capacitive load or current-intensive load at the power output-on stage. Taking the I-V curve verification of LED as an example, it becomes a very challenging task to perform this measurement using a conventional power supply. With LED connected to a power supply under C.V mode as the initial setting, when the power output is turned on and the voltage rises to the LED forward voltage, the current will suddenly peak up and exceed the preset value of current limit. Upon detecting this high current, the power supply starts the transition from C.V mode to C.C mode. Though the current becomes stable after the C.C mode is activated, the current spike occurred at the C.V and C.C crossover point may possibly damage the DUT. At the power output-on stage, the PSW-Series is able to run under C.C priority to limit the current spike occurred at the threshold voltage and therefore protects DUT from the inrush current damage.

The adjustable slew rate of the PSW-Series allows user to set for either output voltage or output current a specific rise time at the low to high level transition, and a specific fall time at the high to low level transition. This facilitates the characteristic verification of a DUT during voltage or current level changes with controllable slew rates. The manufacturing tests of lighting device or large capacitance capacitor during power output-on are mostly associated with the occurrence of high surge current, which can greatly reduce the life time of the DUT. To prevent inrush current from damaging current-intensive devices, a smooth and slow voltage transition during power On-Off can significantly reduce the spike current and protect the device from high current damage.

The OVP and OCP protections are provided with the PSW-Series. Both OVP and OCP levels can be selected within the range of 10% to 110%, with default level set at 110%, of the rated voltage/current of the power supply. When any of the protection levels is tripped, the power output will be switched off to protect the DUT. The PSW-Series provides USB Host / Device and LAN interfaces as standard and GPIB-USB adaptor as optional. The LabView driver and the Data Logging PC software are supported on all the interfaces available. An analog control / monitoring connector is also available at the rear panel for external control of power on / off and external monitoring of power output Voltage and Current.

SPECIFICATIONS

	PSW 30-36	PSW 30-72	PSW 30-108	PSW 80-13.5	PSW 80-27	PSW 80-40.5
OUTPUT RATING						
Voltage	0~30V	0~30V	0~30V	0~80V	0~80V	0~80V
Current	0~36A	0~72A	0~108A	0~13.5A	0~27A	0~40.5A
Power	360W	720W	1080W	360W	720W	1080W
REGULATION(CV)						
Load Line	0.05% of rating +5mV 0.05% of rating +3mV					
REGULATION(CC)						
Load Line	0.1% of rating +5mA 0.1% of rating +5mA					
 RIPPLE & NOISE (Noise Bandwidth 20MHz; Ripple Bandwidth=1MHz)						
CV p-p	60mV	80mV	100mV	60mV	80mV	100mV
CV rms	7mV	11mV	14mV	7mV	11mV	14mV
CC rms	72mA	144mA	216mA	27mA	54mA	81mA
PROGRAMMING ACCURACY						
Voltage	0.05% +10mV	0.05% +10mV	0.1% +10mV	0.05% +10mV	0.1% +10mV	0.1% +10mV
Current	0.1% + 30mA	0.1% + 60mA	0.1% + 100mA	0.1% + 30mA	0.1% + 30mA	0.1% + 40mA
READBACK ACCURACY						
Voltage	0.1% +10mV	0.1% +60mV	0.1% +10mV	0.1% +10mV	0.1% +10mV	0.1% +10mV
Current	0.1% + 30mA	0.1% + 30mA	0.1% + 100mA	0.1% + 10mA	0.1% + 30mA	0.1% + 40mA
RESPONSE TIME						
Raise Time	50ms	50ms	50ms	50ms	50ms	50ms
Fall Time(Full Load)	50ms	50ms	50ms	50ms	50ms	50ms
Fall Time(No Load)	500ms	500ms	500ms	500ms	500ms	500ms
Load Transient Recover Time (Load change from 50 to 100%)	1ms	1ms	1ms	1ms	1ms	1ms
PROGRAMMING RESOLUTION (By PC Remote Control Mode)						
Voltage	1mV	1mV	1mV	1mV	1mV	1mV
Current	1mA	2mA	3mA	1mA	2mA	3mA
MEASUREMENT RESOLUTION (By PC Remote Control Mode)						
Voltage	1mV	1mV	1mV	1mV	1mV	1mV
Current	1mA	2mA	3mA	1mA	2mA	3mA
SERIES AND PARALLEL CAPABILITY						
Parallel Operation	Up to 3 units including the master unit					
Series Operation	Up to 2 units including the master unit					
PROTECTION FUNCTION						
OVP	10% to 110% of rated output voltage range					
OCP	10% to 110% of rated output current range					
OHP	Activated by elevated internal temperatures					
FRONT PANEL DISPLAY ACCURACY						
Voltage	0.1% ± 2 digits	0.1% ± 2 digits	0.1% ± 2 digits	0.1% ± 2 digits	0.1% ± 2 digits	0.1% ± 2 digits
Current	0.1% ± 4 digits	0.1% ± 7 digits	0.1% ± 1 digits	0.1% ± 2 digits	0.1% ± 4 digits	0.1% ± 5 digits
ENVIRONMENT CONDITION						
Operation Temp	0°C to 50 °C					
Storage Temp	-25°C to 70 °C					
Operating Humidity	20% to 85% RH					
Storage Humidity	90% RH or Less					
TEMPERATURE COEFFICIENT (after 30 Minutes Warm Up)						
Voltage	100ppm/°C					
Current	200ppm/°C					
OTHER						
Analog Control	Yes					
Interface	USB/LAN/GPIB (Option)					
Fan	With thermal sensing control					
POWER SOURCE	85VAC~265VAC, 50/60Hz, single phase					
DIMENSIONS & WEIGHT	71(W)x124(H)x350(D) mm; Approx. 3kg	142.5(W)x124(H)x350(D) mm; Approx. 5kg	214(W)x124(H)x350(D) mm; Approx. 7kg	71(W)x124(H)x350(D) mm; Approx. 3kg	142.5(W)x124(H)x350(D) mm; Approx. 5kg	214(W)x124(H)x350(D) mm; Approx. 7kg

Specifications subject to change without notice. SW-0000GD2BH

ORDERING INFORMATION

PSW 30-36	(0~30V / 0~36A / 360W) Multi-Range DC Power Supply
PSW 30-72	(0~30V / 0~72A / 720W) Multi-Range DC Power Supply
PSW 30-108	(0~30V / 0~108A / 1080W) Multi-Range DC Power Supply
PSW 80-13.5	(0~80V / 0~13.5A / 360W) Multi-Range DC Power Supply
PSW 80-27	(0~80V / 0~27A / 720W) Multi-Range DC Power Supply
PSW 80-40.5	(0~80V / 0~40.5A / 1080W) Multi-Range DC Power Supply

ACCESSORIES

User Manual x 1, CD-ROM x 1 (Programmable User Manual), GTL-123 Test Lead x 1, Power Cord x 1 (Region dependent), GTL-240 USB Cable x 1,

OPTIONAL ACCESSORIES

PSW-004 Basic Accessories Kit x 1
Includes : M4 Terminal screws and washers x 2, Air Filter x 1, Analog control protection dummy x 1, Analog control lock lever x 1, M8 terminal bolts, nuts and washers x 2,

PSW-001	Accessory Kit for PSW-Series	GUG-001	GPIB to USB Adaptor
PSW-002	Simple IDC Tool	GRA-410-J	Rack Mount Kit
PSW-003	Contact Removal Tool	GRA-410-E	Rack Mount Kit
GTL-240	USB Cable " L " Type	GET-001	Extended Terminal

Global Headquarters

GOOD WILL INSTRUMENT CO., LTD.

No.7-1, Jhongsing Road, Tucheng Dist., New Taipei City 236, Taiwan
T +886-2-2268-0389 F +886-2-2268-0639
E-mail: marketing@goodwill.com.tw

China Subsidiary

GOOD WILL INSTRUMENT (SUZHOU) CO., LTD.

NO. 69, Lushan Road, Snd, Suzhou Jiangsu 215011 China
T +86-512-6661-7177 F +86-512-6661-7277
E-mail: marketing@instek.com.cn

Malaysia Subsidiary

GOOD WILL INSTRUMENT (M) SDN. BHD.

27, Persiaran Mahsuri 1/1, Sunway Tunas,
11900 Bayan Lepas, Penang, Malaysia
T +604-6309988 F +604-6309989
E-mail: sales@goodwill.com.my

U.S.A. Subsidiary

INSTEK AMERICA CORP.

3661 Walnut Avenue Chino, CA 91710, U.S.A.
T +1-909-5918358 F +1-909-5912280
E-mail: sales@instekamerica.com

Japan Subsidiary

INSTEK JAPAN CORPORATION

4F, Prosper Bldg, 1-3-3 Iwamoto-Cho Chiyoda-Ku,
Tokyo 101-0032 Japan
T +81-3-5823-5656 F +81-3-5823-5655
E-mail: info@instek.co.jp

Korea Subsidiary

GOOD WILL INSTRUMENT KOREA CO., LTD.

Room No.805, Ace Hightech-City B/D 1 Dong,
Mullae-Dong 3Ga 55-20, Yeongduengpo-Gu, Seoul, Korea
T +82-2-3439-2205 F +82-2-3439-2207
E-mail: gwinstek@gwinstek.co.kr

GW INSTEK
Simply Reliable

www.gwinstek.com