

LCR Meter

LCR-8230/8220/8210/8205/8201

LCR-8250A/8230A/8220A/8210A/8205A

USER MANUAL

Rev. 1.05



ISO-9001 CERTIFIED MANUFACTURER

GW INSTEK

This manual contains proprietary information, which is protected by copyright. All rights are reserved. No part of this manual may be photocopied, reproduced or translated to another language without prior written consent of Good Will company.

The information in this manual was correct at the time of printing. However, Good Will continues to improve products and reserves the rights to change specification, equipment, and maintenance procedures at any time without notice.

Good Will Instrument Co., Ltd.
No. 7-1, Jhongsing Rd., Tucheng Dist., New Taipei City 236, Taiwan.

Table of Contents

SAFETY INSTRUCTIONS	5
GETTING STARTED	10
LCR-8200 Series Overview	11
Appearance	16
Set Up	19
MEASURE (METER MODE)	23
Setting comparator.....	44
Setting bin sorting.....	50
Setting FILE.....	56
Setting USB disk.....	58
SWEEP (GRAPH MODE)	60
Setting USB disk.....	86
LIST (MULTI STEP MODE)	88
Setting bin sorting.....	115
Setting FILE.....	121
Setting USB disk.....	123
CORRECTION (OPEN/SHORT)	125
SYSTEM CONFIGURATION	144
REMOTE CONTROL	152
Handler Overview.....	153
Configure Interface.....	162
COMMAND OVERVIEW	170
Command Syntax.....	171







Common Commands	174
Command error code	175
Command List	176
APPENDIX	243
Preset	244
Specifications	246
Typical	246
General	246
Specifications	250
Dimensions	253
Certificate Of Compliance	254
Measurement Basics	255
Equivalent Circuit Model Analysis	274

S SAFETY INSTRUCTIONS

This chapter contains important safety instructions that you must follow during operation and storage. Read the following before any operation to ensure your safety and to keep the instrument in the best possible condition.

Safety Symbols

These safety symbols may appear in this manual or on the instrument.

	WARNING	Warning: Identifies conditions or practices that could result in injury or loss of life.
	CAUTION	Caution: Identifies conditions or practices that could result in damage to the LCR-8200 series or to other properties.
		DANGER High Voltage
		Attention Refer to the Manual
		Protective Conductor Terminal
		Earth (ground) Terminal



Do not dispose electronic equipment as unsorted municipal waste. Please use a separate collection facility or contact the supplier from which this instrument was purchased.

Safety Guidelines

General Guideline



CAUTION

- AC voltage input is strictly prohibited.
- Do not place any heavy object on the instrument.
- Avoid severe impact or rough handling that can lead to damaging the instrument.
- Do not discharge static electricity to the instrument.
- Use only mating connectors, not bare wires, for the terminals.
- Do not perform measurement at the source of a low-voltage installation or at building installations (Note below).
- Do not disassemble the instrument unless you are qualified as service personnel.
- Remove all test leads before disconnecting the mains power cord from the socket.
- If the equipment is used in a manner not specified by the manufacturer, the protection provided by the equipment may be impaired.
- The device should be placed in a place where the plug connected to it can be removed easily.

(Note) EN 61010-1:2010 specifies the measurement categories and their requirements as follows. The LCR-8200 Series doesn't fall under category II, III or IV.

- Measurement category IV is for measurement performed at the source of low-voltage installation.
- Measurement category III is for measurement performed in the building installation.
- Measurement category II is for measurement performed on the circuits directly connected to the low voltage installation.

Power Supply



WARNING

- AC Input voltage: 100-240 VAC 50/60Hz
- The power supply voltage should not fluctuate more than 10%.
- Connect the protective grounding conductor of the AC power cord to an earth ground, to avoid electrical shock.

Cleaning the Instrument

- Disconnect the power cord before cleaning.
- Use a soft cloth dampened in a solution of mild detergent and water. Do not spray any liquid.
- Do not use chemicals containing harsh material such as benzene, toluene, xylene, and acetone.

Operation Environment

- Location: Indoor, no direct sunlight, dust free, almost non-conductive pollution (Note below)
- Temperature: 0°C to 40°C
- Humidity:
 - < 30°C: < 80%RH(non-condensing);
 - 30°C~40°C: <70%RH(non-condensing);
 - >40°C: <50%RH (non-condensing)
- Altitude: <2000m

(Note) EN 61010-1:2010 specifies the pollution degrees and their requirements as follows. The LCR-8200 SERIES falls under degree 2.

- Pollution refers to “addition of foreign matter, solid, liquid, or gaseous (ionized gases), that may produce a reduction of dielectric strength or surface resistivity”.
- Pollution degree 1: No pollution or only dry, non-conductive pollution occurs. The pollution has no influence.
- Pollution degree 2: Normally only non-conductive pollution occurs. Occasionally, however, a temporary conductivity caused by condensation must be expected.
- Pollution degree 3: Conductive pollution occurs, or dry, non-conductive pollution occurs which becomes conductive due to condensation which is expected. In such conditions, equipment is normally protected against exposure to direct sunlight, precipitation, and full wind pressure, but neither temperature nor humidity is controlled.

Storage environment

- Location: Indoor
- Temperature: -10°C to 70°C
- Humidity: <80%RH(non-condensing)

Disposal



Do not dispose this instrument as unsorted municipal waste. Please use a separate collection facility or contact the supplier from which this instrument was purchased. Please make sure discarded electrical waste is properly recycled to reduce environmental impact.

Power cord for the United Kingdom

When using the unit in the United Kingdom, make sure the power cord meets the following safety instructions.

NOTE: This lead/appliance must only be wired by competent persons



WARNING: THIS APPLIANCE MUST BE EARTHED

IMPORTANT: The wires in this lead are coloured in accordance with the following code

Green/ Yellow:	Earth
Blue:	Neutral
Brown:	Live (Phase)



As the colours of the wires in main leads may not correspond with the coloured marking identified in your plug/appliance, proceed as follows:

The wire which is coloured Green & Yellow must be connected to the Earth terminal marked with either the letter E, the earth symbol  or coloured Green/Green & Yellow.

The wire which is coloured Blue must be connected to the terminal which is marked with the letter N or coloured Blue or Black.

The wire which is coloured Brown must be connected to the terminal marked with the letter L or P or coloured Brown or Red.

If in doubt, consult the instructions provided with the equipment or contact the supplier.

This cable/appliance should be protected by a suitably rated and approved HBC mains fuse: refer to the rating information on the equipment and/or user instructions for details. As a guide, a cable of 0.75mm² should be protected by a 3A or 5A fuse. Larger conductors would normally require 13A types, depending on the connection method used.

Any exposed wiring from a cable, plug or connection that is engaged in a live socket is extremely hazardous. If a cable or plug is deemed hazardous, turn off the mains power and remove the cable, any fuses and fuse assemblies. All hazardous wiring must be immediately destroyed and replaced in accordance to the above standard.

GETTING STARTED

This chapter describes the LCR-8200 SERIES in a nutshell, including accessories, package contents, its main features and front / rear panel introduction.



LCR-8200 Series Overview	11
Series lineup.....	11
Characteristics.....	12
Accessories.....	14
Package Contents.....	15
Appearance	16
Front Panel	16
Rear Panel	18
Set Up	19
Tilting the Stand.....	19
Power UP.....	20
Connect to the test terminal.....	21

LCR-8200 Series Overview

Series lineup

The LCR-8200 series consists of 5 models (LCR-8200 series) and 5 models with Analysis (LCR-8200A series).

Model name	Basic accuracy	Test speed	Interface
LCR-8200(A) Series	$\pm 0.08\%$	400 times/s	RS-232/USB/LAN GPIB/Handler

Model name	Measurement frequency
LCR-8250A	DC, 10~50MHz
LCR-8230/8230A	DC, 10~30MHz
LCR-8220/8220A	DC, 10~20MHz
LCR-8210/8210A	DC, 10~10MHz
LCR-8205/8205A	DC, 10~5MHz
LCR-8201	DC, 10~1MHz

Characteristics

Thank you for using LCR-8200(A) SERIES LCR Meter as your testing instrument. This Manual contains the detailed installation steps. To ensure personnel safety and to protect your equipment and data, please check if the following accessories are fully supplied before starting the installation.

The test frequency of the LCR-8200(A) SERIES LCR Meter is DC 10Hz-50MHz and the test signal is 10mV-2Vrms and is suitable for the LCR and DCR testes of AC signals. The measurement in a continuously changing environment can be executed stage-by-stage with the test frequency and grade, and high-speed continuous tests can be performed under different test and mode conditions. The machine also supports RS-232, USB, LAN and GPIB PC connection capabilities to improve the design and test efficiency significantly.

The another LCR-8200A Series offers 7 models of 3-element and 4-element equivalent circuits. Equivalent circuit parameters can be calculated based on the DUT measurement results, and frequency characteristics can be displayed on the screen based on the input equivalent circuit parameters.

The performance, convenience and operation flexibility of the LCR Meter have become indispensable tools for the professional measuring technicians.

Such meter can meet customer demands for price, speed, capacity, accuracy and multi-function by its well-based flexibility in combination and implementation. Therefore, it can be used in the testing of a variety of components such as resistor, capacitor, inductor, oscillator, sensor, time-delay wire, filter and resonator.

Performance	<ul style="list-style-type: none">• Signal source frequency range: DC, 10Hz ~ 1/5/10/20/30/50MHz• Basic accuracy up to $\pm 0.08\%$
Features	<ul style="list-style-type: none">• Signal source grade: 10mV ~ 2V / 100μA ~ 20mA

-
- ALC function
 - Output resistance 25 Ω /100 Ω , switchable
 - Parameters: $|Z|$, $|Y|$, θ , R, X, G, B, L, C, D, Q, DCR, Vac, Iac, Vdc, Idc, etc.
 - Ultra-high measuring speed
 - Open circuit/short circuit/load calibration function
 - Meter mode, multi step list mode, sweep mode
 - Up to four component parameters can be selected in the electric meter mode. The induction and DCR values can be measured and displayed simultaneously
 - Up to 48 sets of multistep list programs can be stored in the permanent memory and up to 15 test steps can be arranged in each program
 - There are 7 equivalent circuit analysis function modes (only for LCR-8200A)
 - 7" 800*480 TFT LCD color screen
 - Ultra-low power consumption (<65VA) without fans and zero noise

Interface

- Rapid automation and data access function is realizable for USB, LAN, GPIB and RS232 interfaces
 - PC connection data save software is stander
 - Auto component classification: Comparator function and Handler BIN classification function
 - Input: Trigger signal.
-

Accessories

Standard Accessories	Part number	Description
	01CR-82H000GT	LCR Meter
	82CR-82H00E01	User Manual CD
	82GW1SAFE0M01	Safety Instruction Sheet
	Region dependent	Power Cord
	LCR-06B	Test Fixture(Kelvin Clip)
Optional Accessories	Part number	Description
	LCR-05A	Test Fixture(DIP)
	LCR-07	Test Fixture(Clip)
	LCR-08	Test Fixture(SMD)
	LCR-10A	Test Fixture(SMD)
	LCR-15A	Test Fixture(SMD)
	DC BIAS BOX	External DC Bias box
	GTL-232	RS232C cable
	GTL-246	USB cable
	GTL-248	GPIB cable

Package Contents

Check the contents before using the instrument.

Opening
the box

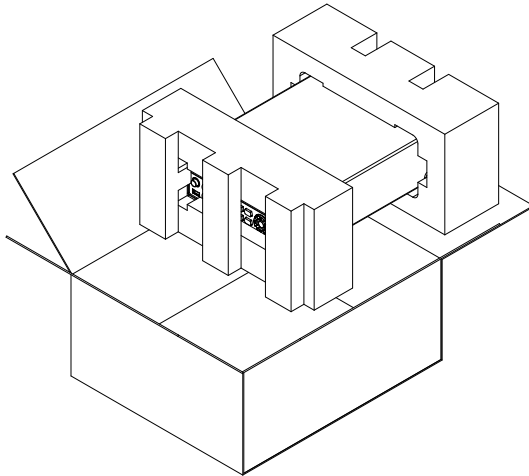

-
- | | | |
|---------------------------|------------------------------|------------------------------------|
| Contents
(single unit) | • Main unit | • Power cord x1 (region dependent) |
| | • Test Fixture (Kelvin Clip) | • User manual CD |
| | | • Safety instruction sheet |

Appearance

Front Panel

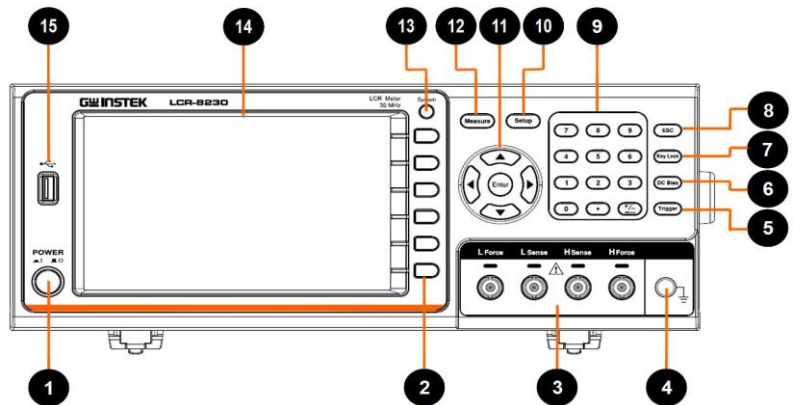

- | | | |
|---|-----------------|--|
| 1 | Power | This key is used to turn the device instrument on/off. |
| 2 | Function | For executing the function indicated for the position corresponding to the Function key.

Soft keys for use to select corresponding option which located on the right of the LCD screen. |
| 3 | Test terminals | Test terminals are used to connect test fixture. |
| 4 | Ground Terminal | This terminal is used for grounding. |
| 5 | Trigger | If trigger mode is set to external, this key can be used to measure trigger. |

- | | | |
|----|----------------------|--|
| 6 | DC BIAS | For control the Bias unit and for executing on/off. |
| 7 | Key Lock | The key will be locked to prevent from controlling the push key and the computer by both sides. To use the keypad again, press this key again. |
| 8 | ESC | Press this button to return the cursor to the top left corner of the currently displayed page or cancel current setting. |
| 9 | Numeric | The numeric keypad is used to input values for setting. |
| 10 | Setup | This key is used to enter setup page of the active mode, which includes Measure, Sweep and List modes. |
| 11 | Arrow Keys
/Enter | <p>The arrow keys are used to navigate the cursor on the screen.</p> <p>Enter key is used to confirm the value which input from the numeric keypad.</p> <p>When a flash drive is inserted from the USB port on the front panel. Press Enter to detecting USB disk and show USB disk management page.</p> |
| 12 | Measure | This key is used for entering the measurement display area page. |
| 13 | System | This key is used for entering system setup page. |
| 14 | LCD | 7" TFT- LCD display. |
| 15 | USB port | <p>It is an A-type USB port which only connects to USB flash disk for logging data.</p> <p>USB disk type: Flash drive only</p> <p>Format: FAT32/exFAT</p> <p>Max memory size: 128GB.</p> |

Rear Panel

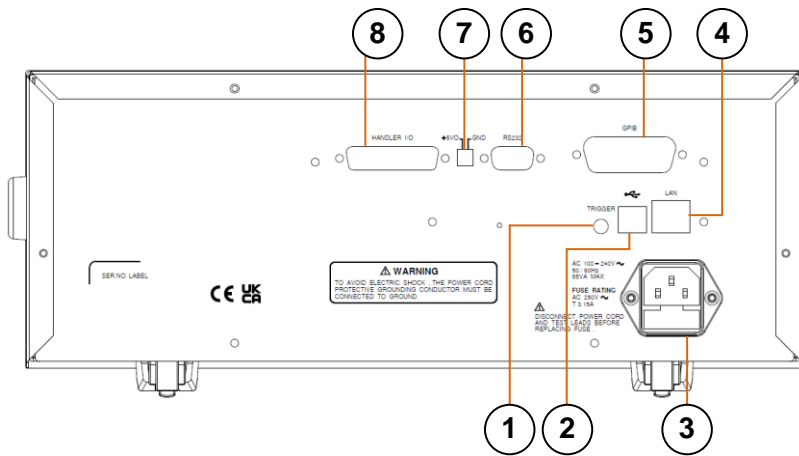

- | | | |
|---|-------------------|--|
| 1 | TRIGGER | Trigger input port |
| 2 | USB | USB port (Type B)
This port is used for remote control. |
| 3 | Power Cord Socket | Power Socket:
AC 100~240V, 50/60Hz, 65VA max |
| 4 | LAN | LAN port |
| 5 | GPIB | GPIB port |
| 6 | RS232 | RS-232 port |
| 7 | +5V Switch | +5V DC Power output switch |
| 8 | Handler I/O | Handler I/O port |

Set Up

Tilting the Stand

Lifting the instrument, starting from the front stand.

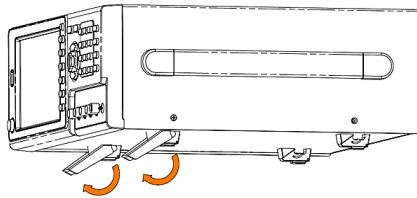

Horizontal
position

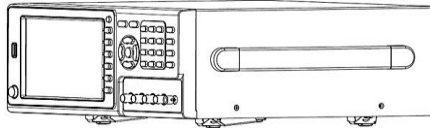

Tilt stand
position

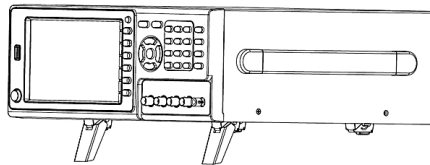

Carry position

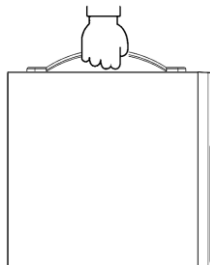

Power UP

Steps

1. Insert the AC power cord into the power socket.
2. Press the power button to turn the LCR-8200 series on.



3. The power button will Press down and the LCR-8200 series will start to boot up.



Connect to the test terminal

Background Please use the test fixture to connect to the test terminal for testing. Please follow the procedure below to connect.

Steps Please insert the test fixture into the terminal of the test equipment correctly.

1. Turn the left and right handles of the test fixture to turn the BNC notch to the top and align the BNC bumps of the test equipment.
2. Test the fixture into the BNC terminal of the test equipment.
3. Rotate the left and right handles of the test fixture to the right and push the test fixture to the end. As shown below.

Connection diagram

1.



2.

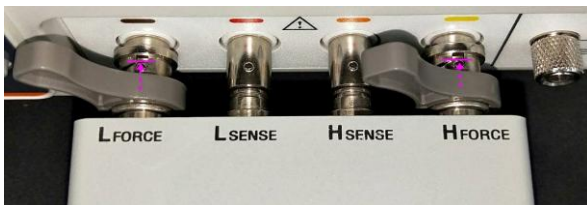

3.



! Note

Discharge capacitors before connecting them to the UNKNOWN terminal or a test fixture.

The maximum discharge withstand voltage, $1000 \text{ V} @ C < 2 \mu\text{F}$, $\sqrt{2/C} \text{ V} @ C \geq 2 \mu\text{F}$, is applicable to that the internal circuit remains protected if a charged capacitor is connected to the UNKNOWN terminal.

! Note

Avoid wrong connection, which would lead to incorrect reading value.

In order to ensure the accuracy of the instrument, please use the LCR-8200 optional accessories test cable for test.

! Warning

Before connecting the test leads, make sure the test leads are not connected to any component to avoid personal injury or damage to the instrument.

M EASURE (METER MODE)

In this chapter you will learn about all the measurement-related settings. All the measurement setting items can be found on the [MEAS DISPLAY] [MEASURE MODE SETUP] page.

Measure display area description	24
Setting parameter.....	25
Setting frequency.....	27
Setting speed.....	29
Setting trigger mode	30
Setting measurement level/ALC/RO	32
Setting DC bias.....	34
Setting measurement AC range.....	36
Setting measurement DC range	37
Setting trigger delay timer.....	38
Setting AC/DC delay timer.....	39
Setting average count	40
Setting display Vm/Im mode.....	41
Setting beep mode	42
Setting statistics mode	43
Setting comparator.....	44
Setting bin sorting.....	50
Setting FILE.....	56
Setting USB disk.....	58

Measure display area description

The measurement display is a Meter mode that provides a single condition for numerical measurements.



Available parameter	SWEEP	Sweep mode page. Provides the measurement value to graphic curve function.
	LIST SET	List setting page.
	LIST RUN	List run test page.
	CORR.	Correction page.

Setting parameter

Steps

1. Press the **Measure** button to enter [MEAS DISPLAY] page.



2. Use arrow keys to move the cursor and select **Parameter 1~4** item on the [MEAS DISPLAY] page.



3. Use option key on the right of the LCD screen to select a parameter for this measurement item.

Parameter	Ls	Equivalent Series Inductance
	Lp	Equivalent Parallel Inductance
	Cs	Equivalent Series Capacitance
	Cp	Equivalent Parallel Capacitance
	Rdc	DC Resistance
	Rs	Equivalent Series Resistance (ESR)
	Rp	Equivalent Parallel Resistance
	Z	Absolute value of impedance
	θ_{deg}	Phase angle of impedance(degree)
	θ_{rad}	Phase angle of impedance(radian)
	Q	Quality Factor, (Q = 1/D)
	D	Dissipation Factor, Loss coefficient (tan δ)

R	Resistance
X	Reactance
Y	Absolute value of admittance
G	Conductivity
B	Susceptance

**Note**

Up to four component parameters can be selected in the meter mode. The inductance and DCR values can be measured and displayed simultaneously.

When selecting Cs or Cp, the measured parameters including DCR will be discarded. That is, Cs/Cp and DCR are Not able to be measured simultaneously.

Setting frequency

The frequency range is 10Hz~1MHz/5MHz/10MHz/20MHz/30MHz/50MHz, and the resolution is set at 6 digits..

Steps

1. Press the **Measure** button to enter [MEAS DISPLAY] page.



2. Use arrow keys to move cursor and select **FREQ** item on the [MEAS DISPLAY] page.



3. Select option key on the right of the LCD screen to adjust the frequency value by rough or minor adjusting method or use the numeric keypad to enter the test frequency.

Available parameter

- ↑↑↑ Increase the first digit of the frequency value.

- ↑↑ Increase the second digit of the frequency value

- ↑ Increase the third digit of the frequency value

- ↓ Decrease the third digit of the frequency value

↓↓ Decrease the second digit of the frequency value

↓↓↓ Decrease the first digit of the frequency value

Setting speed

LCR-8200 Series offers 5 test speeds (SLOW2, SLOW, MED., FAST and MAX.). The slower the test, the more accurate and stable the test result.

Steps

1. Press the **Measure** button to enter [MEAS DISPLAY] page.



2. Use arrow keys to move cursor and select **SPEED** item on the [MEAS DISPLAY] page.



3. Use option key on the right of the LCD screen to select a test speed for this measurement item.

Available test speed

MAX.	2.5ms(>10kHz)
FAST	50ms(>20Hz)
MED.	100ms
SLOW	300ms
SLOW2	600ms

Setting trigger mode

LCR-8200 Series offers REPEAT and SINGLE mode.

Steps

1. Press the **Setup** button to enter [MEAS SETUP] page.



2. Use arrow keys to move cursor and select **TRIGGER** item on the [MEAS SETUP] page.



3. Use option key on the right of the LCD screen to select a trigger mode for this measurement item.

Available parameter

REPEAT Internal trigger mode is also known as continuous test. The trigger signal performs continuous test in accordance with the SPEED setting.

Press the Trigger button to pause the trigger to stop the measurement and display the “TRIG HOLD” message on

the top of the LCD. 

Again press the Trigger button to resume continuous triggering.

SINGLE External trigger mode, including Manual/Handler/TRIGGER Input/Remote control mode.

- Manual mode: The device performs a measurement once the Trigger button is pressed.
 - Handler mode: When a negative edge pulse is received from the handler interface on the rear panel, the device performs a measurement cycle.
 - TRIGGER Input mode: When a negative edge pulse is received from the TRIGGER Input on the rear panel, the device performs a measurement cycle.
 - Remote control mode: When a measurement command is sent from the RS-232 or USB or GPIB interface, the device performs a measurement cycle.
-

Setting measurement level/ALC/RO

LCR-8200 Series test signal voltage/current level can be set as the effective value (RMS value) of a sine wave of the test frequency from the unit's internal oscillator. The voltage range is 10mV-2Vrms and current range is 100uA-20mArms. 2Vrms can only be used at $\leq 1\text{MHz}$.

The ALC (automatic level control) feature adjusts the voltage across the DUT or the current through the DUT to match the voltage/current level setting. Using this feature, you can try to ensure a constant signal level (voltage or current) is applied to the DUT.

In situations when the actual measuring Vac or Iac goes beyond the extent that the ALC can regulate, a warning message, "ALC unable to regulate", will be shown at the bottom of the screen.



An asterisk will be shown beside the LEVEL V or A unit when the ALC is turned on.



The RO (output impedance) can be set to 25 Ω or 100 Ω .

The varied signal source output impedance will lead to the varied current or the difference of measuring value. If selecting $<25\Omega>$, then the voltage range is 10mV~1Vrms and the current range is 400uA~40mArms. If it needs to compare test results with Keysight select 100 Ω .

Steps

1. Press the **Measure** button to enter [MEAS DISPLAY] page.
2. Use arrow keys to move cursor and select **LEVEL** item on the [MEAS DISPLAY] page.



3. Use option key on the right of the LCD screen to adjust the level value or use the numeric keypad to enter the test level and select ALC/RO for this measurement item.

Available parameter	↑	Increase 0.1Vac/1mAac of the level value
	↓	Decrease 0.1Vac/1mAac of the level value
ALC OFF	ALC function turn off	ALC OFF Shown at the bottom of the screen.
ALC ON	ALC function turn on	ALC ON Shown at the bottom of the screen.
RO 100Ω	Set output impedance 100Ω	RO 100Ω Shown at the bottom of the screen.
RO 25Ω	Set output impedance 25Ω	RO 25Ω Shown at the bottom of the screen.

Setting DC bias

LCR-8200 Series offers DC BIAS $\pm 12V$. When input is above the instrument voltage range will be displayed “Out of range!”.



Steps

1. Press the **Measure** button to enter [MEAS DISPLAY] page.



2. Use arrow keys to move cursor and select **BIAS** item on the [MEAS DISPLAY] page.



3. Select option key on the right of the LCD screen to adjust the frequency value by rough or minor adjusting method or use the numeric keypad to enter the DC Bias voltage.

4. Press the DC Bias button to output the voltage and the DC Bias button will illuminate. When the DC Bias is output, the asterisk is displayed next to the BIAS V unit.



Available parameter	↑↑	Increase 1V of the DC Bias value
	↑	Increase 0.1V of the DC Bias value
	↓	Decrease 0.1V of the DC Bias value
	↓↓	Decrease 1V of the DC Bias value

Setting measurement AC range

The range recommendation is set to [Auto] for better measurement accuracy. The actual measured range will be displayed in the lower left corner of the screen.

When set to [HOLD], faster measurement speeds can be achieved. However, when the range is selected incorrectly, it will result in inaccurate or incorrect values.

Steps

1. Press the **Measure** button to enter [MEAS DISPLAY] page.



2. Use arrow keys to move the cursor to corresponding measurement AC range.



3. Use option key on the right of the LCD screen to select a desired measurement range.



Set up range mode	AUTO	The device will automatically select the best range to test.
	HOLD	The device will always performance test with a user-specified range.

Measurement range	1	Set 30Ω range
	2	Set 300Ω range
	3	Set 3kΩ range
	4	Set 30kΩ range

Setting measurement DC range

The range recommendation is set to [Auto] for better measurement accuracy. The actual measured range will be displayed in the lower center of the screen.

When set to [HOLD], faster measurement speeds can be achieved. However, when the range is selected incorrectly, it will result in inaccurate or incorrect values.

- | | |
|-------|---|
| Steps | <ol style="list-style-type: none"> 1. Press the Measure button to enter [MEAS DISPLAY] page.  2. Use arrow keys to move the cursor to corresponding measurement DC range.  |
|-------|---|
- 
3. Use option key on the right of the LCD screen to select a desired measurement range.

Set up range mode	<table border="0"> <tr> <td style="padding-right: 10px;">AUTO</td> <td>The device will automatically select the best range to test.</td> </tr> </table>	AUTO	The device will automatically select the best range to test.
AUTO	The device will automatically select the best range to test.		
	<table border="0"> <tr> <td style="padding-right: 10px;">HOLD</td> <td>The device will always performance test with a user-specified range.</td> </tr> </table>	HOLD	The device will always performance test with a user-specified range.
HOLD	The device will always performance test with a user-specified range.		
Measurement range	<table border="0"> <tr> <td style="padding-right: 10px;">1</td> <td>Set 30Ω range</td> </tr> </table>	1	Set 30Ω range
1	Set 30Ω range		
	<table border="0"> <tr> <td style="padding-right: 10px;">2</td> <td>Set 300Ω range</td> </tr> </table>	2	Set 300Ω range
2	Set 300Ω range		
	<table border="0"> <tr> <td style="padding-right: 10px;">3</td> <td>Set 3kΩ range</td> </tr> </table>	3	Set 3kΩ range
3	Set 3kΩ range		
	<table border="0"> <tr> <td style="padding-right: 10px;">4</td> <td>Set 30kΩ range</td> </tr> </table>	4	Set 30kΩ range
4	Set 30kΩ range		

Setting trigger delay timer

LCR-8200 Series can set the delay time before each test by setting trigger delay timer.

The delay time range is 0ms~5000ms.

Steps

1. Press the **Setup** button to enter [MEASURE MODE SETUP] page.



2. Use arrow keys to move cursor and select **TRIGGER DELAY** on the [MEASURE MODE SETUP] page.



3. Use key pad to input delay timer value ,unit is ms.

Setting AC/DC delay timer

LCR-8200 Series can set the AC/DC delay time when Rdc parameter enable .

The inductance and Rdc values can be measured and displayed simultaneously.

When the inductance is measured by Rdc, a current flows through the generated magnetic field. When the DC signal ends, the inductance will generate a back electromotive force. If the AC signal is subsequently sent out for measurement, the L value may cause an error. To avoid this problem, you can set the AC/DC delay timer to reduce the effect of back EMF on the measurement. This delay timer will be executed both AC to DC and DC to AC.

The delay time range is 0ms~5000ms.

Steps

1. Press the **Setup** button to enter [MEASURE MODE SETUP] page.
2. Use arrow keys to move cursor and select **AC/DC DELAY** on the [MEASURE MODE SETUP] page.



3. Use key pad to input delay timer value ,unit is ms.

Setting average count

This function is to perform multiple measurements and take an average result from multiple measurements as the final display value. The stability and reliability of the measurement results can be improved by utilizing this function. The number of measurements can be set from 1 to 64.

Steps

1. Press the **Setup** button to enter [MEASURE MODE SETUP] page.
2. Use arrow keys to move cursor and select **AVERAGE** on the [MEASURE MODE SETUP] page.



3. Use key pad to input average count value.



Note

This average count setting only works for the AC measurement parameters, and the DCR measurement does not perform the averaging function.

Setting display Vm/Im mode

The test signal voltage and test signal current of the AC and the test signal voltage and test signal current of the DC on the test object.

Turn on the Vm/Im display to help understand the setting status of ALC and RO.

Steps

1. Press the **Setup** button to enter [MEASURE MODE SETUP] page.



2. Use arrow keys to move cursor and select **DISPLAY Vm/Im** on the [MEASURE MODE SETUP] page.



3. Use option key on the right of the LCD screen to select a desired item.

Available parameter

OFF Turn off the Vm/Im display

ON Turn on the Vm/Im display

Setting beep mode

When the comparison function setting is turned on, the value judgment result will be indicated by color, and the buzzer function can be set to use the sound to know the measurement result.

Steps

1. Press the **Setup** button to enter [MEASURE MODE SETUP] page.



2. Use arrow keys to move cursor and select **BEEP WHEN** on the [MEASURE MODE SETUP] page.



3. Use option key on the right of the LCD screen to select a desired item.

Available parameter

OFF Turn off the beep function

PASS Buzzer sounds when the test pass

FAIL Buzzer sounds when the test fail

Setting statistics mode

When the comparison function setting is on, the statistics function can be turned on to calculate the measurement quantity of PASS and FAIL.

Steps

1. Press the **Setup** button to enter [MEASURE MODE SETUP] page.



2. Use arrow keys to move cursor and select **STATISTICS** on the [MEASURE MODE SETUP] page.



3. Use key pad to input average count value.

Available parameter

OFF Turn off the statistics display

ON Turn on the statistics display

CLEAR Clear statistics quantity

Setting comparator

In this section, user will learn how to set up comparator and bin sorting. The device can perform comparator function for 1~4 parameter simultaneously or separately. Choose to set the bin condition for each parameter, which can be divided into 2~9 classes. Bin methods include equalization, sequence, tolerance and random; limit value modes include measured values, tolerance values, and tolerance %.

Steps

1. Press the **Measure** button to enter [MEAS DISPLAY] page.



2. Use arrow keys to move cursor and select **COMP** item.



3. Use option key on the right of the LCD screen to select **COMP/BIN** item.

Set up comp mode

4. Use arrow keys to select **COMP MODE**.

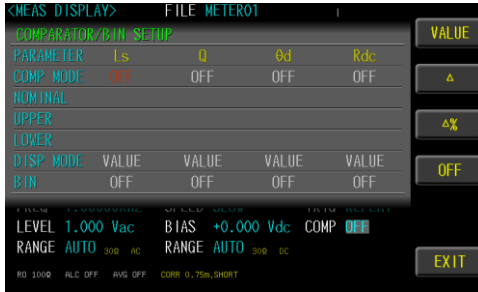

Available options

VALUE The measured values are compared. Select this mode, the **NOMINAL** field does not need to be set, just set the **UPPER** and **LOWER** upper and lower limits.

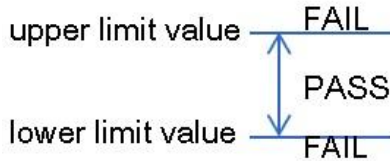

△ The difference between the measured value and the NOMINAL value is compared.

Absolute value (Δ) = measure value - nominal value

Select this mode, the NOMINAL value and UPPER and LOWER upper and lower limits must be set.

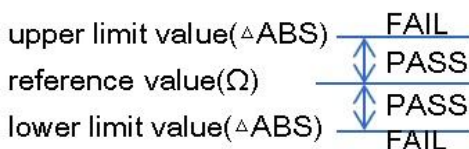

$\Delta\%$ The difference between the measured value and the NOMINAL value is compared with the percentage of the NOMINAL value.

Deviation percentages ($\Delta\%$) = Absolute value (Δ)/nominal value \times 100%

Select this mode, the NOMINAL value and UPPER and LOWER upper and lower limits must be set.

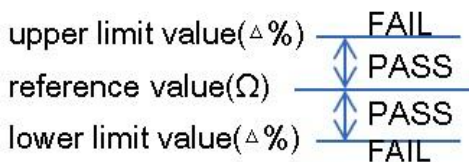

OFF Turn off the comparator function

Set up nominal/upper/lower

1. Use arrow keys to move cursor and select **NOMINAL** or **UPPER** and **LOWER**.



2. Use key pad to input value and unit.

Available options	NOMINAL	Compare nominal values. Set only in the Δ and $\Delta\%$ modes.
	UPPER	Comparison of upper limit
	LOWER	Comparison of lower limit

Set up display mode

3. Use arrow keys to move cursor and select **DISP MODE**.

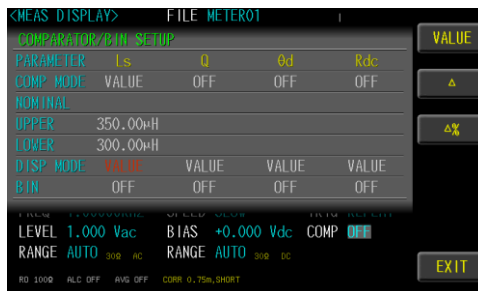

Available options	VALUE	Display measurement value
-------------------	-------	---------------------------

△ Display the difference between the measured value and the NOMINAL value

△% Display the difference between the measured value and the NOMINAL value is compared with the percentage of the NOMINAL value.

Comparator result display

4. Press the **Measure** button to enter [MEAS DISPLAY] page. Comparator result is Pass in green color or Fail in red color.



Set up other Parameter

5. Use the above steps to set other fields.



Comparator
result display

6. Press the **Measure** button to enter [MEAS DISPLAY] page. Comparator result is Pass in green color or Fail in red color.



Setting bin sorting

Choose to set the bin condition for each parameter, which can be divided into 2~9 classes. Bin methods include equalization, sequence, tolerance and random; limit value modes include measured values, tolerance values, and tolerance %.

Steps

1. Use arrow keys to move cursor and select **BIN** item.



2. Use option key on the right of the LCD screen to select a desired item.

Available options

OFF Turn off the bin function.

ON Turn on the bin function. The **SET BIN** option will be displayed.

SET BIN Set the parameters of the bin function.

Set up parameter 3. Use arrow keys to select **PARAMETER** item.



4. Use option key on the right of the LCD screen to select a desired item. The **MEAS DISPLAY** has selected parameters to have display options.

Available options	Off	Turn off the bin function.
PARA1(Ls)		Select the first measurement parameter (Ls).
PARA2(Q)		Select the second measurement parameter (Q).
PARA3(@d)		Select the third measurement parameter (@d).
PARA4(Rdc)		Select the fourth measurement parameter (Rdc).

Set up bin number

- Use arrow keys to move cursor and select **BIN NUMBER** item.

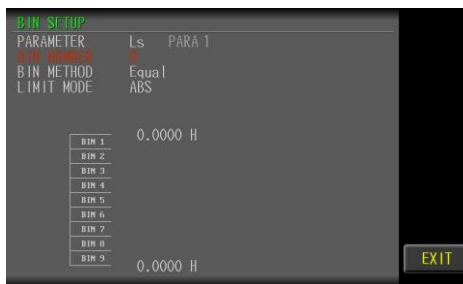

- Use key pad to input bin number value.(2~9)

Set up bin method

- Use arrow keys to move cursor and select **BIN METHOD** item.

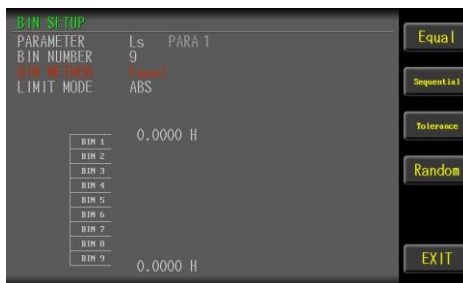

- Use option key on the right of the LCD screen to select a desired item.

Available options Equal Sort by equally average. Set the high/low value.

Equal/Sequential Mode

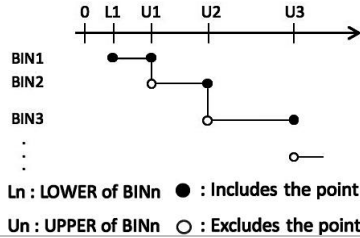

Sequential Sort by order. Set each value.

Tolerance Sort by order. Set each value.

Tolerance Mode

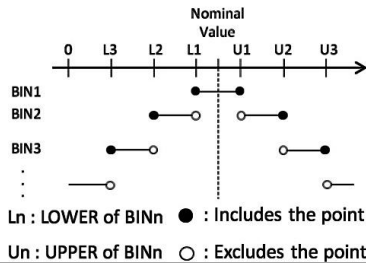

Random Sort by user. Set each range value.

Random Mode

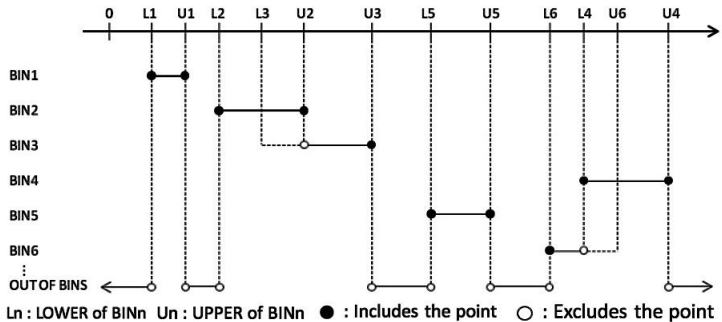

Set up limit mode 11. Use arrow keys to move cursor and select **LIMIT MODE**.

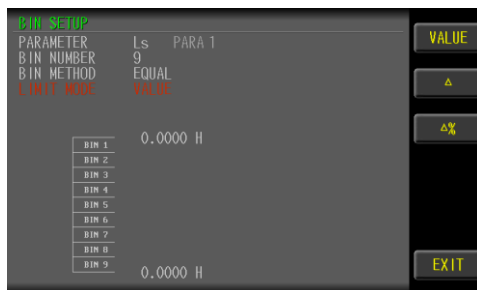

12. Use option key on the right of the LCD screen to select a desired item.

Available options **VALUE** The measured values are compared. Select this mode, the **NOMINAL** field does not need to be set, just set the **UPPER** and **LOWER** upper and lower limits.

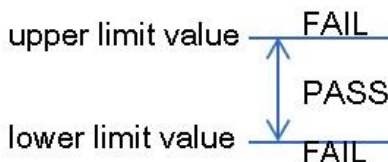

Δ The difference between the measured value and the NOMINAL value is compared.

Absolute value (Δ) = measure value - nominal value

Select this mode, the NOMINAL value and UPPER and LOWER upper and lower limits must be set.

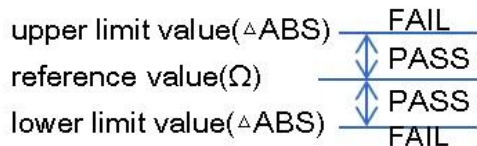

$\Delta\%$ The difference between the measured value and the NOMINAL value is compared with the percentage of the NOMINAL value.

Deviation percentages ($\Delta\%$) = Absolute value (Δ)/nominal value \times 100%

Select this mode, the NOMINAL value and UPPER and LOWER upper and lower limits must be set.

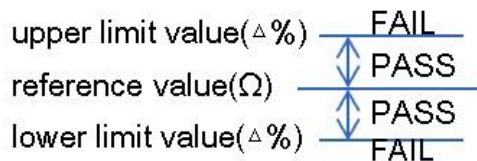

Setting FILE

The parameter can be saved in the flash Memory of the instrument. The meter mode allows the user to access 99 setup groups.

Steps

1. Press the **Measure** button to enter [MEASURE DISPLAY] page.



2. Use arrow keys to move cursor and select FILE on the [MEASURE DISPLAY] page.



3. Use option key on the right of the LCD screen to select **FILE** item.

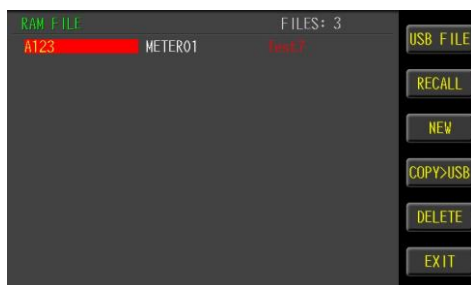

4. Use option key on the right of the LCD screen to select a desired item.

Available parameter	RECALL	load the files in the temporary files for testing
	NEW	Open an empty file and setting the file name
	SAVE AS	Save the test file in the RAM to another file.
	DELETE	Delete the file, the file which is being used (red) cannot delete.



Note

The LCR-8200 uses the system's temporary files for testing.

Use "RECALL" to load the files in the instrument memory into the temporary files of the system.

The file font being used is red and cannot be deleted. Any parameter change settings will be saved in the original file instantly.

USB disks can only back up test files. If you want to use this file, you need to copy the file to the instrument memory using "COPY> RAM" and then load it.

Setting USB disk

USB disk can store test setup files and LCD screen images and SWEEP measurement curves and magnitude data.

Available types and file formats:

USB disk type: Flash disk only.

Format: FAT32 / exFAT.

Max memory size: 128GB.

- Steps
1. Insert a USB disk for using as data recoding. The instrument will automatically detect the USB disk format. When it is available, the USB menu will pop up.



2. Use option key on the right of the LCD screen to select a desired item. When the USB disk is plugged in, you can press the ENTER button to pop up the USB menu.



Available options

Save screen

Save LCD screen images to USB disk.
Path>

USB:\LCR8200\SCREEN\SCNxxxx.BMP



File management

USB file management.

Path> USB:\LCR8200\METER

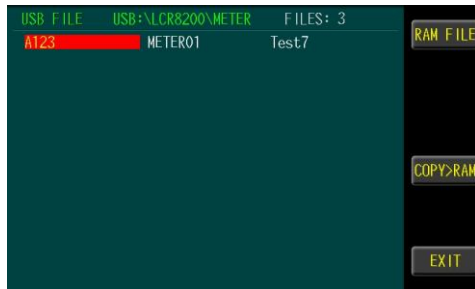

Format USB drive

Format the USB disk(FAT32)



SWEEP (GRAPH MODE)

In this chapter you will learn about all the sweep-related settings. All the sweep items can be found on the [SWEEP DISPLAY] [SWEEP MODE SETUP] page.

Sweep display area description	61
Setting type	62
Setting X-axis	63
Setting start	64
Setting stop	65
Setting level/freq	66
Setting bias/level	67
Setting trig	68
Setting speed	70
Setting scale	71
Setting func	72
Setting para	73
Setting Y-axis	74
Setting ref	75
Setting pos	76
Setting div/decade	77
Setting ANALYSIS (option)	78
Setting R0/R1/L1/C1 (option)	79
Setting sweep delay	80
Setting output impedance	81
Setting keep previous trace	82
Setting trace A/B color	84
Setting trace A/B simulation color (option)	85
Setting USB disk	86

Sweep display area description

The sweep display is a sweep graph mode that provides a sweep range condition for graph measurements.

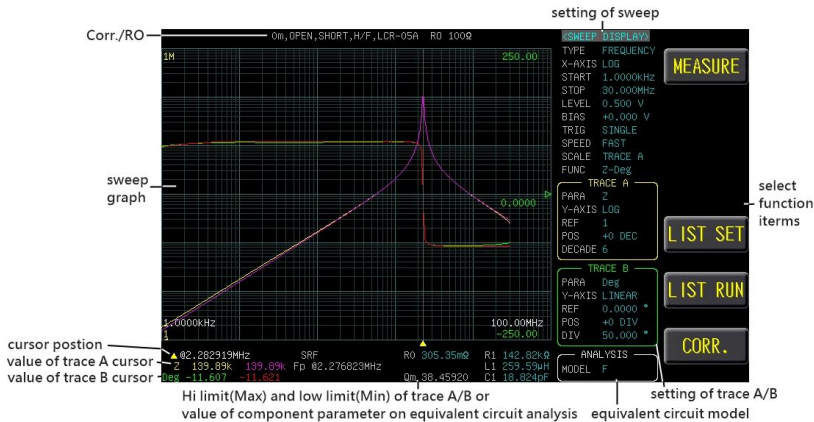

Available parameter

MEASURE Measure meter mode page.

LIST SET List setting page.

LIST RUN List run test page.

CORR. Correction page.



When it is under Sweep mode, the SPOT LOAD correction setting will not activate.

Setting type

Sweep type has 4 kinds, which are frequency, Vac, Iac and DC BIAS.

Steps

1. Press the **Measure** button to enter [MEAS DISPLAY] page, and then press the **SWEEP** function button on the right side of the LCD to enter the [SWEEP DISPLAY] page.



2. Use arrow keys to move the cursor and select **TYPE** item on the [SWEEP DISPLAY] page.

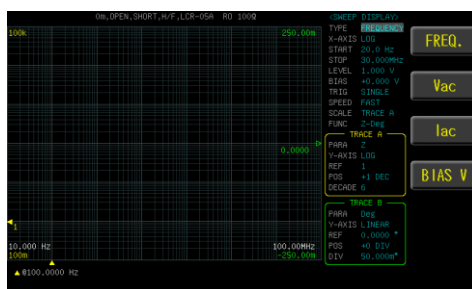

3. Use option key on the right of the LCD screen to select a parameter for this sweep item.

Available parameter

FREQ.	Change frequency range sweep condition
Vac	Change Vac range sweep condition
Iac	Change Iac range sweep condition
DC BIAS	Change DC BIAS range sweep condition

Setting X-axis

The X-axis scale shows 2 modes LINEAR and LOG.

Steps

1. Press the **Measure** button to enter [MEAS DISPLAY] page, and then press the **SWEEP** function button on the right side of the LCD to enter the [SWEEP DISPLAY] page.
2. Use arrow keys to move cursor and select **X-AXIS** item on the [SWEEP DISPLAY] page.

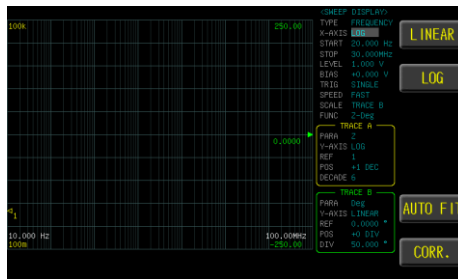

3. Use option key on the right of the LCD screen to select a parameter for this sweep item.

Available parameter	LINEAR	The starting value to the ending value, equal to 251 points
	LOG	The starting value to the ending value, use the logarithm to distinguish 267 points (maximum). Different points depending on the status of the range setting
	AUTO FIT	Automatically adjust the Y-axis scale and position of the sweep graph

Setting start

Sweep test condition start value. (frequency, Vac, Iac and DC BIAS)

Steps

1. Press the **Measure** button to enter [MEAS DISPLAY] page, and then press the **SWEEP** function button on the right side of the LCD to enter the [SWEEP DISPLAY] page.



2. Use arrow keys to move the cursor and select **START** item on the [SWEEP DISPLAY] page.

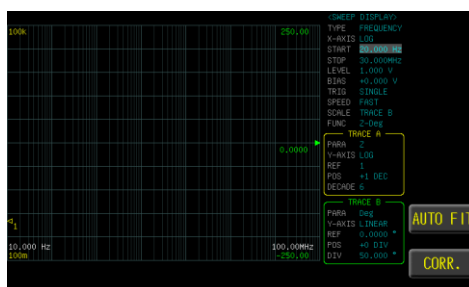

3. Use the numeric keypad to enter the test frequency (Vac or Iac or DC BIAS) and unit.

Setting stop

Sweep test condition stop value. (frequency, Vac, Iac and DC BIAS)

Steps

1. Press the **Measure** button to enter [MEAS DISPLAY] page, and then press the **SWEEP** function button on the right side of the LCD to enter the [SWEEP DISPLAY] page.
2. Use arrow keys to move the cursor and select **STOP** item on the [SWEEP DISPLAY] page.

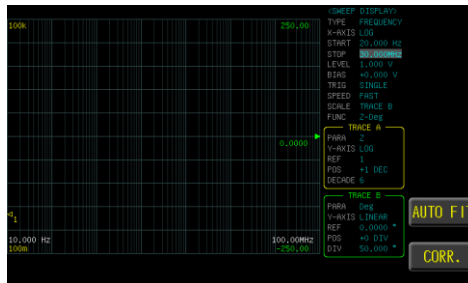

3. Use the numeric keypad to enter the test frequency (Vac or Iac or DC BIAS) and unit.

Setting level/freq

When performing a frequency sweep test, you need to set the test voltage/current (Vac/Iac). If you are performing a voltage/current/DC BIAS scan test, you need to set the test frequency. The voltage range is 10mV-2Vrms and current range is 0.1mA-20mArms. 2Vrms can only be used at <= 1MHz.

Steps

1. Press the **Measure** button to enter [MEAS DISPLAY] page, and then press the **SWEEP** function button on the right side of the LCD to enter the [SWEEP DISPLAY] page.



2. Use arrow keys to move the cursor and select **LEVEL/FREQ** item on the [SWEEP DISPLAY] page.

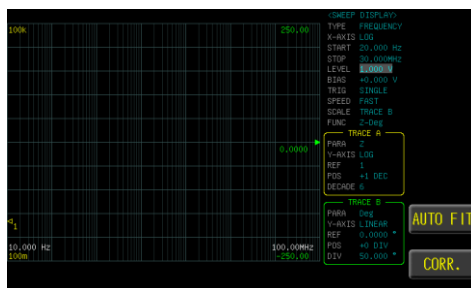

3. Use the numeric keypad to enter the test Vac/Iac (frequency) or Freq. (Vac/Iac/DC BIAS) and unit.

Setting bias/level

When performing a **FREQ./Vac/Iac** sweep test, you need to set the test DC BIAS. If you are performing a DC BIAS scan test, you need to set the test voltage/current (Vac/Iac).

LCR-8200 Series offers DC BIAS $\pm 12V$. BIAS has a set value, when the trigger test starts, DC BIAS will automatically turn on the output, and the DC BIAS button indicator will light up; at the end of the test, DC BIAS will automatically turn off and the light will be off.

When input is above the instrument voltage range will be displayed

“Out of range!”. 

Steps

1. Press the **Measure** button to enter [MEAS DISPLAY] page, and then press the **SWEEP** function button on the right side of the LCD to enter the [SWEEP DISPLAY] page.



2. Use arrow keys to move the cursor and select **BIAS/LEVEL** item on the [SWEEP DISPLAY] page.

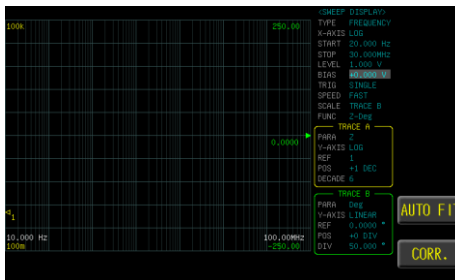

3. Use the numeric keypad to enter the test DC BIAS or Vac/Iac and unit.

Setting trig

Trig mode has REPEAT and SINGLE mode. Press the Trigger button to start the sweep test once.

Steps

1. Press the **Measure** button to enter [MEAS DISPLAY] page, and then press the **SWEEP** function button on the right side of the LCD to enter the [SWEEP DISPLAY] page.
2. Use arrow keys to move the cursor and select **TRIG** item on the [SWEEP DISPLAY] page.

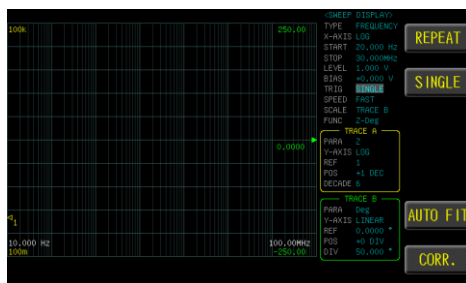

3. Use option key on the right of the LCD screen to select a trigger mode for this sweep item.

Available parameter

REPEAT Continuous sweep test. Press the **STOP** function button on the right side of the LCD to stop the SWEEP test.



SINGLE External trigger mode, including Manual/Handler/TRIGGER

Input/Remote control mode.

- Manual mode: The device performs a sweep test once the Trigger button is pressed.
 - Handler mode: When a negative edge pulse is received from the handler interface on the rear panel, the device performs a sweep test cycle.
 - TRIGGER Input mode: When a negative edge pulse is received from the TRIGGER Input on the rear panel, the device performs a sweep test cycle.
 - Remote control mode: When a measurement command is sent from the RS-232 or USB or GPIB interface, the device performs a sweep test cycle.
-

Setting speed

3 test speeds (SLOW, MED., FAST). The slower the test, the more accurate and stable the test result.

Steps

1. Press the **Measure** button to enter [MEAS DISPLAY] page, and then press the **SWEEP** function button on the right side of the LCD to enter the [SWEEP DISPLAY] page.



2. Use arrow keys to move the cursor and select **SPEED** item on the [SWEEP DISPLAY] page.

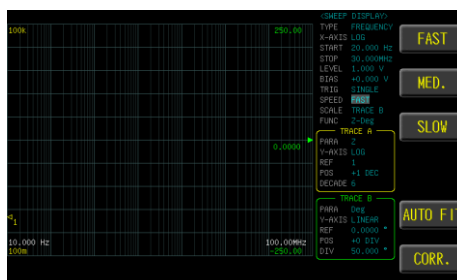

3. Use option key on the right of the LCD screen to select a speed mode for this sweep item.

Available test speed

FAST 2.5ms (>10kHz)

MED. 50ms (>20Hz)

SLOW 100ms

Setting scale

The scale of the Y-axis is displayed with the setting of trace A or trace B.

Steps

1. Press the **Measure** button to enter [MEAS DISPLAY] page, and then press the **SWEEP** function button on the right side of the LCD to enter the [SWEEP DISPLAY] page.



2. Use arrow keys to move the cursor and select **SCALE** item on the [SWEEP DISPLAY] page.

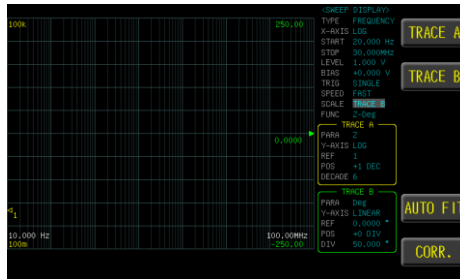

3. Use option key on the right of the LCD screen to select a scale type for this sweep item.

Available parameter

TRACE A	Adjust with the trace A setting
TRACE B	Adjust with the trace B setting
AUTO FIT	Automatically adjust the Y-axis scale and position of the sweep graph

Setting func

Select the combination of parameters to be sweep test.

Func1-16: Z-Deg, Y-Deg, R-X, G-B, Z-Cs, Z-Cp, Z-Ls, Z-Lp, Cs-Rs, Cp-Rp, Cp-G, Cs-D, Ls-Rs, Lp-Rp, Lp-G, Ls-Q.

FUNC selection If you do not have the desired test parameters, you can go to the PARA item of TRACE A/B and select the required test parameters.

Steps

1. Press the **Measure** button to enter [MEAS DISPLAY] page, and then press the **SWEEP** function button on the right side of the LCD to enter the [SWEEP DISPLAY] page.



2. Use arrow keys to move the cursor and select **FUNC** item on the [SWEEP DISPLAY] page.

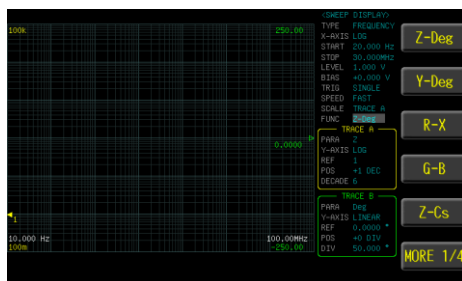

3. Use option key on the right of the LCD screen to select a function type for this sweep item.

Setting para

Select test parameters of trace A or trace B.

Steps

1. Press the **Measure** button to enter [MEAS DISPLAY] page, and then press the **SWEEP** function button on the right side of the LCD to enter the [SWEEP DISPLAY] page.



2. Use arrow keys to move the cursor and select **PARA** item on the [SWEEP DISPLAY] page.

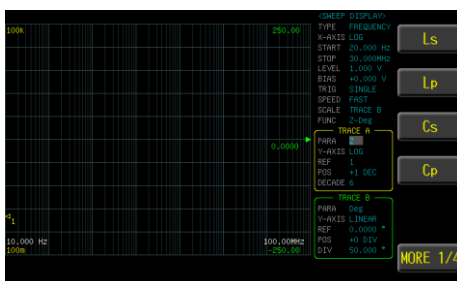

3. Use option key on the right of the LCD screen to select a parameter for this sweep item.

Setting Y-axis

The Y-axis scale shows 2 modes LINEAR and LOG of trace A or trace B.

Steps

1. Press the **Measure** button to enter [MEAS DISPLAY] page, and then press the **SWEEP** function button on the right side of the LCD to enter the [SWEEP DISPLAY] page.
2. Use arrow keys to move cursor and select **Y-AXIS** item on the [SWEEP DISPLAY] page.

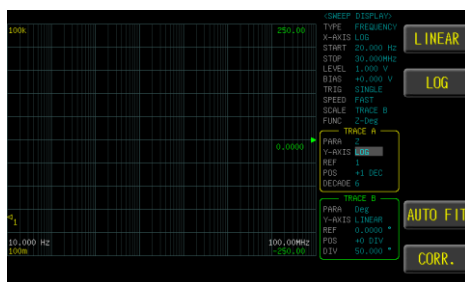

3. Use option key on the right of the LCD screen to select a parameter for this sweep item.

Available parameter

LINEAR	The starting value to the ending value, equal to 400 points
LOG	The starting value to the ending value, use the logarithm to distinguish 400 points (maximum). Different points depending on the status of the range setting
AUTO FIT	Automatically adjust the Y-axis scale and position of the sweep graph

Setting ref

Set the Y-axis reference point scale for trace A or B. This parameter can be set by selecting LINEAR in Y-axis.

Steps

1. Press the **Measure** button to enter [MEAS DISPLAY] page, and then press the **SWEEP** function button on the right side of the LCD to enter the [SWEEP DISPLAY] page.
2. Use arrow keys to move the cursor and select **REF** item on the [SWEEP DISPLAY] page.

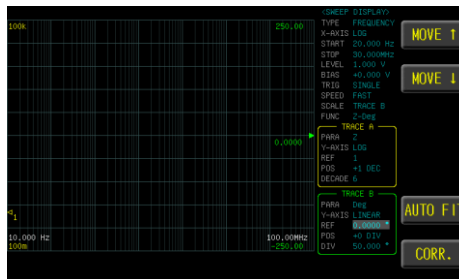

3. Use option key on the right of the LCD screen to select a scale type for this sweep item.

Available parameter

MOVE↑	Reference point scale is adjusted downwards
MOVE↓	Reference point scale is adjusted upwards
AUTO FIT	Automatically adjust the Y-axis scale and position of the sweep graph

Setting pos

Move the graphic of trace A or trace B.

Steps

1. Press the **Measure** button to enter [MEAS DISPLAY] page, and then press the **SWEEP** function button on the right side of the LCD to enter the [SWEEP DISPLAY] page.



2. Use arrow keys to move the cursor and select **POS** item on the [SWEEP DISPLAY] page.

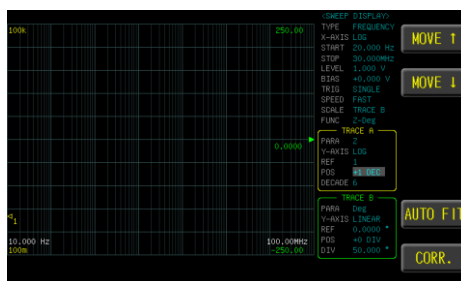

3. Use option key on the right of the LCD screen to select a scale type for this sweep item.

Available parameter

MOVE↑ Move the sweep graphic up

MOVE↓ Move the sweep graphic down

AUTO FIT Automatically adjust the Y-axis scale and position of the sweep graph

Setting div/decade

The scale of the Y-axis is displayed with the setting of trace A or trace B.

Steps

1. Press the **Measure** button to enter [MEAS DISPLAY] page, and then press the **SWEEP** function button on the right side of the LCD to enter the [SWEEP DISPLAY] page.



2. Use arrow keys to move the cursor and select **DIV (LINEAR)** or **DECADE (LOG)** item on the [SWEEP DISPLAY] page.

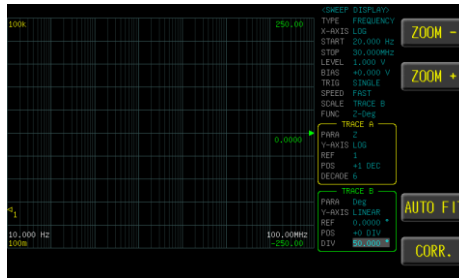

3. Use option key on the right of the LCD screen to select a scale type for this sweep item.

Available parameter

ZOOM-	Scale of each interval becomes larger
ZOOM+	Scale of each interval becomes smaller
AUTO FIT	Automatically adjust the Y-axis scale and position of the sweep graph

Setting analysis (option)

Select the equivalent circuit model. The equivalent circuit analysis function estimates equivalent circuit constant based on measurement results. It can estimate 3-element model and 4-element model. By using the simulation function, you can display frequency characteristic ideal values using estimation results or user-configured constants. For more details, refer to page 274.

Steps

1. Press the **Measure** button to enter [MEAS DISPLAY] page, and then press the **SWEEP** function button on the right side of the LCD to enter the [SWEEP DISPLAY] page.
2. Use arrow keys to move cursor and select **ANALYSIS** item on the [SWEEP DISPLAY] page.

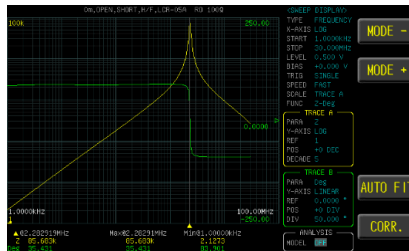

3. Use option key on the right of the LCD screen to select the appropriate equivalent circuit model.

Available parameter

- | | |
|----------|---|
| MODE- | Reverse select the equivalent circuit model (OFF>G>F>E>D>C>B>A) |
| MODE+ | Forward select the equivalent circuit model (OFF>A>B>C>D>E>F>G) |
| AUTO FIT | Automatically adjust the Y-axis scale and position of the sweep graph |

Setting R0/R1/L1/C0/C1 (option)

Calculate the analyzed value of obtained unit in accordance with the equivalent circuit model. Can use <↑>, <↑>, <↓>, <↓> for fine adjustment or input the required value with the numeric keyboard to adjust the simulate equivalent circuit and sweep frequency curve. For more details, refer to page 274.

Steps

1. Press the **Measure** button to enter [MEAS DISPLAY] page, and then press the **SWEEP** function button on the right side of the LCD to enter the [SWEEP DISPLAY] page.



2. Use arrow keys to move the cursor and select **R0/R1/L1/C1** item on the [SWEEP DISPLAY] page.

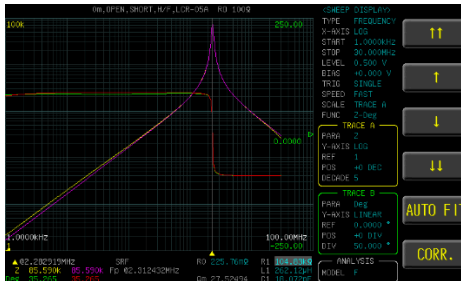

3. Use option key on the right of the LCD screen to adjust the value.

Available parameter	↑↑	Increase a lot of value
	↑	Increase small of value
	↓	Decrease small of value
	↓↓	Decrease a lot of value
AUTO FIT		Automatically adjust the Y-axis scale and position of the sweep graph

Setting sweep delay

Set the sweep test the delay time between each test point and point. The delay time range is 0ms~500ms.

Steps

1. Press the **Measure** button to enter [MEAS DISPLAY] page, and then press the **SWEEP** function button on the right side of the LCD to enter the [SWEEP DISPLAY] page, and press the **Setup** button to enter [SWEEP MODE SETUP] page.



2. Use arrow keys to move the cursor and select **SWEEP DELAY** item on the [SWEEP MODE SETUP] page.

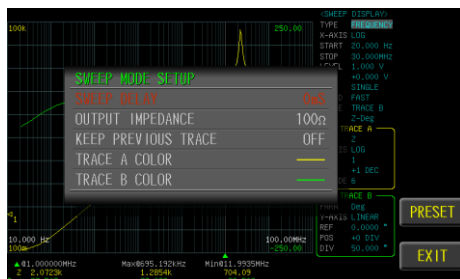

3. Use the numeric keypad to enter the time (ms).

Setting output impedance

The output impedance can be set to 25Ω or 100Ω.

The varied signal source output impedance will lead to the varied current or the difference of measuring value. If selecting <25Ω>, then the voltage range is 10mV~1Vrms and the current range is 400μA~40mArms.

If need to compare test results with Keysight select 100Ω.

Steps

1. Press the **Measure** button to enter [MEAS DISPLAY] page, and then press the **SWEEP** function button on the right side of the LCD to enter the [SWEEP DISPLAY] page, and press the **Setup** button to enter [SWEEP MODE SETUP] page.
2. Use arrow keys to move the cursor and select **OUTPUT IMPEDANCE** item on the [SWEEP MODE SETUP] page.

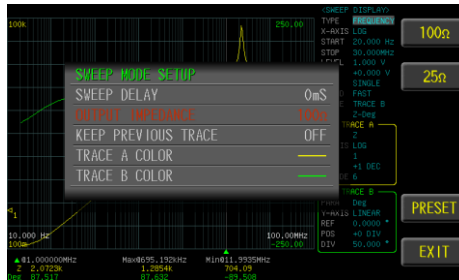

3. Use the numeric keypad to enter the time (ms).

Available parameter

100Ω Set output impedance to 100Ω

25Ω Set output impedance to 25Ω

Setting keep previous trace

Save sweep graph for part alignment or adjustment. When ANALYSIS item is activated, this setting will be invalid automatically.

Steps

1. Press the **Measure** button to enter [MEAS DISPLAY] page, and then press the **SWEEP** function button on the right side of the LCD to enter the [SWEEP DISPLAY] page, and press the **Setup** button to enter [SWEEP MODE SETUP] page.



2. Use arrow keys to move the cursor and select **KEEP PREVIOUS TRACE** item on the [SWEEP MODE SETUP] page.

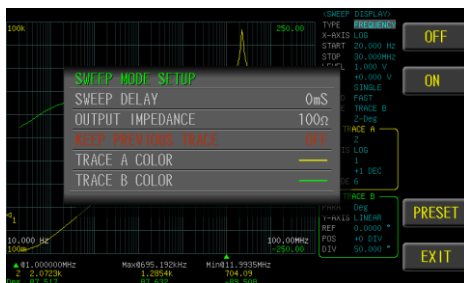

3. Use option key on the right of the LCD screen to select a desired item.

Available parameter	OFF	Save sweep graph turn off
	ON	Save sweep graph turn on

Function Description Multiple parts are compared to the measurement curve, this function can be turned on, and the parts are measured in order to understand the difference.

A single part or circuit can be measured before adjustment. Turn on this function and adjust it after making adjustments to understand the difference in adjustment.

Use the **CLEAR** function key to clear the all graph.

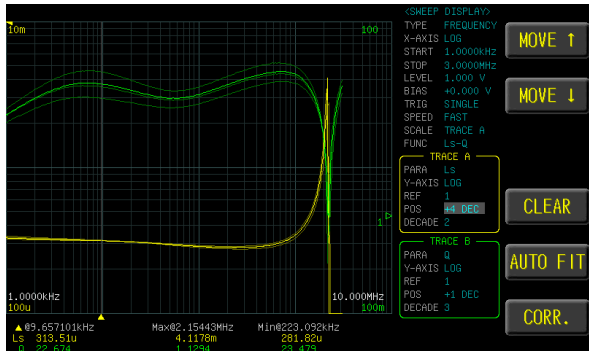

Setting trace A/B color

Set the display color of trace A or trace B.

Steps

1. Press the **Measure** button to enter [MEAS DISPLAY] page, and then press the **SWEEP** function button on the right side of the LCD to enter the [SWEEP DISPLAY] page, and press the **Setup** button to enter [SWEEP MODE SETUP] page.
2. Use arrow keys to move the cursor and select **TRACE A/B COLOR** item on the [SWEEP MODE SETUP] page.

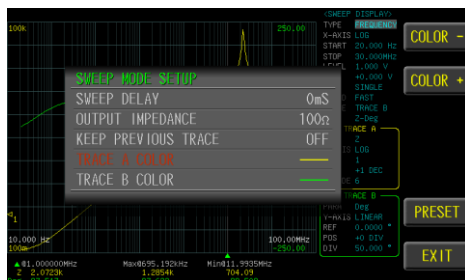

3. Use option key on the right of the LCD screen to select a desired color.

Available parameter

COLOR- Adjust color down

COLOR+ Adjust color up

Setting trace A/B simulation color (option)

Set the display color of trace A or trace B simulation.

Steps

1. Press the **Measure** button to enter [MEAS DISPLAY] page, and then press the **SWEEP** function button on the right side of the LCD to enter the [SWEEP DISPLAY] page, and press the **Setup** button to enter [SWEEP MODE SETUP] page.
2. Use arrow keys to move the cursor and select **TRACE A/B SIMULATION COLOR** item on the [SWEEP MODE SETUP] page.

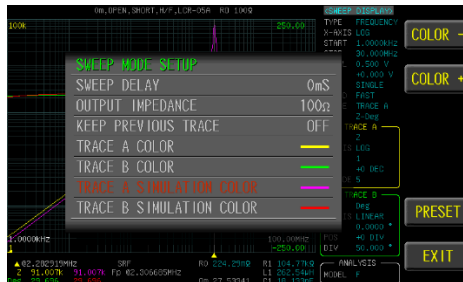

3. Use option key on the right of the LCD screen to select a desired color.

Available parameter

COLOR – Adjust color down

COLOR + Adjust color up

Setting USB disk

USB disk can store test setup files and LCD screen images and SWEEP measurement curves and magnitude data.

Available types and file formats:

USB disk type: Flash disk only.

Format: FAT32 / exFAT.

Max memory size: 128GB.

- Steps
1. Insert a USB disk for using as data recording. The instrument will automatically detect the USB disk format. When it is available, the USB menu will pop up.



2. Use option key on the right of the LCD screen to select a desired item. When the USB disk is plugged in, you can press the ENTER button to pop up the USB menu.

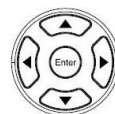

Available options	<p>Save screen</p> <p>Save LCD screen images to USB disk.</p> <p>Path></p> <p>USB:\LCR8200\SCREEN\SCNxxxx.BMP</p>
-------------------	--



Save sweep graphic	<p>Save sweep graph to USB disk.</p> <p>Path></p> <p>USB:\LCR8200\SWEEP\SWPxxxx.BMP</p>
--------------------	--



Save sweep data	<p>Save sweep measure data to USB disk.</p> <p>Path></p> <p>USB:\LCR8200\SWEEP\SWPxxxx.CSV</p>
-----------------	---



Format USB drive	<p>Format the USB disk(FAT32)</p>
------------------	-----------------------------------



LIST (MULTI STEP MODE)

In this chapter you will learn about all the list-related settings. All the list setting items can be found on the [LIST SET] [LIST MODE SETUP] [LIST RUN] page.

LIST SET/LIST RUN display area description	89
Setting step	90
Setting parameter	92
Setting frequency	94
Setting level	95
Setting DC bias	96
Setting speed.....	97
Setting delay	98
Setting comp mode	99
Setting trigger mode	103
Setting trigger delay	106
Setting AUTO TRIG THRESHOLD	107
Setting OUTPUT IMPEDANCE.....	109
Setting ALC.....	110
Setting beep when.....	111
Setting range hold.....	112
Setting fail reset	113
Setting statistics.....	114
Setting bin sorting.....	115
Setting FILE.....	121
Setting USB disk.....	123

LIST SET/LIST RUN display area description

The list measurement display is a multi-step mode that provides simultaneous multi-condition measurement for the part.

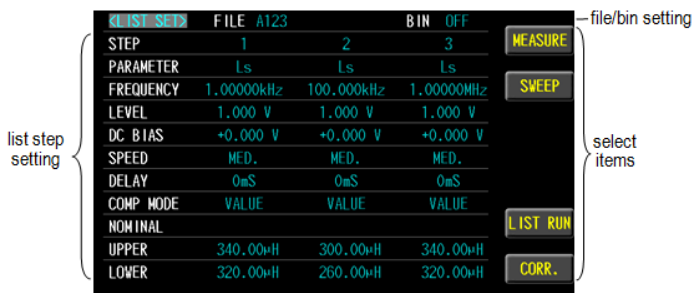

Available parameter

MEASURE Meter mode page

SWEEP Sweep mode page.

LIST RUN List run test page

CORR. Correction page

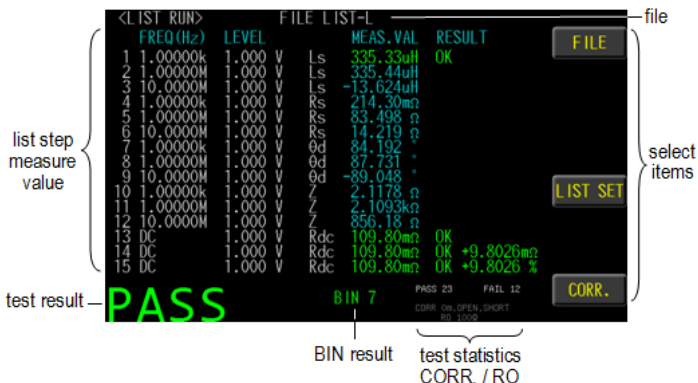

Available parameter

FILE List file management

LIST SET List setting page

CORR. Correction page

Setting step

LIST SET has 15 steps to set.

Steps

1. Press the **Measure** button to enter [MEAS DISPLAY] page, and then press the **LIST SET** function button on the right side of the LCD to enter the [LIST SET] page.



2. Use arrow keys to move cursor and select **STEP** item on the [LIST SET] page.

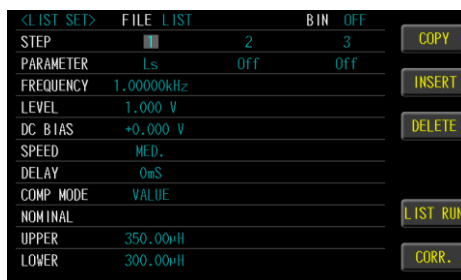

3. Use option key on the right of the LCD screen to select a desired item.

Available parameter

COPY

Copy the cursor where the step is added to the next step.

Copy setp1 to setp2.

<LIST SET>	FILE	LIST	BIN	OFF	
STEP	1	2	3		COPY
PARAMETER	Ls	Ls	Off	Off	
FREQUENCY	1.00000kHz	1.00000kHz			INSERT
LEVEL	1.000 V	1.000 V			
DC BIAS	+0.000 V	+0.000 V			DELETE
SPEED	MED.	MED.			
DELAY	0mS	0mS			
COMP MODE	VALUE	VALUE			
NOM INAL					LIST RUN
UPPER	350.00uH	350.00uH			
LOWER	300.00uH	300.00uH			CORR.

INSERT

Insert a blank step in the cursor step to the next step.

Insert blank step in the next step of step1.

<LIST SET>	FILE	LIST	BIN	OFF	
STEP	1	2	3		COPY
PARAMETER	Ls	Off	Ls		
FREQUENCY	1.00000kHz		1.00000kHz		INSERT
LEVEL	1.000 V		1.000 V		
DC BIAS	+0.000 V		+0.000 V		DELETE
SPEED	MED.		MED.		
DELAY	0mS		0mS		
COMP MODE	VALUE		VALUE		
NOM INAL					LIST RUN
UPPER	350.00uH		350.00uH		
LOWER	300.00uH		300.00uH		CORR.

DELETE

Delete the cursor step.

Delete step3

<LIST SET>	FILE	LIST	BIN	OFF	
STEP	1	2	3		COPY
PARAMETER	Ls	Off	Off		
FREQUENCY	1.00000kHz				INSERT
LEVEL	1.000 V				
DC BIAS	+0.000 V				DELETE
SPEED	MED.				
DELAY	0mS				
COMP MODE	VALUE				
NOM INAL					LIST RUN
UPPER	350.00uH				
LOWER	300.00uH				CORR.

Setting parameter

Steps

1. Press the **Measure** button to enter [MEAS DISPLAY] page, and then press the **LIST SET** function button on the right side of the LCD to enter the [LIST SET] page.



2. Use arrow keys to move cursor and select **PARAMETER** item on the [LIST SET] page.

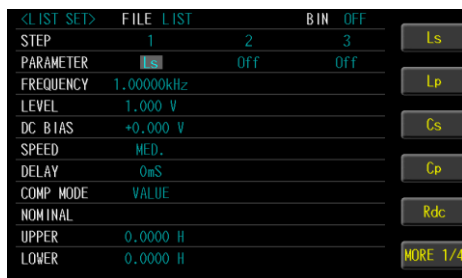

3. Use option key on the right of the LCD screen to select a parameter for this measurement item.

Parameter

Ls	Equivalent Series Inductance
Lp	Equivalent Parallel Inductance
Cs	Equivalent Series Capacitance
Cp	Equivalent Parallel Capacitance
Rdc	DC Resistance
Rs	Equivalent Series Resistance (ESR)
Rp	Equivalent Parallel Resistance
Z	Absolute value of impedance
θ_{deg}	Phase angle of impedance(degree)

θ_{rad}	Phase angle of impedance(radian)
Q	Quality Factor, (Q = 1/D)
D	Dissipation Factor, Loss coefficient ($\tan\delta$)
R	Resistance
X	Reactance
Y	Absolute value of admittance
G	Conductivity
B	Susceptance

Setting frequency

The frequency range is 10Hz~1MHz/5MHz/10MHz/20MHz/30/50MHz, and the resolution is set at 6 digits..

Steps

1. Press the **Measure** button to enter [MEAS DISPLAY] page, and then press the **LIST SET** function button on the right side of the LCD to enter the [LIST SET] page.



2. Use arrow keys to move cursor and select **FREQUENCY** item on the [LIST SET] page.



<LIST SET>	FILE LIST	BIN	OFF
STEP	1	2	3
PARAMETER	LS	Off	Off
FREQUENCY	1.00000kHz		
LEVEL	1.000 V		
DC BIAS	+0.000 V		
SPEED	MED.		
DELAY	0ms		
COMP. MODE	VALUE		
NOMINAL			LIST RUN
UPPER	0.0000 H		
LOWER	0.0000 H		CORR.

3. Use the numeric keypad to enter the test frequency.

Setting level

Test signal voltage/current level can be set (RMS value). The voltage range is 10mV-2Vrms and current range is 0.1mA-20mA_{rms}. 2Vrms can only be used at <= 1MHz..

Steps

1. Press the **Measure** button to enter [MEAS DISPLAY] page, and then press the **LIST SET** function button on the right side of the LCD to enter the [LIST SET] page.



2. Use arrow keys to move cursor and select **LEVEL** item on the [LIST SET] page.

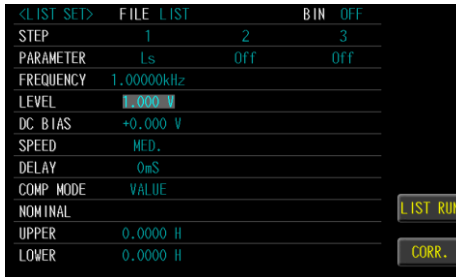

3. Use the numeric keypad to enter the test voltage/current.

Setting DC bias

DC BIAS range is -12V~+12V. When input is above the instrument voltage range will be displayed “Out of range!”. The test step has DC BIAS. When this step is tested, the instrument will automatically execute the DC BIAS output, and the DC Bias button will light up and will automatically turn off at the end of the step.

Steps

1. Press the **Measure** button to enter [MEAS DISPLAY] page, and then press the **LIST SET** function button on the right side of the LCD to enter the [LIST SET] page.



2. Use arrow keys to move cursor and select **DC BIAS** item on the [LIST SET] page.

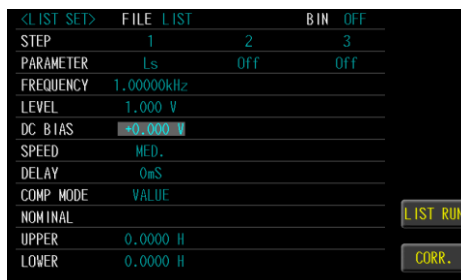

3. Use the numeric keypad to enter the test DC Bias.

Setting speed

5 test speeds (SLOW2, SLOW, MED., FAST and MAX.). The slower the test, the more accurate and stable the test result.

Steps

1. Press the **Measure** button to enter [MEAS DISPLAY] page, and then press the **LIST SET** function button on the right side of the LCD to enter the [LIST SET] page.



2. Use arrow keys to move cursor and select **SPEED** item on the [LIST SET] page.

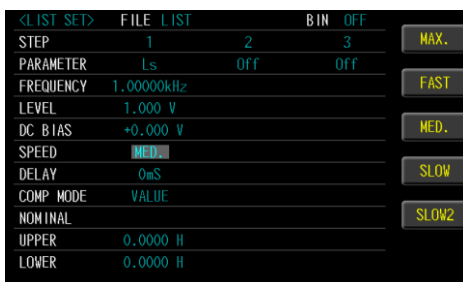

3. Use option key on the right of the LCD screen to select a test speed item.

Available test speed

MAX. 2.5ms(>10kHz)

FAST 50ms(>20Hz)

MED. 100ms

SLOW 300ms

SLOW2 600ms

Setting delay

Set the delay time before each test step. The delay time range is 0ms~5000ms.

Steps

1. Press the **Measure** button to enter [MEAS DISPLAY] page, and then press the **LIST SET** function button on the right side of the LCD to enter the [LIST SET] page.



2. Use arrow keys to move cursor and select **DELAY** item on the [LIST SET] page.



<LIST SET>	FILE	LIST	BIN	OFF
STEP	1	2	3	
PARAMETER	1s	Off	Off	
FREQUENCY	1.00000kHz			
LEVEL	1.000 V			
DC BIAS	+0.000 V			
SPEED	MED.			
DELAY	0ms			
COMP. MODE	VALUE			
NOMINAL				LIST RUN
UPPER	0.0000 H			
LOWER	0.0000 H			CORR.

3. Use the numeric keypad to enter the delay time.

Setting comp mode

The comparison function settings of 1 to 15 steps can be performed separately. The comparison mode has measured values, tolerance values and tolerance %.

Steps

1. Press the **Measure** button to enter [MEAS DISPLAY] page, and then press the **LIST SET** function button on the right side of the LCD to enter the [LIST SET] page.



2. Use arrow keys to move cursor and select **COMP MODE** item on the [LIST SET] page.



< LIST SET >	FILE	LIST	BIN	OFF	
STEP	1	2	3		VALUE
PARAMETER	1s	OFF	OFF		
FREQUENCY	1.0000kHz				Δ
LEVEL	1.000 V				Δ%
DC BIAS	+0.000 V				OFF
SPEED	MED.				
DELAY	0mS				
COMP. MODE	VALUE				LIST RUN
NOMINAL					
UPPER	0.0000 H				
LOWER	0.0000 H				CORR.

3. Use option key on the right of the LCD screen to select a mode for this setup.

$\Delta\%$ The difference between the measured value and the NOMINAL value is compared with the percentage of the NOMINAL value.

Deviation percentages ($\Delta\%$) = Absolute value (Δ)/nominal value \times 100%

Select this mode, the NOMINAL value and UPPER and LOWER upper and lower limits must be set.

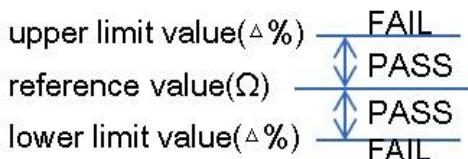

OFF Turn off the comparator function

Set up nominal/upper/lower

- Use arrow keys to move cursor and select **NOMINAL** or **UPPER** and **LOWER**.

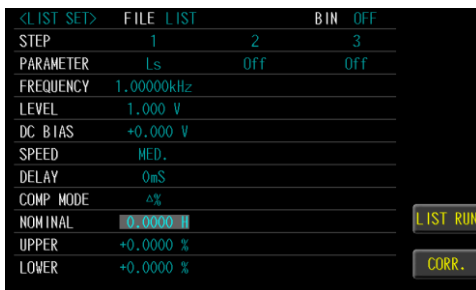

- Use key pad to input value and unit.

Available options

NOMINAL Compare nominal values. Set only in the Δ and $\Delta\%$ modes.

UPPER Comparison of upper limit

LOWER Comparison of lower limit

Comparator
result display

- Press the **LIST RUN** function button on the right side of the LCD to enter [LIST RUN] page and press the **Trigger** button to run test. Comparator result is Pass in green color or Fail in red color.

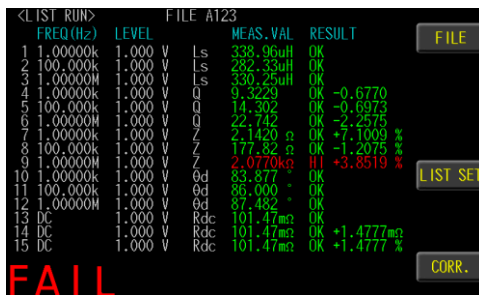

Setting trigger mode

List test step offers REPEAT and SINGLE and AUTO mode.

When the part is tested manually, it is traditionally necessary to connect the object to be tested, and then press the TRIGGER button or use the foot switch to start the measurement. Sometimes the measurement result is wrong because it is not matched, which is time-consuming and labor-intensive. Switch to AUTO mode and use automatic trigger to measure, save time and accuracy.

Steps

1. Press the **Measure** button to enter [MEAS DISPLAY] page, and press the **LIST SET** function button on the right side of the LCD to enter the [LIST SET] page, and then press the **Setup** button to enter [LIST MODE SETUP] page.



2. Use arrow keys to move cursor and select **TRIGGER MODE** item on the [LIST MODE SETUP] page.



LIST SET	FILE LIST	BIN	OFF	
STEP	LIST MODE SETUP	3		REPEAT
PARAM	TRIGGER MODE	SINGLE	1s	
FREQUE	TRIGGER DELAY	0mS	000MHz	SINGLE
LEVEL	AUTO TRIG THRESHOLD		0.0 V	
DC BIA	OUTPUT IMPEDANCE	100Ω	0.00 V	AUTO
SPEED	ALC	OFF	1.0	
DELAY	BEEP WHEN	OFF	0mS	
COMP M	RANGE HOLD	OFF	0%	
NOMINA	FAIL RETEST	OFF	0.00mH	PRESET
UPPER	STATISTICS	OFF	0.00 %	
LOWER	-10.000 %	-10.000 %	-10.000 %	EXIT

3. Use option key on the right of the LCD screen to select a desired item.

Available parameter	REPEAT	<p>The repeat trigger mode is an internal continuous test. After the LIST RUN display is shown, all processes will remain testing with arrow sign indicating the current test position. Pressing the STOP key beside LCD will suspend test. Pressing the Trigger key will resume continuous test.</p>
	SINGLE	<p>External trigger mode, including Manual/Handler/TRIGGER Input/Remote control mode.</p> <ul style="list-style-type: none">• Manual mode: The device performs a measurement once the Trigger button is pressed.• Handler mode: When a negative edge pulse is received from the handler interface on the rear panel, the device performs a measurement cycle.• TRIGGER Input mode: When a negative edge pulse is received from the TRIGGER Input on the rear panel, the device performs a measurement cycle.• Remote control mode: When a measurement command is sent from the RS-232 or USB or GPIB interface, the device performs a measurement cycle.
	AUTO	<p>Automatic trigger mode. After the measurement terminal is open, it will enter the standby mode "Wait On" Wait On, the instrument will always measure, after measuring the value, it will start the trigger condition for measurement, and after</p>

the LIST step test, it will enter the waiting for end mode "Wait Off" **Wait Off**.

Trigger condition: AC Im \geq AUTO TRIG THRESHOLD set value.

Reduce the waiting trigger time, with FAIL RETEST setting, suitable for manual testing.

The mode status is displayed in the middle of the LCD.

Setting trigger delay

Set the trigger delay time before each list test. The delay time range is 0ms~5000ms.

Steps

1. Press the **Measure** button to enter [MEAS DISPLAY] page, and press the **LIST SET** function button on the right side of the LCD to enter the [LIST SET] page, and then press the **Setup** button to enter [LIST MODE SETUP] page.
2. Use arrow keys to move cursor and select **TRIGGER DELAY** item on the [LIST MODE SETUP] page.

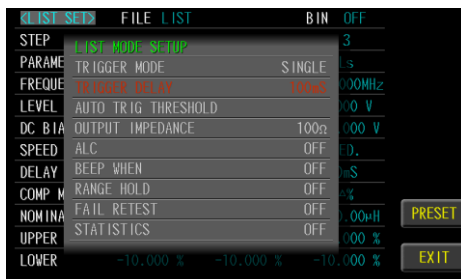

3. Use the numeric keypad to enter the delay time.

Setting AUTO TRIG THRESHOLD

Auto trigger threshold value, with default in 10 μ A, is basically triggered by AC measured current. The AC measured current, which is measured by DUT in the 1st step of LIST SET, is supposed to be greater than or equal to the auto trigger threshold value so that the LIST RUN measurement will be activated by auto trigger threshold. If auto trigger measurement couldn't be activated, go to MEAS DISPLAY to execute the condition setup and measurement of the 1st step in order to obtain AC measured current value followed by returning back to this item to define a proper value.

Take the following screenshot for example where AC Im is 6.1 μ A by which the default auto trigger threshold value 10 μ A couldn't be triggered automatically. Accordingly, it is required to define auto trigger threshold value as 5 μ A.

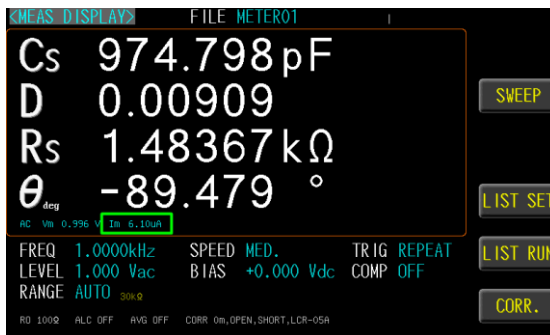

Available range is from 0.01 to 20000 with the unit of μ A. This item is only available when TRIGGER MODE is set in AUTO mode.

Steps

1. Press the **Measure** button to enter [MEAS DISPLAY] page, and press the **LIST SET** function button on the right side of the LCD to enter the [LIST SET] page, and then press the **Setup** button to enter [LIST MODE SETUP] page.



- Use arrow keys to move cursor and select **AUTO TRIG THRESHOLD** item on the [LIST MODE SETUP] page.

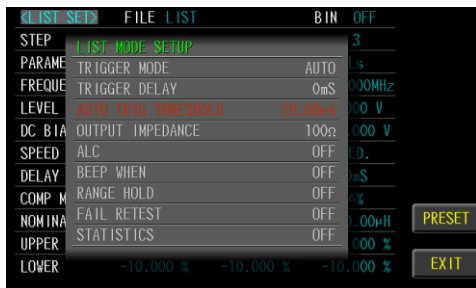

- Use the numeric keypad to enter the threshold value.

Setting OUTPUT IMPEDANCE

The output impedance can be set to 25Ω or 100Ω.

The varied signal source output impedance will lead to the varied current or the difference of measuring value. If selecting <25Ω>, then the voltage range is 10mV~1Vrms and the current range is 400μA~40mArms.

If need to compare test results with Keysight select 100Ω.

Steps

1. Press the **Measure** button to enter [MEAS DISPLAY] page, and press the **LIST SET** function button on the right side of the LCD to enter the [LIST SET] page, and then press the **Setup** button to enter [LIST MODE SETUP] page.
2. Use arrow keys to move cursor and select **OUTPUT IMPEDANCE** item on the [LIST MODE SETUP] page.



3. Use option key on the right of the LCD screen to select an impedance item.

Available parameter

- | | |
|------|---------------------------|
| 100Ω | Set output impedance 100Ω |
| 25Ω | Set output impedance 25Ω |

Setting ALC

The ALC (automatic level control) feature adjusts the voltage across the DUT or the current through the DUT to match the voltage/current level setting. Using this feature, you can try to ensure a constant signal level (voltage or current) is applied to the DUT.

In situations when the actual measuring Vac or Iac goes beyond the extent that the ALC can regulate, a warning message, “ALC

FAIL”  , will be shown at the bottom of the screen.

Steps

1. Press the **Measure** button to enter [MEAS DISPLAY] page, and press the **LIST SET** function button on the right side of the LCD to enter the [LIST SET] page, and then press the **Setup** button to enter [LIST MODE SETUP] page.
2. Use arrow keys to move cursor and select **ALC** item on the [LIST MODE SETUP] page.

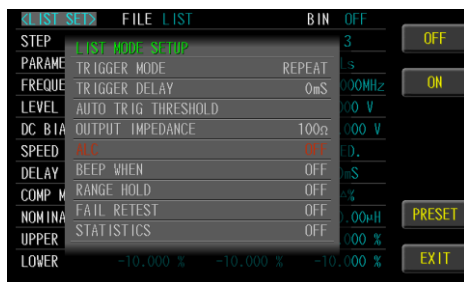

3. Use option key on the right of the LCD screen to select on or off.

Available parameter

OFF ALC function turn off

ON ALC function turn on

Setting beep when

When the comparison function setting is turned on, the value judgment result will be indicated by color, and the buzzer function can be set to use the sound to know the list test result.

Steps

1. Press the **Measure** button to enter [MEAS DISPLAY] page, and press the **LIST SET** function button on the right side of the LCD to enter the [LIST SET] page, and then press the **Setup** button to enter [LIST MODE SETUP] page.
2. Use arrow keys to move cursor and select **BEEP WHEN** item on the [LIST MODE SETUP] page.

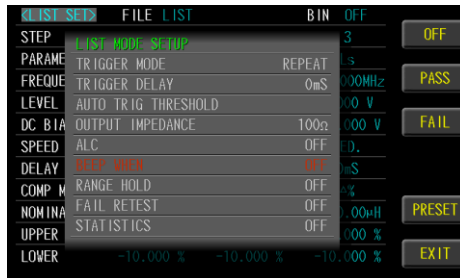

3. Use option key on the right of the LCD screen to select a desired item.

Available parameter

- OFF Turn off the beep function
- PASS Buzzer sounds when the list test pass
- FAIL Buzzer sounds when the list test fail

Setting range hold

When RANGE HOLD is set to OFF, the instrument will use the automatic range to measure to get the correct amount.

When RANGE HOLD is set to ON, use the correct part for the first measurement. The instrument will be fixed with the range used for the first measurement as the range position to be measured later, which can speed up the measurement.

When RANGE HOLD is set to OFF, the automatic range will be restored for measurement.

However, if the fixed range is incorrect, it will result in a wrong value.

Steps

1. Press the **Measure** button to enter [MEAS DISPLAY] page, and press the **LIST SET** function button on the right side of the LCD to enter the [LIST SET] page, and then press the **Setup** button to enter [LIST MODE SETUP] page.



2. Use arrow keys to move cursor and select **RANGE HOLD** item on the [LIST MODE SETUP] page.

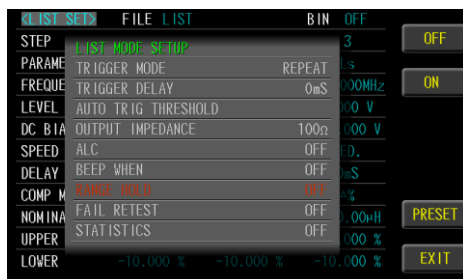

3. Use option key on the right of the LCD screen to select a desired item.

Available parameter	OFF	Use automatic range to measure
	ON	Use fixed range for measure

Setting fail reset

Using the AUTO mode for part testing saves time and accuracy, but sometimes the measurement results are wrong due to poor contact! You can use the FAIL RETEST function to re-measure when the contact is poor, so as to avoid the problem.

Steps

1. Press the **Measure** button to enter [MEAS DISPLAY] page, and press the **LIST SET** function button on the right side of the LCD to enter the [LIST SET] page, and then press the **Setup** button to enter [LIST MODE SETUP] page.



2. Use arrow keys to move cursor and select **FAIL RESET** item on the [LIST MODE SETUP] page.

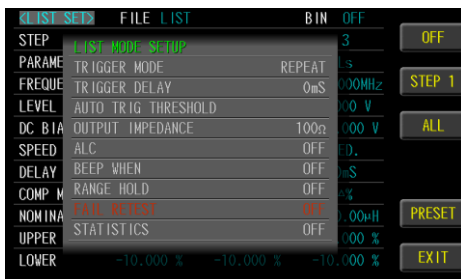

3. Use option key on the right of the LCD screen to select a desired item.

Available parameter	OFF	Fail retest function turn off
	STEP 1	Re-measure only when SETP 1 is bad
	ALL	Re-measurement every time a step is bad

Setting statistics

When the comparison function setting is on, the statistics function can be turned on to calculate the measurement quantity of PASS and FAIL.

Steps

1. Press the **Measure** button to enter [MEAS DISPLAY] page, and press the **LIST SET** function button on the right side of the LCD to enter the [LIST SET] page, and then press the **Setup** button to enter [LIST MODE SETUP] page.
2. Use arrow keys to move cursor and select **STSTISTICS** item on the [LIST MODE SETUP] page.

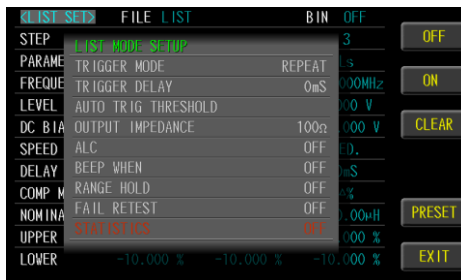

3. Use option key on the right of the LCD screen to select a desired item.

Available parameter

OFF	Turn off the statistics display
ON	Turn on the statistics display
CLEAR	Clear statistics quantity

Setting bin sorting

Choose to set the bin condition for each parameter, which can be divided into 2~9 classes. Bin methods include equalization, sequence, tolerance and random; limit value modes include measured values, tolerance values, and tolerance %.

Steps

1. Press the **Measure** button to enter [MEAS DISPLAY] page, and then press the **LIST SET** function button on the right side of the LCD to enter the [LIST SET] page.



2. Use arrow keys to move cursor and select **BIN** item on the [LIST SET] page.



<LIST SET>	FILE LIST	BIN OFF		
STEP	1	2	3	SET BIN
PARAMETER	1s	1s	1s	
FREQUENCY	1.0000kHz	10.000kHz	100.000kHz	
LEVEL	1.000 V	1.000 V	1.000 V	
DC BIAS	+0.000 V	+0.000 V	+0.000 V	
SPEED	MED.	MED.	MED.	
DELAY	0mS	0mS	0mS	
COMP MODE	△%	△%	△%	
NOMINAL	330.00μH	300.00μH	300.00μH	LIST RUN
UPPER	+10.000 %	+10.000 %	+10.000 %	
LOWER	-10.000 %	-10.000 %	-10.000 %	CORR.

3. Use option key on the right of the LCD screen to select **SET BIN** item.

Set up parameter 4. Use arrow keys to select **PARAMETER** item.

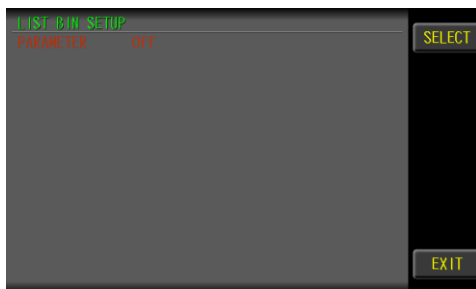

5. Use the **SELECT** option button on the right side of the LCD screen. Select the steps you want to perform the sorting.

Set up bin number

6. Use arrow keys to move cursor and select **BIN NUMBER** item.

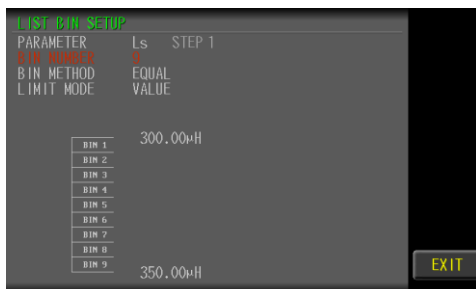

7. Use key pad to input bin number value.(2~9)

Set up bin method

- Use arrow keys to move cursor and select **BIN METHOD** item.

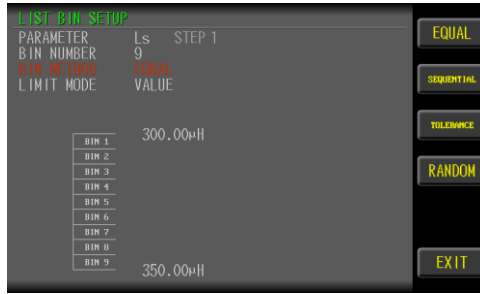

- Use option key on the right of the LCD screen to select a desired item.

Available options

Equal Sort by equally average. Set the high/low value.

Equal/ Sequential Mode

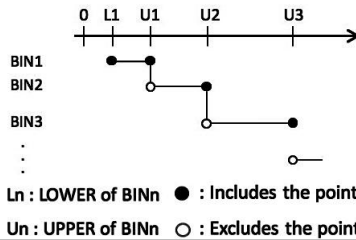

Sequential Sort by order. Set each value.

Tolerance Sort by order. Set each value.

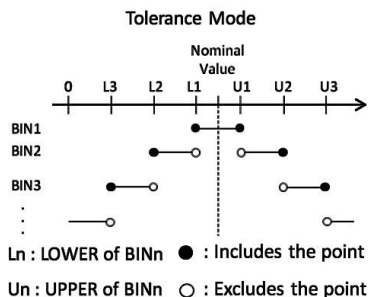

Random Sort by user. Set each range value.

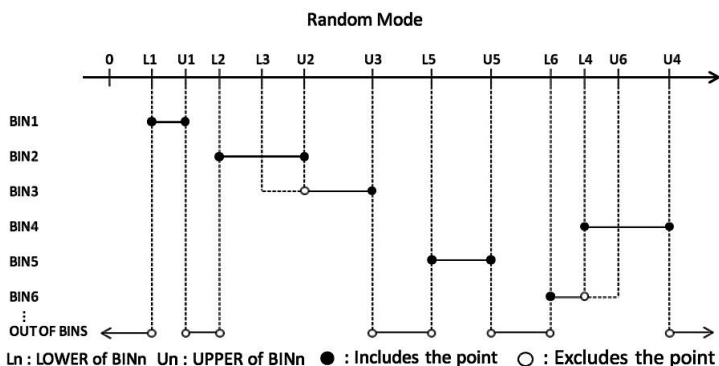

Set up limit mode

10. Use arrow keys to move cursor and select **LIMIT MODE**.

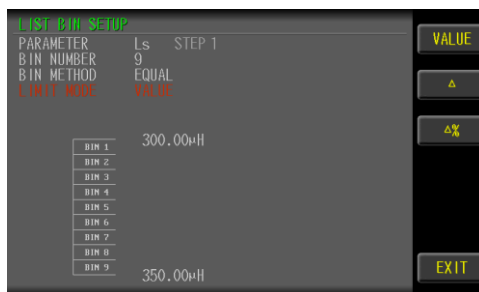

11. Use option key on the right of the LCD screen to select a desired item.

Available options

VALUE The measured values are compared.
 Select this mode, the NOMINAL field does not need to be set, just set the UPPER and LOWER upper and lower limits.

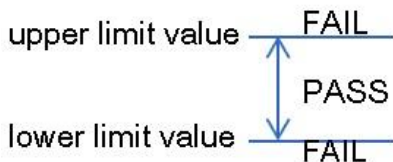

Δ The difference between the measured value and the NOMINAL value is compared.
 Absolute value (Δ) = measure value - nominal value
 Select this mode, the NOMINAL value and UPPER and LOWER upper and lower limits must be set.

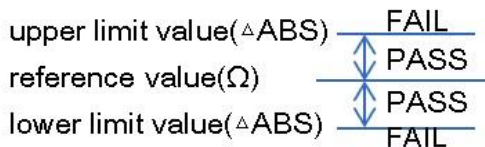

$\Delta\%$ The difference between the measured value and the NOMINAL value is compared with the percentage of the NOMINAL value.

Deviation percentages ($\Delta\%$) = Absolute value (Δ)/nominal value \times 100%

Select this mode, the NOMINAL value and UPPER and LOWER upper and lower limits must be set.

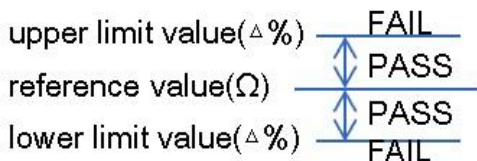

12. The LIST test BIN sort results below the LCD screen.

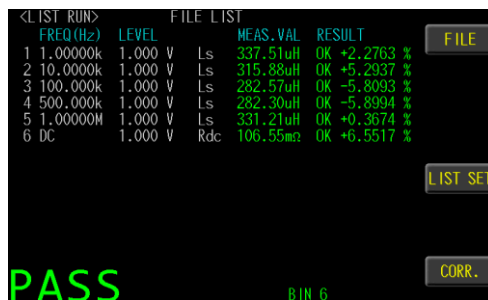

Setting FILE

The list setup can be saved in the flash Memory of the instrument.
The list mode allows the user to access 48 setup groups.

Steps

1. Press the **Measure** button to enter [MEAS DISPLAY] page, and then press the **LIST SET** function button on the right side of the LCD to enter the [LIST SET] page.



2. Use arrow keys to move cursor and select **FILE** item on the [LIST SET] page.



<LIST SET>	FILE	LIST	BIN	ON	FILE
STEP	4	5	6		
PARAMETER	Ls	Ls	Rdc		
FREQUENCY	500.000kHz	1.00000MHz			
LEVEL	1.000 V	1.000 V			
DC BIAS	+0.000 V	+0.000 V			
SPEED	MED.	MED.	MED.		
DELAY	0mS	0mS	0mS		
COMP. MODE	Δ%	Δ%	Δ%		
NOMINAL	300.00μH	330.00μH	100.00mΩ		LIST RUN
UPPER	+10.000 %	+10.000 %	+10.000 %		
LOWER	-10.000 %	-10.000 %	-10.000 %		CORR.

3. Use option key on the right of the LCD screen to select **FILE** item.

RAM FILE	FILES: 3	USB FILE
LIST	LIST-L	LIST01
		RECALL
		NEW
		COPY>USB
		DELETE
		EXIT

Available parameter	RECALL	load the files in the temporary files for testing
	NEW	Open an empty file and setting the file name
	SAVE AS	Save the test file in the RAM to another file.
	DELETE	Delete the file, the file which is being used (red) cannot delete.

**Note**

The LCR-8200 uses the system's temporary files for testing.

Use "RECALL" to load the files in the instrument memory into the temporary files of the system.

The file font being used is red and cannot be deleted. Any parameter change settings will be saved in the original file instantly.

USB disks can only back up test files. If you want to use this file, you need to copy the file to the instrument memory using "COPY> RAM" and then load it.

Setting USB disk

USB disk can store list setup files and LCD screen images.

Available types and file formats:

USB disk type: Flash disk only.

Format: FAT32 / exFAT.

Max memory size: 128GB.

Steps

1. Insert a USB disk for using as data recording. The instrument will automatically detect the USB disk format. When it is available, the USB menu will pop up.



2. Use option key on the right of the LCD screen to select a desired item. When the USB disk is plugged in, you can press the ENTER button to pop up the USB menu.



Available options

Save screen

Save LCD screen images to USB disk.

Path>

USB:\LCR8200\SCREEN\SCNxxxx.BMP



File management

USB file management.

Path> USB:\LCR8200\LIST

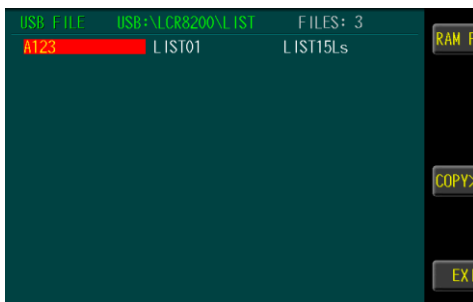

Format USB drive

Format the USB disk(FAT32)



CORRECTION

(OPEN/SHORT)

In this chapter you will learn about all the correction settings.

Correction process	126
Setting open	128
Setting short	130
Setting HF load	132
Setting spot load	134
Setting cable length	136
Setting fixture compensation	137
Setting spot no.	138
Setting frequency	139
Setting load function	140
Setting reference	142
Measure load	143

Correction process

Prior to each measurement, the user needs to correct the fixture or test cable to eliminate stray capacitance and series impedance that may be generated by the fixture or test cable. Application when using LCR-8200 or changing a fixture in a new environment. Please check the test unit and the test fixture used for correct correction.

The same correction parameters are used for meter mode and sweep mode and list mode.

- | | |
|-------|--|
| Steps | <ol style="list-style-type: none">1. Go to the CORR. Correction page.2. Select the type of fixture used for FIXTURE COMPENSATION item.3. If the test fixture has a test cable or use an extension cable, set the CABLE LENGTH length selection. |
|-------|--|
-



Note

After setting **FIXTURE COMPENSATION**, **CABLE LENGTH** will not be set. If you want to set **CABLE LENGTH**, you must first set **FIXTURE COMPENSATION** to **OFF**.

4. Set the fixture to the open state, and then perform **OPEN** correction.
 5. Set the fixture to the short state, and then perform **SHORT** correction.
 6. Connect the **STD-LOAD** to the test fixture, and then perform **HF LOAD** correction.
-



The HF LOAD correction is not necessarily performed. Please refer to the test fixture using the operating manual and correct it according to the conditions.

7. Connect the STD-LOAD to the test fixture, and then perform **HF LOAD** correction.
-



The SPOT LOAD correction is not necessarily performed. Please refer to the correction status and determine whether to perform SPOT LOAD correction.



The test fixture correction includes OPEN, SHORT, HF LOAD, SPOT LOAD Four types correction processes to obtain compensation data, but not all of them need to be performed during correction.

Four types correction procedures can be independently turned off or turned on to compensate data for measurement.

For normal measurement, it is recommended to perform the OPEN correction and SHORT correction of the test fixture.



For the conditions and methods of test fixture correction, please refer to the instruction manual of the test fixture.

Setting open

For normal measurements, it is recommended that this item be executed. OPEN correction capability cancels errors due to the stray admittance in the test fixture.

Steps

1. Press the **Measure** button to enter [MEAS DISPLAY] page, and then press the **CORR.** function button on the right side of the LCD to enter the [CORRECTION] page.



2. Use arrow keys to move cursor and select **OPEN** item on the [CORRECTION] page.



3. Use option key on the right of the LCD screen to select **OPEN** item to start execution.
4. When the OPEN compensation is completed, the **OPEN** status will automatically switch to **ON**.



Note

The open correction is quite sensitive to noise - both noise originating externally and induced noise. Therefore, if open correction fails, you should check the following points before starting the correction process again:

- Check that the test fixture or the test cables are properly connected.
- Check that not any test piece is connected to the test fixture or the test cables.
- During the correction process, be sure not to disturb the fixture and the test cables or to move your hand near them.

Open Circuit



- If the H/L test pole of the test fixture can be adjusted, adjust the distance between the test poles to the distance when measuring.

Setting short

For normal measurements, it is recommended that this item be executed. The short correction compensates for any residual impedances, such as the impedance of the cables and the DUT connection points.

Steps

1. Press the **Measure** button to enter [MEAS DISPLAY] page, and then press the **CORR.** function button on the right side of the LCD to enter the [CORRECTION] page.



2. Use arrow keys to move cursor and select **SHORT** item on the [CORRECTION] page.



3. Use option key on the right of the LCD screen to select **SHORT** item to start execution.
4. When the SHORT compensation is completed, the **SHORT** status will automatically switch to **ON**.



If short correction fails, you should check the following points before starting the correction process again:

- Check that the test fixture or the test cables are properly connected.
- Check that the test fixture or the test cables are properly shorted together with the shorting bar.
- During the correction process, be sure not to disturb the fixture and the test cables or to move your hand near them.

Short Circuit
(short bar)



Setting HF load

This item does not necessarily need to be implemented. Some test fixtures have a standard LOAD, which can be performed with reference to the fixture instructions and requirements to perform LOAD (PHASE) compensation.

Steps

1. Press the **Measure** button to enter [MEAS DISPLAY] page, and then press the **CORR.** function button on the right side of the LCD to enter the [CORRECTION] page.



2. Use arrow keys to move cursor and select **HF LOAD** item on the [CORRECTION] page.



3. Use option key on the right of the LCD screen to select **HF LOAD** item to start execution.
4. When the LOAD compensation is completed, the **HF LOAD** status will automatically switch to **ON**.



Note

If HF load correction fails, you should check the following points before starting the correction process again:

- Check that the test fixture or the test cables are properly connected.
- Check that the test fixture or the test cables are properly shorted together with the STD-LOAD.
- During the correction process, be sure not to disturb the fixture and the test cables or to move your hand near them.

STD-LOAD
(LCR-05A, 100Ω)



Setting spot load

This item does not necessarily need to be implemented. If the OPEN/SHORT/LOAD compensation cannot make the measurement correct, you can perform SPOT LOAD compensation to let the instrument know the correct value through learning. Use the part with the known value as the standard value which will be recognized by the instrument during the test, the instrument will then shows this value in the test status.

Steps

1. Press the **Measure** button to enter [MEAS DISPLAY] page, and then press the **CORR.** function button on the right side of the LCD to enter the [CORRECTION] page.



2. Use arrow keys to move cursor and select **SPOT LOAD** item on the [CORRECTION] page.



3. Use option key on the right of the LCD screen to select OFF/ON item.
4. When set to ON, the setting items of the SPOT No. below will be turned enable.



If SPOT LOAD correction fails, you should check the following points before starting the correction process again:

- Check that the test fixture or the test cables are properly connected.
 - Check that the test fixture or the test cables are properly shorted together with the part.
 - During the correction process, be sure not to disturb the fixture and the test cables or to move your hand near them.
 - When it is under Sweep mode, the SPOT LOAD correction setting will not activate.
-

Setting cable length

When using a wired test fixture, set the length according to the line length to compensate when OPEN/SHOT correction.

Steps

1. Press the **Measure** button to enter [MEAS DISPLAY] page, and then press the **CORR.** function button on the right side of the LCD to enter the [CORRECTION] page.



2. Use arrow keys to move cursor and select **CABLE LENGTH** item on the [CORRECTION] page.

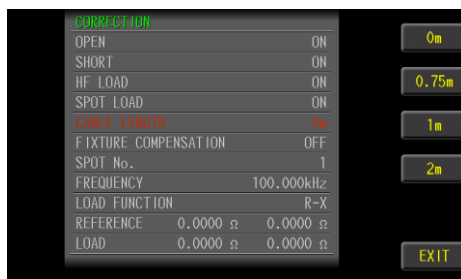

3. Use option key on the right of the LCD screen to select the line length item.



Note

If the **FIXTURE COMPENSATION** item is selected, **CABLE LENGTH** item will not be able to make selections.

Setting fixture compensation

If use a dedicated test fixture, select the corresponding option to do OPEN/SHORT/LOAD correction, which can increase the measurement accuracy.

Steps

1. Press the **Measure** button to enter [MEAS DISPLAY] page, and then press the **CORR.** function button on the right side of the LCD to enter the [CORRECTION] page.



2. Use arrow keys to move cursor and select **FIXTURE COMPENSATION** item on the [CORRECTION] page.

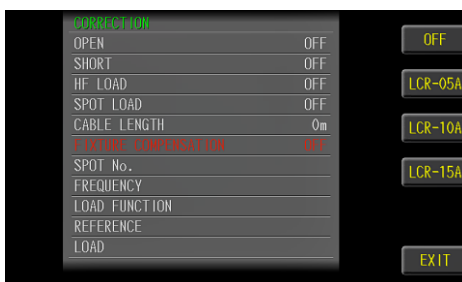

3. Use option key on the right of the LCD screen to select **FIXTURE** item.



Note

Only when it is used for test fixtures above 3MHz, it is necessary to set the fixture compensation.

Setting spot no.

The SPOT LOAD compensation point can be set to a maximum of 16 points. If the test frequency and measurement parameters are not the same, you need to increase the SPOT set point.

Steps

1. Press the **Measure** button to enter [MEAS DISPLAY] page, and then press the **CORR.** function button on the right side of the LCD to enter the [CORRECTION] page.



2. Use arrow keys to move cursor and select **SPOT No.** item on the [CORRECTION] page.



3. Use option key on the right of the LCD screen to select ↑or↓ item switch point number.

Setting frequency

Set whether each SPOT LOAD point is turned on. To use it, set the measurement frequency.

Steps

1. Press the **Measure** button to enter [MEAS DISPLAY] page, and then press the **CORR.** function button on the right side of the LCD to enter the [CORRECTION] page.



2. Use arrow keys to move cursor and select **FREQUENCY** item on the [CORRECTION] page.



3. Use option key on the right of the LCD screen to select **OFF** or **ON** item.
4. If select **ON**, Use the numeric keypad to enter the frequency value.



If the SPOT point is not used, be sure to turn off, otherwise it will affect the measurement results.

Setting load function

SPOT LOAD needs to set the real and imaginary values of the test part measurement parameters to obtain the correct phase angle and other calculation data.

Steps

1. Press the **Measure** button to enter [MEAS DISPLAY] page, and then press the **CORR.** function button on the right side of the LCD to enter the [CORRECTION] page.



2. Use arrow keys to move cursor and select **LOAD FUNCTION** item on the [CORRECTION] page.



3. Use option key on the right of the LCD screen to select ↑or↓ item switch function.



Note

Load function: <G-B>、<R-X>、<Cp-Rp>、<Cp-D>、<Cs-Rs>、<Cs-D>、<Lp-Rp>、<Lp-Q>、<Ls-Rs>、<Ls-Q>、<Y-Deg>、<Z-Deg>

$$Z = R + jX$$

Impedance is defined as, where the real part of impedance is the resistance R and the imaginary part is the reactance X

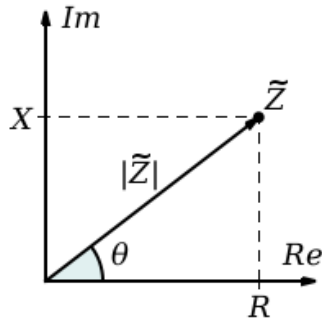

Setting reference

Enter the standard reference values for the real and imaginary parts of the part.

Steps

1. Press the **Measure** button to enter [MEAS DISPLAY] page, and then press the **CORR.** function button on the right side of the LCD to enter the [CORRECTION] page.



2. Use arrow keys to move cursor and select **REFERENCE** item on the [CORRECTION] page.

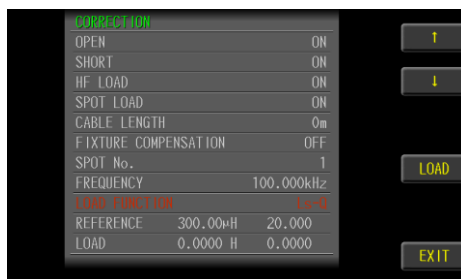

3. Use the numeric keypad to enter the real part (Ls) and imaginary part (Q) value.

Measure load

Place the load parts, and perform the part value measurement and display in the LOAD column.

Steps

1. Press the **Measure** button to enter [MEAS DISPLAY] page, and then press the **CORR.** function button on the right side of the LCD to enter the [CORRECTION] page.



2. Use arrow keys to move cursor and select **LOAD FUNCTION** item on the [CORRECTION] page.



3. Connect parts and test fixtures.
4. Use option key on the right of the LCD screen to select **LOAD** item for LOAD data metering.
5. The LOAD item displays the measured value.

S SYSTEM

CONFIGURATION

In this section, user will learn how to set the parameters on SYSTEM CONFIG page.

Setting GPIB address	145
Setting RS232 BAUD RATE.....	146
Setting RS232 EOI.....	147
Setting LAN PORT	148
Setting HANDLER INTERFACE	150
Setting KEY BEEP	151

Setting GPIB address

Set up the GPIB port address 1-30.

Steps

1. Press **System** button at the top right of the LCD screen to enter the [SYSTEM CONFIG] setting page.
2. Use up and down arrow keys to select **GPIB ADDRESS** on this setting page.

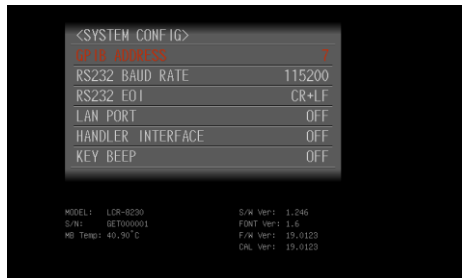

3. Use the numeric keypad to enter the address number.
-

Setting RS232 BAUD RATE

Set the RS-232 port baud rate. The USB port is the same baud rate used in VCP mode.

Steps

1. Press **System** button at the top right of the LCD screen to enter the [SYSTEM CONFIG] setting page.



2. Use up and down arrow keys to select **RS232 BAUD RATE** on this setting page.



3. Use option key on the right of the LCD screen to select a desired item.

Available parameter

9600	Baud rate is 9600bps
14400	Baud rate is 14400bps
19200	Baud rate is 19200bps
38400	Baud rate is 38400bps
57600	Baud rate is 57600bps
115200	Baud rate is 115200bps

Setting RS232 EOI

Set RS-232 command and return value the end of identify (EOI).

Steps

1. Press **System** button at the top right of the LCD screen to enter the [SYSTEM CONFIG] setting page.
2. Use up and down arrow keys to select **RS232 BAUD RATE** on this setting page.

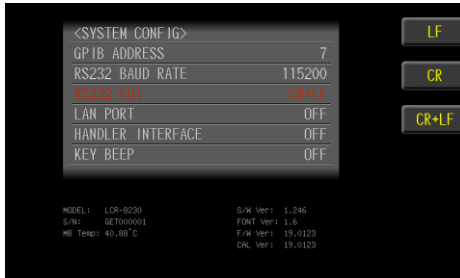
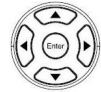

3. Use option key on the right of the LCD screen to select a desired item.

Available parameter

- | | |
|-------|-----------------|
| LF | EOI is LF(0x0A) |
| CR | EOI is CR(0x0D) |
| CR+LF | EOI is CR+LF |

Setting LAN PORT

Set LAN port setting.

Steps

1. Press **System** button at the top right of the LCD screen to enter the [SYSTEM CONFIG] setting page.



2. Use up and down arrow keys to select **LAN SETUP** on this setting page.

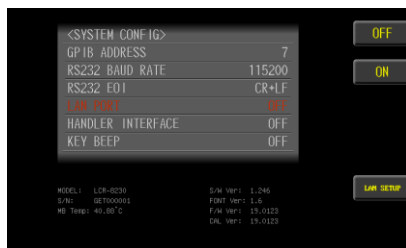

3. Use option key on the right of the LCD screen to select a desired item.

Available parameter

OFF	LAN port communication turn off
ON	LAN port communication turn on
LAN SETUP	LAN IP configures

LAN SETUP setting

4. Use option key on the right of the LCD screen to select a desired item.

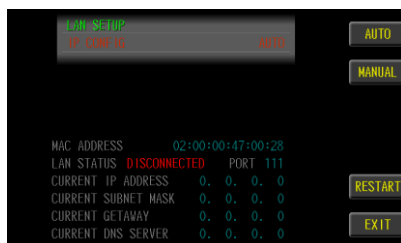

Available parameter	AUTO	Automatically obtains the IP address
	MANUAL	Manually configures the IP address
	RESTART	Reset the Ethernet card when new settings have been ready

AUTO setting

- The network line is inserted into the LAN port behind the machine, and the instrument reads the IP settings by automatically.

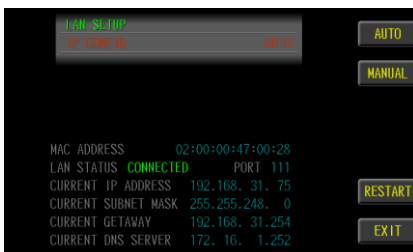

MANUAL setting

- Set up IP address, subnet mask, gateway, DNS server.

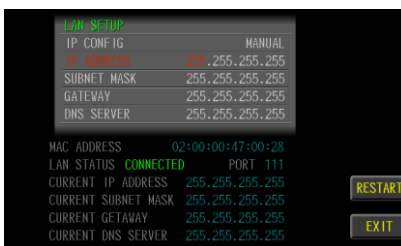

Setting HANDLER INTERFACE

Set the handle interface to open and close state. Requires Handler I/O output, need to enable setting. Without I/O output, the interface circuit can be closed, which can save measurement processing time about 1-2ms.

Steps

1. Press **System** button at the top right of the LCD screen to enter the [SYSTEM CONFIG] setting page.
2. Use up and down arrow keys to select **HANDLER INTERFACE** on this setting page.

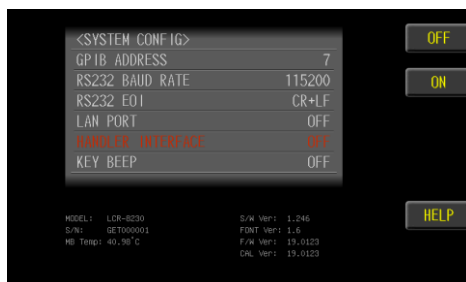

3. Use option key on the right of the LCD screen to select a desired item.

Available parameter

- | | |
|------|-----------------------------------|
| OFF | Handle interface to close |
| ON | Handle interface to open |
| HELP | Show handle interface pins define |

Setting KEY BEEP

Set the response sound when the keypad is operated

Steps

1. Press **System** button at the top right of the LCD screen to enter the [SYSTEM CONFIG] setting page.
2. Use up and down arrow keys to select **KEY BEEP** on this setting page.

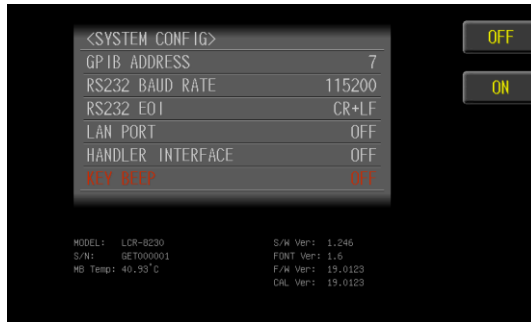

3. Use option key on the right of the LCD screen to select a desired item.

Available parameter	OFF	Turn off the beep sound
	ON	Turn on the beep sound

REMOTE CONTROL

This chapter describes basic configuration of remote control.

Handler Overview	153
Terminal type	153
Terminal diagrams	154
Universal terminal	155
Meter mode (BIN off) terminal	156
List mode (BIN off) terminal	156
Meter/List mode (BIN on) terminal	157
Electrical parameters	158
Timing Chart	161
Configure Interface	162
GPIB Interface	162
Configure GPIB Interface	163
LAN Interface	163
RS-232C Interface	164
Configure RS232 Interface	164
USB Interface	165
Configure USB Interface	165
Install USB Driver	167
External Trigger Input	169

Handler Overview

The device provides a full-featured handler interface that includes output signals of OK/NG and EOM, input signals of TRIG (activated by external trigger). Through this interface, the device can be easily controlled with the control components of user's system to complete automatic control functions.

Terminal type

Connector type female or DB25

Signal type Negative logic, Optocoupler-isolated, Open
collector output

Terminal

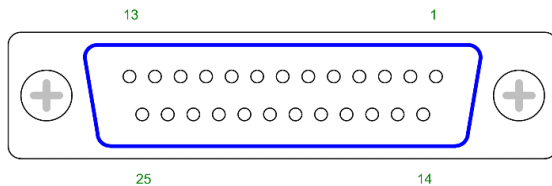

Terminal diagrams

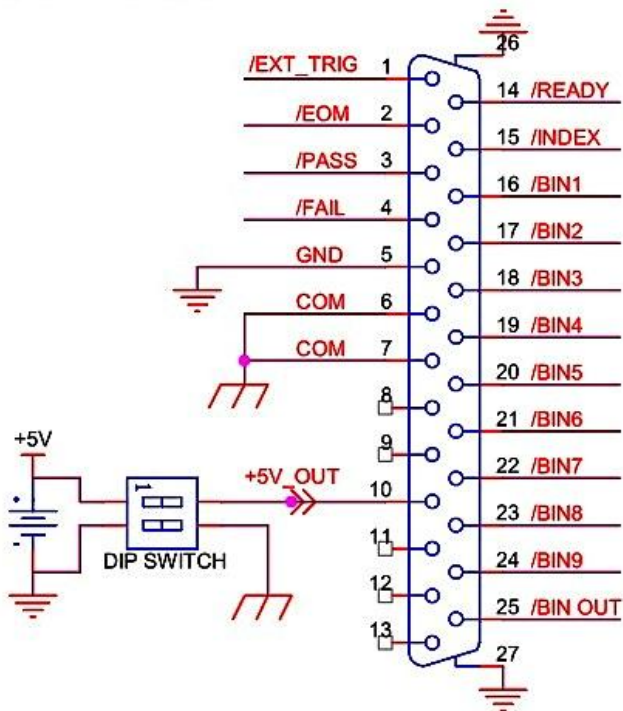

Universal terminal

Pin#	Name	Logic		Description
1	/EXT_TRIG	I	Negative, Edge	External trigger signal, pulse width $\geq 100\mu\text{s}$
2	/EOM	O	Negative, Level	"End of all measurement" signal
3	/PASS	O	Negative, Level	Pass signal of comparator
4	/FAIL	O	Negative, Level	Fail signal of comparator
5	Trig Return		Signal Return	External Trigger Signal Return
6	COM		Common ground	Common ground of result signal
7	COM		Common ground	Common ground of result signal
8	--		--	
9	--		--	
10	+5V out	O	DC_Power Out	+5V Supply, 100 mA max
11	--		--	
12	--		--	
14	/Ready	O	Negative, Level	"Ready for trigger" signal
15	/Index	O	Negative, Level	"End of analog measurement" signal

Meter mode (BIN off) terminal

Pin#	Name	Logic	Description
16	/PARA-1OK	O Negative, Level	Comparator result
17	/PARA-2OK	O Negative, Level	Comparator result
18	/PARA-3OK	O Negative, Level	Comparator result
19	/PARA-4OK	O Negative, Level	Comparator result
20	/PARA-1NG	O Negative, Level	Comparator result
21	/PARA-2NG	O Negative, Level	Comparator result
22	/PARA-3NG	O Negative, Level	Comparator result
23	/PARA-4NG	O Negative, Level	Comparator result
24	--	--	
25	--	--	

List mode (BIN off) terminal

Pin#	Name	Logic	Description
16	/STEP-1OK	O Negative, Level	Comparator result
17	/STEP-2OK	O Negative, Level	Comparator result
18	/STEP-3OK	O Negative, Level	Comparator result
19	/STEP-4OK	O Negative, Level	Comparator result
20	/STEP-1NG	O Negative,	Comparator result

			Level	
21	/STEP-2NG	O	Negative, Level	Comparator result
22	/STEP-3NG	O	Negative, Level	Comparator result
23	/STEP-4NG	O	Negative, Level	Comparator result
24	--		--	
25	--		--	

Meter/List mode (BIN on) terminal

Pin#	Name	Logic	Description
16	/BIN1	O	Negative, Level Bin judgment result
17	/BIN2	O	Negative, Level Bin judgment result
18	/BIN3	O	Negative, Level Bin judgment result
19	/BIN4	O	Negative, Level Bin judgment result
20	/BIN5	O	Negative, Level Bin judgment result
21	/BIN6	O	Negative, Level Bin judgment result
22	/BIN7	O	Negative, Level Bin judgment result
23	/BIN8	O	Negative, Level Bin judgment result
24	/BIN9	O	Negative, Level Bin judgment result
25	/BIN out	O	Negative, Level Out of BIN

Connection
method for
input circuit

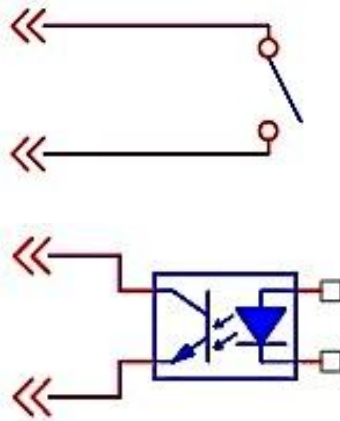

! Note

- Input signal: effective in Negative, Edge
- PIN1 (trigger) + PIN5 (gnd) Start testing after short circuit, the shorting time must be greater than 100uS.

Connection
method for
output circuit

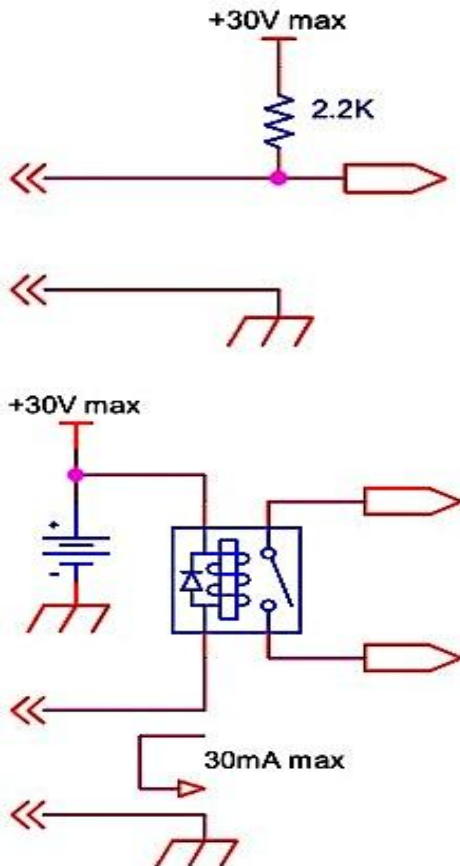

 Note

- Output signal: effective in Negative, Level
- Maximum voltage: 30VDC
- Maximum current: 30mA
- The other output pins are photo coupler circuit, output signal is low level. The output is as a high resistance floating circuit when it without action.



Note

- To avoid damaging the interface, the voltage of power supply voltage can't exceed the power requirements.
- To avoid damaging the interface, please connect cable after the device is powered off.

Timing Chart

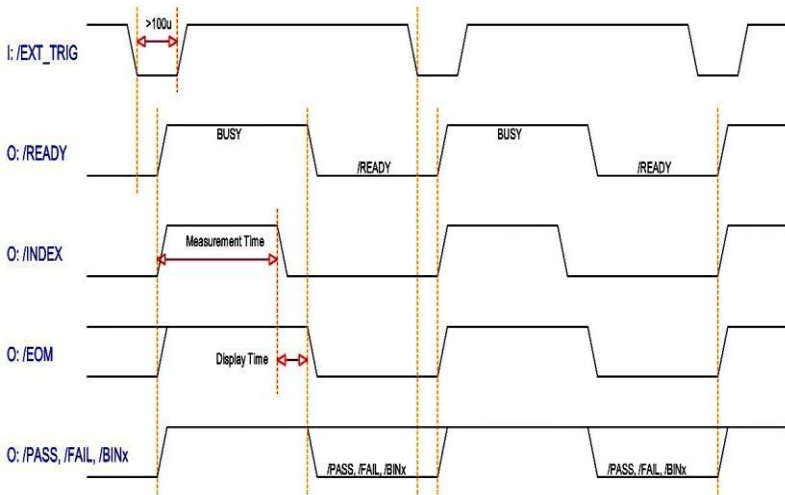

Configure Interface

Overview

The device uses the GPIB/ LAN/ RS-232/ USB interface to communicate with the computer to complete all devices' functions. With standard SCPI commands, users can easily create various acquisition systems which are suitable for themselves.

GPIB Interface

The computer and the measuring instrument are connected with GPIB (General-Purpose Interface Bus) cable, and the Test Piece will be tested or trimmed on the computer through GPIB.



Note

- At most, 15 units of equipment can be connected at the same time. The total length of connecting cable will be 20m, and the connecting cable between each the equipment is 2m long.
 - Each piece of equipment will be allocated with a specific position.
 - Min. 2/3 of equipment must be powered on.
 - The equipment will be connected by non-loop or parallel method
-

Configure GPIB Interface

24-pin block

GPIB Pin Assignments

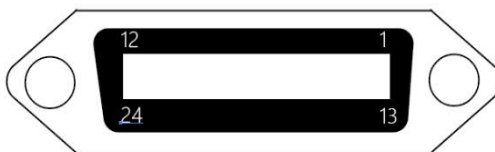

Pin	Definition	Pin	Definition
1	Dataline1	13	Dataline5
2	Dataline2	14	Dataline6
3	Dataline3	15	Dataline7
4	Dataline4	16	Dataline8
5	EOI	17	REN
6	DAV	18	Ground
7	NRFD	19	Ground
8	NDAC	20	Ground
9	IFC	21	Ground
10	SRQ	22	Ground
11	ATN	23	Ground
12	Shield	24	Signal ground

LAN Interface

10/100 Base T Ethernet, 8 pins

The instrument will be connected to the LAN (Local Area Network) ports.

RS-232C Interface

The RS-232 serial interface can be connected to the serial interface of a controller (PC or IPC) through a DB9 cable.



Note

- Use a GWINSTEK (null modem) DB-9 cable.
- Cable length should not exceed 2 meters.
- To avoid electrical shock, turn off the power when plugging and unplugging the DB-9 cable.

Configure RS232 Interface

Default transmission configuration	Transmission method	Full duplex asynchronous communication with start bit and stop bit
	Parity	None
	Hardware flow control	Off
	Data Bits	8
	Stop bit	1

RS232 Pin Assignments

Pin 2: RxD
 Pin 3: TxD
 Pin 5: GND
 Pin 1, 4, 6 - 9: No Connection

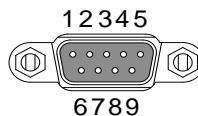

PC Connection Use a Null Modem connection as shown in the diagram below.

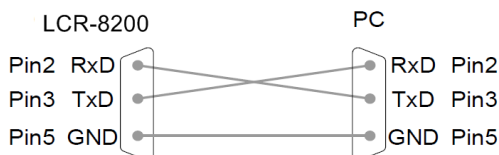

USB Interface

The device is equipped with built-in USB-232 interface which can directly virtualize the USB port as an RS232 port in the computer.

This virtual port can perform the same functions as RS232 and use the same settings as the RS232 port. It supports USB2.0 and below version.

The USB device port on the rear panel is used for remote control. The USB port is configured as CDC interface.

When configured to CDC, the USB port on the LCR-8200 series will appear as a virtual COM port to a connected PC. Any terminal program that can communicate via a serial port can be used for remote control. Before the LCR-8200 series can be used for remote control using the CDC USB class, if USB device driver hasn't been installed in PC, install the appropriate CDC USB driver included on the User Manual CD.

Configure USB Interface

Background	The Type B USB port on the rear panel is used for remote control. This interface creates a virtual COM port when connected to a PC.
------------	---



Note

The USB interface requires the USB driver to be installed. When LCR-8200 connects with PC, the USB driver will be installed automatically.

USB Configuration	PC connector	Type A, host
	LCR-8200 series connector	Rear panel Type B, slave connector
	Speed	1.1/2.0 (full speed/high speed)
	USB Class	CDC (Communications device class)
	Hardware flow control	Off

Data Bits	8
Stop bit	1

Install USB Driver

Background

The USB driver needs to be installed when using the USB port for remote control. The USB interface creates a virtual COM port when connected to a PC.

Install the USB driver

Install the USB VCP Driver (zadig-2.4.exe) from the CD.

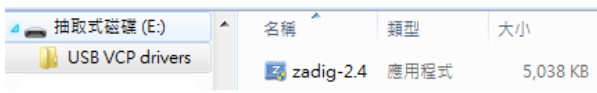

Execute the Zadig program.

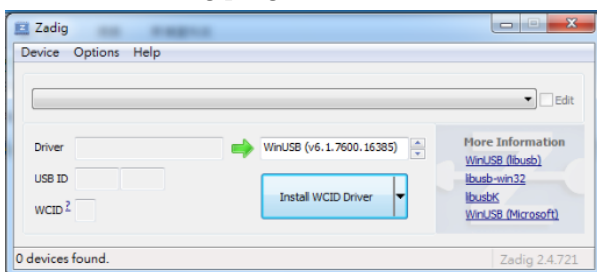

Connect the Type A-B USB cable to the rear panel USB B port on the LCR-8200Series. Connect the other end to the Type A port on the PC.



The Zadig software will detect the LCR-8200, select CDC, and press “Install Driver” to install the driver.

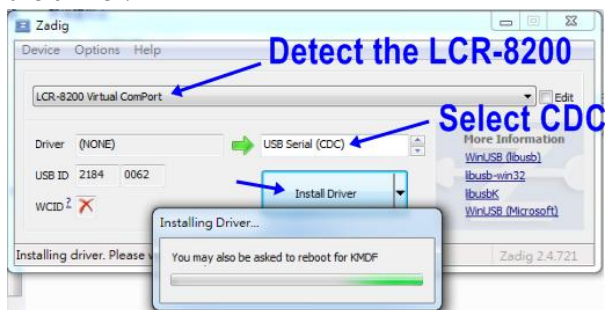

Successful installation.

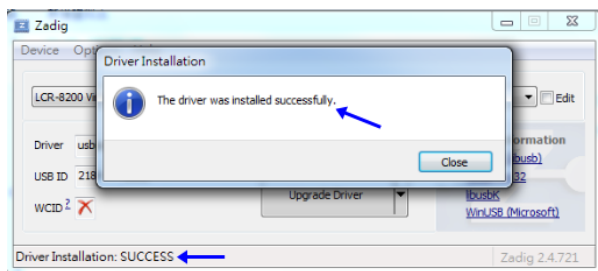

The LCR-8200 and the COM port that it is assigned to will now appear under the Ports (COM & LPT) node.





Note

- Please use the CD comes with the device to install. Click on the directory: USB VCP Drive
- To avoid electrical shock, turn off the power when plugging and unplugging the DB9 cable.
- If the driver installation is completed correctly, the number of USB serial port will be displayed.
- You need to remember this port number because you will use it when programming.

External Trigger Input

Trigger configuration	Level	TTL
	Pulse width	≤ 100 μs
	Polarity	Negative
	Connector type	Ø3.5 PHONE JACK

Circuit diagram

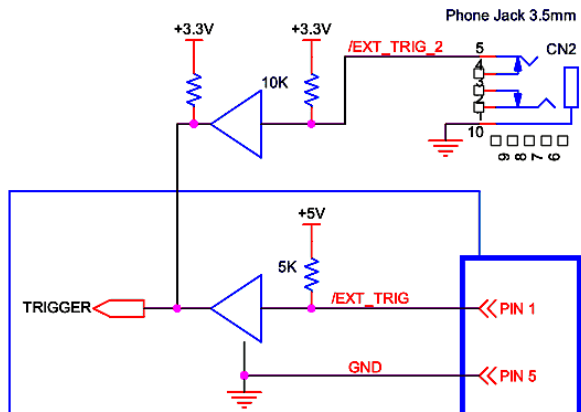

Connection method for input circuit



C COMMAND OVERVIEW

The Command overview chapter lists all programming commands in functional order as well as alphabetical order. The command syntax section shows you the basic syntax rules you have to apply when using commands.

Command Syntax.....	171
Command error code.....	174
Command List.....	176
Commands.....	177
MEASure Subsystem.....	192
LIST Subsystem.....	215
SWEep Subsystem.....	227

Command Syntax

Compatible Standard	IEEE488.2	Partial compatibility
	SCPI, 1994	Partial compatibility

Command Structure

SCPI (Standard Commands for Programmable Instruments) commands follow a tree-like structure, organized into nodes. Each level of the command tree is a node. Each keyword in a SCPI command represents each node in the command tree. Each keyword (node) of a SCPI command is separated by a colon (:). For example, the diagram below shows an SCPI sub-structure and a command example.

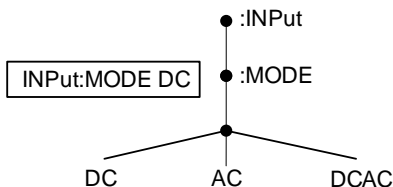

Command Types

There are a number of different instrument commands and queries. A command sends instructions or data to the unit and a query receives data or status information from the unit.

Command types

Simple A single command with/without a parameter

Example :INPut:MODE DC

Query A query is a simple or compound command followed by a question mark (?). A parameter (data) is returned.

Example :INPut:CFActor?

Command Forms Commands and queries have two different forms, long and short. The command syntax is written with the short form of the command in capitals and the remainder (long form) in lower case.

The commands can be written either in capitals or lower-case, just so long as the short or long forms are complete. An incomplete command will not be recognized.

Below are examples of correctly written commands.

Long form :INPut:SYNChronize VOLTage
:COMMunicate:HEADer ON

Short form :INP:SYNC VOLT
:COMM:HEAD ON

Square Brackets Commands that contain square brackets indicate that the contents are optional. The function of the command is the same with or without the square bracketed items, as shown below. For example, the query:

[:INPut]:FILTer?

Both :INPut:FILTer? and :FILTer? are valid forms.

Command Format

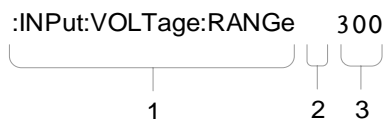

1. Command header
2. Space
3. Parameter 1

Common	Type	Description	Example
Input Parameters	<Boolean>	Boolean logic	0, 1
	<NR1>	integers	0, 1, 2, 3
	<NR2>	decimal numbers	0.1, 3.14, 8.5
	<NR3>	floating point with exponent	4.5e-1, 8.25e+1
	<NRf>	any of NR1, 2, 3	1, 1.5, 4.5e-1
	[MIN] (Optional parameter)	For commands, this will set the setting to the lowest value. This parameter can be used in place of any numerical parameter where indicated. For queries, it will return the lowest possible value allowed for the particular setting.	
[MAX] (Optional parameter)	For commands, this will set the setting to the highest value. This parameter can be used in place of any numerical parameter where indicated. For queries, it will return the highest possible value allowed for the particular setting.		
Message Terminator (EOL)	Remote Command	Marks the end of a command line. The following messages are in accordance with IEEE488.2 standard. CR+LF The most common EOL character is CR+LF	
Message Separator	EOL or ; (semicolon)	Command Separator	

Common Commands

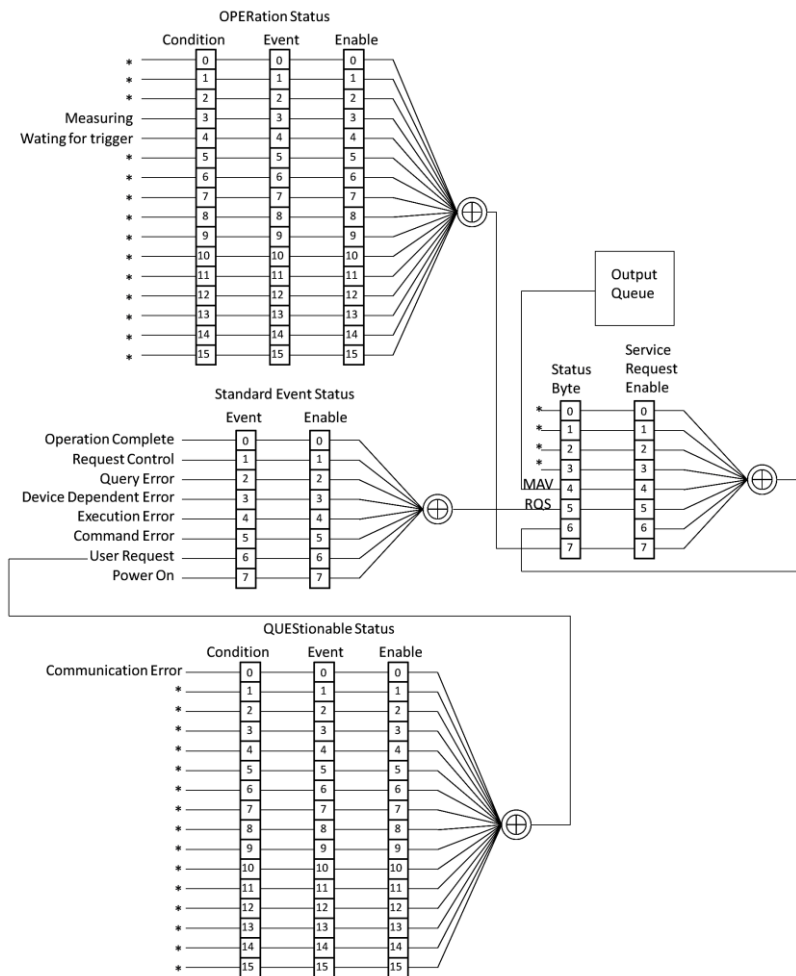

Command error code

-100 // Command error
-102 // Syntax error
-108 // Parameter not allow (Too much parameters)
-109 // Missing parameter
-113 // Undefined header (query a command only command or query
command missing '?')
-121 // Invalid character in number
-128 // Numeric data not allowed
-131 // Invalid suffix
-211 // Trigger ignored
-220 // Parameter error
-222 // Data out of range
-224 // Illegal parameter
-230 // Data corrupt or stale
-256 // File not found
-340 // Calibration failed
-350 // Queue overflow
-363 // Input buffer overrun
-410 // Query interrupted
-420 // Query unterminate

Command List

Command

:STATus:OPERation:CONDition?	185
:STATus:OPERation:EVENT?	185
:STATus:OPERation:ENABLE <NR1>	185
:STATus:OPERation:ENABLE?	185
:STATus:QUESTionable:CONDition?	185
:STATus:QUESTionable:EVENT?	186
:STATus:QUESTionable:ENABLE <NR1>	186
:STATus:QUESTionable:ENABLE?	186
*CLS	186
*ESE <NR1>	186
*ESE?	186
*ESR?	187
*IDN?	187
*OPC	187
*OPC?	187
*OPT?	188
*RST	188
*SRE <NR1>	188
*SRE?	188
*STB?	189
*WAI	189
*TST?	189
*TRG	189
*TRG?	189
:TRIGger	189
:TRIGger?	189
:DISPlay:PAGE{MEASure SWEep CORRection LSET LRUN SYSTem}	190
:DISPlay:PAGE?	190
:SYST:ERR?	190
:SYST:VERSion?	191
:SYST:SER?	191

Measure Subsystem

:MEASure:PARAMeter	
{OFF RDC LS LP CS CP Q D RS RP Z DEG RAD R X Y G B}	192
:MEASure:PARAMeter?	192
:MEASure:FREQuency<frequency NR3/disc>	192
:MEASure:FREQuency?	192
:MEASure:SPEEd {MAXimum FAST MEDIum SLOW SLOW2 0 1 2 3 4}	193
:MEASure:SPEEd?	193
:MEASure:BEEPer {OFF PASS OK FAIL NG 0 1 2}	193
:MEASure:BEEPer?	193
:MEASure:VOLTage:AC <voltage NR3/disc>	193
:MEASure:VOLTage:AC?	193
:MEASure:VOLTage:DC <voltage NR3/disc>	194
:MEASure:VOLTage:DC?	194
:MEASure:CURRent:AC <current NR3/disc>	194
:MEASure:CURRent:AC?	194
:MEASure:CURRent:DC <current NR3/disc>	195
:MEASure:CURRent:DC?	195
:MEASure:ALC {OFF ON 0 1}	195
:MEASure:ALC?	195
:MEASure:SMONitor {0 1 OFF ON}	196
:MEASure:SMONitor?	196
:FETCH:SMONitor:DC?	196
:FETCH:SMONitor:AC?	196
:MEASure:AVERage <average NR1>	196
:MEASure:AVERage?	196
:MEASure:TRIGger:DElay <delay time NR3/disc>	197
:MEASure:TRIGger:DElay?	197
:MEASure:DElay <delay time NR3/disc>	197
:MEASure:DElay?	197
:MEASure:TRIGger:MODE {REPeat 0 SINGle 1}	198
:MEASure:TRIGger:MODE?	198
:MEASure:RANGe:DC {1 2 3 4 AUTO HOLD}	198
:MEASure:RANGe:DC?	198
:MEASure:RANGe:AC {1 2 3 4 AUTO HOLD}	199
:MEASure:RANGe:AC?	199
:MEASure:OIMPedance {100 25}	199
:MEASure:OIMPedance?	199

:MEASure:COMParator:PARAMeter {1 2 3 4}	199
:MEASure:COMParator:PARAMeter?	199
:MEASure:COMParator:STATe {OFF ON 0 1}	200
:MEASure:COMParator:STATe?	200
:MEASure:COMParator:MODE <ABSolute DEViation PERCent 0 1 2> 200	
:MEASure:COMParator:MODE?	200
:MEASure:COMParator:NOMinal <nominal value NR3>	200
:MEASure:COMParator:NOMinal?	200
:MEASure:COMParator:UPPER <UPPER limit NR3>	201
:MEASure:COMParator:UPPER?	201
:MEASure:COMParator:LOWER <LOWER limit NR3>	201
:MEASure:COMParator:LOWER?	201
:MEASure:COMParator:DISPlay <ABSolute DEViation PERCent 0 1 2> 201	
:MEASure:COMParator:DISPlay?	201
:MEASure:BIN:PARAMeter	
{OFF RDC LS LP CS CP Q D RS RP Z DEG RAD R X Y G B}	202
:MEASure:BIN:PARAMeter?	202
:MEASure:BIN:NUMBer {2 3 4 5 6 7 8 9 MAXium MINimum}	202
:MEASure:BIN:NUMBer?	202
:MEASure:BIN:METHod	
{EQUal SEquential TOLerance RANDom 0 1 2 3}	202
:MEASure:BIN:METHod?	202
:MEASure:BIN:MODE <ABSolute DEViation PERCent 0 1 2>	203
:MEASure:BIN:MODE?	203
:MEASure:BIN:NOMinal <nominal value NR3 >	203
:MEASure:BIN:NOMinal?	203
:MEASure:BIN:LIMit <nominal value NR3 >	203
:MEASure:BIN:LIMit?	203
:MEASure:FILE:LOAD <filename>	204
:MEASure:FILE:LOAD?	204
:MEASure:FILE:NEW <filename>	204
:MEASure:FILE:SAVE <filename>	204
:MEASure:FILE:DELEte <filename>	204
:MEASure:FILE?	205
:MEASure:BIAS:VOLTage<NR2>	205
:MEASure:BIAS:VOLTage?	205
:MEASure:BIAS:STATe<ON OFF 0 1>	205
:MEASure:BIAS:STATe?	205
:MEASure:STATistic {ON OFF 0 1}	205
:MEASure:STATistic?	205
:MEASure:STATistic:COUNT <pass count, fail count>	206

:MEASure:STATistic:COUNT?	206
:FETCh?	206
:FETCh:SMONitor:DC?	208
:FETCh:SMONitor:AC?	208
:FETCh:MODE {0 1 QUERy AUTO}	208
:FETCh:MODE?	208
:CORRection:OPEN	209
:CORRection:OPEN?	209
:CORRection:SHORT	209
:CORRection:SHORT?	209
:CORRection:OPEN:STATe {OFF ON 0 1}	210
:CORRection:OPEN:STATe?	210
:CORRection:SHORT:STATe {OFF ON 0 1}	210
:CORRection:SHORT:STATe?	210
:CORRection:CABLe {0 0.75 1 2}	210
:CORRection:CABLe?	210
:CORRection:HF	210
:CORRection:HF?	210
:CORRection:HF:STATe {ON OFF 0 1}	211
:CORRection:HF:STATe?	211
:CORRection:LOAD	211
:CORRection:LOAD?	211
:CORRection:LOAD:STATe {ON OFF 0 1}	212
:CORRection:LOAD:STATe?	212
:CORRection:FIXTure {OFF LCR-05A LCR-10A LCR-15A}	212
:CORRection:FIXTure?	212
:CORRection:LOAD:SPOT <spot number 1-16>	212
:CORRection:LOAD:SPOT?	212
:CORRection:LOAD:FREQuency <frequency in NR3>	213
:CORRection:LOAD:FREQuency?	213
:CORRection:LOAD:FUNction {LS-Q LS-RS LP-Q LP-RP CS-D CS-RS CP-D CP-RP R-X G-B Z-DEG Y-DEG}	213
:CORRection:LOAD:FUNction?	213
:CORRection:LOAD:REFerence <reference A,reference B>	214
:CORRection:LOAD:REFerence?	214
:CORRection:LOAD:VALue <load A,load B>	214
:CORRection:LOAD:VALue?	214

List Subsystem

:LIST:STEP{1 2 3 4 ... 14 15}	215
:LIST:STEP?	215
:LIST:PARAMeter	
{OFF RDC LS LP CS CP Q D RS RP Z DEG RAD R X Y G B}	215
:LIST:PARAMeter?	215
:LIST:FREQUency <frequencyNR3/disc>	215
:LIST:FREQUency?	215
:LIST:VOLTAge<voltage NR3/disc >	216
:LIST:VOLTAge?	216
:LIST:CURREnt <current NR3/disc >	216
:LIST:CURREnt?	216
:LIST:SPEEd {MAXimum FAST MEDIum SLOW SLOW2 0 1 2 3 4} ...	217
:LIST:SPEEd?	217
:LIST:DELAy <delay time NR3/disc>	217
:LIST:DELAy?	217
:LIST:COMPARator:MODE <ABSolute DEVIation PERCent OFF 0 1 2>	218
:LIST:COMPARator:MODE?	218
:LIST:COMPARator:NOMinal <nominal value NR3 >	218
:LIST:COMPARator:NOMinal?	218
:LIST:COMPARator:UPPER <upper limit NR3>	218
:LIST:COMPARator:UPPER?	218
:LIST:COMPARator:LOWER <LOWER limit NR3>	219
:LIST:COMPARator:LOWER?	219
:LIST:BIN:STEP {1 2 3 4 ... 14 15}	219
:LIST:BIN:STEP?	219
:LIST:BIN:PARAMeter	
{OFF RDC LS LP CS CP Q D RS RP Z DEG RAD R X Y G B}	219
:LIST:BIN:PARAMeter?	219
:LIST:BIN:NUMBer {2 3 4 5 6 7 8 9 MAXium MINimum}	220
:LIST:BIN:NUMBer?	220
:LIST:BIN:METHod {EQUal SEQUential TOLerance RANDom 0 1 2 3}	220
:LIST:BIN:METHod?	220
:LIST:BIN:MODE <ABSolute DEVIation PERCent 0 1 2>	220
:LIST:BIN:MODE?	220
:LIST:BIN:NOMinal <nominal value NR3 >	221
:LIST:BIN:NOMinal?	221
:LIST:BIN:LIMit <nominal value NR3 >	221

:LIST:BIN:LIMit?	221
:LIST:TRIGger:MODE {REPeat SINGle AUTO}	221
:LIST:TRIGger:MODE?	221
:LIST:TRIGger:DELaY <delay time NR3/disc>	222
:LIST:TRIGger:DELaY?	222
:LIST:OIMPedance {100 25}	222
:LIST:OIMPedance?	222
:LIST:ALC {OFF ON 0 1}	222
:LIST:ALC?	222
:LIST:BEEPer {OFF PASS OK FAIL NG 0 1 2}	223
:LIST:BEEPer?	223
:LIST:RANGe {AUTO HOLD 0 1}	223
:LIST:RANGe?	223
:LIST:RETest {OFF STEP ALL 0 1 2}	223
:LIST:RETest?	223
:LIST:FILE:LOAD <filename>	224
:LIST:FILE:LOAD?	224
:LIST:FILE:NEW <filename>	224
:LIST:FILE:SAVE <filename>	224
:LIST:FILE:DELEte <filename>	225
:LIST:FILE?	225
:LIST:BIAS:VOLTage <NR3>	225
:LIST:BIAS:VOLTage?	225
:LIST:STATistic {ON OFF 0 1}	226
:LIST:STATistic?	226
:LIST:STATistic:COUNT <pass count, fail count>	226
:LIST:STATistic:COUNT?	226

Sweep Subsystem

:SWEep:TYPE {FREQuency VAC IAC BIASV}	227
:SWEep:TYPE?	227
:SWEep:XAXis {LOGarithm LINear}	227
:SWEep:XAXis?	227
:SWEep:XAXis:DATA?	227
:SWEep:STARt <startNR3/disc>	228
:SWEep:STARt?	228
:SWEep:STOP <stopNR3/disc>	228
:SWEep:STOP?	228
:SWEep:FREQuency<frequencyNR3/disc>	229
:SWEep:FREQuency?	229
:SWEep:VOLTage <voltage NR3/disc>	229
:SWEep:VOLTage?	229
:SWEep:CURREnt<currentNR3/disc>	230
:SWEep:CURREnt?	230
:SWEep:TRIGger:MODE <REPeat SINGle 0 1>	231
:SWEep:TRIGger:MODE?	231
:SWEep:SPEEd {FAST MEDIum SLOW 1 2 3}	231
:SWEep:SPEEd?	231
:SWEep:TRACe {A B}	231
:SWEep:TRACe?	231
:SWEep:FUNCTion {LS LP CS CP Q D RS RP Z DEG RAD R X Y G B,OFF LS LP CS CP Q D RS RP Z DEG RAD R X Y G B }	232
:SWEep:FUNCTion?	232
:SWEep:DELay <delay timeNR3/disc>	232
:SWEep:DELay?	232
:SWEep:OIMPedance {100 25}	233
:SWEep:OIMPedance?	233
:SWEep:KEEP {OFF ON 0 1}	233
:SWEep:KEEP?	233
:SWEep:TRACA:PARAMeter {LS LP CS CP Q D RS RP Z DEG RAD R X Y G B }	233
:SWEep:TRACA:PARAMeter?	233
:SWEep:TRACA:YAXis {LOGarithm LINear}	233
:SWEep:TRACA:YAXis?	233

:SWEep:TRACA:REFeRence <value NR3>.....	234
:SWEep:TRACA:REFeRence?	234
:SWEep:TRACA:POSiTion {-10 ~ 16 MAXimun MINimum}	234
:SWEep:TRACA:POSiTion?	234
:SWEep:TRACA:DIViSion <value NR3/disc>	234
:SWEep:TRACA:DIViSion?	234
:SWEep:TRACA:DECade {1~12}.....	235
:SWEep:TRACA:DECade?	235
:SWEep:TRACA:MAXimum?.....	235
:SWEep:TRACA:MINimum?	235
:SWEep:TRACA:COLOr <1 2 3 4 5 6>	236
:SWEep:TRACA:COLOr?	236
:SWEep:TRACA:RESult?.....	236
:SWEep:TRACB:PARAMeter {LS LP CS CP Q D RS RP Z DEG RAD R X Y G B }	236
:SWEep:TRACA:PARAMeter?.....	236
:SWEep:TRACB:YAXis {LOGarithm LINear}	237
:SWEep:TRACB:YAXis?	237
:SWEep:TRACB:REFeRence <value NR3>.....	237
:SWEep:TRACB:REFeRence?	237
:SWEep:TRACB:POSiTion {-10 ~ 16 MAXimun MINimum}.....	237
:SWEep:TRACB:POSiTion?	237
:SWEep:TRACB:DIViSion <value NR3/disc>	238
:SWEep:TRACB:DIViSion?	238
:SWEep:TRACB:DECade {1~12}.....	238
:SWEep:TRACB:DECade?	238
:SWEep:TRACB:MAXimum?.....	238
:SWEep:TRACB:MINimum?	239
:SWEep:TRACB:COLOr <1 2 3 4 5 6>	239
:SWEep:TRACB:COLOr?	239
:SWEep:TRACB:RESult?	239
:SWEep:AUToscale	239
:SWEep:RESult?	240
:SWEep:BIAS:VOLTage<NR3>	240
:SWEep:BIAS:VOLTage?	240
:SWEep:ANALysis:MODEl {A B C D E F G OFF}.....	240
:SWEep:ANALysis:MODEl?	240
:SWEep:ANALysis:TRACA:COLOr <0 1 2 3 4 5 6 7 8 9 10 11 12>	240
:SWEep:ANALysis:TRACA:COLOr?	240
:SWEep:ANALysis:TRACB:COLOr <0 1 2 3 4 5 6 7 8 9 10 11 12>	241
:SWEep:ANALysis:TRACB:COLOr?	241

:SWEep:ANALysis:RESult?	241
:SWEep:ANALysis:CALCulate?	242
:SWEep:SRF:SERies?	242
:SWEep:SRF:PARAllel?	242

Commands

:STATus:OPERation:CONDition?

Function : It queries the status of Operation Status Register.

Description :

Query syntax: STATus:OPERation:CONDition?

Return data 0~65535 (Format is in <NR1>)

:STATus:OPERation:EVENT?

Function : It queries the status of Operation Event Register.

Description :

Query syntax: STATus:OPERation:EVENT?

Return data 0~65535 (Format is in <NR1>)

:STATus:OPERation:ENABLE <NR1>

:STATus:OPERation:ENABLE?

Function : It sets or queries the status of Operation Enable Register.

Description :

Set parameter 0~65535 <NR1>

Set syntax :STATus:OPERation:ENABLE 65535

Query syntax :STATus:OPERation:ENABLE?

Return data 65535 (Format is in <NR1>)

:STATus:QUESTionable:CONDition?

Function : It queries the status of Questionable Condition Register.

Description :

Query syntax: STATus:QUESTionable:CONDition?

Return data 0~65535 (Format is in <NR1>)

:STATus:QUEStionable:EVENT?

Function : It queries the status of Questionable Event Register.

Description :

Query syntax: STATus:QUEStionable:EVENT?

Return data 0~65535 (Format is in <NR1>)

:STATus:QUEStionable:ENABle <NR1>

:STATus:QUEStionable:ENABle?

Function : It sets or queries the status Questionable Enable Register.

Description :

Set parameter 0~65535 <NR1>

Set syntax :STATus:QUEStionable:ENABle 65535

Query syntax :STATus:QUEStionable:ENABle?

Return data 0~65535 (Format is in <NR1>)

*CLS

Function : It clears Error Queue, Standard Event Status Register,
Status Byte Register, and Operation Event Register.

*ESE <NR1>

*ESE?

Function : It sets or queries the status of Standard Event Status
Enable Register.

Description :

Set parameter 0~255

Set syntax *ESE 1

Query syntax *ESE?

Return data 0~255 (Format is in <NR1>)

***ESR?**

Function : It queries the status of Standard Event Status Register, clean the Register after executed.

Description :

Query syntax *ESR?

Return data <NR1>

***IDN?**

Function : It queries the identification of the instrument.

Description :

Query syntax *IDN?

Return data <field1>,<field2>,<field3>,<field4>

<field1>manufacturer

<field2>model number

<field3>serial number or 0

<field4>firmware revision

***LOC**

Function : When the instrument is in REMOTE (LOCK) mode, use this command to return the instrument to LOCAL (UNLOCK) mode. (Same as pressing the Key Lock key)

***OPC**

Function : Set the OPC bit of the ESR register.

***OPC?**

Function : When all commands are completed, 1 will be returned.

Description :

Query syntax *OPC?

Return data 1

***OPT?**

Function : It queries the hardware options installed in the instrument.

Description :

The maximum frequency of LCR-8201 is 1MHz, it returns F01
The maximum frequency of LCR-8205(A) is 5MHz, it returns F05
The maximum frequency of LCR-8210(A) is 10MHz, it returns F10
The maximum frequency of LCR-8220(A) is 20MHz, it returns F20
The maximum frequency of LCR-8230(A) is 30MHz, it returns F30
The maximum frequency of LCR-8250(A) is 50MHz, it returns F50

***RST**

Function : It aborts all pending operations, and sets LCR-8200 series to meter mode with initial setups.

Description :

Initial Setups
Parameters:Ls,Q,Z, θ deg
FREQuency:1kHz
LEVEL:1Vac
SPEED:MED.
TRIGger:REPEAT

SRE <NR1>**SRE?**

Function : It sets or queries the status of Service Request Enable Register.

Description :

Set parameter 0~255
Set syntax *SRE 1
Query syntax *SRE?
Return data 1 (Format is in <NR1>)

***STB?**

Function : It queries the Status Byte Register.

Description :

Query syntax *STB?

Return data <NR1>

***WAI**

Function : The command has no effect as commands are always processed sequentially.

***TST?**

Function : This instrument does not have self-test function. 0 is always returned.

Description :

Query syntax *TST?

Return data 0

TRG**TRG?****:TRIGger****:TRIGger?**

Function: It executes Trigger action. If using *TRG? or :TRIGger?, it executes Trigger action and returns test data.

Description :

Set syntax *TRG

Query syntax *TRG?

Return data -6.337855E-08,+3.980846E-06,+1.000338E+02,-
2.280857E-04,0

:DISPlay:PAGE{MEASure|SWEep|CORRection|LSET|LRUN|SYSTem}

:DISPlay:PAGE?

Function : It sets or queries the page currently displayed on the LCD screen.

Description :

Set parameter MEASure(meter mode), SWEep(sweep mode), CORRection(correction page),LSET(list mode), LRUN(list run), SYSTem(system page).

Set syntax :DISPlay:PAGE MEASure

:DISPlay:PAGE SWEep

Query syntax :DISPlay:PAGE?

Return data MEAS (Format is in <disc>)

:SYST:ERR?

Function : It queries the error number in error message queue over the interface. The instrument has an error queue which is 64 errors deep and operates on a first-in, first-out basis, Repeatedly sending the query ":SYSTem:ERRor?" returns the error numbers in the order that they occurred until the queue is empty. Any further queries then return zeros until another error occurs.

When the queue is empty, the ERR message on the LCD screen is removed at the same time.

Description :

Query syntax: SYST:ERR?

Return data: 0,"No error"

Common error code:

- 0 No error
- 100 Command error
- 102 Syntax error
- 108 Parameter not allowed
- 109 Missing parameter
- 113 Undefined header

- 121 Invalid character in number
 - 128 Numeric data not allowed
 - 131 Invalid suffix
 - 211 Trigger ignored
 - 220 Parameter error
 - 222 Data out of range
 - 224 Illegal parameter
 - 230 Data corrupt or stale
 - 256 File not found
 - 340 Calibration failed
 - 350 Queue overflow
 - 363 Input buffer overrun
 - 410 Query interrupted
-

:SYST:VERSion?

Function : It queries the system version that includes software, firmware and calibration version.

Description :

Query syntax: SYST:VERSion?

Return data: 1.350,20.0430,19.0521

:SYST:SER?

Function : It queries the serial number of the instrument.

Description :

Query syntax: SYST:SER?

Return data: GEP000000

MEASure Subsystem

:MEASure:PARAMeter
 {OFF|RDC|LS|LP|CS|CP|Q|D|RS|RP|Z|DEG|RAD|R|X|Y|G|B}
 :MEASure:PARAMeter?

Function : It sets or queries the measurement parameter (1~4 items) at present.

Description :

Set parameter OFF, RDC(DC Resistance), Ls(Series Inductance), Lp(Parallel Inductance), Cs (Series Capacitance), Cp (Parallel Capacitance), Q (Quality Factor), D (Dissipation Factor), Rs (Series Resistance) Rp(Parallel Resistance), Z(Impedance), θ d(Angle), θ r(Diameter), R(Resistance), X(Reactance), Y (Admittance), G (Conductivity), B (Susceptance).

Set syntax :MEASure:PARAMeter RDC,Z,DEG,OFF

RDC is the first measure parameter, the second is Z, the third is θ_{deg} , and the forth is OFF.

Query syntax :MEASure:PARAMeter?

Return data RDC,Z,DEG,OFF

:MEASure:FREQuency<frequency NR3/disc>
 :MEASure:FREQuency?

Function : It sets or queries the FREQUENCY.

Description :

Set parameter The setup value of frequency is {10.0~50000000.0(depending on the model)|MAXimum|MINimum}.

Set syntax :MEASure:FREQuency 1000

:MEASure:FREQuency1K

:MEASure:FREQuency 1KHZ

:MEASure:FREQuency 1E3

:MEASure:FREQuency MAXimum

:MEASure:FREQuency MINimum

Query syntax :MEASure:FREQuency?

Return data 1.000000E+03 (Format is in <NR3>)

:MEASure:SPEEd

{MAXimum|FAST|MEDIum|SLOW|SLOW2|0|1|2|3|4}

:MEASure:SPEEd?

Function : It sets or queries the SPEED.

Description :

Set parameter MAXimum/0, FAST/1, MEDIum/2,
SLOW/3,SLOW2/4

Set syntax :MEASure:SPEEd 1

:MEASure:SPEEd FAST

Query syntax :MEASure:SPEEd?

Return data FAST (Format is in <disc>)

:MEASure:BEEPer {OFF|PASS|OK|FAIL|NG|0|1|2}

:MEASure:BEEPer?

Function : It sets or queries the BEEP WHEN.

Description :

Set parameter OFF, PASS|OK, FAIL|NG

Set syntax :MEASure:BEEPer PASS

:MEASure:BEEPer NG

:MEASure:BEEPer OFF

Query syntax :MEASure:BEEPer?

Return data PASS| FAIL| OFF

:MEASure:VOLTage:AC <voltage NR3/disc>

:MEASure:VOLTage:AC?

Function : It sets or queries the AC measurement voltage (LEVEL).

Description :

Set parameter When RO (output impedance) is setting 100Ω, the
setup value of AC voltage is {0.01~2|MAXimum|MINimum}. When

RO (output impedance) is setting 25 Ω , the setup value of AC voltage is {0.01~1|MAXimum|MINimum}.

Set syntax :MEASure:VOLTage:AC 1
 :MEASure:VOLTage:AC 1000m
 :MEASure:VOLTage:AC 1000mv
 :MEASure:VOLTage:AC 1E+00
 :MEASure:VOLTage:AC MAXimum
 :MEASure:VOLTage:AC MINimum

Query syntax :MEASure:VOLTage:AC?

Return data 1.000000E+00 (Format is in <NR3>)

When the Level setup is current mode, the data returns 9.9E37.

:MEASure:VOLTage:DC <voltage NR3/disc>

:MEASure:VOLTage:DC?

Function : It sets or queries the DC measurement voltage (LEVEL).

Description :

Set parameter The value of DC voltage is {0.01~1|MAXimum|MINimum}.

Set syntax : MEASure:VOLTage:DC 10mv
 :MEASure:VOLTage:DC 10E-3
 :MEASure:VOLTage:DC 1
 :MEASure:VOLTage:DC MAXimum
 :MEASure:VOLTage:DC MINimum

Query syntax :MEASure:VOLTage:DC?

Return data 1.000000E-02 (Format is in <NR3>)

When the Level setup is current mode, the data returns 9.9E37.

:MEASure:CURREnt:AC <current NR3/disc>

:MEASure:CURREnt:AC?

Function : It sets or queries the AC measurement current (LEVEL).

Description :

Set parameter When RO(output impedance) is setting 100 Ω , the setup value of AC current is {0.0001~0.01|MAXimum|MINimum}.

When RO (output impedance) is setting 25 Ω , the setup value of AC

current is {0.0004~0.04|MAXimum|MINimum}.

Set syntax :MEASure:CURRent:AC 0.01
 :MEASure:CURRent:AC 10m
 :MEASure:CURRent:AC 1E-2
 :MEASure:CURRent:AC MAXimum
 :MEASure:CURRent:AC MINimum

Query syntax :MEASure:CURRent:AC?

Return data +4.000000E-04 (Format is in <NR3>)

When the Level setup is voltage mode, the data returns 9.9E37.

:MEASure:CURRent:DC <current NR3/disc>

:MEASure:CURRent:DC?

Function : It sets or queries the DC measurement current (LEVEL).

Description :

Set parameter The value of DC current is
 {0.0002~0.04|MAXimum|MINimum}.

Set syntax :MEASure:CURRent:DC 0.01
 :MEASure:CURRent:DC 20m
 :MEASure:CURRent:DC 1E-2
 :MEASure:CURRent:AC MAXimum
 :MEASure:CURRent:AC MINimum

Query syntax :MEASure:CURRent:DC?

Return data 2.000000E-04 (Format is in <NR3>)

When the Level setup is voltage mode, the data returns 9.9E37.

:MEASure:ALC {OFF|ON|0|1}

:MEASure:ALC?

Function : It sets or queries the ALC.

Description :

Set parameter ON|1, OFF|0

Set syntax: MEASure:ALC ON

Query syntax :MEASure:ALC?

Return data When the setup is OFF, it returns 0.

When the setup is ON, it returns 1.

:MEASure:SMONitor {0|1|OFF|ON}
:MEASure:SMONitor?

Function : It sets or queries the DISPLAY Vm/Im

Description :

Set parameter ON|1, OFF|0

Set syntax:MEASure: SMONitor ON

Query syntax :MEASure: SMONitor?

Return data When the setup is OFF, it returns 0.

When the setup is ON, it returns 1.

:FETCH:SMONitor:DC?

Function : It queries the DC voltage and current.

Description :

Query syntax :FETCH:SMONitor:DC?

Return data 1.000000E-03,3.791975E-02 Vm,Im(Format is in <NR3>)

:FETCH:SMONitor:AC?

Function : It queries the AC voltage and current.

Description :

Query syntax :FETCH:SMONitor:AC?

Return data 1.000000E-03,3.791975E-02 Vm,Im(Format is in <NR3>)

:MEASure:AVERage <average NR1>
:MEASure:AVERage?

Function : It sets or queries the AVERAGE.

Description :

Set parameter The value of the Average is {0~64}

Set syntax :MEASure:AVERageage 10

Query syntax :MEASure:AVERageage?

Return data 10 (Format is in <NR1>)

:MEASure:TRIGger:DElay <delay time NR3/disc>
:MEASure:TRIGger:DElay?

Function : It sets or queries the TRIGGER DELAY.

Description :

Set parameter The value of delay time is
{0.000~5.000|MAXimum|MINimum}.

Set syntax :MEASure:TRIGger:DElay 0.5
 :MEASure:TRIGger:DElay 0.5s
 :MEASure:TRIGger:DElay 500ms
 :MEASure:TRIGger:DElay 5E-1
 :MEASure:TRIGger:DElay MAXimum
 :MEASure:TRIGger:DElay MINimum

Query syntax :MEASure:TRIGger:DElay?

Return data 0.500 (Format is in <NR2>)

:MEASure:DElay <delay time NR3/disc>
:MEASure:DElay?

Function : It sets or queries the AC/DC DELAY.

Description :

Set parameter The value of delay time is
{0.000~5.000|MAXimum|MINimum}.

Set syntax :MEASure:DElay 3
 :MEASure:DElay 3s
 :MEASure:DElay 3000ms
 :MEASure:DElay 3E+00
 :MEASure:DElay MAXimum
 :MEASure:DElay MINimum

Query syntax :MEASure:DElay?

Return data 3.000 (Format is in <NR2>)

:MEASure:TRIGger:MODE {REPeat|0|SINGle|1}
:MEASure:TRIGger:MODE?

Function : It sets or queries the TRIGGER MODE.

Description :

Set parameter REPeat,0(repeat), SINGle,1 (single)

Set syntax :MEASure:TRIGger:MODE 1

:MEASure:TRIGger:MODE SINGle

Query syntax :MEASure:TRIGger:MODE?

Return data SING (Format is in <disc>)

When the setup is 0, it returns REP , When the setup is 1, it returns SING

:MEASure:RANGe:DC {1|2|3|4|AUTO|HOLD}
:MEASure:RANGe:DC?

Function : It sets or queries the DC RANGE.

Description :

Set parameter {1|2|3|4|AUTO|HOLD}

Set syntax :MEASure:RANGe:DC 2

:MEASure:RANGe:DC AUTO

Query syntax :MEASure:RANGe:DC?

Return Data 2 (Format is in <NR1>)

The range recommends setting as<Auto>in order to obtain better measuring accuracy.

The range actually measured will be displayed at the lower-left corner of LCD panel.

Further, there are also <1-30Ω all frequency>, <2-300Ω frequency below 1.2 MHz>, <3-3KΩ frequency below 120 KHz> and<4-30KΩ frequency below 12 KHz> ranges for option.

Faster measuring speed can be achieved when setting at “Range Hold”.

:MEASure:RANGe:AC {1|2|3|4|AUTO|HOLD}
:MEASure:RANGe:AC?

Function : It sets or queries the AC RANGE.

Description :

Set parameter {1|2|3|4|AUTO|HOLD}

Set syntax :MEASure:RANGe:AC 3

:MEASure:RANGe:AC AUTO

Query syntax :MEASure:RANGe:AC?

Return data 3 (Format is in <NR1>)

The range recommends setting as<Auto>in order to obtain better measuring accuracy.

The range actually measured will be displayed at the lower-left corner of LCD panel.

Further, there are also <1-30Ω all frequency>, <2-300Ω frequency below 1.2 MHz>, <3-3KΩ frequency below 120 KHz> and<4-30KΩ frequency below 12 KHz> ranges for option.

Faster measuring speed can be achieved when setting at “Range Hold”.

:MEASure:OIMPedance {100|25}
:MEASure:OIMPedance?

Function : It sets or queries the RO.

Description :

Set syntax: MEASure:OIMPedance 100

Query syntax :MEASure:OIMPedance?

Return data 100|25 (Format is in <NR1>)

:MEASure:COMParator:PARAMeter {1|2|3|4}
:MEASure:COMParator:PARAMeter?

Function : It sets or queries which parameters number is to be compared.

Description :

Set syntax :MEASure:COMParator:PARAMeter 3 (After this command, every compared setup is at this parameters number.)

Query syntax :MEASure:COMParator:PARAMeter?

Return data 3 (Format is in <NR1>)

:MEASure:COMParator:STATe {OFF|ON|0|1}

:MEASure:COMParator:STATe?

Function : It sets or queries the COMP enabled/disabled.

Description : :MEASure:COMParator:STATe?

Set syntax :MEASure:COMParator:STATe ON

Query syntax :MEASure:COMParator:STATe?

Return data When the setup is OFF, it returns 0.

When the setup is ON, it returns 1.

:MEASure:COMParator:MODE

<ABSolute|DEViation|PERCent|0|1|2>

:MEASure:COMParator:MODE?

Function : It sets or queries the COMP MODE.

Description :

Set parameter ABSolute,0|DEViation,1|PERCent,2

Set syntax :MEASure:COMParator:MODE PERCent

Query syntax :MEASure:COMParator:MODE?

Return data PERC (Format is in <disc>)

:MEASure:COMParator:NOMinal <nominal value NR3>

:MEASure:COMParator:NOMinal?

Function : It sets or queries the NOMINAL.

Description :

Set syntax :MEASure:COMParator:NOMinal 1000

:MEASure:COMParator:NOMinal 1K

:MEASure:COMParator:NOMinal 1E+03

Query syntax :MEASure:COMParator:NOMinal?

Return data 1.000000E+03 (Format is in <NR3>)

:MEASure:COMParator:UPPER <UPPER limit NR3>
:MEASure:COMParator:UPPER?

Function : It sets or queries the UPPER.

Description :

Set syntax :MEASure:COMParator:UPPER 1
 :MEASure:COMParator:UPPER 1000m
 :MEASure:COMParator:UPPER 1E+00

Query syntax :MEASure:COMParator:UPPER?

Return data 1.000000E+00 (Format is in <NR3>)

:MEASure:COMParator:LOWER <LOWER limit NR3>
:MEASure:COMParator:LOWER?

Function : It sets or queries the LOWER.

Description :

Set syntax :MEASure:COMParator:LOWER -1
 :MEASure:COMParator:LOWER -1000m
 :MEASure:COMParator:LOWER -1E+00

Query syntax :MEASure:COMParator:LOWER?

Return data -1.000000E+00 (Format is in <NR3>)

:MEASure:COMParator:DISPlay
<ABSolute|DEVIation|PERCent|0|1|2>
:MEASure:COMParator:DISPlay?

Function : It sets or queries the DISP MODE.

Description :

Set parameter ABSolute,0|DEVIation,1|PERCent,2

Set syntax :MEASure:COMParator:MODE DEVIation

Query syntax :MEASure:COMParator:MODE?

Return data DEV(Format is in <disc>)

:MEASure:BIN:PARAMeter
 {OFF|RDC|LS|LP|CS|CP|Q|D|RS|RP|Z|DEG|RAD|R|X|Y|G|B}
 :MEASure:BIN:PARAMeter?

Function : It sets or queries the BIN Parameter.

Description :

Set syntax :MEASure:BIN:PARAMeter Z (only allow the parameter which is being used under the meter mode.)

Query syntax :MEASure:PARAMeter?

Return data Z (Format is in <disc>)

:MEASure:BIN:NUMBer {2|3|4|5|6|7|8|9|MAXium|MINimum}
 :MEASure:BIN:NUMBer?

Function : It sets or queries the BIN NUMBER.

Description :

Set parameter The value of bin number is {2~9|MAXimum|MINimum}.

Set syntax :MEASure:NUMBer 4

Query syntax :MEASure:NUMBer?

Return data 4 (Format is in <NR1>)

:MEASure:BIN:METHod
 {EQUal|SEQuential|TOLerance|RANDom|0|1|2|3}
 :MEASure:BIN:METHod?

Function : It sets or queries the BIN METHOD.

Description :

Set parameter EQUal,0|SEQuential,1| TOLerance,2|RANDom,3

Set syntax: MEASure:BIN:METHod SEQ

Query syntax: MEASure:BIN:METHod?

Return data SEQ (Format is in <disc>)

:MEASure:BIN:MODE <ABSolute|DEVIation|PERCent|0|1|2>
:MEASure:BIN:MODE?

Function : It sets or queries the BIN MODE.

Description :

Set parameter ABSolute,0|DEVIation,1|PERCent,2

Set syntax :MEASure:BIN:MODE DEVIation

Query syntax :MEASure:BIN:MODE:MODE?

Return data DEV(Format is in <disc>)

When the setup is 0, it returns ABS, When the setup is 1, it returns DEV , When the setup is 2, it returns PERC.

:MEASure:BIN:NOMinal <nominal value NR3 >
:MEASure:BIN:NOMinal?

Function : It sets or queries the BIN NOMINAL.

Description :

Set syntax :MEASure:BIN:NOMinal 1000

:MEASure:BIN:NOMinal 1K

:MEASure:BIN:NOMinal 1E+03

Query syntax :MEASure:BIN:NOMinal?

Return data 1.000000E+03 (Format is in <NR3>)

:MEASure:BIN:LIMit <nominal value NR3 >
:MEASure:BIN:LIMit?

Function : It sets or queries the BIN LIMIT.

Description :

Set syntax :MEASure:BIN:LIMit 0.001,100M,1k,1000k

Query syntax :MEASure:BIN:LIMit?

Return data +1.000000E-03, +1.000000E-01, +1.000000E+03,
+1.000000E+06 (Format is in <NR3>)

:MEASure:FILE:LOAD <filename>

Function : It loads the meter mode's file.

Description :

Set syntax :MEASure:FILE:LOAD ABC.(load the file "ABC")

:MEASure:FILE:LOAD?

Function : It queries the meter mode's filename which is being using.

Description :

Query syntax :MEASure:FILE:LOAD?

Return data ABC

:MEASure:FILE:NEW <filename>

Function : It creates a new MEAS file with filename.

Description :

Set syntax : MEASure:FILE:NEW ABC

:MEASure:FILE:SAVE <filename>

Function : It creates a new MEAS file with filename and keeps previous settings in the new file.

Description :

Set syntax : MEASure:FILE:SAVE ABC

:MEASure:FILE:DELEte <filename>

Function : It deletes a MEAS file named filename.

Description :

Set syntax : MEASure:FILE:DELEte ABC

:MEASure:FILE?

Function : It queries all of the meter mode's filenames that are stored in the memory.

Description :

Query syntax : MEASure:FILE?

Return data: N, filename1, filename2, filename3, ..., filenameN
where N= total file count

:MEASure:BIAS:VOLTage<NR2>

:MEASure:BIAS:VOLTage?

Function : It sets or queries the BIAS Voltage.

Description :

Set parameter The value of BIAS Voltage -12.000~12.000

Set syntax : MEASure:BIAS:VOLTage -12

Query syntax : MEASure:BIAS:VOLTage?

Return data: -1.200000E+01

:MEASure:BIAS:STATe<ON|OFF|0|1>

:MEASure:BIAS:STATe?

Function : It sets or queries the BIAS Voltage enabled/disabled

Description :

Set syntax : MEASure:BIAS:STATe 1

Query syntax : MEASure:BIAS:STATe?

Return data: When the setup is OFF, it returns 0.
When the setup is ON, it returns 1.

:MEASure:STATistic {ON|OFF|0|1}

:MEASure:STATistic?

Function : It sets or queries the statistic function in the meter mode.

Description :

Set parameter: {ON|OFF|0|1}

Set syntax : MEASure:STATistic 1

Query syntax : MEASure:STATistic?

Return data: 0|1

where 0 = statistic function is disabled.

1 = statistic function is enabled.

:MEASure:STATistic:COUNT <pass count, fail count>

:MEASure:STATistic:COUNT?

Function : It sets or queries the statistical data in the meter mode

Description :

Set parameter: <pass count, fail count> (format is in NR1)

The value of pass count and fail count 0~999999999

Set syntax : MEASure:STATistic:COUNT 0,1

Query syntax : MEASure:STATistic:COUNT?

Return data: n1,n2

where n1= pass count (format is in NR1)

n2= fail count (format is in NR1)

:FETCh?

Function: It fetches the measurement data currently test mode.

There are two options for trigger and query:

1. Give command *TRG? or :TRIG? and get measuring result (recommend)
 2. Give command :TRIG for trigger and give :FETCh? to get measuring result To be sure currently step is under MEAS mode, or give command :DISP:PAGE MEAS to enter MEAS mode.
-

Description :

Query syntax FETC?

Return data

Meter Mode

Read Data format under Meter Mode

<para 1 data>,<para 2 data>,<para 3 data>,<para 4 data>,<status>,<bin number>,<para 1 compare status>,<para2 compare status>,<para 3 compare

status>,<para 4 compare status>

para 1-4 data

During value measuring, not all of four values will be displayed. The value will be displayed when the parameters are available. For example, if only two parameters are enabled, then only two values will be transmitted.

status – Measuring status, and the weighted value of each status refers to the final value.

0 – Normal status without special status and without comparison.

1 – Measuring schedule error

2 – ALC error

4 – Other errors

8 – Reserve

16 – All parameters OK

32 – Some parameters NG

bin number – Categorization result, and such value will not be displayed when the bin function is disabled.

-1 – bin out, not in the categorization number

1 ~ 9 – bin number, the categorization result is 1~9.

para compare status 1-4

Measuring comparison result: If any parameter comparison function is enabled, then the comparison result will be displayed for all of the parameters.

0 – No comparison

1 – Parameter comparison result OK

2 – Parameter comparison result NG

Multi-step Test Mode

Value transmit mode under Multi-step Test Mode.

<result>,<bin number>,<step 1 result>,<step 1 data>,<step 2 result>,<step 2 data>,<step 3 result>,<step 3 data>.....<step n result>,<step n data>

result – Finally judged test result

0 – Test not interrupted. Not completed

1 – Test steps all OK

2 – NG occurs to the test step

bin number - categorization result, and such value will not be displayed when closing the bin function.

-1 - bin out not in the categorization number

1-9 - bin number the categorization result is 1-9

step result

0 – no test

1 – test OK

2 – test NG

step data

test value

:FETCH:SMONitor:DC?

Function : It queries the DC voltage and current.

Description :

Query syntax : FETCH:SMONitor:DC?

Return data: 1.000000E-03,3.791975E-02 Vm,Im(Format is in <NR3>)

:FETCH:SMONitor:AC?

Function : It queries the AC voltage and current.

Description :

Query syntax : FETCH:SMONitor:AC?

Return data: 1.000000E-03,3.791975E-02 Vm,Im (Format is in <NR3>)

:FETCh:MODE {0|1|QUERy|AUTO}

:FETCh:MODE?

Function : Sets or queries fetch mode for the instrument.

Description :

Set parameter: 0|1|QUERy|AUTO

Set syntax : FETCh:MODE 1

Query syntax: FETCh:MODE?

When 0 or QUERy, The instrument send out the measurement data after receiving a query command.

When 1 or AUTO, When a measurement is completed, the instrument send out the measurement data automatically, even if it isn't triggered by command.

Under normal circumstance, the instrument returns the measurement data only when it receives a query or a measurement is triggered by a command over the interface such as "*TRG" or ":TRIG?".

Setting fetch mode to AUTO allows user to change this behavior. This function is especially useful when you need to collect data which is triggered from the handler or operator.

Care should be taken that the instrument resets the fetch mode to QUERY state at power-on.

:CORRection:OPEN

:CORRection:OPEN?

Function : It sets or queries to do open correction.

Description :

Set syntax: :CORRection:OPEN

Query syntax :CORRection:OPEN?

Return data When correction fail, it returns 0.

When correction passes, it returns 1.

:CORRection:SHORT

:CORRection:SHORT?

Function : It sets or queries to do short correction.

Description :

Set syntax: :CORRection:SHORT

Query syntax :CORRection:SHORT?

Return data When correction fail, it returns 0.

When correction passes, it returns 1.

:CORRection:OPEN:STATe {OFF|ON|0|1}
:CORRection:OPEN:STATe?

Function : It sets or queries the status of open correction.

Description :

Set syntax: CORRection:OPEN:STATe ON

Query syntax :CORRection:OPEN:STATe?

Return data When the setup is OFF, it returns 0.

When the setup is ON, it returns 1.

:CORRection:SHORT:STATe {OFF|ON|0|1}
:CORRection:SHORT:STATe?

Function : It sets or queries the status of short correction.

Description :

Set syntax: CORRection:SHORT:STATe ON

Query syntax :CORRection:SHORT:STATe?

Return data When the setup is OFF, it returns 0.

When the setup is ON, it returns 1.

:CORRection:CABLE {0|0.75|1|2}
:CORRection:CABLE?

Function : It sets or queries the status of cable length correction.

Description :

Set syntax: CORRection:CABLE 1

Query syntax :CORRection:CABLE?

Return data 0|0.75|1|2

:CORRection:HF
:CORRection:HF?

Function : It performs the high frequency load correction.

Description : CORRection:HF To perform high frequency load correction with no result feedback. CORRection:HF? To perform high frequency load correction with result feedback.

Set syntax :CORRection:HF

Query syntax :CORRection:HF?

Return data 0|1

where 0= The result of high frequenct load correction is failed

1= The result of high frequenct load correction is passed

:CORRection:HF:STATe {ON|OFF|0|1}

:CORRection:HF:STATe?

Function : It sets or queries the state of high frequency load correction.

Description :

Set parameter : {ON|OFF|0|1}

Set syntax : CORRection:HF:STATe ON

Query syntax : CORRection:HF:STATe?

Return data 0|1

where 0= High frequency load correction function is disabled.

1= High frequenct load correction function is enabled.

:CORRection:LOAD

:CORRection:LOAD?

Function : It performs the spot load correction.

Description : CORRection:LOAD To perform spot load correction with no result feedback. CORRection:LOAD? To perform spot load correction with result feedback.

Set syntax : CORRection:LOAD

Query syntax : CORRection:LOAD?

Return data 1

where 1= The result of spot load correction is passed

:CORRection:LOAD:STATe {ON|OFF|0|1}
:CORRection:LOAD:STATe?

Function : It sets or queries the state of spot load correction.

Description :

Set parameter : {ON|OFF|0|1}

Set syntax : CORRection:LOAD:STATe ON

Query syntax : CORRection:LOAD:STATe?

Return data 0|1

where 0= Spot load correction function is disabled.

1= Spod load correction function is enabled.

:CORRection:FIXTure {OFF|LCR-05A|LCR-10A|LCR-15A}
:CORRection:FIXTure?

Function : It sets or queries the state of spot load correction.

Description :

Set parameter {ON|OFF|0|1}

Set syntax : CORRection:FIXTure ON

Query syntax : CORRection:FIXTure?

Return data OFF|LCR-05A|LCR-10A|LCR-15A

:CORRection:LOAD:SPOT <spot number 1-16>
:CORRection:LOAD:SPOT?

Function : It sets or queries the load correction spot number that has been currently edited.

Description :

Set parameter : <spot number 1-16> (format is in NR1)

Set syntax : CORRection:LOAD:SPOT 1

Query syntax : CORRection:LOAD:SPOT?

Return data 1

```
:CORRection:LOAD:FREQuency <frequency in NR3>
:CORRection:LOAD:FREQuency?
```

Function : It sets or queries the load frequency for the current load correction spot.

Description :

Set parameter : <frequency> (format is in NR3), The spot is disabled if frequency is 0.

Set syntax : CORRection:LOAD:FREQuency 100k

Query syntax : CORRection:LOAD:FREQuency?

Return data +1.000000E+05 (Format is in NR3).

```
:CORRection:LOAD:FUNcTion {LS-Q|LS-RS|LP-Q|LP-RP|CS-D|CS-
RS|CP-D|CP-RP|R-X|G-B|Z-DEG|Y-DEG}
:CORRection:LOAD:FUNcTion?
```

Function : It sets or queries the load function for the current load correction spot.

Description :

Set parameter : {LS-Q|LS-RS|LP-Q|LP-RP|CS-D|CS-RS|CP-D|CP-RP|R-X|G-B|Z-DEG|Y-DEG}

Set syntax : CORRection:LOAD:FUNcTion LS-Q

Query syntax : CORRection:LOAD:FUNcTion?

Return data LS-Q

:CORRection:LOAD:REFeRence <reference A,reference B>
:CORRection:LOAD:REFeRence?

Function : It sets or queries the load reference values for the current load correction spot.

Description :

Set parameter : Reference A, reference B (format is in NR3)

Set syntax : CORRection:LOAD:REFeRence 2E-03,40

Query syntax : CORRection:LOAD:REFeRence?

Return data +2.000000E-03,+4.000000E+01

:CORRection:LOAD:VALue <load A,load B>
:CORRection:LOAD:VALue?

Function : It sets or queries the load values for the current load correction spot.

Description :

Set parameter : load A,load B (format is in NR3)

Set syntax : CORRection:LOAD:VALue 2E+03,0.4

Query syntax : CORRection:LOAD:VALue?

Return data +2.000000E+03,+4.000000E-01

LIST Subsystem

:LIST:STEP{1|2|3|4|...|14|15}

:LIST:STEP?

Function : It sets or queries the step to edit.

Description :

Set parameter step number 1~15

Set syntax :LIST:STEP 1

Query syntax :LIST:STEP?

Return data 1 (Format is in <NR1>)

:LIST:PARAMeter

{OFF|RDC|LS|LP|CS|CP|Q|D|RS|RP|Z|DEG|RAD|R|X|Y|G|B}

:LIST:PARAMeter?

Function : It sets or queries the measurement parameter of list mode.

Description :

Set syntax :LIST:PARAMeter Z

Query syntax :LIST:PARAMeter?

Return data Z (Format is in <disc>)

:LIST:FREQuency <frequencyNR3/disc>

:LIST:FREQuency?

Function : It sets or queries the measurement frequency of list mode.

Description :

Set parameter frequency 10.0~30000000.0 (depending on the model),

MAXimum/MINimum。

Set syntax :LIST:FREQuency 1000

:LIST:FREQuency 1K

:LIST:FREQuency 1KHZ

```
:LIST:FREQuency 1E3
:LIST:FREQuency MAXimum
:LIST:FREQuencyMINimum
```

Query syntax :LIST:FREQuency?

Return data 1.000000E+03 (Format is in <NR3>)

```
:LIST:VOLTage<voltage NR3/disc >
```

```
:LIST:VOLTage?
```

Function : It sets or queries the measurement voltage of list mode.

Description :

Set parameter When RO(output impedance) is 100Ω, the setup range of AC voltage is {0.01~2|MAXimum|MINimum}. When RO(output impedance) is setting 25Ω, the setup range of AC voltage is {0.01~1|MAXimum|MINimum}. The range of DC voltage is {0.01~1|MAXimum|MINimum}.

Set syntax :LIST:VOLTage 1

```
:LIST:VOLTage 1000m
:LIST:VOLTage 1E+00
:LIST:VOLTage MAXimum
:LIST:VOLTage MINimum
```

Query syntax :LIST:VOLTage?

Return data 1.000000E-02 (Format is in <NR3>)

When the Level setup is current mode, the data returns 9.9E37.

```
:LIST:CURREnt <current NR3/disc >
```

```
:LIST:CURREnt?
```

Function : It sets or queries the measurement current of list mode.

Description :

Set parameter when RO(output impedance) is 100Ω, the setup range of AC current is {0.0001~0.02|MAXimum|MINimum}. When RO(output impedance) is setting 25Ω, the setup range of AC current is {0.0004~0.04|MAXimum|MINimum}.

Set syntax :LIST:CURREnt 0.001

```
:LIST:CURREnt 1m
```

:LIST:CURRent 1E-3
 :LIST:CURRent MAXimum
 :LIST:CURRent MINimum

Query syntax :LIST:CURRent?

Return data 1.000000E-04 (Format is in <NR3>)

When the Level setup is current mode, the data returns 9.9E37.

:LIST:SPEED {MAXimum|FAST|MEDIUM|SLOW|SLOW2|0|1|2|3|4}
 :LIST:SPEED?

Function : It sets or queries the SPEED of list mode.

Description :

Set parameter MAXimum/0, FAST/1, MEDIUM/2, SLOW/,SLOW2/4

Set syntax :LIST:SPEED 1

:LIST:SPEED FAST

Query syntax :LIST:SPEED?

Return data FAST (Format is in <disc>)

:LIST:DELAy <delay time NR3/disc>
 :LIST:DELAy?

Function : It sets or queries the DELAY of list mode.

Description :

Set parameter The range of delay time is
 {0.000~5.000|MAXimum|MINimum}.

Set syntax :LIST:DELAy 0.5

:LIST:DELAy 500m

:LIST:DELAy 5E-3

:LIST:DELAy MAXimum

:LIST:DELAyMINimum

Query syntax :LIST:DELAy?

Return data 0.500 (Format is in <NR2>)

:LIST:COMParator:MODE
<ABSolute|DEVIation|PERCent|OFF|0|1|2>
:LIST:COMParator:MODE?

Function : It sets or queries the COMP MODE of list mode.

Description :

Set parameter ABSolute,0|DEVIation,1|PERCent,2|OFF

Set syntax :LIST:COMParator:MODE PERCent

Query syntax :LIST:COMParator:MODE?

Return data PERC (Format is in <disc>)

When the setup is 0, it returns ABS, When the setup is 1, it returns DEV , When the setup is 2, it returns PERC.

:LIST:COMParator:NOMinal <nominal value NR3 >
:LIST:COMParator:NOMinal?

Function : It sets or queries the NOMINAL of list mode.

Description :

Set syntax :LIST:COMParator:NOMinal 1000

:LIST:COMParator:NOMinal 1K

:LIST:COMParator:NOMinal 1E+03

Query syntax :LIST:COMParator:NOMinal?

Return data 1.000000E+03 (Format is in <NR3>)

:LIST:COMParator:UPPER <upper limit NR3>
:LIST:COMParator:UPPER?

Function : It sets or queries the UPPER of list mode.

Description :

Set syntax :LIST:COMParator:UPPER 1

:LIST:COMParator:UPPER1000m

:LIST:COMParator:UPPER 1E+00

Query syntax :LIST:COMParator:UPPER?

Return data 1.000000E+00 (Format is in <NR3>)

:LIST:COMParator:LOWER <LOWER limit NR3>
 :LIST:COMParator:LOWER?

Function : It sets or queries the LOWER of list mode.

Description :

Set syntax :LIST:COMParator:LOWER -1

:LIST:COMParator:LOWER -1000m

:LIST:COMParator:LOWER -1E+00

Query syntax :LIST:COMParator:LOWER?

Return data -1.000000E+00 (Format is in <NR3>)

:LIST:BIN:STEP {1|2|3|4|...|14|15}
 :LIST:BIN:STEP?

Function : It sets or queries the BIN Parameter Step of list mode.

Description :

Set parameter step number 1~15

Set syntax :LIST:BIN:STEP 3

Query syntax :LIST:BIN:STEP?

Return data 3 (Format is in <NR1>)

When the BIN set OFF, the data returns 0.

:LIST:BIN:PARAMeter
 {OFF|RDC|LS|LP|CS|CP|Q|D|RS|RP|Z|DEG|RAD|R|X|Y|G|B|}
 :LIST:BIN:PARAMeter?

Function : It sets or queries the BIN Parameter of list mode. ◻

Description :

Set syntax :LIST:BIN:PARAMeter Z (only allow the parameter which is being used under the list mode.)

Query syntax :LIST:PARAMeter?

Return data Z (Format is in <disc>)

:LIST:BIN:NUMBer {2|3|4|5|6|7|8|9|MAXium|MINimum}
:LIST:BIN:NUMBer?

Function : It sets or queries the BIN NUMBER of list mode.

Description :

Set parameter The value of bin number is
{2~9|MAXimum|MINimum}.

Set syntax :LIST:NUMBer 4

Query syntax :LIST:NUMBer?

Return data 4 (Format is in <NR1>)

:LIST:BIN:METHod
{EQual|SEquential|TOLerance|RANdom|0|1|2|3}
:LIST:BIN:METHod?

Function : It sets or queries the BIN METHOD of list mode.

Description :

Set parameter EQual,0| SEquential,1|TOLerance,2 |RANdom,3

Set syntax :LIST:BIN:METHod SEQ

Query syntax :LIST:BIN:METHod?

Return data SEQ (Format is in <disc>)

:LIST:BIN:MODE <ABSolute|DEVIation|PERCent|0|1|2>
:LIST:BIN:MODE?

Function : It sets or queries the BIN MODE of list mode.

Description :

Set parameter ABSolute,0|DEVIation,1|PERCent,2

Set syntax :LIST:BIN:MODE DEVIation

Query syntax :LIST:BIN:MODE?

Return data DEV (Format is in <disc>)

:LIST:BIN:NOMinal <nominal value NR3 >
:LIST:BIN:NOMinal?

Function : It sets or queries the BIN NOMINAL of list mode.

Description :

Set syntax :LIST:BIN:NOMinal 1000

:LIST:BIN:NOMinal 1K

:LIST:BIN:NOMinal 1E+03

Query syntax :LIST:BIN:NOMinal?

Return data 1.000000E+03 (Format is in <NR3>)

:LIST:BIN:LIMit <nominal value NR3 >
:LIST:BIN:LIMit?

Function : It sets or queries the BIN LIMIT of list mode.

Description :

Set syntax :LIST:BIN:BIN:LIMit 0.001,100M,1k,1000k

Query syntax :LIST:BIN:BIN:LIMit?

Return data +1.000000E-03, +1.000000E-01, +1.000000E+03,
+1.000000E+06 (Format is in <NR3>)

:LIST:TRIGger:MODE {REPeat|SINGle|AUTO}
:LIST:TRIGger:MODE?

Function : It sets or queries the TRIGGER MODE of list mode.

Description :

Set parameter REPeat, SINGle, AUTO

Set syntax :LIST:TRIGger:MODE AUTO

Query syntax :LIST:TRIGger:MODE?

Return data AUTO (Format is in <disc>)

:LIST:TRIGger:DELAy <delay time NR3/disc>
:LIST:TRIGger:DELAy?

Function : It sets or queries the TRIGGER DELAY of list mode.

Description :

Set parameter The value of delay time is
{0.000~5.000|MAXimum|MINimum}.

Set syntax :LIST:TRIGger:DELAy 0.5
 :LIST:TRIGger:DELAy 500m
 :LIST:TRIGger:DELAy 5E-1
 :LIST:TRIGger:DELAy MAXimum
 :LIST:TRIGger:DELAy MINimum

Query syntax :LIST:TRIGger:DELAy?

Return data 0.500 (Format is in <NR2>)

:LIST:OIMPedance {100|25}
:LIST:OIMPedance?

Function : It sets or queries the RO of list mode.

Description :

Set syntax : LIST:OIMPedance 25

Query syntax :LIST:OIMPedance?

Return data 25 (Format is in <NR1>)

:LIST:ALC {OFF|ON|0|1}
:LIST:ALC?

Function : It sets or queries the ALC of list mode.

Description :

Set syntax : LIST:ALC ON

Query syntax :LIST:ALC?

When the setup is OFF, it returns 0.

When the setup is ON, it returns 1.

:LIST:BEEPer {OFF|PASS|OK|FAIL|NG|0|1|2}
:LIST:BEEPer?

Function : It sets or queries the BEEP WHEN of list mode.

Description :

Set parameter OFF, PASS|OK, FAIL|NG

Set syntax :LIST:BEEPerPASS

:LIST:BEEPer NG

:LIST:BEEPer OFF

Query syntax :LIST:BEEPer?

Return data PASS |FAIL |OFF (Format is in <disc>)

:LIST:RANGe {AUTO|HOLD|0|1}
:LIST:RANGe?

Function : It sets or queries the RANGE of list mode.

Description :

Set parameter If selecting <ON>, the measuring range is hold at the range, which is used by the first time measuring. If selecting <OFF>, the most suitable test range is set automatically.

Set syntax :LIST:RANGe AUTO

:LIST:RANGe 1

Query syntax :LIST:RANGe?

Return data AUTO |HOLD (Format is in <disc>)

:LIST:RETest {OFF|STEP|ALL|0|1|2}
:LIST:RETest?

Function : It sets or queries the FAIL RETEST of list mode.

Description :

Set parameter It retests continuously until the test result is pass, when the test result is fail. If selecting <OFF>, it doesn't execute this function. If selecting <STEP 1>, only the first step is going to be retested. If selecting <ALL>, no matter which step occur fail result, the fail step is going to be retested until the result become pass.

Set syntax :LIST:RETest STEP

:LIST:RETest 2

:LIST:RETest OFF

Query syntax :LIST:RETest?

Return data OFF | STEP | ALL (Format is in <disc>)

:LIST:FILE:LOAD <filename>

Function : It loads the list file.

Description :

Set syntax :LIST:FILE:LOAD ABC.(Load the file "ABC")

:LIST:FILE:LOAD?

Function : It queries the list mode's filename which is being using.

Description :

Query syntax :LIST:FILE:LOAD?

Return data ABC

:LIST:FILE:NEW <filename>

Function : It creates a new LIST file with filename.

Description :

Set syntax : LIST:FILE:NEW ABC

:LIST:FILE:SAVE <filename>

Function : It creates a new LIST file with filename and keeps previous settings in the new file.

Description :

Set syntax : LIST:FILE:SAVE ABC

:LIST:FILE:DELEte <filename>

Function : It deletes a LIST file named filename.

Description :

Set syntax : LIST:FILE:DELEte ABC

:LIST:FILE?

Function : It queries all of the list mode's filenames that are stored in the memory.

Description :

Query syntax: LIST:FILE?

Return data N,filename1,filename2,filename3,...,filenameN
where N= total file count

:LIST:BIAS:VOLTage <NR3>

:LIST:BIAS:VOLTage?

Function : It sets or queries the BIAS Voltage of list mode.

Description :

Set parameter: The value of BIAS Voltage -12.000~12.000

Set syntax: LIST:BIAS:VOLTage 6

Query syntax: LIST:BIAS:VOLTage?

Return data +6.000000E+00

:LIST:STATistic {ON|OFF|0|1}
:LIST:STATistic?

Function : It sets or queries the statistic function in the list mode.

Description :

Set parameter: {ON|OFF|0|1}

Set syntax: LIST:STATistic 1

Query syntax: LIST:STATistic?

Return data 0|1

where 0= statistic function is disabled.

1= statistic function is enabled.

:LIST:STATistic:COUNt <pass count, fail count>
:LIST:STATistic:COUNt?

Function : It sets or queries the statistical data in the list mode.

Description :

Set parameter: <pass count, fail count> (format is in NR1)

The value of pass count and fail count 0~999999999

Set syntax: LIST:STATistic:COUNt 0.1

Query syntax: LIST:STATistic:COUNt?

Return data n1,n2

where n1= pass count (format is in NR1)

n2= fail count (format is in NR1)

SWEEP Subsystem

When it is in sweep mode, only the correction spot load setting will have no effect.

```
:SWEep:TYPE {FREQuency|VAC|IAC|BIASV}
:SWEep:TYPE?
```

Function : It sets or queries the sweep type.

Description :

Set parameter FREQuency | VAC(voltage) | IAC(current) | BIASV(DC Bias)

Set syntax :SWEep:TYPE FREQuency

Query syntax :SWEep:TYPE?

Return data FREQ | VAC | IAC | BIASV (Format is in <disc>)

```
:SWEep:XAXis {LOGarithm|LINear}
:SWEep:XAXis?
```

Function : It sets or queries the XAXIS.

Description :

Set parameter LOGarithm | LINear

Set syntax :SWEep:XAXis LOGarithm

Query syntax :SWEep:XAXis?

Return data LOG | LIN (Format is in <disc>)

```
:SWEep:XAXis:DATA?
```

Function : It queries the XAXIS data.

Description :

Query syntax :SWEep:XAXis:DATA?

Return data

+1.000000E+03,+1.209960E+05,+2.409920E+05,+3.609880E+05,...+
3.000000E+07(Format is in <NR3>)

:SWEep:START <startNR3/disc>
:SWEep:START?

Function : It sets or queries the START.

Description :

Set parameter The start value of frequency is
{10.0~50000000.0|MAXimum|MINimum}.

The start value of voltage AC RO 100Ω is
{0.01~2|MAXimum|MINimum}.

The start value of voltage AC RO 25Ω is
{0.01~1|MAXimum|MINimum}.

The start value of current AC RO 100Ω is
{0.0002~0.02|MAXimum|MINimum}.

The start value of current AC RO 25Ω is
{0.0002~0.04|MAXimum|MINimum}.

Set syntax :SWEep:START 1000

:SWEep:START 1k

:SWEep:START 1E+3

:SWEep:START MAXimum

:SWEep:START MINimum

Query syntax :SWEep:START?

Return data +1.000000E+03 (Format is in <NR3>)

:SWEep:STOP <stopNR3/disc>
:SWEep:STOP?

Function : It sets or queries the STOP.

Description :

Set parameter The stop value of frequency is
{10.0~50000000.0|MAXimum|MINimum}.

The stop value of voltage AC RO 100Ω is
{0.01~2|MAXimum|MINimum}.

The stop value of voltage AC RO 25Ω is
{0.01~1|MAXimum|MINimum}.

The stop value of current AC RO 100Ω is

{0.0002~0.02|MAXimum|MINimum}.

The stop value of current AC RO 25Ω is

{0.0002~0.04|MAXimum|MINimum}.

Set syntax : SWEep:STOP 1000000

:SWEep:STOP 1M

:SWEep:STOP 1E+6

:SWEep:STOP MAXimum

:SWEep:STOP MINimum

Query syntax :SWEep:STOP?

Return data +1.000000E+06 (Format is in <NR3>)

:SWEep:FREQUency<frequencyNR3/disc>

:SWEep:FREQUency?

Function : It sets or queries the FREQ, when the TYPE setup is VAC or IAC.

Description :

Set parameter The value of frequency is

{10.0~50000000.0|MAXimum|MINimum}.

Set syntax :SWEep:FREQUency 1000

:SWEep:FREQUency 1K

:SWEep:FREQUency 1KHZ

:SWEep:FREQUency 1E3

:SWEep:FREQUency MAXimum

:SWEep:FREQUency MINimum

Query syntax :SWEep:FREQUency?

Return data 1.000000E+03 (Format is in <NR3>)

When the TYPE setup is FREQUency mode, the data returns 9.9E37.

:SWEep:VOLTage <voltage NR3/disc>

:SWEep:VOLTage?

Function : It sets or queries the LEVEL to voltage mode, when the TYPE setup is FREQ.

Description :

Set parameter The value of voltage AC RO 100Ω is

{0.01~2|MAXimum|MINimum}.

The value of voltage AC RO 25Ω is

{0.01~1|MAXimum|MINimum}.

Set syntax :SWEep:VOLTage 1

:SWEep:VOLTage 100m

:SWEep:VOLTage 100E-3

:SWEep:VOLTage MAXimum

:SWEep:VOLTage MINimum

Query syntax :SWEep:VOLTage?

Return data 1.000000E+03 (Format is in <NR3>)

When the LEVEL setup is not voltage mode, the data returns 9.9E37.

:SWEep:CURRent<currentNR3/disc>

:SWEep:CURRent?

Function : It sets or queries the LEVEL to current mode, when the TYPE setup is FREQ.

Description :

Set parameter The value of current AC RO 100Ω is

{0.0001~0.02|MAXimum|MINimum}.

The value of current AC RO 25Ω is

{0.0004~0.04|MAXimum|MINimum}.

Set syntax :SWEep:CURRent 0.001

:SWEep:CURRent 1m

:SWEep:CURRent 1E-3

:SWEep:CURRent MAXimum

:SWEep:CURRent MINimum

Query syntax :SWEep:CURRent?

Return data +1.000000E-04 (Format is in <NR3>)

When the LEVEL setup is not current mode, the data returns 9.9E37.

:SWEep:TRIGger:MODE <REPeat|SINGle|0|1>
:SWEep:TRIGger:MODE?

Function : It sets or queries the sweep trigger mode.

Description :

Set parameter REPeat,0 (repeat) , SINGle,1 (single)

Set syntax :SWEep:TRIGger:MODE SINGle

Query syntax :SWEep:TRIGger:MODE?

Return data REP | SING (Format is in <disc>)

:SWEep:SPEEd {FAST|MEDIum|SLOW|1|2|3}
:SWEep:SPEEd?

Function : It sets or queries the sweep speed.

Description :

Set parameter FAST/1, MEDIum/2, SLOW/3

Set syntax :SWEep:SPEEd 1

:SWEep:SPEEd FAST

Query syntax :SWEep:SPEEd?

Return data FAST |MED | SLOW (Format is in <disc>)

:SWEep:TRACe {A|B}
:SWEep:TRACe?

Function : It sets or queries which trace is in use.

Description :

Set syntax :SWEep:TRACe A

Querysyntax :SWEep:TRACe?

Return data A | B (Format is in <disc>)

```
:SWEep:FUNcTion
{LS|LP|CS|CP|Q|D|RS|RP|Z|DEG|RAD|R|X|Y|G|B,OFF|LS|LP|CS|CP
|Q|D|RS|RP|Z|DEG|RAD|R|X|Y|G|B }
:SWEep:FUNcTion?
```

Function : It sets or queries the sweep function.

Description :

Set parameter The comma is placed between the two parameters.

The first parameter cannot set to OFF.

Set syntax :SWEep:FUNcTion Z,DEG

Query syntax :SWEep:FUNcTion?

Return data Z,DEG (Format is in <disc>)

```
:SWEep:DELAy <delay timeNR3/disc>
:SWEep:DELAy?
```

Function : It sets or queries the sweep delay between measurement points.

Description :

Set parameter The value of delay time is {0.000~5.000|MAXimum|MINimum}.

Set syntax :SWEep:DELAy 0.5

:SWEep:DELAy 500M

:SWEep:DELAy 500MS

:SWEep:DELAy 5E-3

:SWEep:DELAy MAXimum

:SWEep:DELAyMINimum

Query syntax :SWEep:DELAy?

Return data 0.500 (Format is in <NR2>)

:SWEep:OIMPedance {100|25}
 :SWEep:OIMPedance?

Function : It sets or queries the output impedance of sweep mode.

Description :

Set syntax :SWEep:OIMPedance 100

Query syntax :SWEep:OIMPedance?

Return data 100|25 (Format is in <NR1>)

:SWEep:KEEP {OFF|ON|0|1}
 :SWEep:KEEP?

Function : It sets or queries the KEEP PREVIOUS TRACE.

Description :

Set syntax :SWEep:KEEP ON

:SWEep:KEEP 0

Query syntax :SWEep:KEEP?

Return data 1 | 0 (Format is in <disc>)

:SWEep:TRACA:PARAMeter
 {LS|LP|CS|CP|Q|D|RS|RP|Z|DEG|RAD|R|X|Y|G|B}
 :SWEep:TRACA:PARAMeter?

Function : It sets or queries the parameter of TRACE A

Description :

Set parameter The first parameter cannot be set to OFF.

Set syntax :SWEep:TRACA:PARAMeter Z

Query syntax :SWEep:TRACA:PARAMeter?

Return data Z (Format is in <disc>)

:SWEep:TRACA:YAXis {LOGarithm|LINear}
 :SWEep:TRACA:YAXis?

Function : It sets or queries the Y-AXIS of TRACE A.

Description :

Set parameter LOGarithm | LINear
Set syntax :SWEep:TRACA:YAXis LOGarithm
Query syntax :SWEep:TRACA:YAXis?
Return data LOG | LIN (Format is in <disc>)

:SWEep:TRACA:REFerence <value NR3>
:SWEep:TRACA:REFerence?

Function : It sets or queries the REF of TRACE A.

Description :

Set parameter The value can be set when Y-AXIS setup is linear mode.
Set syntax :SWEep:TRACA:REFerence 25k
Query syntax :SWEep:TRACA:REFerence?
Return data 2.500000E+03 (Format is in <NR3>)

:SWEep:TRACA:POSition {-10 ~ 16|MAXimun|MINimum}
:SWEep:TRACA:POSition?

Function : It sets or queries the position of TRACE A. When Y-axis setup is LOG| LINEAR mode, sets the LINEAR , POSition range as -5~5, sets the LOGarithm, POSition range as -10~16

Description :

Set parameter {-10 ~ 16|MAXimun|MINimum}
Set syntax :SWEep:TRACA:POSition -3
Query syntax :SWEep:TRACA:POSition?
Return data -3 (Format is in <NR1>)

:SWEep:TRACA:DIVision <value NR3/disc>
:SWEep:TRACA:DIVision?

Function : It sets or queries the division of TRACE A.

Description :

Set parameter The numeric value can only set 1, 2, 5 and 10 (when Y-axis setup is linear mode).

Set syntax :SWEep:TRACA:DIVision 2k
Query syntax :SWEep:TRACA:DIVision?
Return data 2.000000E+03 (Format is in <NR3>)
Return data +9.9E37 (when Y-axis setup is not linear mode)

:SWEep:TRACA:DECade {1~12}
:SWEep:TRACA:DECade?

Function : It sets or queries the decade of TRACE A.

Description :

Set parameter: The value of DECADE is {1~12} (when Y-axis setup is LOG mode).

Set syntax :SWEep:TRACA:DECade 5

Query syntax :SWEep:TRACA:DECade?

Return data 5 (Format is in <NR3>).

Return data +9.9E37 (when Y-axis setup is not LOG mode)

:SWEep:TRACA:MAXimun?

Function : It queries the maximum of TRACE A.

Description :

Query syntax :SWEep:TRACA:MAXimun?

Return data +2.230924E+06,+3.221517E-03.

:SWEep:TRACA:MINimum?

Function : It queries the minimum of TRACE A.

Description :

Query syntax :SWEep:TRACA:MINimum?

Return data +2.310130E+06,-3.446227E-03 (Format is in <NR3>).

:SWEep:TRACA:COLor <1|2|3|4|5|6>
 :SWEep:TRACA:COLor?

Function : It sets or queries colors for trace A.

Description :

Set syntax : SWEep:TRACA:COLor 1

The numbers stand for the colors as below

1 - light blue	4 - light red
2 - light green	5 - light magenta
3 - light cyan	6 - light yellow

Query syntax : SWEep:TRACA:COLor?

Return data 1|2|3|4|5|6

:SWEep:TRACA:RESult?

Function : It queries all of the value data of TRACE A.

Description :

Query syntax :SWEep:TRACA: RESult?

Return data +2.218913E-04,+2.215632E-04,+2.216804E-04...(Format is in <NR3>).

:SWEep:TRACB:PARAMeter
 {LS|LP|CS|CP|Q|D|RS|RP|Z|DEG|RAD|R|X|Y|G|B|}
 :SWEep:TRACA:PARAMeter?

Function : It sets or queries the PARA of TRACE B

Description :

Set parameter The first parameter can not be set to OFF.

Set syntax :SWEep:TRACB:PARAMeter Z

Query syntax :SWEep:TRACB:PARAMeter?

Return data Z (Format is in <disc>)

:SWEep:TRACB:YAXis {LOGarithm|LINear}
:SWEep:TRACB:YAXis?

Function : It sets or queries the Y-AXIS of TRACE A.

Description :

Set parameter LOGarithm | LINear

Set syntax :SWEep:TRACB:YAXis LOGarithm

Query syntax :SWEep:TRACB:YAXis?

Return data LOG | LIN (Format is in <disc>)

:SWEep:TRACB:REFeRence <value NR3>
:SWEep:TRACB:REFeRence?

Function : It sets or queries the reference value of TRACE B.

Description :

Set parameter The value can be set when Y-AXIS setup is linear mode.

Set syntax :SWEep:TRACB:REFeRence 25k

Query syntax :SWEep:TRACB:REFeRence?

Return data 2.500000E+04 (Format is in <NR3>)

:SWEep:TRACB:POSition {-10 ~ 16|MAXimun|MINimum}
:SWEep:TRACB:POSition?

Function : It sets or queries the position of TRACE B. When Y-axis setup is LOG| LINEAR mode, sets the LINEAR, POSition range as -5~5, sets the LOGarithm, POSition range as -10~16.

Description :

Set parameter {-10 ~ 16|MAXimun|MINimum}

Set syntax :SWEep:TRACB:POSition -3

Query syntax :SWEep:TRACB:POSition?

Return data -3 (Format is in <NR1>)

:SWEep:TRACB:DIVision <value NR3/disc>
:SWEep:TRACB:DIVision?

Function : It sets or queries the DIV of TRACE B.

Description :

Set parameter The numeric value can only be set to 1, 2, 5 and 10 (when Y-axis setup is linear mode).

Set syntax :SWEep:TRACB:DIVision 2k

Query syntax :SWEep:TRACB:DIVision?

Return data 2.000000E+03 (Format is in <NR3>)

Return data +9.9E37 (when Y-axis setup is not linear mode)

:SWEep:TRACB:DECade {1~12}
:SWEep:TRACB:DECade?

Function : It sets or queries the DECADE of TRACE B.

Description :

Set parameter The value of DECADE is {1~12} (when Y-axis setup is LOG mode).

Set syntax :SWEep:TRACB:DECade 5

Query syntax :SWEep:TRACB:DECade?

Return data 5 (Format is in <NR3>).

Return data +9.9E37 (when Y-axis setup is not LOG mode)

:SWEep:TRACB:MAXimun?

Function : It queries the maximum of TRACE B and corresponding frequency | voltage | current.

Description :

Query syntax :SWEep:TRACB:MAXimun?

Return data +2.230924E+06,+3.221517E-03 (Format is in <NR3>). The first data is the corresponding frequency | voltage | current. The second data is the maximum.

:SWEep:TRACB:MINimum?

Function : It queries the minimum of TRACE B and corresponding frequency | voltage | current.

Description :

Query syntax :SWEep:TRACB:MINimum?

Return data +2.310130E+06,-3.446227E-03 (Format is in <NR3>).The first data is the corresponding frequency | voltage | current. The second data is the minimum.

:SWEep:TRACB:COLor <1|2|3|4|5|6>**:SWEep:TRACB:COLor?**

Function : It sets or queries colors for trace B.

Description :

Set syntax : SWEep:TRACB:COLor 1

The numbers stand for the colors as below

1 - light blue	4 - light red
2 - light green	5 - light magenta
3 - light cyan	6 - light yellow

Query syntax : SWEep:TRACB:COLor?

Return data 1|2|3|4|5|6

:SWEep:TRACB:RESult?

Function : It queries all of the value data of TRACE B.

Description :

Query syntax :SWEep:TRACB: RESult?

Return data +2.218913E-04,+2.215632E-04,+2.216804E-04...(Format is in <NR3>).

:SWEep:AUToscale

Function : It does the auto scale function.

Description :

Set syntax: SWEep:AUToscale

:SWEep:RESult?

Function : It queries all of the value data of TRACE A and TRACE B.

Description :

Query syntax :SWEep:RESult?

Return data +2.218913E-04,+2.215632E-04,+2.216804E-04...(Format is in <NR3>). It uploads the TRACE A data at the beginning. It starts uploading TRACE B data when finish uploading TRACE A data.

:SWEep:BIAS:VOLTage<NR3>

:SWEep:BIAS:VOLTage?

Function : It sets or queries the BIAS Voltage of sweep Mode.

Description :

Set syntax: SWEep:BIAS:VOLTage 3

Query syntax: SWEep:BIAS:VOLTage?

Return data: +3.000000E+00

:SWEep:ANALysis:MODEl {A|B|C|D|E|F|G|OFF}

:SWEep:ANALysis:MODEl?

Function: It sets or queries the Analysis Model.

Description:

Set syntax: SWEep:ANALysis:MODEl A

Query syntax: SWEep:ANALysis:MODEl?

Return data: A(Format is in <disc>)

:SWEep:ANALysis:TRACA:COLor <0|1|2|3|4|5|6|7|8|9|10|11|12>

:SWEep:ANALysis:TRACA:COLor?

Function : It sets or queries colors for analysed trace A.

Description :

Set syntax : SWEep:ANALysis:TRACA:COLor 7

The numbers stand for the colors as below

1 - light blue

7 - dark blue

2 - light green

8 - dark green

3 - light cyan	9 - dark cyan
4 - light red	10 - dark red
5 - light magenta	11 - dark magenta
6 - light yellow	12 - dark yellow

Query syntax : SWEEp:ANALysis:TRACa:COLor?

Return data 0|1|2|3|4|5|6|7|8|9|10|11|12

:SWEEp:ANALysis:TRACB:COLor <0|1|2|3|4|5|6|7|8|9|10|11|12>
:SWEEp:ANALysis:TRACB:COLor?

Function : It sets or queries colors for analysed trace B.

Description :

Set syntax : SWEEp:ANALysis:TRACB:COLor 7

The numbers stand for the colors as below

1 - light blue	7 - dark blue
2 - light green	8 - dark green
3 - light cyan	9 - dark cyan
4 - light red	10 - dark red
5 - light magenta	11 - dark magenta
6 - light yellow	12 - dark yellow

Query syntax : SWEEp:ANALysis:TRACB:COLor?

Return data 0|1|2|3|4|5|6|7|8|9|10|11|12

:SWEEp:ANALysis:RESult?

Function: It queries all of the value data and corresponding frequency | voltage | current of TRACE A and TRACE B.

Description :

Query syntax: SWEEp:ANALysis:RESult?

Return data:

+1.000000E+03,+1.640668E+00,+8.338054E+01,+1.044400E+03,+1.712566E+00,+8.365955E+01,...(Format is in <NR3>). It uploads the TRACE A data at the beginning. It start uploading TRACE B data when finish uploading TRACE A data.

Return data: +9.9E37 (when analysis have no data or OFF)

:SWEep:ANALysis:CALCulate?

Function: It queries the data of R1, L1, C1, R0, C0, Qm are in the ANALYSIS mode.

Description :

Query syntax: SWEep:ANALysis:CALCulate?

Return data: +1.419038E+05,+2.593797E-04,+1.838886E-11,+1.891086E-01,+9.900000E+37,+3.778361E+010 (Format is in <NR3>)

Return data: +9.9E37 (when analysis have no data or OFF)

:SWEep:SRF:SERies?

Function: It queries the SRF fs (self-resonant frequency serial).

Description:

Query syntax: SWEep:SRF:SERies?

Return data: 1.517124E+06 (Format is in <NR3>)

Return data: +9.9E37 (when analysis have no data or OFF)

:SWEep:SRF:PARallel?

Function: It queries the SRF fp (self-resonant frequency parallel).

Description:

Query syntax: SWEep:SRF:PARallel?

Return data: +9.764006E+06 (Format is in <NR3>)

Return data: +9.9E37 (when analysis have no data or OFF)

A PPENDIX

Preset	244
Specifications	246
Typical	246
General	246
General Characteristics	246
Source Characteristics	247
Specifications	250
Dimensions	253
Certificate Of Compliance	254
Measurement Basics	255
Resistance (R) and Conductance (G)	256
Capacitance (C)	258
Inductance (L)	259
Reactance (X) and Susceptance (B)	260
Impedance (Z) and Admittance (Y)	262
Quality factor (Q) and Dissipation factor (D)	264
Phase angle (θ)	266
Overall Impedance Measurement Theory	267
Characteristics Example	271
High and low impedance criteria	273
Equivalent Circuit Model Analysis	274

Preset

The following are the default settings for the RESET on the Meter/Sweep/List setup page.

METER MODE (Applicable to create a new meter file)

MEAS DISPLAY	Default Setting
Parameter 1	Ls
Parameter 2	Q
Parameter 3	Z
Parameter 4	Deg
Frequency	1.0kHz
Level/RO/ALC	1V/100Ω/OFF
Speed	MED
TRIGGER MODE	REPEAT
BIAS	0V (Output OFF)
RANGE	AUTO
COMPARATOR	OFF
BIN	OFF
MEASURE MODE SETUP	Default Setting
TRIGGER DELAY	0
AC/DC DELAY	0
AVERAGE	1
DISPLAY V _m /I _m	OFF
BEEP WHEN	OFF
STATISTICS	OFF

SWEEP MODE

SWEEP DISPLAY	Default Setting
SWEEP TYPE	FREQUENCY
X-AXIS	LOG.
START	20Hz
STOP	50MHz (maximum frequency depends on the model)
LEVEL	0.5V
BIAS	0
TRIGGER	SINGLE
SPEED	FAST

FUNCTION	Z-Deg
TRACE A	
PARAMETER	Z
Y-AXIS	LOG.
REFERENCE	1
POSITION	+2 DECADE
DECADE	8
TRACE B	
PARAMETER	Deg
Y-AXIS	LINEAR
REFERENCE	0
POSITION	0
DIVISION	20Deg
ANALYSIS	
MODEL	OFF
SWEEP MODE SETUP	Default Setting
SWEEP DELAY	0
RO	100 Ω
KEEP PREVIOUS TRACE	OFF
TRACE A COLOR	YELLOW
TRACE B COLOR	GREEN
TRACE A SIMULATION COLOR	YELLOW
TRACE B SIMULATION COLOR	GREEN

LIST MODE (Applicable to create a new meter file)

LIST SET/LIST RUN DISPLAY	Default Setting
ALL STEPS	OFF
BIN	OFF
LIST MODE SETUP	Default Setting
TRIGGER MODE	SINGLE
TRIGGER DELAY 0	0
RO 100Ohm	100 Ω
ALC	OFF
BEEP WHEN	OFF
RANGE HOLD	OFF
FAIL RETEST	OFF
STATISTICS	OFF

Specifications

Warranted performance. All specification apply at 23 ± 5 °C, unless otherwise stated, and 30 minutes after the instrument has been turned on.

- Calibration: Yearly
- Reset adjustment: Perform correction before testing

Typical

Expected performance of an average. It is not covered by the product warranty.

General

Common descriptive terms do not mean performance. It is not covered by the product warranty.

General Characteristics

Specification Conditions:

Temperature: 18°C~28°C

Humidity: $\leq 70\%$ RH(non-condensing)

Operating Environment

Temperature Range: 5~40°C

Relative Humidity: $\leq 80\%$ RH(non-condensing)

Storage Conditions

Temperature Range: -10~70°C

Relative Humidity: $\leq 80\%$ RH(non-condensing)

General

Power Consumption: AC 100V~240V, 50/60Hz, Max65VA

Fuse: 250V 3.15A slow melting

Dimensions: 346 mm (W) X 145 mm (H) X 335 mm (D)

Weight: Approximately 3.3 kg

Display	7" LCD color display (800x480)
---------	--------------------------------

Range	Auto range, Hold range
-------	------------------------

Output Impedance(RO)	100/25Ω (25Ω:1Vac max)
----------------------	------------------------

Auto Level Control(ALC)	Standard
DC Bias	±12V
Correction	Open/Short/HF Load/Load
Sweep Parameters	Freq/Vac/Iac/DC BIAS, Keep Trace
List Parameters	Freq/Vac/Iac/DC BIAS/Comp/BIN, Auto Trigger
Average	1 to 64
V/I Monitor	Vac, Iac, Vdc, Idc
File Storage	Meter: 99 sets, List: 48 sets
Comparator	Value, Δ , $\Delta\%$
Handler	PASS, FAIL and OK, NG or BIN 1-9
Buzzer	OFF, Pass, Fail
Trigger	REPEAT, SINGLE
Interface	USB/GPIB/LAN/RS-232/Handler/USB Host/TRIGGER Input
Programming language	SCPI

Source Characteristics

Frequency																	
LCR-8250	DC, 10Hz~50MHz																
LCR-8230	DC, 10Hz~30MHz																
LCR-8220	DC, 10Hz~20MHz																
LCR-8210	DC, 10Hz~10MHz																
LCR-8205	DC, 10Hz~5MHz																
LCR-8201	DC, 10Hz~1MHz																
Accuracy	0.0007%±0.01Hz																
Range and Resolution																	
	<table border="1"> <thead> <tr> <th>Range</th> <th>Resolution</th> </tr> </thead> <tbody> <tr> <td>10.0 ~ 99.9Hz</td> <td>0.1Hz</td> </tr> <tr> <td>100.0 ~ 999.9Hz</td> <td>0.1Hz</td> </tr> <tr> <td>1.0000k ~ 9.9999kHz</td> <td>0.1Hz</td> </tr> <tr> <td>10.0000k ~ 99.9999kHz</td> <td>0.1Hz</td> </tr> <tr> <td>100.000k ~ 999.999kHz</td> <td>1Hz</td> </tr> <tr> <td>1.00000M ~ 9.99999MHz</td> <td>10Hz</td> </tr> <tr> <td>10.0000M ~ 50.0000MHz</td> <td>100Hz</td> </tr> </tbody> </table>	Range	Resolution	10.0 ~ 99.9Hz	0.1Hz	100.0 ~ 999.9Hz	0.1Hz	1.0000k ~ 9.9999kHz	0.1Hz	10.0000k ~ 99.9999kHz	0.1Hz	100.000k ~ 999.999kHz	1Hz	1.00000M ~ 9.99999MHz	10Hz	10.0000M ~ 50.0000MHz	100Hz
Range	Resolution																
10.0 ~ 99.9Hz	0.1Hz																
100.0 ~ 999.9Hz	0.1Hz																
1.0000k ~ 9.9999kHz	0.1Hz																
10.0000k ~ 99.9999kHz	0.1Hz																
100.000k ~ 999.999kHz	1Hz																
1.00000M ~ 9.99999MHz	10Hz																
10.0000M ~ 50.0000MHz	100Hz																
OPEN/SHORT Trimming Frequency Points																	
	10 20 50 100 200 500 1k 2k																

	5k	10k	20k	50k	100k	200k	500k	1M
	2M	5M	10M	20M	30M	50M		
Display Range								
Z	0.000mΩ to 9999.99MΩ							
R,X	± 0.000mΩ to 9999.99MΩ							
Cs, Cp	± 0.00000pF to 9999.99F							
Ls, Lp	± 0.00nH to 9999.99kH							
Q	0.00 to 9999.99							
D	0.00000 to 9999.99							
Y	0.00000μS to 999.999kS							
G, B	± 0.00000μS to 999.999kS							
θ _{DEG}	± 0.000° to 180.000°							
θ _{RAD}	± 0.00000 to 3.14159							
Δ%	± 0.000% to 999.999%							
DCR	0.00mΩ to 99.9999MΩ							
Voltage Signal Level *f: Measure frequency [MHz]								
Range	10mV ~ 2Vrms (f ≤ 1 MHz)							
	10mV ~ 1Vrms (f > 1MHz or f ≤ 1 MHz and RO=25Ω)							
Resolution	1mV							
Accuracy	4-Terminal test fixture ± [(10+0.05×f)%+1mV]							
	Cable length > 0m ± [(15+0.1×f)%+1mV]							

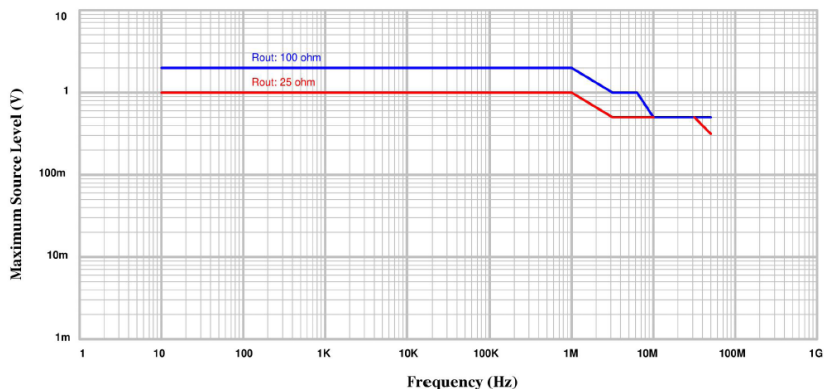

Current Signal Level		*f: Measure frequency [MHz]
Range	100μA~ 20mArms (RO=100Ω)	
	400μA~ 40mArms (RO=25Ω)	
Resolution	10μA	
Accuracy	4-Terminal test fixture	
	$f \leq 10\text{MHz}, +[10\%+50\mu\text{A}], -[(10+0.2 \times f^2)\%+50\mu\text{A}]$ $f > 10\text{MHz}, \pm[(10+0.3 \times f)\%+50\mu\text{A}]$	
Accuracy	Cable length>0m	
	$f \leq 5\text{MHz}, +[10\%+50\mu\text{A}], -[(15+1.5 \times f^2)\%+50\mu\text{A}]$	
	$f > 5\text{MHz}, \pm[(20+0.3 \times f)\%+50\mu\text{A}]$	
DCR Signal Level		
Signal Level	DC 1V, 40mA max	
Accuracy	±1%	
Output Impedance	25Ω (nominal)	
DC Bias		
Range	0 to ± 12 V	
Resolution	1 mV	
Accuracy	±(0.3% ± 2mV)	
Measurement Speed		
Max:	2.5ms (>10kHz)	
Fast:	50ms (>20Hz)	
Medium:	100ms	
Slow:	300ms	
Slow2:	600ms	
Display Time	1.6 ~ 5.6ms (depend on the contents)	

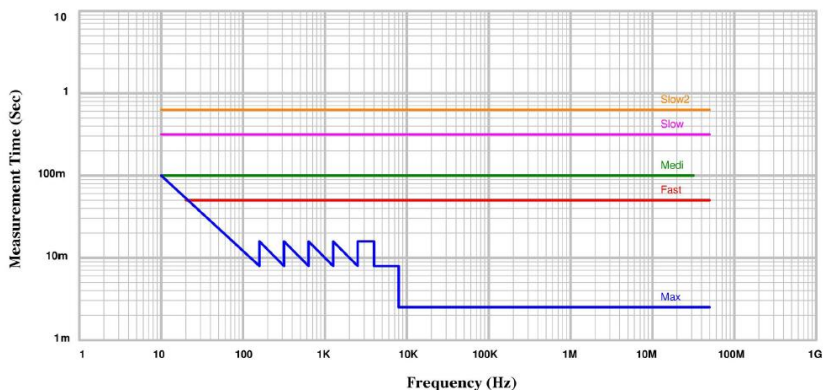

Specifications

Impedance measurement accuracy at 4-terminal test fixture
(Typical, frequency > 10 MHz)

|Z| basic accuracy Chart

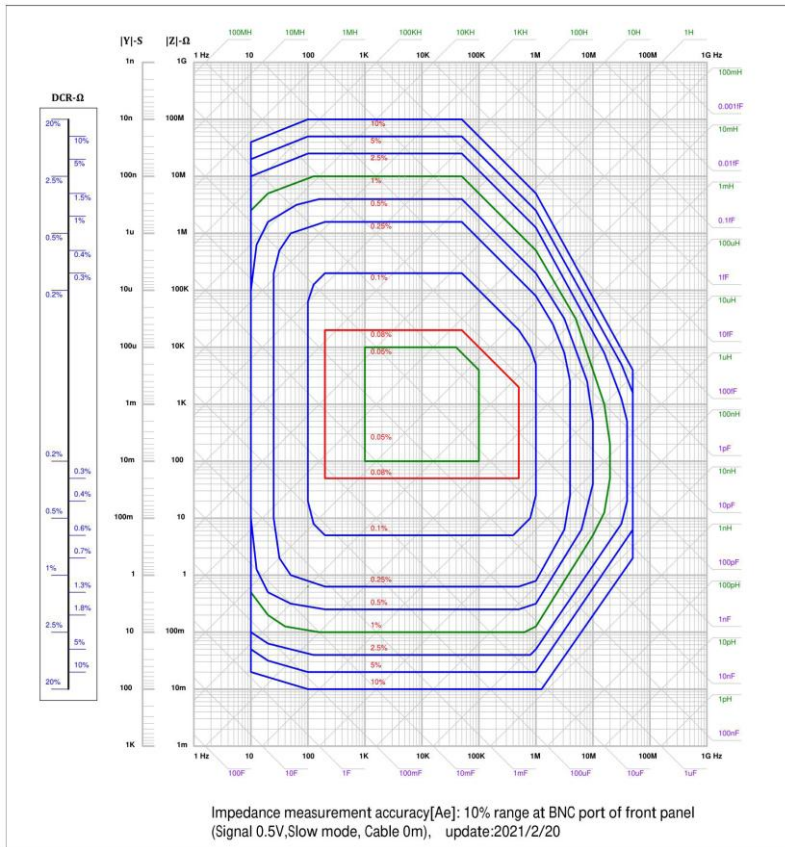

Ae accuracy

If the test conditions are not normal standard, additional calculations are required.

$$Ae = \pm (Ab + Az + Av + Ad + Ac) \times Kt \quad [\%]$$

Ab%	Measurement Frequency:.....F[Hz], Fm[MHz]
	Ab=0.08+(200/F-1) × 0.0222(F<200Hz)
	Ab=0.08(200Hz≤F≤500kHz)
	Ab=0.08+(Fm-0.5) × 0.0472(F>500kHz)
Az%	Impedance Range [Ω] :.....F[Hz], Fm[MHz]
	Zx≤100Ω:
	Zx: measurement value of Z
	Az=(100/Zx-1) × 0.001 × Km
	Km=1+(100/F-1) × 0.112 (F<100Hz)
	Km=1(100Hz≤F≤1MHz)
	Km=1+(Fm-1) × 3(F>1MHz)
	Zx>100Ω
	Az=(Zx/100-1) × 0.00001 × Kn × Kp
	Kn=1+(100/F-1) × 0.112(F<100Hz)
Kn=1(100Hz≤F≤50kHz)	
Kn=F/50000.....(F>50kHz)	
Kp=1(F≤1MHz)	
Kp=1+(Fm-1) × 0.5(F>1MHz)	
Av%	Measurement Signal Level [Vac] :..... F[Hz], Fm[MHz]
	Av=(Vac-0.5) ² × 0.45 × (1+Fm/30) (Vac>0.5V)
	Av=(0.5/Vac-1) × 0.25(Vac≤0.5V)
Ad%	Measurement Speed
	Ad=0(SLOW2)
	Ad=0(SLOW)
	Ad=0.1 (MED)
	Ad=0.2 (FAST)
Ad=0.4 (MAX)	
Ac%	Cable length [m]
	Ac=0(0m, Fm:0~50MHz)
	Ac=0.02+0.015 × Fm(0.75m, Fm:0~20MHz)
	Ac=0.02+0.02 × Fm(1m, Fm:0~10MHz)
Ac=0.02+0.03 × Fm(2m, Fm:0~5MHz)	

	Temperature [°C]
Kt	Kt=4 (8-18°C)
	Kt=1+(T-23) ² x 0.0139 (18-28°C)
	Kt=4 (28-38°C)

Measure parameter accuracy

Z , Y	±Ae [%], Where Relative accuracy Ae= ±(Ab+Az+Av+Ad+Ac) × Kt [%]
θ	±Ae/100 [rad]
L, C, X, B	±Ae [%](Dx≤0.1)
	±Ae×√(1+Dx ²) [%].....(Dx>0.1)
R	±Ae [%].....(Dx ≥ 10 or Qx ≤ 0.1)
Rs:	
	±Ae/Dx [%].....(Dx≤0.1 or Qx≥10)
	±Ae×√(1+Dx ²)/Dx [%](0.1<Dx<10 or 10>Qx>0.1)
Rp:	
	±Ae/(DxFAe/100) [%](Dx≤0.1 or Qx≥10)
	±Ae×√(1+Dx ²)/(DxFAe/100×√(1+Dx ²)) [%].....
(0.1<Dx<10 or 10>Qx>0.1)
G	±Ae/Dx [%](Dx≤0.1)
	±Ae×√(1+Dx ²)/Dx [%](Dx>0.1)
D	±Ae/100(Dx≤0.1)
	±Ae×(1+Dx)/100(0.1<Dx≤1)
Q	±(Qx ² ×Ae/100)/(1FQx ×Ae/100)
(Qx ×Da<1, Dx<0.1 or Qx>10)
	±(Qx ² ×Ae(1+Dx)/100)/(1FQx ×Ae(1+Dx)/100)
(Qx ×Da<1, Dx≥0.1 or Qx≤10)

Da: measurement accuracy of D, Dx: measurement value of D, Qx: measurement value of Q

Dimensions

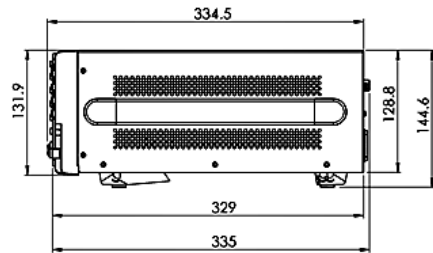
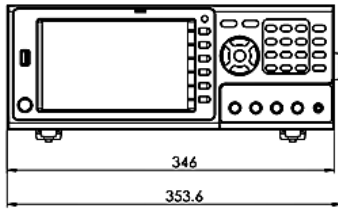
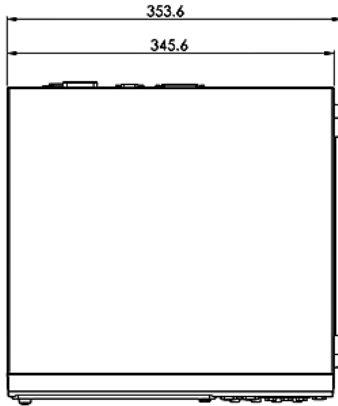

Certificate Of Compliance

We

GOOD WILL INSTRUMENT CO., LTD.

declare that the CE marking mentioned product satisfies all the technical relations application to the product within the scope of council:

Directive: EMC; LVD; WEEE; RoHS

The product is in conformity with the following standards or other normative documents:

◎ EMC	
EN 61326-1	Electrical equipment for measurement, control and laboratory use -- EMC requirements
Conducted & Radiated Emission EN 55011 / EN 55032	Electrical Fast Transients EN 61000-4-4
Current Harmonics EN 61000-3-2 / EN 61000-3-12	Surge Immunity EN 61000-4-5
Voltage Fluctuations EN 61000-3-3 / EN 61000-3-11	Conducted Susceptibility EN 61000-4-6
Electrostatic Discharge EN 61000-4-2	Power Frequency Magnetic Field EN 61000-4-8
Radiated Immunity EN 61000-4-3	Voltage Dip/ Interruption EN 61000-4-11 / EN 61000-4-34
◎ Safety	
EN 61010-1 :	Safety requirements for electrical equipment for measurement, control, and laboratory use - Part 1: General requirements

GOODWILL INSTRUMENT CO., LTD.

No. 7-1, Jhongsing Road, Tucheng District, New Taipei City 236, Taiwan

Tel: [+886-2-2268-0389](tel:+886-2-2268-0389)

Fax: [+886-2-2268-0639](tel:+886-2-2268-0639)

Web: <http://www.gwinstek.com>

Email: marketing@goodwill.com.tw

GOODWILL INSTRUMENT (SUZHOU) CO., LTD.

No. 521, Zhujiang Road, Snd, Suzhou Jiangsu 215011, China

Tel: [+86-512-6661-7177](tel:+86-512-6661-7177)

Fax: [+86-512-6661-7277](tel:+86-512-6661-7277)

Web: <http://www.instek.com.cn>

Email: marketing@instek.com.cn

GOODWILL INSTRUMENT EURO B.V.

De Run 5427A, 5504DG Veldhoven, The Netherlands

Tel: [+31-\(0\)40-2557790](tel:+31-(0)40-2557790)

Fax: [+31-\(0\)40-2541194](tel:+31-(0)40-2541194)

Email: sales@gw-instek.eu

Measurement Basics

To measure capacitance, inductance and resistance user can select series or parallel mode.

C(Capacitance) :

Series mode :

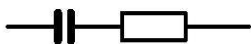

Series mode Equations :

$$C_s = C_p (1 + D^2)$$

D = dissipation factor

Parallel mode :

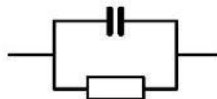

Parallel mode Equations :

$$C_p = \frac{C_s}{(1 + D^2)}$$

D = dissipation factor

L(Inductance) :

Series mode :

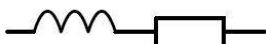

Series mode Equations :

$$L_s = \frac{L_p}{\left(1 + \frac{1}{Q^2}\right)}$$

Q = Quality Factor

Parallel mode :

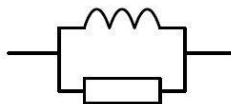

Parallel mode Equations :

$$L_p = L_s \left(1 + \frac{1}{Q^2}\right)$$

Q = Quality Factor

R (Resistance) :

Series mode :

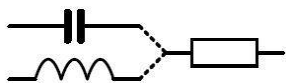

Series mode Equations :

$$R_s = \left(\frac{R_p}{1 + Q^2} \right)$$

Q = Quality Factor

Parallel mode :

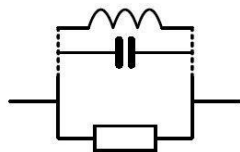

Parallel mode Equations :

$$R_p = R_s (1 + Q^2)$$

Q = Quality Factor

Resistance (R) and Conductance (G)

The resistance is a measure of the difficulty to pass an electric current through that conductor. The SI unit of resistance is the “ohm” (Ω). The inverse quantity is electrical conductance, and this is the ease with which an electric current passes through a circuit. The SI unit of conductance is measured in Siemens (S) and it the reciprocal of the resistance ($G=1/R$).

Resistance (R):

Measure Type : Series mode $\rightarrow R_s$ / Parallel mode $\rightarrow R_p$ / DC mode $\rightarrow R_{dc}$

Relevant Equations :

$$R = \frac{V}{I} = \frac{1}{G} = Z_s - jX = Z_s - j\omega L = Z_s + \frac{j}{\omega C}$$

$$|Z_s| = \sqrt{(R^2 + X^2)}$$

$$|Z_p| = \frac{RX}{\sqrt{(R^2 + X^2)}}$$

$$R_s = |Z| \cos \theta$$

Conductance (G):

Measure Type : Parallel mode → G_p(Conductance is measuring by parallel mode only.)

Relevant Equations :

$$G_p = \frac{I}{V} = \frac{1}{R} = Y_p - jB = Y_p - j\omega C = Y_p + \frac{j}{\omega L}$$

$$|Y_s| = \frac{GB}{\sqrt{(G^2 + B^2)}}$$

$$|Y_p| = \sqrt{(G^2 + B^2)}$$

$$G_p = |Y| \cos \theta$$

Capacitance (C)

Capacitance (denoted by the letter C) is the ability of a body to store an electrical charge at a given potential difference between its plates. The SI unit of capacitance is the farad (symbol: F).

Measure Type : Series mode→Cs / Parallel mode→Cp

Relevant Equations :

$$Z_s = R + jX = R + j\omega L = R - \frac{j}{\omega C}$$

$$Y_p = G + jB = G + j\omega C = G - \frac{j}{\omega L}$$

$$Q = \frac{\omega L_s}{R_s} = \frac{1}{\omega C_s R_s} \quad (\text{series R, L, C values})$$

$$Q = \frac{R_p}{\omega L_p} = \omega C_p R_p \quad (\text{parallel R, L, C values})$$

$$D = \frac{R_s}{\omega L_s} = \omega C_s R_s \quad (\text{series R, L, C values})$$

$$D = \frac{G_p}{\omega C_p} = \omega L_p G_p \quad (\text{parallel G, L, C values})$$

Inductance (L)

Inductance is the property of an electrical conductor by which a change in current through it induces an electromotive force (EMF) in both the conductor itself and in any nearby conductors by mutual inductance. In the SI system, the measurement unit for inductance is the Henry (with the unit symbol H).

Measure Type : Series mode → L_s / Parallel mode → L_p

Relevant Equations :

$$Z_s = R + jX = R + j\omega L = R - \frac{j}{\omega C}$$

$$Y_p = G + jB = G + j\omega C = G - \frac{j}{\omega L}$$

$$Q = \frac{\omega L_s}{R_s} = \frac{1}{\omega C_s R_s} \quad (\text{series R, L, C values})$$

$$Q = \frac{R_p}{\omega L_p} = \omega C_p R_p \quad (\text{parallel R, L, C values})$$

$$D = \frac{R_s}{\omega L_s} = \omega C_s R_s \quad (\text{series R, L, C values})$$

$$D = \frac{G_p}{\omega C_p} = \omega L_p G_p \quad (\text{parallel G, L, C values})$$

Reactance (X) and Susceptance (B)

In AC circuit analysis, reactance is represented by the capital letter “X” which is the imaginary part of complex impedance.

Reactance is the opposition of a circuit element to a change in the current or voltage, due to that element's inductance or capacitance which is similar to the opposition of resistance to current in a DC circuit. In an AC circuit (e.g. a series RLC circuit) inductance and capacitance may oppose current and are named reactance measured in units of Ohm (Ω).

In electrical engineering, susceptance (B) is the imaginary part of admittance. The inverse of admittance is impedance, and the real part of admittance is conductance. The latter is the reciprocal of impedance ($B=1/X$) and is measured in units of Siemens (S).

Reactance (X):

Measure Type : Series mode → Xs (Reactance is measuring by series mode only.)

Relevant Equations :

$$X = \frac{1}{B} = |Z| \sin \theta$$

$$|Z_s| = \sqrt{(R^2 + X^2)}$$

$$|Z_p| = \frac{RX}{\sqrt{(R^2 + X^2)}}$$

$$X_s = |Z| \sin \theta$$

Susceptance (B):

Measure Type : Parallel mode → B_p (Reactance is measuring by parallel mode only.)

Relevant Equations :

$$B = \frac{1}{X} = |Y| \sin \theta$$

$$|Y_s| = \frac{GB}{\sqrt{(G^2 + B^2)}}$$

$$|Y_p| = \sqrt{(G^2 + B^2)}$$

$$B_p = |Y| \sin \theta$$

Impedance (Z) and Admittance (Y)

The impedance covers oppositions in AC circuits including resistance, inductance, and capacitance and is measured in units of Ohm (Ω).

In electrical engineering, admittance covers both conductance and susceptance and is the reciprocal of impedance. It is measured in units of Siemens (S).

Impedance (Z):

Relevant Equations :

$$Z = \frac{E}{I} = \frac{1}{Y}$$

$$Z_s = R + jX = R + j\omega L = R - \frac{j}{\omega C}$$

$$|Z_s| = \sqrt{(R^2 + X^2)}$$

$$|Z_p| = \frac{RX}{\sqrt{(R^2 + X^2)}}$$

$$R_s = |Z| \cos \theta$$

$$X_s = |Z| \sin \theta$$

Admittance (Y):

Relevant Equations :

$$Y = \frac{I}{E} = \frac{1}{Z}$$

$$Y_p = G + jB = G + j\omega C = G - \frac{j}{\omega L}$$

$$|Y_s| = \frac{GB}{\sqrt{(G^2 + B^2)}}$$

$$|Y_p| = \sqrt{(G^2 + B^2)}$$

$$G_p = |Y| \cos \theta$$

$$B_p = |Y| \sin \theta$$

Quality factor (Q) and Dissipation factor (D)

The quality factor measures energies consumed by relative frequency. In general, the better a circuit's quality factor the better its selectivity.

The dissipation factor is the reciprocal of quality factor. It is the signal angle loss by a capacitor (or inductor) and acting frequency at a fixed temperature. Phase shifts caused by time lag between an externally applied voltage and current generated may result in loss of current and energy dissipation. Here the total current (I) is the sum of the charging current (I_C) by a 90° voltage phase shift and loss current (I_R) of the same voltage. The loss angle is the angle δ between the total current and charging current and $\tan\delta$ the dissipation factor (symbol: D) as shown in the figure below:

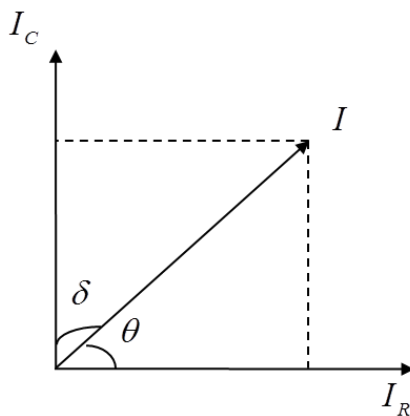

Quality factor (Q):

Relevant Equations :

$$Q = \frac{R_p}{\omega L_p} = \omega C_p R_p \quad (\text{series R, L, C values})$$

$$Q = \frac{\omega L_s}{R_s} = \frac{1}{\omega C_s R_s} \quad (\text{series R, L, C values})$$

$$Q = \frac{1}{\tan(90 - \theta)^\circ} = \frac{1}{D}$$

Dissipation factor (D):

Relevant Equations :

$$D = \frac{R_s}{\omega L_s} = \omega C_s R_s$$

$$D = \frac{G_p}{\omega C_p} = \omega L_p G_p$$

$$D = \tan(90 - \theta)^\circ = \frac{1}{Q}$$

Phase angle (θ)

This is the shift angle when measuring impedance (Z), admittance (Y), quality factor (Q) and dissipation factor (D).

Relevant equations :

$$Z_s = R + jX = R + j\omega L = R - \frac{j}{\omega C}$$

$$Y_p = G + jB = G + j\omega C = G - \frac{j}{\omega L}$$

$$Y_p = G + jB = G + j\omega C = G - \frac{j}{\omega L}$$

$$Q = \frac{1}{\tan(90 - \theta)^\circ} = \frac{1}{D} \quad D = \tan(90 - \theta)^\circ = \frac{1}{Q}$$

$$R_s = |Z| \cos \theta \quad X_s = |Z| \sin \theta$$

$$G_p = |Y| \cos \theta \quad B_p = |Y| \sin \theta$$

Overall Impedance Measurement Theory

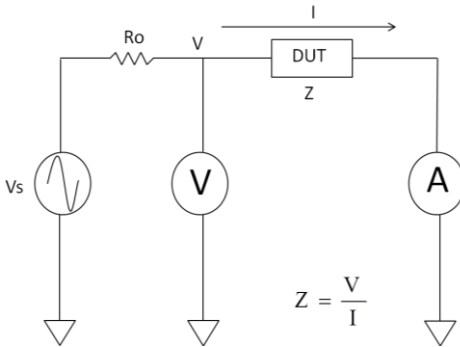

The simplified model of the LCR-8200 series impedance measurement, V_s is the test signal voltage and R_O is source resistance. If the current across the DUT is I when a test signal voltage V is applied, the DUT's impedance, Z , is expressed by $Z = \frac{V}{I}$. Impedance, Z , contains real and imaginary parts. The figure shows vector representation of impedance as follow.

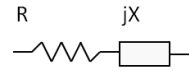
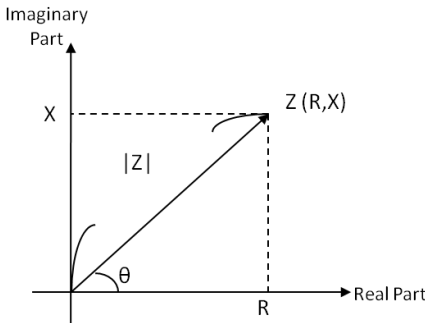

$$Z = R + jX = |Z| \angle \theta$$

$$\begin{cases} R = |Z| \cos \theta \\ X = |Z| \sin \theta \end{cases}$$

$$\begin{cases} |Z| = \sqrt{R^2 + X^2} \\ \theta = \tan^{-1} \left(\frac{X}{R} \right) \end{cases}$$

R: Resistance

X: Reactance

|Z|: Impedance

θ : Phase Angle

Impedance, Z , can also be expressed as admittance, Y . Admittance is expressed in terms of impedance, Z , by $Y = \frac{1}{Z}$.

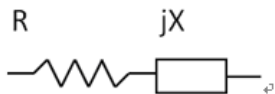

$$Y = \frac{1}{Z} = \frac{1}{R + jX} = \frac{R}{R^2 + X^2} - j \frac{X}{R^2 + X^2}$$

OR[⊙]

$$Y = \frac{1}{Z} = \frac{1}{|Z| \angle \theta} = |Y| \angle (-\theta)$$

For parallel connected circuits, it is better to use admittance, Y .

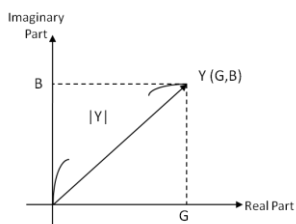

$$Z = \frac{jRX}{R + jX} = \frac{RX^2}{R^2 + X^2} + j \frac{R^2X}{R^2 + X^2}$$

(Impedance make it a bit complex)

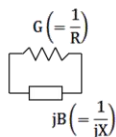

$$Y = G + jB$$

G: Conductance

B: Susceptance

|Y| : Admittance

The LCR-8200 series measures a DUT's impedance, Z , which is a vector value, and gives the result using the following equivalent circuits.

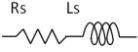
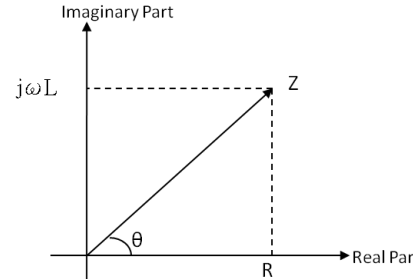
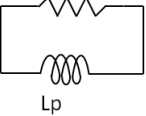
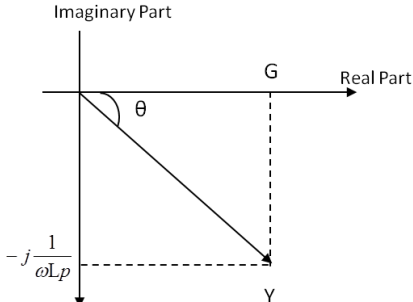
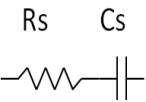
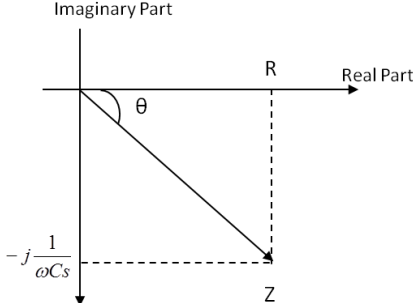
		$Z = R_s + jX = Z \angle \theta$ $X = \omega L_s$ $Z = R_s + j \omega L_s$ <p>Where $\omega = 2 \pi f$ (f : test frequency)</p>
		$Z = R_s + jX = Z \angle \theta$ $X = \omega L_s$ $Z = R_s + j \omega L_s$ <p>Where $\omega = 2 \pi f$ (f : test frequency)</p>
		$Z = R_s + jX = Z \angle \theta$ $X = -j \frac{1}{\omega C_s}$ $Z = R_s - j \frac{1}{\omega C_s}$ <p>Where $\omega = 2 \pi f$ (f : test frequency)</p>

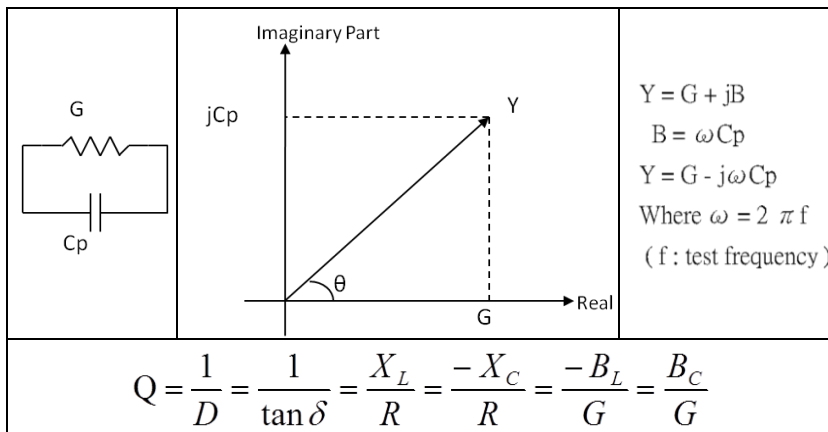

L_p : Parallel Inductance

L_s : Series Inductance

Q : Quality factor

C_p : Parallel Capacitance

C_s : Series Capacitance

D : Dissipation factor

Characteristics Example

As can be seen in the following figure, a component can have different effective parameter values dependent upon its operating condition. The measured values most useful in actual applications are obtained from precise measurement under the actual operating conditions.

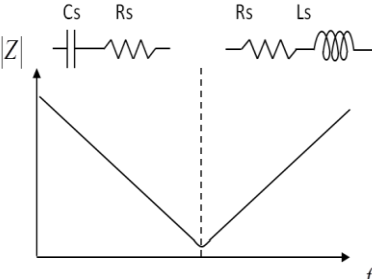
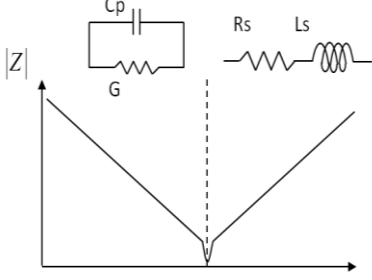
DUT	Characteristics Example	Measurement Functions
Large C		<p>Cs-Rs Cs-D Cs-Q R-X $Z - \angle\theta$</p>
Small C		<p>Cp-G Cp-D Cp-Q G-B $Y - \angle\theta$</p>

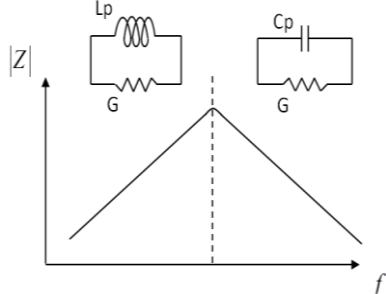
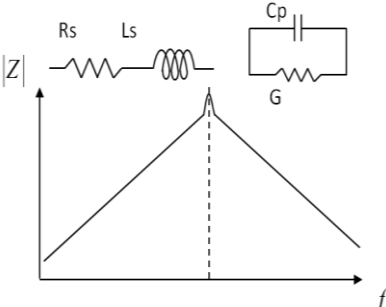
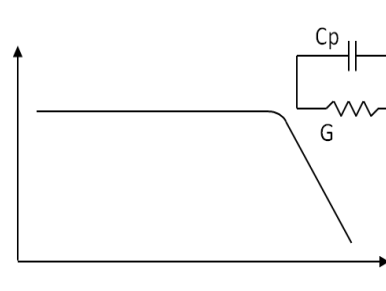
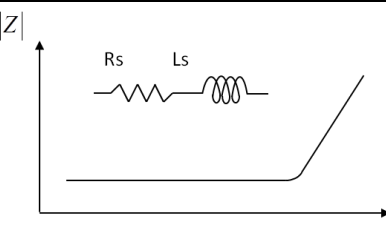
<p>Large L</p>		<p>Lp-G Lp-D Lp-Q G-B Y-$\angle\theta$</p>
<p>Small L</p>		<p>Ls-Rs Ls-D Ls-Q R-X Z-$\angle\theta$</p>
<p>Dut</p>	<p>Characteristics Example</p>	<p>Measurement Functions</p>
<p>Large R</p>		<p>Cp-G G-B Y-$\angle\theta$</p>
<p>Small R</p>		<p>Ls-Rs R-X Z-$\angle\theta$</p>

High and low impedance criteria

The following criteria can be used to roughly discriminate between low, middle, and high impedances by following figure. The medium Z range may be covered with an extension of either the low Z or high Z range. These criteria differ somewhat, depending on the frequency and component type.

In the frequency region where the primary capacitance or inductance of a component exhibits almost a flat frequency response, either a series or parallel equivalent circuit can be applied as a suitable model to express the real impedance characteristic. Practically, the simplest series and parallel models are effective in most cases when representing characteristics of general capacitor, inductor, and resistor components.

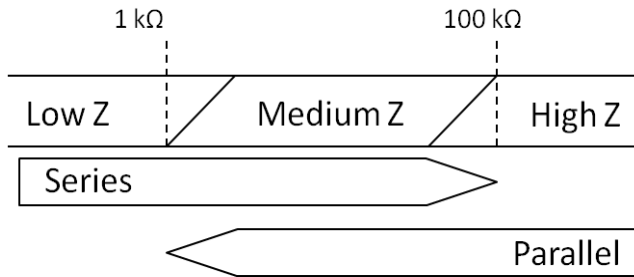

Equivalent Circuit Model Analysis

This function, which adopts the algorithm based on resonance theory, consists of 7 different equivalent circuit models. The 3-components analysis model is composed of 4 types, A, B, C and D, whereas the 4-components analysis model covers 3 types, E, F and G. By selecting suitable equivalent circuit model, the instrument will automatically calculate approximate value of each component parameter after measurement, and generate simulated curve (TRACE A/B SIMULATION) to compare with measured curve (TRACE A/B). It is viable to adjust value of each component parameter to get close to measured curve, or change equivalent circuit model to locate proper model that is most approximate to measured curve. Also, it's available to choose equivalent circuit model followed by directly inputting value of each component parameter to generate simulated curve (TRACE A/B SIMULATION) to further compare with measured curve (TRACE A/B). The parameters of both resonance frequency (SRF) and quality factor (Q_m) can be displayed simultaneously.

Application: capacitor, inductor, resistor, piezoelectric device and quartz crystal.

Parameter Description:

- SRF Fp (Self-Resonant Frequency, Frequency Parallel) is the frequency of parallel resonance within characteristic curve.
- SRF Fs (Self-Resonant Frequency, Frequency Serial) is the frequency of series resonance.
- Fp-Fs is the frequency difference between parallel resonance and series resonance within characteristic curve.
- $Q_m \text{ inf}$ indicates Q_m is infinity, which shows in incalculable situation, e.g., zero value.

Inductor: Select A, B and F models for Inductor characterization and there is one resonance (Fp).

Select FREQUENCY for TYPE and LOG for X-AXIS.

TRACE A: Set Z for parameter setting and LOG for Y-AXIS.

TRACE B: Set Deg for parameter setting and LINEAR for Y-AXIS.

Quality Factor: $Q_m = \sqrt{(C1/L1)} * R_p$ (R_p indicates R1 of Type A)

Model A: With covering curve of resonance, it is to perform precise analysis on characterization in proximity of resonance without the element of on resistance.

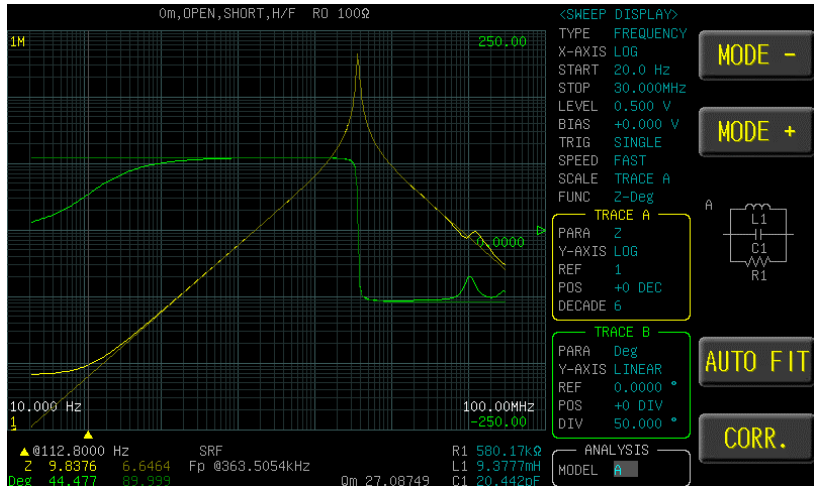

Figure: Model A

Model B: With covering curve of resonance, it is to perform analysis on both low frequency and on resistance with skipping the high-frequency loss.

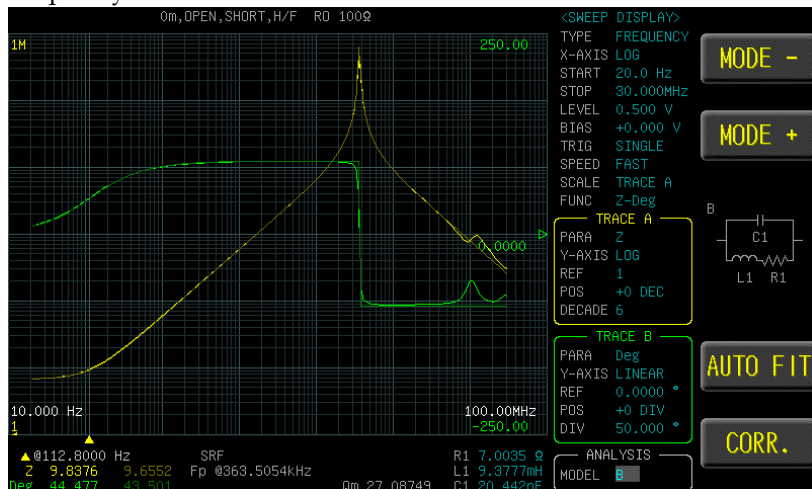

Figure: Model B

Model F: With covering curve of resonance and merits of A, B models in mergance, it is to select F model for analysis in terms of general inductor, which fits real characteristic properly.

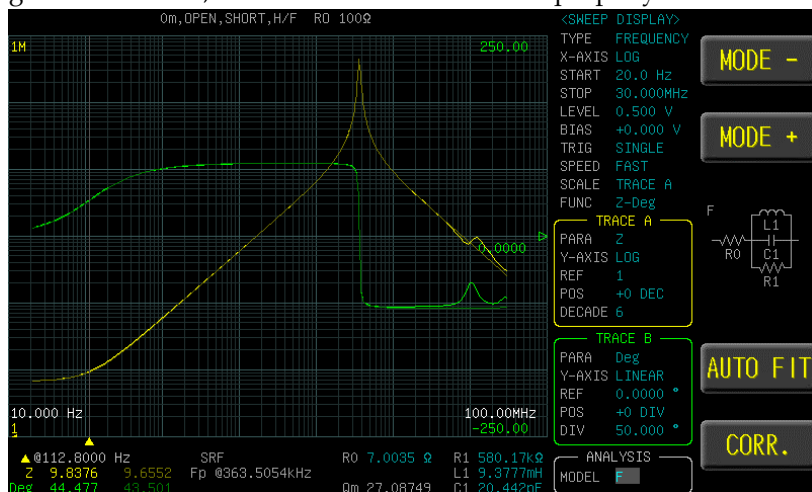

Figure: Model F

Capacitor: Select C, D and G models for Capacitor characterization and there is one resonance (Fp).

Select FREQUENCY for TYPE and LOG for X-AXIS.

TRACE A: Set Z for parameter setting and LOG for Y-AXIS.

TRACE B: Set Deg for parameter setting and LINEAR for Y-AXIS.

Quality Factor: $Q_m = \sqrt{L1/C1} / R_s$ (R_p indicates $R1$ of Type D)

Model C: With covering curve of resonance, it is to perform analysis on both low frequency and insulation loss with skipping the element of ESR.

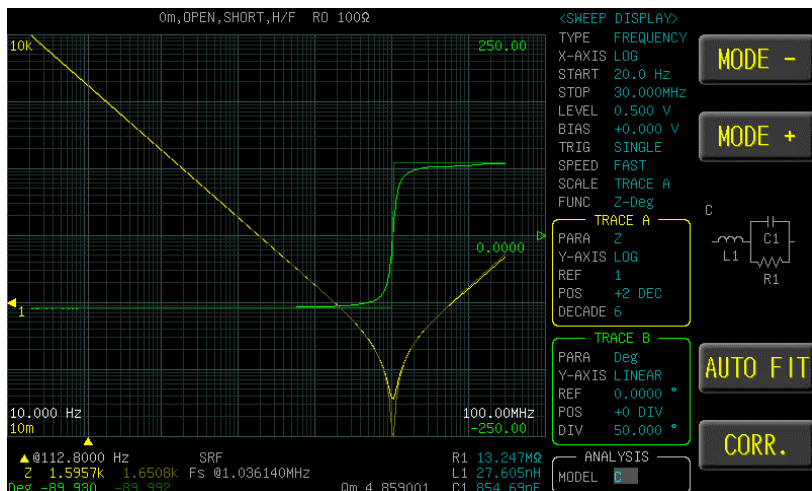

Figure: Model C

Model D: With covering curve of resonance, it is to perform precise analysis on characterization in proximity of resonance with skipping the element of insulation loss.

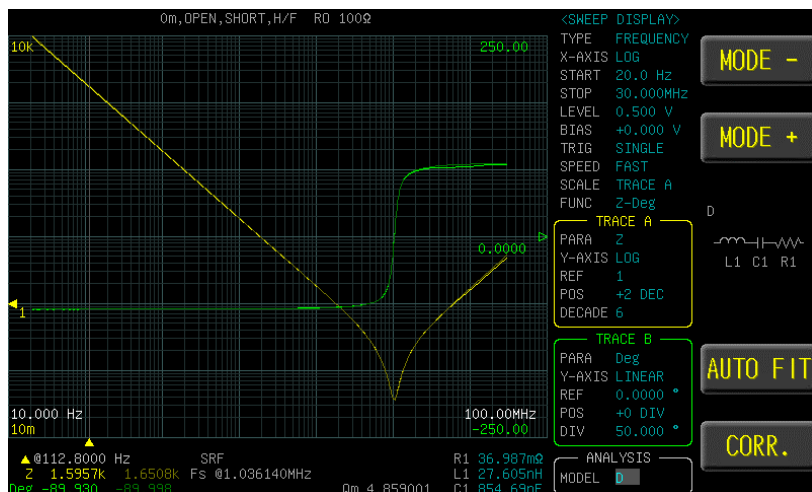

Figure: Model D

Model G: With covering curve of resonance and merits of C, D models in mergance, it is to select G model for analysis in terms of general capacitor, which fits real characteristic properly.

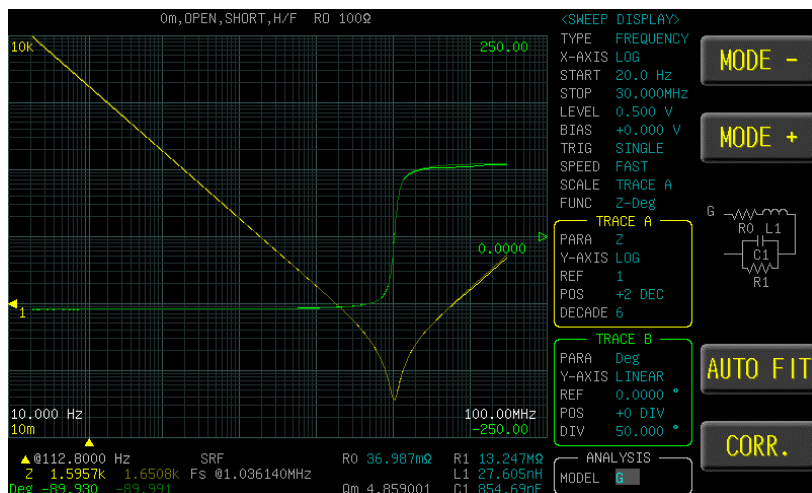

Figure: Model G

Piezoelectric Device and Quartz Crystal: Select E model for Piezoelectric Device and Quartz Crystal characterization and there are two resonances (Fs and Fp).

Select FREQUENCY for TYPE and LINNEAR for X-AXIS.

TRACE A: Set Z for parameter setting and LOG for Y-AXIS.

TRACE B: Set Deg for parameter setting and LINEAR for Y-AXIS.

Type E: quality factor $Q_m = \sqrt{L1/C1} / R1$

Model E: With covering 2 resonances within measured curve, it is to set start and stop frequency, respectively, in terms of frequency of quartz crystal.

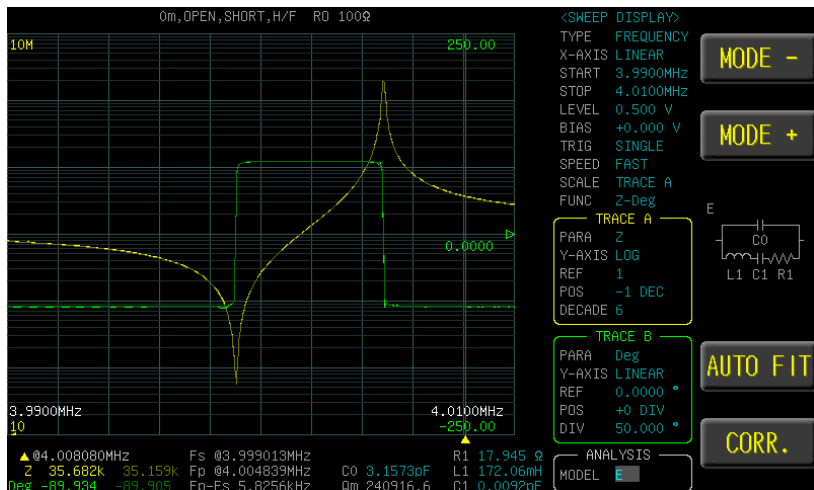

Figure: Model E

Resistor: Select B and C models for Resistor characterization. There is no resonance in resistor and this it is required to set parameters manually.

Select FREQUENCY for TYPE and LOG for X-AXIS.

TRACE A: Set Z for parameter setting and LOG for Y-AXIS.

TRACE B: Set Deg for parameter setting and LINEAR for Y-AXIS.

First measure resistance (Z) by METER MODE to realize if resistor is low-resistance or high resistance type in order to select model which is fitting for analysis. When resistance is less than 100Ω, which belongs to low resistance, it is suggested to adopt the model B. On the other hand, when resistance is greater than 100Ω, which belongs to high resistance, it is recommended to adopt the model C. However, if resistance is within the range from 100Ω to 10KΩ, try either the B model or the C model is suitable one.

Model B: Manually set parameters before measurement. It is suggested to set zero for capacitor since it has less influence in measurement. First input measurement resistance (Z) for R1, and 0.00F for C1. Input 20nH for L1 to adjust L1 in order to have simulated curve further close to measured curve.

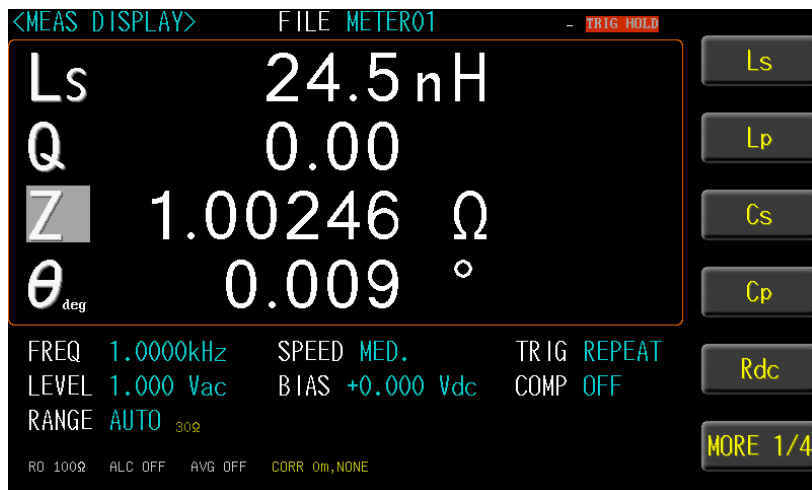

Figure: Value of Z

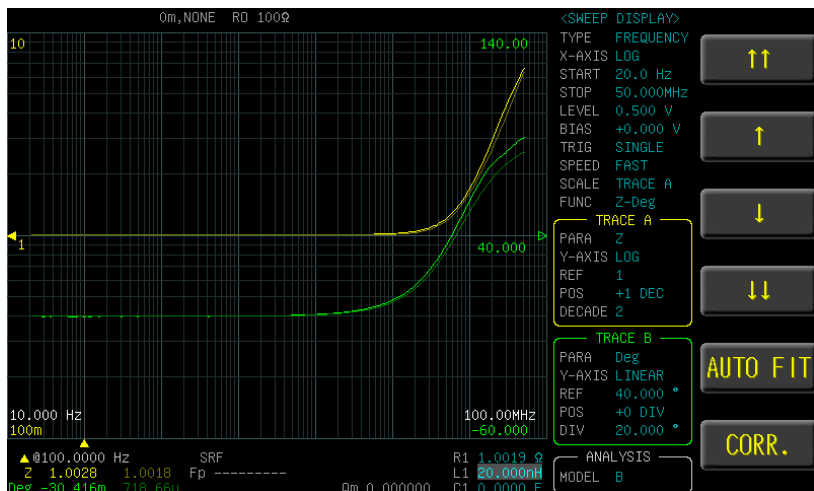

Figure: Model B

Model C: Manually set parameters before measurement. It is suggested to set zero for inductor since it has less influence in measurement. First input measurement resistance (Z) for R1, and 0.00H for L1. Input 0.228pF for C1 to adjust C1 in order to have simulated curve further close to measured curve.

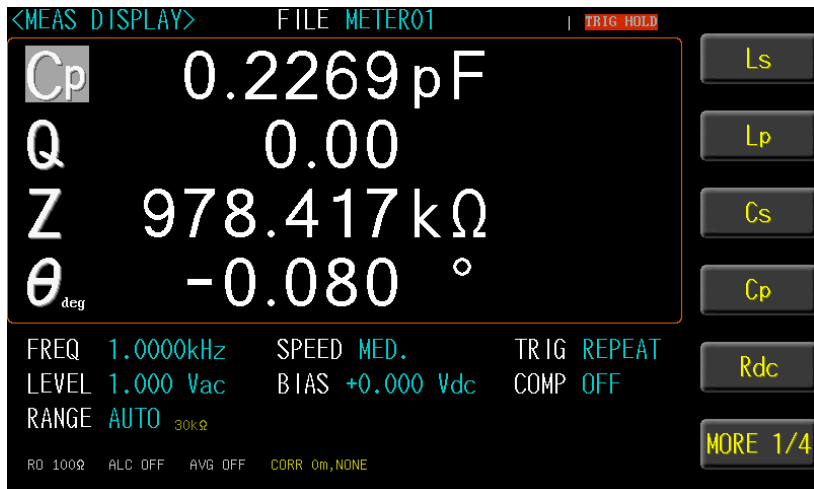

Figure: Value of Z

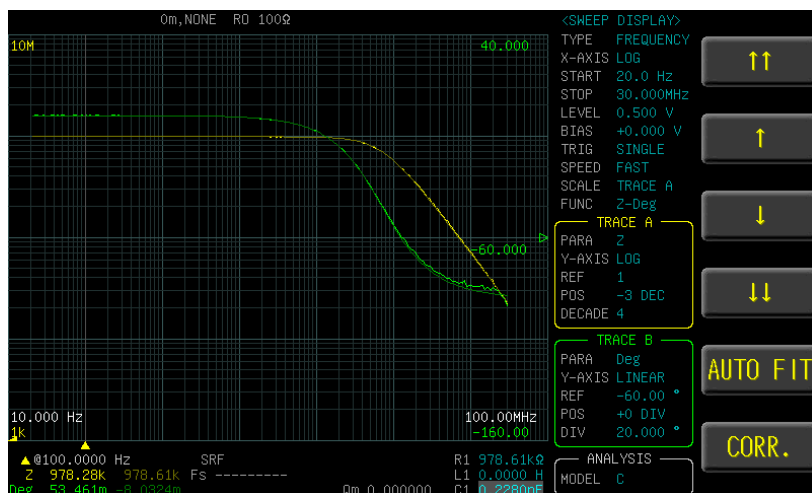
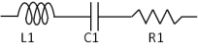
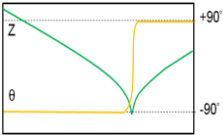
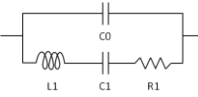
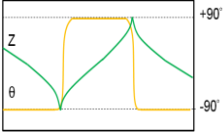
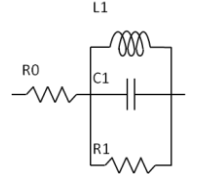
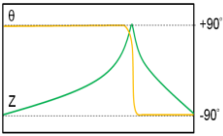
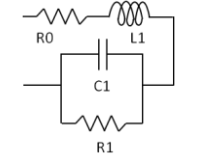
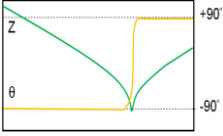

Figure: Model C

	Equivalent Circuit Model	Typical Frequency Characteristics	DUT Example
A			Inductor: Inductor with high core loss and low ESR
B			Inductor: Inductor with comparatively high ESR Resistor: Resistor with low resistance value and significant wiring inductance effect
C			Capacitor: Capacitor with significant leak resistance effect Resistor: Resistor with high resistance value and significant stray capacitance effect

<p>D</p>			<p>Capacitor: Typical capacitor</p>
<p>E</p>			<p>Piezoelectric element and Resonator</p>
<p>F</p>			<p>Inductor with high ESR</p>
<p>G</p>			<p>Capacitor with high ESR</p>

*Typical frequency characteristics graphs

For models A, B, C, D, F and G, the horizontal axis is logarithmic, the vertical axis (Z) is logarithmic, and θ is linear.

For model E, the horizontal axis is linear or logarithmic, the vertical axis (Z) is logarithmic and θ is linear.