

# SAFETY TERMS AND SYMBOLS

These terms may appear in this manual or on the product:



**WARNING.** Warning statements identify condition or practices that could result in injury or loss of life.



**CAUTION.** Caution statements identify conditions or practice that could result in damage to this product or other property.



**WARNING:** This equipment is not for measurements performed for CAT II, III and IV.

**Measurement category I** is for measurements performed on circuits not directly connected to MAINS.

**Measurement category II** is for measurements performed on circuits directly connected to the low voltage installation.

**Measurement category III** is for measurements performed in the building installation.

**Measurement category IV** is for measurements performed at the source of the low-voltage installation.

The following symbols may appear in this manual or on the product:



**DANGER**  
High Voltage



**DANGER**  
Hot Surface



**ATTENTION**  
refer to Manual



**Protective**  
**Conductor**  
**Terminal**



**Earth(ground)**  
**terminal**

## FOR UNITED KINGDOM ONLY

### NOTE

**This lead/appliance must only be wired by competent persons**

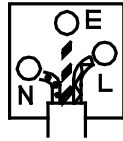
### WARNING

**THIS APPLIANCE MUST BE EARTHED**


### IMPORTANT

**The wires in this lead are coloured in accordance with the following code:**

**Green/  
Yellow: Earth  
Blue : Neutral  
Brown: Live  
(Phase)**



As the colours of the wires in main leads may not correspond with the colours marking identified in your plug/appliance, proceed as follows:

The wire which is coloured Green & Yellow must be connected to the Earth terminal marked with the letter E or by the earth symbol  or coloured Green or Green & Yellow.

The wire which is coloured Blue must be connected to the terminal which is marked with the Letter N or coloured Blue or Black.

The wire which is coloured Brown must be connected to the terminal marked with the letter or P or coloured Brown or Red.

If in doubt, consult the instructions provided with the equipment or contact the supplier.

This cable/appliance should be protected by a suitably rated and approved HBC mains fuse; refer to the rating information on the equipment and/or user instructions for details. As a guide, cable of 0.75mm<sup>2</sup> should be protected by a 3A or 5A fuse. Larger conductors would normally require 13A types, depending on the connection method used.

Any moulded mains connector that requires removal/replacement must be destroyed by removal of any fuse & fuse carrier and disposed of immediately, as a plug with bared wires is hazardous if engaged in a live socket. Any re-wiring must be carried out in accordance with the information detailed on this label.

## EC Declaration of Conformity

**We**

**GOOD WILL INSTRUMENT CO.,LTD.**

**No. 7-1, Jhongsing Rd., Tucheng City, Taipei County 236, Taiwan**

**GOOD WILL INSTRUMENT (SUZHOU) CO., LTD.**

**No.69 Lushan Road, Suzhou New District Jiangsu, China.**

declare, that the below mentioned products

**SPS-1230, SPS-1820, SPS-3610, SPS-2415, SPS-606**

are herewith confirmed to comply with the requirements set out in the Council Directive on the Approximation of the Law of Member States relating to Electromagnetic Compatibility (89/336/EEC, 92/31/EEC, 93/68/EEC) and Low Voltage Equipment Directive (73/23/EEC, 93/68/EEC).

For the evaluation regarding the Electromagnetic Compatibility and Low Voltage Equipment Directive, the following standards were applied:

<b>EN 61326-1: Electrical equipment for measurement, control and laboratory use — EMC requirements (1997+A1: 1998+A2:2001)</b>			
Conducted Emission	EN 55011:1998 Class A	Electrostatic Discharge	EN 61000-4-2:1995+A1:1998
Radiated Emission		Radiated Immunity	EN 61000-4-3:1996+A1:1998
Current Harmonic	EN61000-3-2: 2000	Electrical Fast Transients	EN 61000-4-4:1995
Voltage Fluctuation	EN61000-3-3:1995	Surge Immunity	EN 61000-4-5:1995
-----	-----	Conducted Susceptibility	EN 61000-4-6:1996
-----	-----	Power Frequency Magnetic field	EN 61000-4-8:1993
-----	-----	Voltage Dip/Interruption	EN 61000-4-11:1994

<b>Low Voltage Equipment Directive 73/23/EEC &amp; amended by 93/68/EEC</b>	
Low Voltage Directive	IEC/ EN 61010-1: 2001

# CONTENTS

<b>1. INTRODUCTION</b> .....	<b>1</b>
<b>2. SPECIFICATION</b> .....	<b>2</b>
<u>2-1. GENERAL</u> .....	2
<u>2-3. CONSTANT CURRENT OPERATION</u> .....	3
<u>2-4. INDICATOR METER</u> .....	3
<u>2-5. OVER VOLTAGE PROTECTION</u> .....	3
<u>2-6. INSULATION</u> .....	3
<b>3. PRECAUTIONS BEFORE OPERATION</b> .....	<b>4</b>
<u>3.1 UNPACKING THE SWITCHING POWER SUPPLY</u> .....	4
<u>3.2 CHECKING THE LINE VOLTAGE</u> .....	4
<u>3.3 ENVIRONMENT</u> .....	5
<u>3.4 EQUIPMENT INSTALLATION, AND OPERATION</u> .....	5
<b>4. THEORY OF OPERATION (SEE FIGURE 4-1)</b> .....	<b>6</b>
<b>5. PANEL CONTROLS AND INDICATORS</b> .....	<b>9</b>
<u>5-1. FRONT PANEL</u> .....	9
<u>5-2. REAR PANEL</u> .....	9
<b>6. OPERATION INSTRUCTIONS</b> .....	<b>12</b>
<u>6-1. PRECAUTION</u> .....	12
<u>6-2. SETTING CURRENT LIMIT</u> .....	15
<u>6-3. CONSTANT VOLTAGE / CONSTANT CURRENT CROSSOVER CHARACTERISTIC</u> .....	15
<u>6-4. OPERATION MODE: VOLTAGE OPERATION MODE</u> .....	16
<u>6-5. REMOTE ERROR SENSING</u> .....	16
<u>6-6. REMOTE CONTROL</u> .....	18
<u>6-7. OVP SETTING</u> .....	18
<b>7. MAINTENANCE</b> .....	<b>19</b>
<u>7-1. FUSE REPLACEMENT</u> .....	19
<u>7-2. LINE VOLTAGE CONVERSION</u> .....	19
<u>7-3. INTERNAL ADJUSTMENTS</u> .....	20
<u>7-4 CLEANING</u> .....	22

# 1. INTRODUCTION

The series of switching power supplies for measuring instrument have ruled out the inconvenience of big volume and heavyweight of a traditional power supply possess.

The output voltage and current is controlled by two variable resistors with coarse and fine regulation for more handy and precise adjustment.

## Features:

- With more extensive range of input voltage at 97V~133V (for 115V) and 195V~265V (for 230V).
- With high frequency operation can reduce the size of power transformer.
- With small size, light weight and high density power.
- Entire efficiency rate higher up to 70%.
- Auto control the voltage and current mode.
- Zero adjustment for the output of voltage and current.

## 2. SPECIFICATION

### 2-1. General

Main supply : 115V/230V±15% 50/60Hz (Switch selectable).

Rating, dimension and weight : See Table 2-1.

Table 2-1

Model	MAX. RATING		INPUT RATING		FUSE STYLE & RATING		WEIGHT
	Voltage	Current	Watts	VA	115V	230V	kg
SPS-1230	12V	30A	500	900	T 10A 250V	T 6.3A 250V	3.3
SPS-1820	18V	20A					
SPS-2415	24V	15A					
SPS-3610	36V	10A					
SPS-606	60V	6A					
Dimensions : 128(W) × 145(H) × 285(D) mm.							



**WARNING: Voltage over 60V DC is a lethal shock hazard to the user. Be careful when connecting power supplies in series to achieve voltage higher than 60V DC totally or 60V DC between any connection and earth ground.**

Operation Environment : Indoor use,  
Altitude up to 2000m,  
Installation Category II,  
Pollution degree 2.

Operation Temperature & Humidity : 0°C to 40°C, <80%.

Storage Temperature & Humidity : -10°C to 70°C, <70%.

Accessories : Test Lead (current < 4A)..... × 1  
Operation Manual..... × 1

## 2-2. Constant Voltage Operation

- (1) Output Voltage ranges from 0 to rating voltage with continuous adjustment.
- (2) Voltage regulation  
line regulation  $\leq 5\text{mV}$ .  
load regulation  $\leq 5\text{mV}$ .
- (3) Recovery time  $\leq 500 \mu\text{s}$  (50% Load change, minimum load 0.5A).
- (4) Ripple & Noise  $\leq 5\text{mV}_{\text{rms}}$ ,  $100\text{mV}_{\text{p-p}}$  (tested by 20MHz oscilloscope.)
- (5) Temperature coefficient  $\leq 100\text{ppm}/^\circ\text{C}$ .

## 2-3. Constant Current Operation

- (1) Output current ranges from 0 to rating current with continuous adjustment.
- (2) Current regulation  
line regulation  $\leq 3\text{mA}$ .  
load regulation  $\leq 3\text{mA}$ .

- (3) Ripple & Noise

SPS-606	SPS-3610	SPS-2415	SPS-1820	SPS-1230
$\leq 3\text{mArms}$	$\leq 5\text{mArms}$	$\leq 10\text{mArms}$	$\leq 10\text{mArms}$	$\leq 30\text{mArms}$

## 2-4. Indicator Meter

- 1)Voltage:  
Display : 3 1/2 Digits 0.39" Green LED display.  
Accuracy :  $\pm(0.5\%$  of rdg + 2 digits).
- 2)Current:  
Display : 3 1/2 Digits 0.39" Red LED display.  
Accuracy :  $\pm(0.5\%$  of rdg + 2 digits).

## 2-5. Over Voltage Protection

- (1) Over Voltage Protection ranges from 5% rating to rating +5.5%.
- (2) OVP Accuracy  $\pm(\text{Vset } 1\%+0.6\text{V})$

## 2-6. Insulation

- Between Chassis and Output Terminal :  $\geq 20\text{M}\Omega$  (DC500V).  
Between Chassis and AC Cord :  $\geq 30\text{M}\Omega$  (DC500V).

### 3. PRECAUTIONS BEFORE OPERATION

#### 3.1 Unpacking the Switching Power Supply

The instrument has been fully inspected and tested before shipping from the factory. Upon receiving the instrument, please unpack and inspect it to check if there is any damages caused during transportation. If any sign of damage is found, notify the bearer and/or the dealer immediately.

#### 3.2 Checking the Line Voltage

The instrument can be used with line voltages shown in the table below. Before connecting the power plug to an AC line outlet, make sure the voltage selector of the rear panel is set to the correct position and the proper fuse installed corresponding to the line voltage. The unit may be damaged if connected to the wrong AC line voltage.



**WARNING: To avoid electrical shock the power cord protective grounding conductor must be connected to ground.**

When line voltages are changed, replace the required fuses shown below.

Line voltage	Range	Fuse	Line voltage	Range	Fuse
115V	97-133V	T 10A 250V	230V	195-250V	T 6.3A 250V



**WARNING: To avoid personal injury, disconnect the power cord before removing the fuse holder.**



### 3.3 Environment

The normal ambient temperature range of this instrument is from 0° to 40°C (32° to 104°F). Operation of the instrument above this temperature range may cause damage to the circuits.

Do not use the instrument in a place where strong magnetic or electric field exists as it may disturb the measurement.

### 3.4 Equipment Installation, and Operation

Ensure there is proper ventilation for the vents in the SPS power supplies case. If this equipment is used in a manner not according to the specification, the protection provided by the equipment may be impaired.



**WARNING: This is a Class A product. In a domestic environment this product may cause radio interference in which case the user may be required to take adequate measures.**



**WARNING: This equipment is not for measurements performed for CAT II, III and IV.**

#### 4. THEORY OF OPERATION (See Figure 4-1)

- **Block Configuration of SPS- System**

The SPS-Series comprise a Bridge rectifier, a Pulse Width Modulation, a Driver Circuit, a Driver Transformer, a Rectifier Circuit, a Voltage Control Circuit, a Current Shunt, an Output Filter, a Voltage/Current Adjusting Circuit, a Buffer Circuit, an Error Amplifier, an Opto-Isolator, and an Auxiliary Switching Supply and etc.

- **Component List for each circuit configuration**

Bridge Rectifier:	BD101.
Pulse Width Modulation:	U102.
Driver Circuit:	T104, Q105~Q108.
Driver Transformer:	T301.
Rectifier Circuit:	D301,D3011.
Voltage Control Circuit:	Q303.
Current Shunt:	R341.
Output Filter:	Common Choke L302, C325.
Voltage/Current Adjusting Circuit:	U302.
Buffer Circuit:	U302, Q301.
Error Amplifier:	U301, U303.
Opto-isolator:	U304.
Auxiliary Switching Supply:	U201, U202, T201.
OVP:	U401, U402
Remote Control:	RL401, D402

## ● Description of Circuit Theory

### 1) +10V Voltage reference circuit :

Start up the circuits of R306 and D302 to ensure the output voltage of OPA U301, PIN 1 is in positive status when power is on. At this moment, the output voltage of PIN 1 will pass through R307 to maintain the voltage of both ends of ZENER DIODE ZD301(6.2V) to 6.2V. As OPA has the character of false short circuit, so U301 PIN3=6.2V, refer to the

$$V_{ref} = 6.2 \frac{VR301 + R304 + R305}{R305} = 6.2 \frac{VR301 + 4.99k + 10k}{10k} \cong 10V$$

following formula:

Therefore, the OPA's output voltage can be changed by adjusting the VR301 as shown in the following formula:

$$V_{ref}=10V \rightarrow VR301=1.14k\Omega$$

### 2) Voltage Adjusting Circuit

The R311, and R313 are voltage feedback attenuating resistors while R312 is to control the output of Reference voltage. Please refer to the following formula:

$$V_{out} = V_{ref} \frac{R311 + R313}{R313}$$

If  $V_{ref}=10V$   $R311=52.3k\Omega$   $R313=20k\Omega$

$$V_{out} = V_{ref} \frac{52.3k + 20k}{20k} = 10 \frac{72.3k}{20k} = 36.15V$$

And the R316, R317, C313, C314, and C315 are compensated circuits for voltage frequency.

### 3) Current Adjusting Circuit:

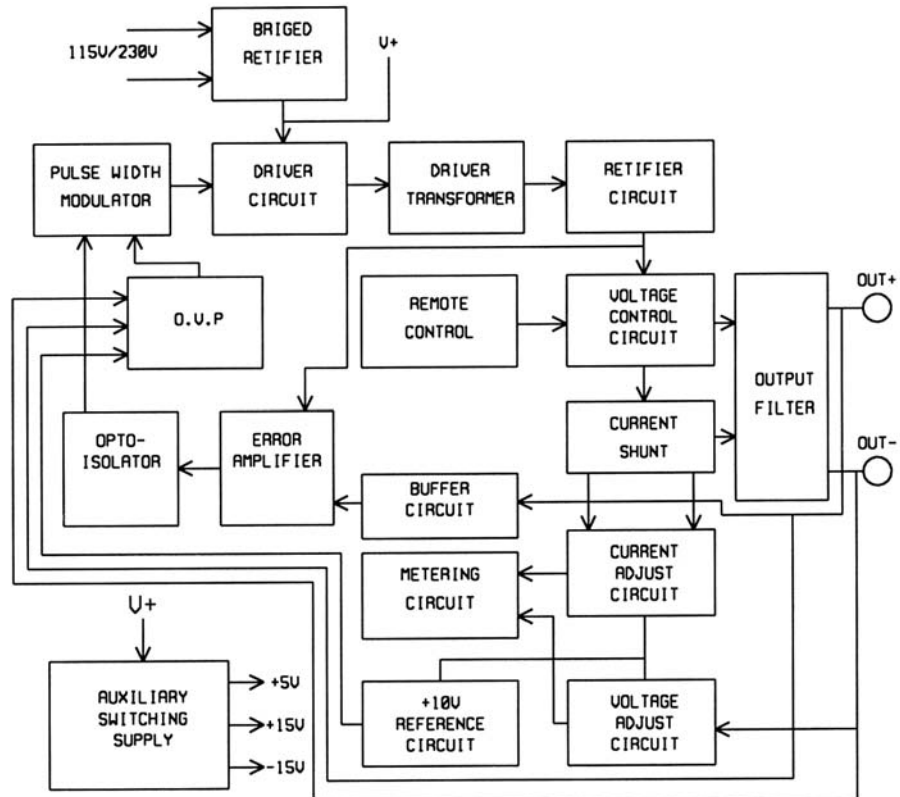
The U302 is an Error Amplifier with the gain at:  $A = \frac{R326}{R342} = \frac{100k}{3.57k} = 28.01$

$$I_o \times R341 \times A = 10V \times \frac{R321}{R321 + R322 + VR303} = V_{pin12} = V_{pin13}$$

For example: SPS-1820,  $I_o=20A$  ,  $R341=10m\Omega$

$$V_{pin12}=I_o \times R341 \times A=20 \times 0.01 \times 28.01=5.602V$$

● Figure 4-1: Block Diagram



## 5. PANEL CONTROLS AND INDICATORS

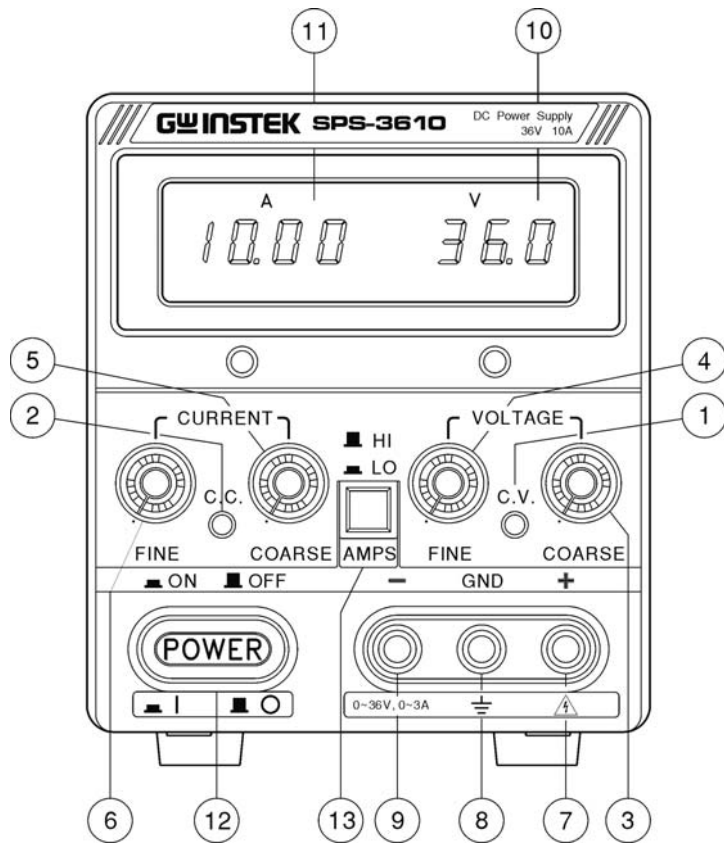
### 5-1. Front panel

- |      |                       |   |
|------|-----------------------|---|
| (1)  | CV Indicator          | Lights when the power is on and in constant voltage operation.  |
| (2)  | CC Indicator          | Lights when in constant current operation.  |
| (3)  | Voltage coarse        | For the coarse adjustment of the output voltage.  |
| (4)  | Voltage fine          | For the fine adjustment of the output voltage.  |
| (5)  | Current coarse        | For the coarse adjustment of the output current.  |
| (6)  | Current fine          | For the fine adjustment of the output current.  |
| (7)  | “+” output terminal   | Positive polarity (Red) (MAX. 3A output only).  |
| (8)  | “GND” terminal        | Earth and chassis ground (Green).   |
| (9)  | “ - “output terminal  | Negative polarity (Black) (MAX. 3A output only).  |
| (10) | Meter                 | Indicates the output voltage.   |
| (11) | Meter                 | Indicates the output current.   |
| (12) | Power control         | On/Off switch.  |
| (13) | Current HI/LO control | Current indicates HI/LO range selection.<br>HI range: Output current range is from 0 to rating current.<br>LO range: Output current range is from 0 to half-rating current. |

### 5-2. Rear panel

- |      |                   |  |
|------|-------------------|--|
| (14) | Fuse holder       |  |
| (15) | Power socket.     |  |
| (16) | AC selects switch | With 115V or 230V voltage and current ranges selection (Refer to the diagrammatic instruction to prevent mis-operating). |
| (17) | Fan               | Cooling fan.   |
| (18) | S+ sense terminal | A positive input voltage remote sense terminal.  |
| (19) | S- sense terminal | A negative input voltage remote sense terminal.  |
| (20) | + output terminal | Screw type + output terminal.  |
| (21) | - output terminal | Screw type - output terminal.  |
| (22) | Ground terminal   | Screw type ground terminal (connected to case chassis).  |
| (23) | Remote Control    | Short or open the remote control terminal for output on or off.  |
| (24) | OVP ADJ           | Adjust trimmer VR401 to set the OVP value.   |
| (25) | M+ sense terminal | A positive output voltage monitor terminal.  |
| (26) | M- sense terminal | A negative output voltage monitor terminal.  |

Remark: As the front panel has 3A current limit and no remote sense terminal, it is recommended to use rear output terminal for most of the applications.



**Fig. 5-1 Front Panel**

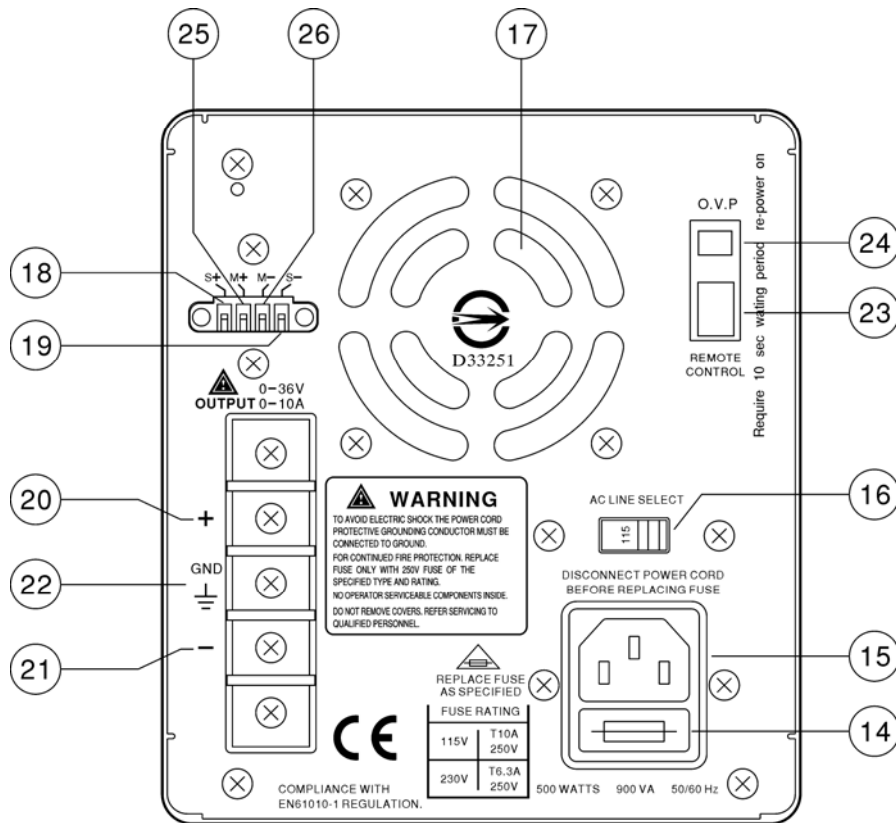


Fig. 5-2 Rear Panel

## 6. OPERATION INSTRUCTIONS

### 6-1. Precaution

#### (1) AC input

AC input should be within the range of line voltage  $\pm 15\%$  50/60Hz.



**WARNING:** To avoid electrical shock, the power cord protective grounding conductor must be connected to ground.

#### (2) Installation

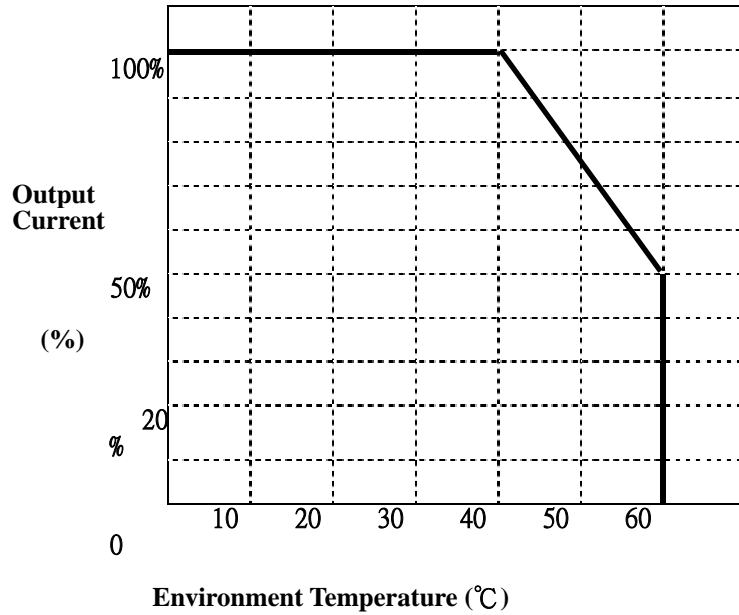
Avoid using the power supply in a place where ambient temperature exceeds 40°C. The heat sink located at rear of the power supply must have sufficient space for radiation.



**CAUTION:** To prevent the instrument from damage, ensure the working environment is under 40°C of temperature. If exceeding 40°C, please refer to the drawing shown as (3) of next page.



**(3) Output Current/Temperature Cure Line Chart:**



#### (4) Output Test lead Selection:

The Selection of Output Test Lead and Feedback Test Lead:

For safety assurance, please select the adequate output test lead according to the following list:

UL (CSA) Model	Conductor				Maximum Conductive Resistor $\Omega/\text{km}$	Permissible Current A(amp)
	Wire No. AWG	Component pc/mm	Cross Section Area (mm) <sup>2</sup>	Outer Diameter mm		
1015 TEW (Twisted Wire)	24	11/0.16	0.22	0.64	88.6	7.64
	22	17/0.16	0.34	0.78	62.5	10.0
	20	21/0.18	0.53	0.95	39.5	13.1
	18	34/0.18	0.87	1.21	24.4	17.2
	16	26/0.254	1.32	1.53	15.6	22.6
	14	41/0.254	2.08	2.03	9.90	30.4
	12	65/0.254	3.29	2.35	6.24	40.6
	10	65/0.32	5.23	3.00	3.90	55.3

Remark:

1. The ambient temperature of “Permissible Current” is at 40°C, the withstanding temperature of conductor is at 105 °C according to the condition of the distributed single wire.
2. The permissible current listed as above is suggested to be used under 70%.
3. If the feedback test leads are in need, the level above UL(CSA) AWG24, 22, 20... can be accepted. Besides, when the load is a capacitive load, please use the twine wire by twisting (+)output test lead with (S+) feedback test lead. Same way used on (-) output test lead and (S-) feedback test lead.
4. When the current value exceeds above suggestive list, can select more wires used in parallel according to above list.

## 6-2. Setting Current Limit

- (1) Determine the maximum safe current for the device to be powered.
- (2) Temporarily short the (+) and (-) terminals of the power supply together with a test lead.
- (3) Rotate the COARSE VOLTAGE control away from zero sufficiently to have the CC indicator lightened.
- (4) Adjust the CURRENT control for the desired current limit. Read the current value on the Ammeter.
- (5) The current limit (overload protection) has now been preset. Do not change the CURRENT control setting after this step.
- (6) Remove the short between the (+) and (-) terminals and hook up for constant voltage operation.

## 6-3. Constant Voltage / Constant Current Crossover Characteristic

The working characteristic of this series is called a constant voltage/constant current automatic crossover type. This permits continuous transition from constant current to constant voltage modes in response to the load change. The intersection of constant voltage and constant current modes is called the crossover point. Fig.6-1 shows the relationship between this crossover point and the load.

For example, if the load is such that the power supply is operating in the constant voltage mode, a regulated output voltage is provided. The output voltage remains constant as the load increases, up until the point where the preset current limit is reached. At that point, the output current becomes constant and the output voltage drop is proportioned to further increases in load. The crossover point is indicated by the front panel LED indicators. The crossover point is reached when the CV indicator goes out and the CC indicator is on.

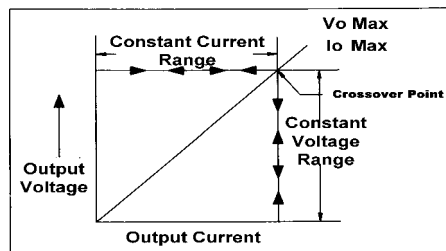


Fig. 6-1 Constant Voltage/Constant Current Characteristic.

Similarly, crossover from the constant current to the constant voltage mode automatically occurs from a decrease in load, a good example of this would be seen when charging a 12 volt battery. Initially, the open circuit voltage of the power supply may be preset for 13.8 volts. A low battery will place a heavy load on the supply and it will operate in the constant current mode, which may be adjusted for a 1 amp charging rate. As the battery becomes charged, and its voltage approaches 13.8 volts, its load decreases to the point where it no longer demands the full 1 amp charging rate. This is the crossover point where the power supply goes into the constant voltage mode.

#### 6-4. Operation mode: Voltage Operation Mode

- A. Set Power switch to “OFF” position.
- B. Make sure that line voltage is correct for the input power voltage.
- C. Plug power cord into the power outlet.
- D. Set Power switch to “ON” position.
- E. Adjust “Voltage” and “Current” control to the desired output voltage and current.
- F. Connect the external load to the output binding posts. Make sure both “+” and “-” terminals are connected correctly.

#### 6-5. Remote Error Sensing

A normal power supply can perform its best load regulation, line regulation, low output impedance, and low output ripple and noise, as well as the rapidly transient recovery response. Please refer to figure 6-2. If there is any test lead connected between load and output terminal, the best characters of power supply can not be shown up on the load terminal.

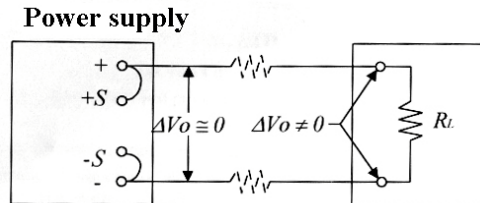
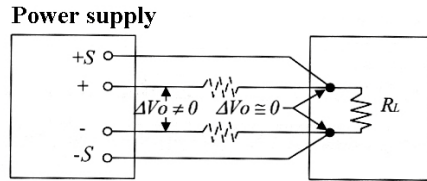


Figure 6-2 The power supply with local error sensing

The function of the Remote Error Sensing can only be applied to the Constant Voltage mode as shown in Figure 6-3. The feedback point of power supply must start from the load terminal directly. Therefore, the power supply can display its function on the load terminal instead of output terminal. To compensate the voltage drop causing from the test lead, it needs to shift the voltage from the output terminal of power supply, and the voltage on the load terminal remains unchanged. A large test lead is recommended in order to reduce the voltage drop as less as better on the test lead (typical 0.5V maximum).

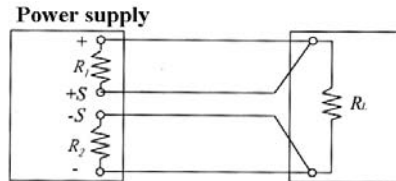
**Never use the Sense connections without connecting the normal large test lead to output terminal.**



**Figure 6-3 The power supply with remote error sensing**

### Error Sensing Open Protection

The sensing circuit must avoid open circuit without equipping with Relay, Switch, and Connector. When the open circuit is occurred abruptly on the sensing circuit, it will cause overshoot on the output terminal. To prevent this kind of phenomenon, add small resistance  $R_1$  and  $R_2$  or replace with diode as shown in the Figure 6-4.



**Figure 6-4 The power supply with remote error sensing protection**

## **6-6. Remote Control**

Short the Remote Control terminal for output ON, and open the Remote Control terminal for output OFF.

## **6-7. OVP Setting**

Firstly, adjust the OVP ADJ knob clockwise to the maximum OVP, then adjust output voltage to reach the voltage of OVP. Secondly, adjust the OVP ADJ knob counter-clockwise slowly until the OVP message appears. Then the setting value of OVP is slightly less than the OVP which you intend to set.

## 7. MAINTENANCE

### WARNING

The following instructions are used by qualified personnel only. To avoid electrical shock, do not perform any servicing other than the operating instructions of the manual unless you are qualified to do so.

#### 7-1. Fuse Replacement

If the fuse blown, the CV or CC indicators will not light and the power supply will not operate. The fuse should not normally blow unless a problem has developed in the unit. Try to determine and correct cause of the blown fuse, then replace only with a fuse of the correct rating and type.

The fuse is located on the rear panel (see Fig. 5-2).



**WARNING: For continued fire protection. Replace with 250V fuse of the specified type and rating, and disconnect the power cord before replacing fuse.**

#### 7-2. Line Voltage conversion

The primary winding of the power transformer is tapped to permit operation from 115/230 VAC, 50/60 Hz line voltage. Conversion from one line voltage to another is done by change AC selects switch as shown in Fig. 5-2.

To convert to different line voltage, perform the following procedure:

- (1) Make sure the power cord is unplugged.
- (2) Set the AC switch to the desired line voltage position.
- (3) The change of line voltage may also require a corresponding change of fuse value. Install correct fuse value according to the instruction shown on rear panel.

### 7-3. Internal adjustments

The unit was accurately adjusted at the factory before shipment. So, readjustment is suggested only when the accuracy of circuit is affected by the repair, or when you have the reason to believe that the unit is out of accuracy. The recommended calibration device is a multi-meter with an accuracy of  $\pm 0.1\%$  dcV or better. (GOOD WILL model GDM-8145 or equivalent).

If readjustment is required, proceed the following procedure. Locations of the adjustments are shown in Fig. 6-1 and Fig.7-2.

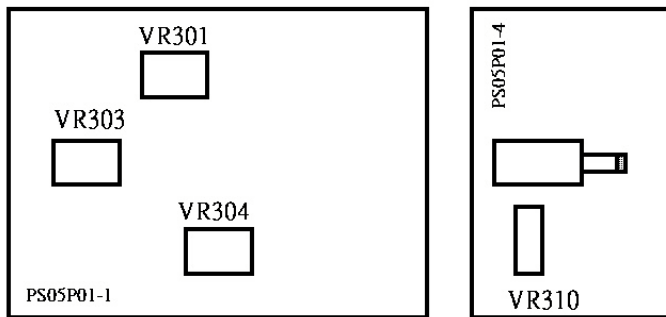
#### (1) Adjustment of the Rating Voltage

- A. Connect an accurate ( $\pm 0.1\%$ ) external multi-meter to measure the dc voltage at output terminals of the power supply.
- B. Set the COARSE and FINE VOLTAGE controls to maximum (fully clockwise).
- C. Adjust trimmer VR301 for a reading on the multi-meter to be 18.50V for SPS-1820, 36.50V for SPS-3610, and 60.50V for SPS-606, 24.5V for SPS-2415, 12.5V for SPS-1230.
- D. Adjust trimmer pot VR2 to set the reading value of voltmeter as same as the one shown on the multi-meter..

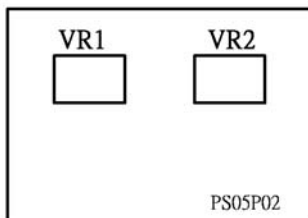
#### (2) Adjustment of the rating Current

- A. Set the CURRENT control to HI.
- B. Set the COARSE and FINE CURRENT controls to minimum (fully counterclockwise).
- C. Set the COARSE and FINE VOLTAGE controls to the center position.
- D. Connect an external multi-meter to measure dc current of output terminal.
- E. Adjust trimmer VR304 to have a reading of  $-0.00A$  indicated on the current meter.
- F. Set the COARSE and FINE CURRENT controls to maximum (fully clockwise)
- G. Adjust trimmer VR303 for a reading on the multi-meter to be 20.10A for SPS-1820, 10.10A for SPS-3610, and 6.10A for SPS-606, 15.1A for SPS-2415, 30.1A for SPS-1230.
- H. Adjust trimmer VR2 to set the reading value of Amp-meter as the same as the one shown on the multi-meter.
- I. Set CURRENT control to LOW.
- J. Adjust trimmer VR310 to set the reading value of Amp-meter as 0.5 times to the rating current.
- K. Adjust trimmer VR401 to set the OVP value (see Fig. 7-3).

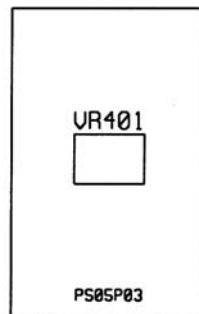




**Fig. 7-1 Adjustment Location**



**Fig. 7-2 Adjustment Location**



**Fig. 7-3 Adjustment Location**

#### **7-4 Cleaning**

To clean the power supply, use a soft cloth dampened in a solution of mild detergent and water. Do not spray cleaner directly onto the instrument, since it may leak into the cabinet and cause damage. Do not use chemicals containing benzene, benzene, toluene, xylem, acetone, or similar solvents. Do not use abrasive cleaners on any portion of the instrument.