

DC Power Supply

SPD-3606

USER MANUAL

GW INSTEK PART NO. 82PD-3606M0

This manual contains proprietary information, which is protected by copyrights. All rights are reserved. No part of this manual may be photocopied, reproduced or translated to another language without prior written consent of Good Will company.

The information in this manual was correct at the time of printing. However, Good Will continues to improve products and reserves the rights to change specification, equipment, and maintenance procedures at any time without notice.



ISO-9001 CERTIFIED MANUFACTURER

GW INSTEK

Good Will Instrument Co., Ltd.
No. 7-1, Jhongsing Rd., Tucheng City, Taipei County 236, Taiwan.

Table of Contents

SAFETY INSTRUCTION 5

OVERVIEW..... 9

- SPD-3606 Main Features 10
- Principle of Operation..... 11
- Front Panel Overview 14
- Rear Panel Overview 17
- CV/CC Crossover Characteristics 18

SETUP..... 19

- Installation Location 20
- Power Up 21
- Over Voltage Protection Setup 22
- Load Cable Connection 24
- Output On/Off..... 25

OPERATION..... 26

- CH1/CH2 Independent Mode 26
- CH3 Independent Mode..... 28
- CH1/CH2 Tracking Series Mode..... 30
- CH1/CH2 Tracking Parallel Mode 36

REMOTE OUTPUT CONTROL..... 39

PERFORMANCE VERIFICATION 40

- Output Voltage Verification 42
- Tracking Series Voltage Verification..... 45
- Output Current verification 47
- OVP verification..... 50
- Recording Tables 54

FAQ 56

APPENDIX 57

- Fuse Replacement 57
- Volume Guard (Optional)..... 58
- Specification 59
- Declaration of Conformity 61







INDEX..... 62

S SAFETY INSTRUCTION

This chapter contains important safety instructions that you must follow when operating SPD-3606 and when keeping it in storage. Read the following before any operation to insure your safety and to keep the best condition for SPD-3606.

Safety Symbols

These safety symbols may appear in this manual or on SPD-3606.

	WARNING	Warning: Identifies conditions or practices that could result in injury or loss of life.
	CAUTION	Caution: Identifies conditions or practices that could result in damage to SPD-3606 or to other properties.
	DANGER High Voltage	
	Attention Refer to the Manual	
	Protective Conductor Terminal	
	Earth (ground) Terminal	

Safety Guidelines

General Guideline • Do not place any heavy object on SPD-3606.



CAUTION

- Avoid severe impacts or rough handling that leads to damaging SPD-3606.
- Do not discharge static electricity to SPD-3606.
- Do not block or obstruct the cooling fan vent opening.
- Leave a space around SPD-3606, at least 3cm to the left and right.
- Do not perform measurement at circuits directly connected to Mains (Note below).
- Do not disassemble SPD-3606 unless you are qualified as service personnel.

(Measurement categories) EN 61010-1:2001 specifies the measurement categories and their requirements as follows. SPD-3606 falls under category I.

- Measurement category IV is for measurement performed at the source of low-voltage installation.
- Measurement category III is for measurement performed in the building installation.
- Measurement category II is for measurement performed on the circuits directly connected to the low voltage installation.
- Measurement category I is for measurements performed on circuits not directly connected to Mains.

Power Supply



WARNING

- AC Input voltage: 115V/230V $\pm 15\%$, 50/60Hz
- Connect the protective grounding conductor of the AC power cord to an earth ground, to avoid electrical shock.

Fuse



WARNING

- Fuse type: T10A/250V
- Make sure the correct type of fuse is installed before power up.

- To ensure fire protection, replace the fuse only with the specified type and rating.
- Disconnect the power cord before fuse replacement.
- Make sure the cause of fuse blowout is fixed before fuse replacement.

Cleaning SPD-3606

- Disconnect the power cord before cleaning.
- Use a soft cloth dampened in a solution of mild detergent and water. Do not spray any liquid.
- Do not use chemical or cleaner containing harsh material such as benzene, toluene, xylene, and acetone.

Operation Environment

- Location: Indoor, no direct sunlight, dust free, almost non-conductive pollution (Note below)
- Relative Humidity: < 80%
- Altitude: < 2000m
- Temperature: 0°C to 40°C

(Pollution Degree) EN 61010-1:2001 specifies the pollution degrees and their requirements as follows. SPD-3606 falls under degree 2.

Pollution refers to "addition of foreign matter, solid, liquid, or gaseous (ionized gases), that may produce a reduction of dielectric strength or surface resistivity".

- Pollution degree 1: No pollution or only dry, non-conductive pollution occurs. The pollution has no influence.
- Pollution degree 2: Normally only non-conductive pollution occurs. Occasionally, however, a temporary conductivity caused by condensation must be expected.
- Pollution degree 3: Conductive pollution occurs, or dry, non-conductive pollution occurs which becomes conductive due to condensation which is expected. In such conditions, equipment is normally protected against exposure to direct sunlight, precipitation, and full wind pressure, but neither temperature nor humidity is controlled.

Storage environment

- Location: Indoor
- Relative Humidity: < 70%
- Temperature: -10°C to 70°C

Power cord for the United Kingdom

When using SPD-3606 in the United Kingdom, make sure the power cord meets the following safety instructions.

NOTE: This lead/appliance must only be wired by competent persons

 **WARNING: THIS APPLIANCE MUST BE EARTHED**

IMPORTANT: The wires in this lead are coloured in accordance with the following code:

Green/ Yellow: Earth

Blue: Neutral

Brown: Live (Phase)



As the colours of the wires in main leads may not correspond with the colours marking identified in your plug/appliance, proceed as follows:

The wire which is coloured Green & Yellow must be connected to the Earth terminal marked with the letter E or by the earth symbol  or coloured Green or Green & Yellow.

The wire which is coloured Blue must be connected to the terminal which is marked with the letter N or coloured Blue or Black.

The wire which is coloured Brown must be connected to the terminal marked with the letter L or P or coloured Brown or Red.

If in doubt, consult the instructions provided with the equipment or contact the supplier.

This cable/appliance should be protected by a suitably rated and approved HBC mains fuse: refer to the rating information on the equipment and/or user instructions for details. As a guide, cable of 0.75mm² should be protected by a 3A or 5A fuse. Larger conductors would normally require 13A types, depending on the connection method used.

Any moulded mains connector that requires removal /replacement must be destroyed by removal of any fuse & fuse carrier and disposed of immediately, as a plug with bared wires is hazardous if engaged in live socket. Any re-wiring must be carried out in accordance with the information detailed on this label.

OVERVIEW

This chapter describes SPD-3606 in a nutshell, including its main features and front / rear panel introduction. After going through the overview, follow the Setup chapter (page19) to properly power up and set operation environment.

For initial inspection, refer to the Performance verification chapter (page40).

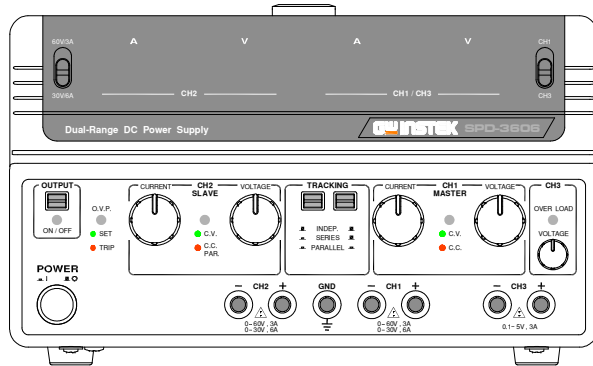

Main Feature	SPD-3606 Main Features	10
Theory	Principle of Operation	11
Panel overview	Front Panel Overview	14
	Rear Panel Overview.....	17
CV/CC	CV/CC Crossover Characteristics	18

SPD-3606 Main Features

- | | |
|-------------|---|
| Performance | <ul style="list-style-type: none"> • Low noise ($\leq 50\text{dB}$, Cooling fan controlled by Heatsink temperature) • High efficiency power conversion, minimum 70% with full load • Fast Output On/Off response ($\leq 100\text{ms}$) • Low temperature coefficient ($\leq 100\text{ppm}/^\circ\text{C}+3\text{mV}$, $\leq 150\text{ppm}/^\circ\text{C}+3\text{mA}$) • Compact size, light weight (6kg) |
| Operation | <ul style="list-style-type: none"> • Constant voltage operation • Constant current operation • Tracking Series operation • Tracking Parallel operation • Output On/Off control • 3 outputs with full Voltage control • Output range selection for CH1 and CH2, 60V/3A or 30V/6A • LED display |
| Protection | <ul style="list-style-type: none"> • Over voltage protection (OVP) • Overload protection • Reverse polarity protection |
| Interface | <ul style="list-style-type: none"> • Remote control output On/Off terminal |

Principle of Operation

Block diagram Power supply converts the AC mains into DC Power source for internal units. Channel 1/2/3 control and produce the actual DC output. Display shows output and OVP level, receiving feedback from each channel. Internal components are placed on four printed circuit boards, A ~ D.

Detailed description of each module starts on the next page.

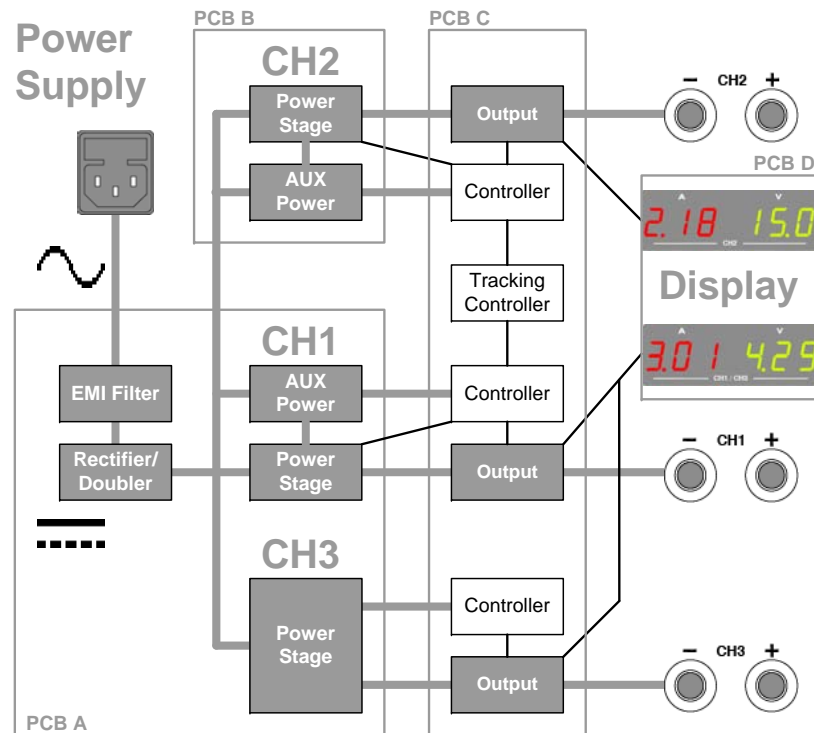

EMI Filter

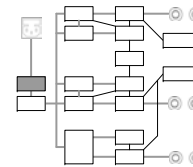

Other than deleting conduction EMI (electromagnetic interference), the EMI unit contains protective circuits such as Inrush current limit resistor and Surge absorber. Internal units are protected under power-up sequence, normal operation, and AC mains fluctuation.

Rectifier / Doubler

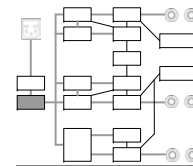

The Rectifier unit converts AC mains into DC Power source. For 115V±15% AC, double-wave rectification is used; for 230V±15% AC, full-wave rectification. An internal selector automatically switches the rectification circuit accordingly. The final DC Voltage reaches 240V ~ 370V.

CH1/2 Power Stage

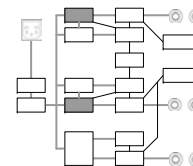

The Power stage for Channel1 and 2 produce the outputs using the combination of Half-bridge converter and Linear regulator. The Half-bridge converter adopts PWM (pulse-width modulation) with high frequency switching. The Linear regulator adjusts the output Voltage down to 0V.

CH1/2 AUX Power

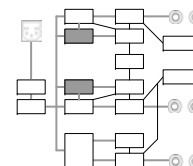

The AUX Power for Channel 1 and 2 produces the power source for auxiliary devices, such as analog/digital controller, relay, LED display, and cooling fan. Altogether four pairs of power source are generated for different purpose: ±12V, +5V, and +12V.

CH3 Power Stage

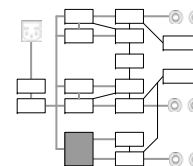

The Power stage for Channel 3 produces both the channel output and the power source for auxiliary devices. It uses the combination of Flyback converter and Linear regulator, carrying lower efficiency compared to Channel 1 and 2. The flyback converter also produces ±12V for ICs and 4~8V settable Voltage.

CH1/2/3 Controller

The Controller for Channel 1, 2, and 3 takes care of the interface between SPD-3606 and users. Several sub-units comprise the Controller, including:

- Feedback control unit
- OVP setting unit
- Fan control unit

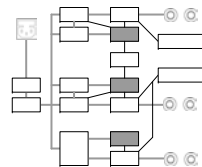

Detailed description of each unit follows.

Feedback control unit

The Feedback control unit receives the control signal for Voltage/Current output level and the level feedback signal from the actual output. The difference between the two signals are amplified and used as the control signal for the Power stage to achieve stable output level.

OVP setting unit

The SVR (small variable resistor) sets the protection point so that the OVP setting unit shuts down the output when the output Voltage level exceeds the configured level.

Fan control unit

Using NTC (negative temperature coefficient) resistor, the Fan control unit changes the control Voltage for the cooling fan according to the temperature change, achieving low-noise and linear speed control.

Tracking Controller

The Tracking controller controls Channel 2 output level when in tracking series or parallel mode. In tracking series mode, Channel2 output Voltage is controlled by Channel1 output Voltage level. In tracking parallel mode, Channel2 output Current is controlled by Channel1 output Current level.

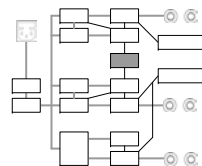



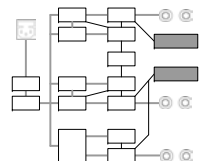

LED Display

The LED display shows the Channel 1/2/3 output Voltage/Current level. The A/D converter changes the analog signal coming from each channel into digital format to be displayed.

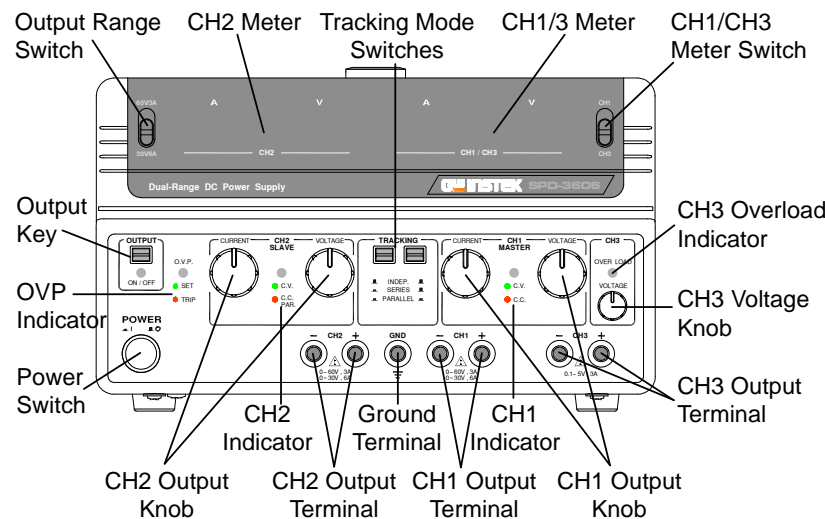

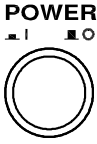
Front Panel Overview



- Power switch**  Turns On or Off the main power. For power up sequence, see page20.
- OVP indicator**  Turns green during the OVP setup. Turns red (tripped) when the output Voltage exceeds the setting. For OVP details, see page22.
- Output Key**  Turns the output On (green) or Off (gray), all three channels at once.
- Output range switch**  Selects the output range, 60V/3A or 30V/6A.

CH2 meter Displays Channel2 current (A) and voltage (V).



Tracking mode switches



Activates and selects the tracking mode. For tracking mode details, see page30 (Series) and page36 (Parallel).

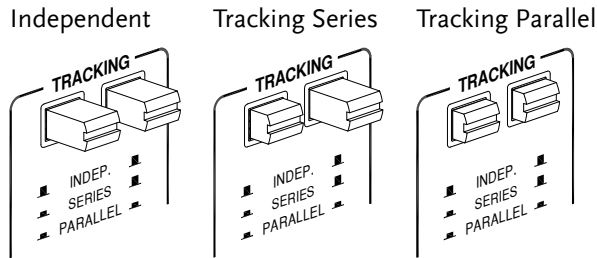
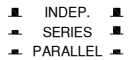

CH1/3 meter + switch Displays Channel1 or Channel3 current (A) and voltage (V). The switch on the right selects the channel, 1 (up) or 3 (down).



Channel3 overload indicator



Turns red when Channel3 output exceeds the current rating, 3A. Channel3 switches from Constant Voltage (CV) mode to Constant Current (CC) mode.

Channel1/2/3 output terminal

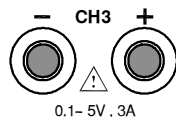

Accepts the load cables. For cable connection details, see page24.

Channel1 CV/CC indicator



Turns green when operating in Constant Voltage (CV) mode, red in Constant Current (CC) mode. For CV/CC characteristics, see page18.

Channel2 CV/CC/PAR indicator

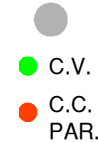

Independent mode: Turns green in Constant Voltage (CV) mode, red in Constant Current (CC) mode.

Tracking parallel mode (page36): When operating in the Tracking Parallel mode, the Channel2 indicator always stays red (PAR). Channel1 indicator shows the CV/CC status.

Rear Panel Overview

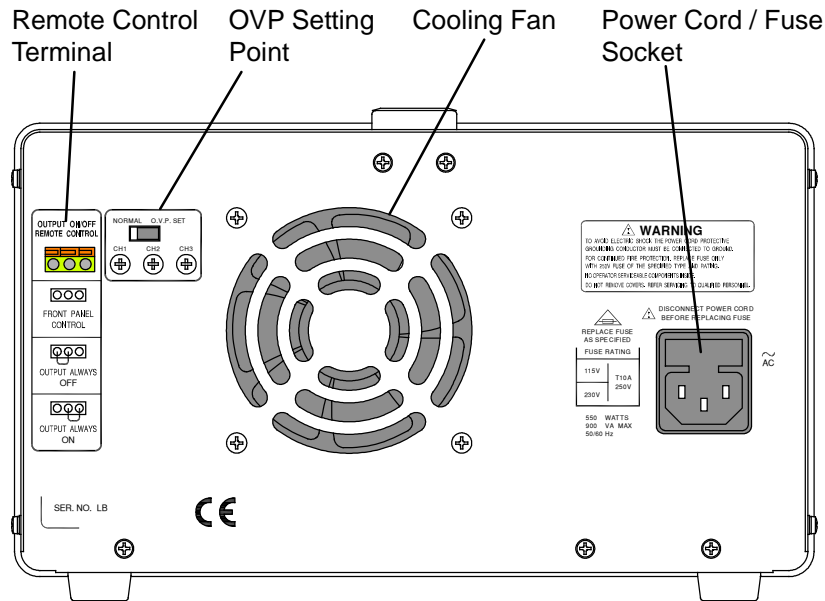

Remote control terminal

OUTPUT ON/OFF REMOTE CONTROL

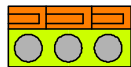

Accepts remote output On/Off control connection. For details, see page39.

OVP setting point

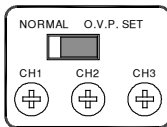

Activates Over Voltage Protection (OVP) and sets the protection threshold for channel1/2/3. For OVP setup details, see page22.

Power cord / fuse socket

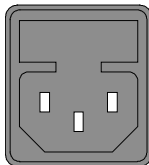

The power cord socket accepts the AC mains: 115V/230V, 50/60Hz. For power up details, see page20.

The fuse holder contains the AC main fuse. For fuse replacement details, see page57.

CV/CC Crossover Characteristics

Background

SPD-3606 automatically switches between constant voltage mode (CV) and constant current mode (CC), according to load condition.

When the current level is smaller than the output setting, SPD-3606 operates in **Constant Voltage mode**. The indicator on the front panel turns green (C.V.) The Voltage level is kept at the setting and the Current level fluctuates according to the load condition until it reaches the output current setting.

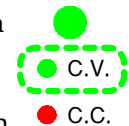

When the current level reaches the output setting, SPD-3606 starts operating in **Constant Current mode**. The indicator on the front panel turns red (C.C.) The Current level is kept at the setting but the Voltage level becomes lower than the setting, in order to suppress the output power level from overload. When the current level becomes lower than the setting, SPD-3606 goes back to the Constant Voltage mode.

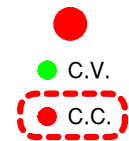

Diagram

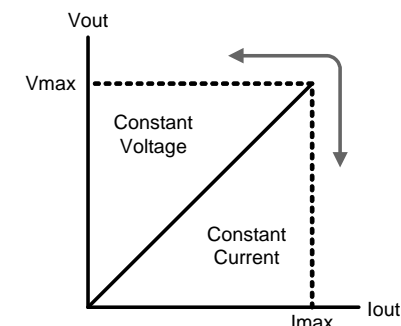

SETUP

This chapter describes how to properly power up and configure SPD-3606 before the operation. For checking the functionality, refer to the Performance verification chapter, page40.

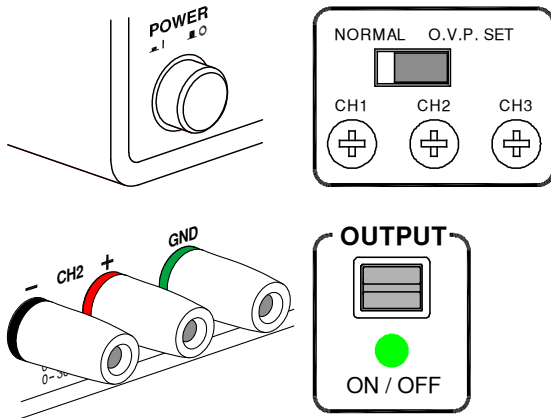

Installation	Installation Location.....	20
Power	Power Up	21
OVP	Over Voltage Protection Set.....	22
Load Wire	Load Cable Connection	24
Output	Output On/Off	25

Installation Location

Ventillation space Leave at least 3cm around SPD-3606, to the left and right.

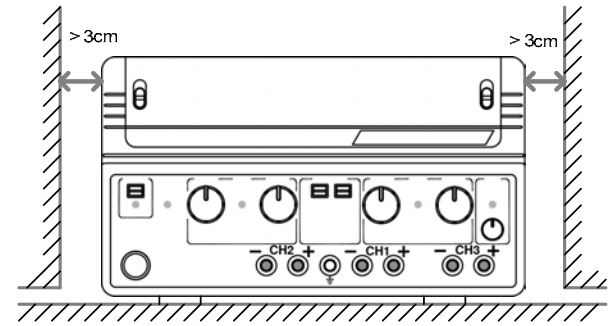

Cooling fan opening

The cooling fan is located on the rear panel. Allocate extra space on the back of SPD-3606 so that the cooling fan opening would not become blocked.

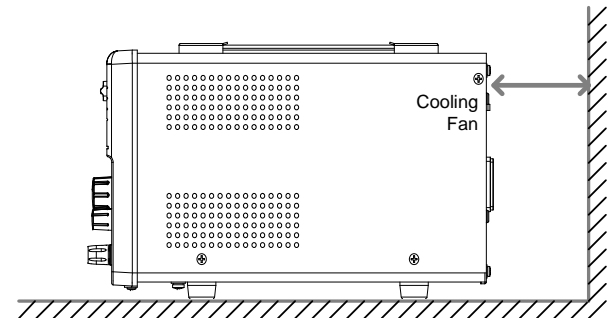

Power Up

Power On

Press the Power switch to turn On the power. The CH1/CH2 indicators and meters turn On.

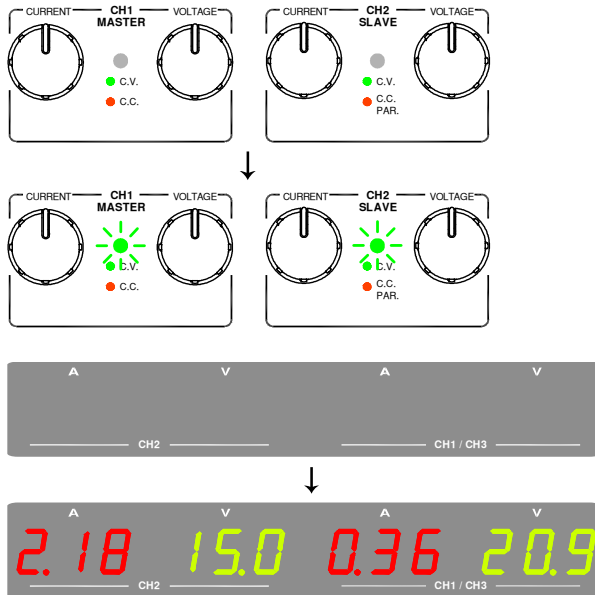
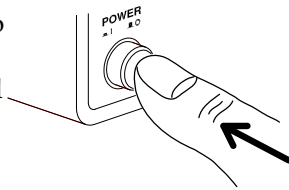

Power Off

Press the Power switch again to turn Off the power. After two seconds, the meters and indicators turn Off.

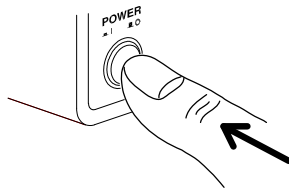

Over Voltage Protection Setup

Background

Over Voltage Protection (OVP) protects SPD and DUT from excessive output Voltage. The user sets the maximum output voltage limit before operation. When the output voltage exceeds this limit, the indicator shows the over voltage status and the output is shut off immediately.

OVP setup

- Slide the rear panel switch to the "O.V.P. SET" position.

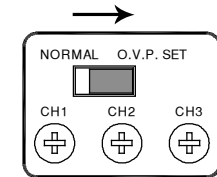

- The OVP indicator on the front panel turns green, indicating OVP setup.

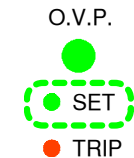

- The Voltage meters show the OVP setting level instead of the output level. The Current meters show zero (0.00).

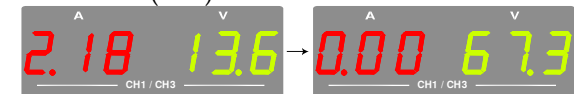

- Adjust the OVP level using the rear panel terminal. The setting on the front panel meter changes accordingly.

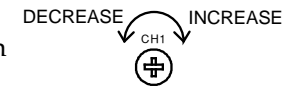

Setting range	Channel1	1.0V ~ 67.0V
	Channel2	1.0V ~ 67.0V
	Channel3	0.1V ~ 6.0V

* When setting the OVP for channel3, select CH3 meter using the CH1/CH3 meter switch.



5. When finished, slide the rear panel switch to the "Normal" position. The OVP indicator on the front panel turns Off.

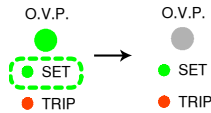
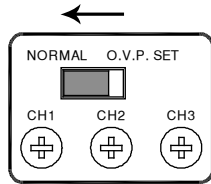

When OVP is activated....

The OVP activates when one of channel1/2/3 output voltage exceeds the OVP setting. The indicator turns red (tripped), and the output is shut Off immediately.

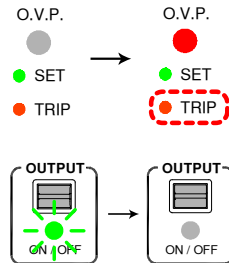

Load Cable Connection

Standard accessory (GTL-104)

1. Turn the terminal counterclockwise and loose the screw.
2. Insert the cable terminal.
3. Turn the terminal clockwise and tighten the screw.

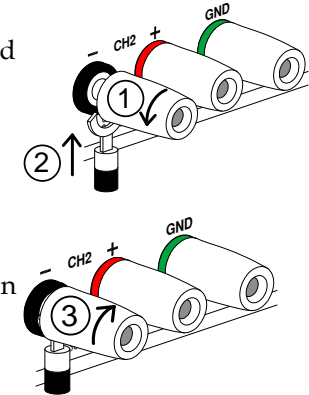

Banana plug

Insert the plug into the socket.

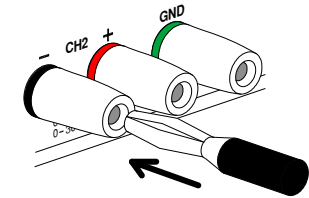

Wire type

When using load cables other than the attached, make sure they have enough current capacity for minimizing cable loss and load line impedance. Voltage drop across a wire should not exceed 0.5V. The following list is the wire current rating at 450A/cm².

Wire size (AWG)	Maximum current (A)
20	2.5
18	4
16	6
14	10
12	16

Output On/Off

Panel operation Pressing the Output key once Turns On the output, all channels 1/2/3 at once.

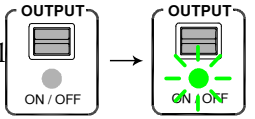

Pressing again turns Off the output.

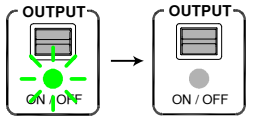

Automatic Output Off Any of the following actions during output On automatically turns it Off. They might involve sudden and harmful change in the output level.

Change the range



Change the tracking SW between independent / series / parallel

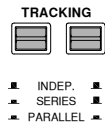

OVP tripped

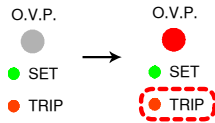

OVP SET mode

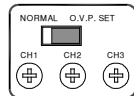

Remote control When in remote control mode (page39), front panel output control is disabled.

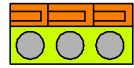

! CV/CC red without output

Red CV/CC indicator when output Off indicates internal error. Contact the service center.

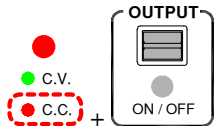

OPERATION

CH1/CH2 Independent Mode

Background / Connection Channel1 and Channel2 outputs work independent of each other and are separately controlled.

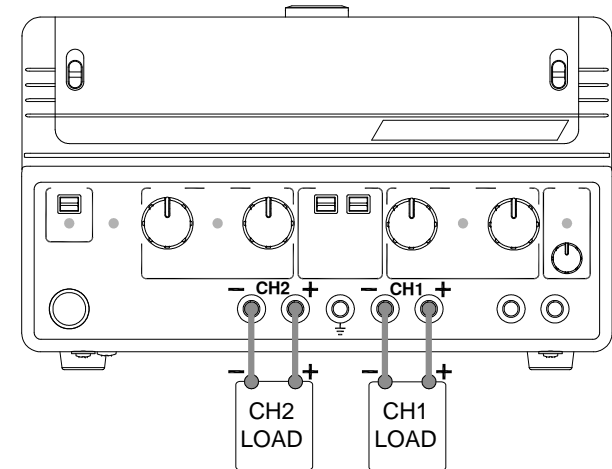



Output rating 0 ~ 30V/0~6A or 0~60V/0~3A for each channel

Setting step

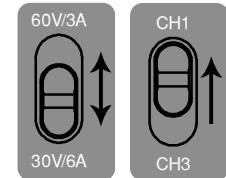
1. Select the output range, 60V/3A or 30V/6A. Set the CH1/CH3 meter switch to the CH1 position.



- Set the tracking switch position to INDEP,  + .

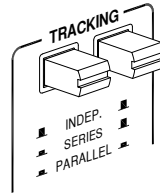

- Set the OVP if necessary. For details, see page22.



- Connect the load to the front panel terminals, channel1 +/-, channel2 +/-.

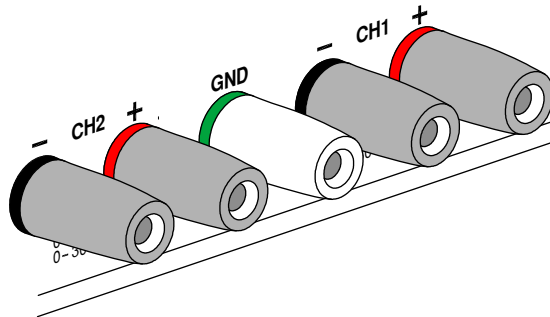

- Set the output Voltage and Current using the control knobs for each channel.

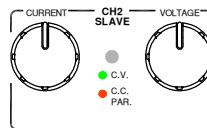
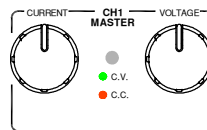

- Press the Output key. The Output indicator turns green.

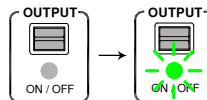

CH3 Independent Mode

Background / Connection

Channel3 rating is 0.1 ~ 5V, maximum 3A. It works independently from Channel1 and 2, regardless of their modes.

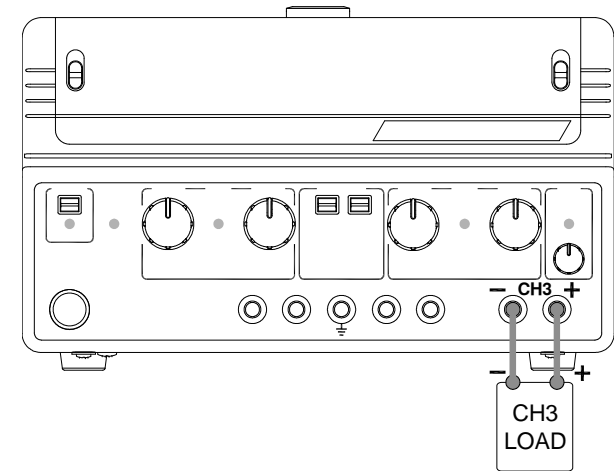

Output rating 0.1 ~ 5V, 3A maximum

No Tracking Series/Parallel

Channel3 does not have Tracking Series/Parallel mode. Also, Channel3 output is not affected by Channel1 and 2 modes: independent/series/parallel.

Setting step

- Set the CH1/CH3 meter switch to the CH3 position.



2. Set the OVP if necessary. For details, see page22.



3. Connect the load to the front panel channel3 +/- terminal.

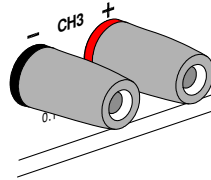

4. Set the output Voltage using the Channel3 Voltage control knob.

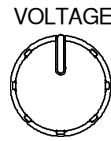

5. Press the Output key. The Output indicator turns green.

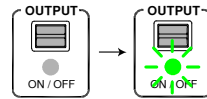

CV → CC

When the output Current level exceeds 3A, the overload indicator turns red and Channel3 operation mode switches from Constant Voltage to Constant Current.

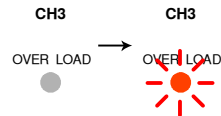

Note: “overload” in this case does not mean abnormal operation.

CH1/CH2 Tracking Series Mode

Background

Tracking series operation doubles the Voltage capacity of SPD-3606 by internally connecting Channel1 (Master) and Channel2 (Slave) in serial and combining the output to a single channel. Channel1 (Master) controls the combined Voltage output level.

The following describes two types of configuration depending on the common ground usage.

Tracking series without common terminal

Connection

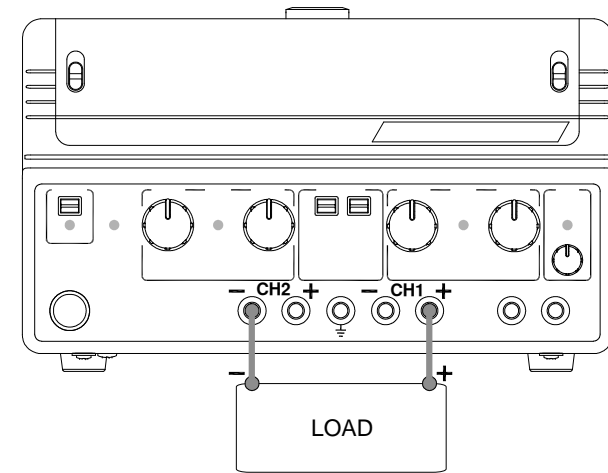

Output rating 0 ~ 120V/0 ~ 3A or 0 ~ 60V/0 ~ 6A

Setting step

1. Select the output range, 60V(120V)/3A or 30V(60V)/6A. Set the CH1/CH3 meter switch to the CH1 position.

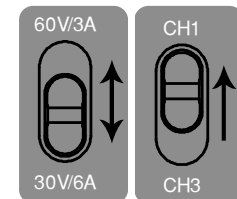

- Set the tracking switch position to Series,  + .

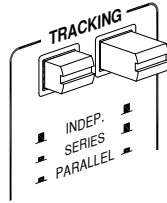

- Set the OVP if necessary. In tracking series mode, set the Channel2 (Slave) OVP setting to the maximum level, so that the OVP trips if the Channel1 (Master) setting is violated. For OVP setup details, see page22.



- Connect the load to the front panel terminals, channel1+ & channel2- (Single supply).

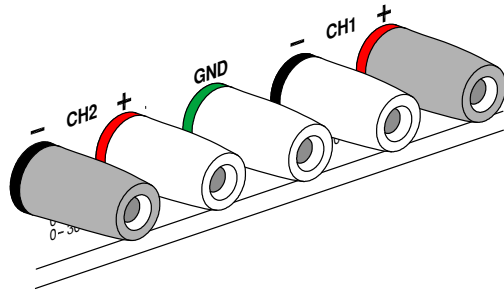

- Turn up the Channel2 Current knob to maximum.

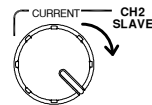

- Set the output Voltage and Current using the Channel1 (Master) knob.

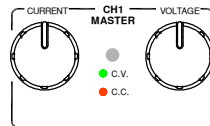

- Refer to the Channel1 (Master) meter and indicator for the output setting level and CV/CC status.



Current level Channel1 meter reading shows the output Current. (Channel2 Current control must be in the Maximum position).

Voltage level Double the reading on the Channel1 Voltage meter. (In the above case, the actual output is $23.6 \times 2 = 47.2V$).

- Press the Output key. The Output indicator turns green.

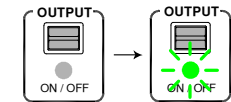

Tracking series with common terminal

Connection

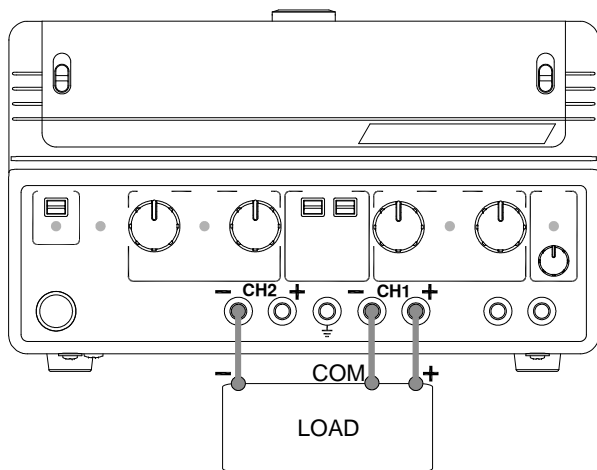

Output rating 0~60V/0~3A or 0~30V/0~6A for CH1 ~ COM
 0~-60V/0~3A or 0~-30V/0~6A for CH2 ~ COM

Setting step

1. Select the output range, 60V(120V)/3A or 30V(60V)/6A. Set the CH1/CH3 meter switch to the CH1 position.

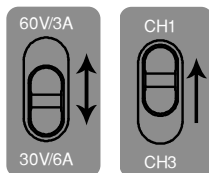

2. Set the tracking switch position to Series, \blacksquare + \blacksquare .

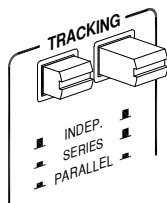

3. Set the OVP if necessary. In tracking series mode, set the Channel2 (Slave) OVP setting to the maximum level, so that the OVP trips if the Channel1 (Master) setting is violated. For OVP setup details, see page22.



4. Connect the load to the front panel terminals, channel1+ & channel2-. Use Channel1 (-) terminal as the common line connection.

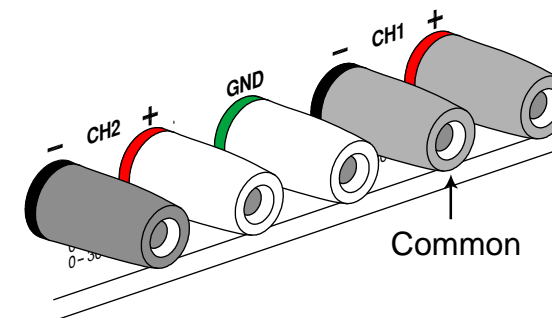

5. Set the output Voltage using the Channel1 (Master) Voltage knob. Refer to the Channel1 (Master) meter for the output setting level.

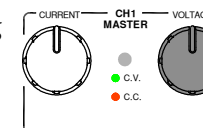

CH1 (+)~COM Voltage = 23.6V in the above case
 CH2 (-)~COM Voltage = -23.6V in the above case

- Set the output Current separately, using both the Channel1 (Master) and Channel2 (Slave) Current knob.

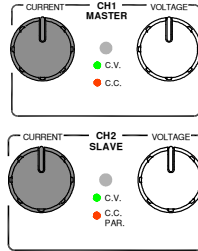

CH1(+)-COM Current = 1.84A in the above case

CH2(-)-COM Current = 2.18A in the above case

- Press the Output key. The Output indicator turns green.

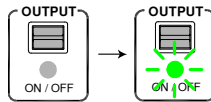

- Refer to the Channel1 (Master) indicator for CH1(+)-COM CV/CC status, and the Channel2 (Slave) indicator for CH2(-)-COM CV/CC status.

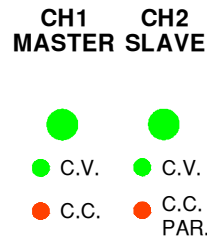

CH1/CH2 Tracking Parallel Mode

Background / Connection

Tracking parallel operation doubles the Current capacity of SPD-3606 by internally connecting Channel1 (Master) and Channel2 (Slave) in parallel and combining the output to a single channel. Channel1 (Master) controls the combined output.

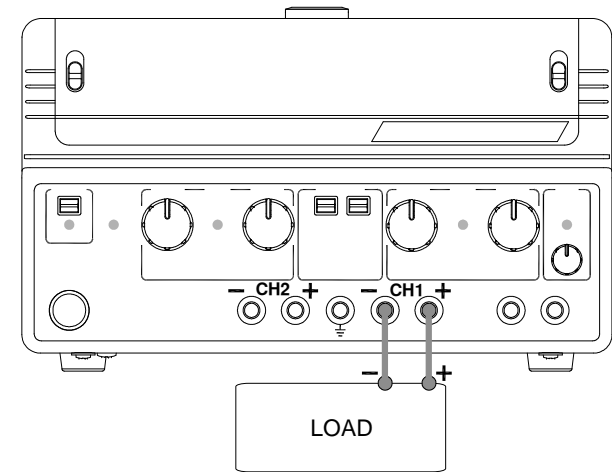

Output rating 0 ~ 30V/0 ~ 12A or 0 ~ 60V/0 ~ 6A

Setting step

- Select the output range, 60V/3A(6A) or 30V/6A(12A). Set the CH1/CH3 meter switch to the CH1 position.

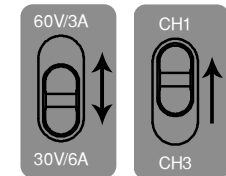

- Set the tracking switch position to Parallel, $\text{---} + \text{---}$.

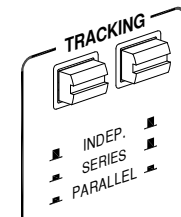

- Set the OVP if necessary. In tracking parallel mode, set the Channel2 (Slave) OVP setting to the maximum level, so that the OVP trips if the Channel1 (Master) setting is violated. For OVP setup details, see page22.



- Connect the load to the front panel terminals, channel1 +/-.

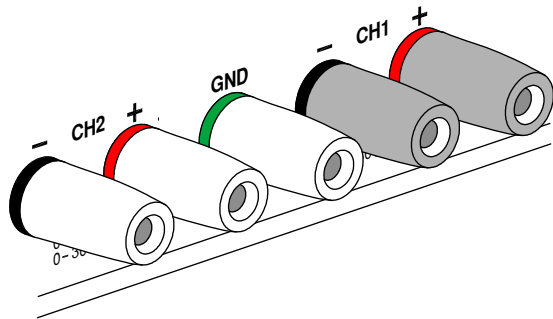

- The Channel2 (Slave) indicator turns red, indicating Tracking Parallel (PAR). The CV/CC status of tracking parallel mode is displayed in the Channel1 (Master) indicator.

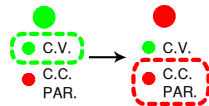

- Set the output Voltage and Current using the Channel1 (Master) control knobs. Channel2 control knobs are disabled.

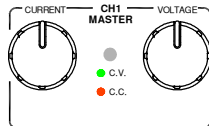

- Refer to the Channel1 meter for the output setting level.



Current level Double the reading on the Channel1 meter. In the above case, the actual output is $1.84 \times 2 = 3.68\text{A}$.

Voltage level Channel1 meter reading shows the actual output Voltage.

- Press the Output key. The Output indicator turns green.

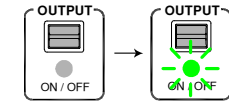

- Refer to the Channel1 (Master) indicator for the CV/CC status.



REMOTE OUTPUT CONTROL

Background The remote control terminal on the rear panel can turn the output On/Off, just like the Output key on the front panel. This feature is useful for automated measurement and testing using externally connected control device, such as in production line or incoming quality inspection.

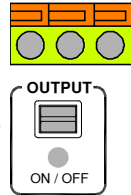

Wire connection Connect the terminals using bare wires. Use a minus driver to push the orange part, insert the wire, then release the orange part.

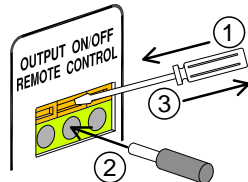

Remote control Off (front panel control) When there is no connection, Output On/Off is entirely controlled from the front panel.

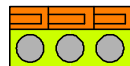

Output always Off When the left two terminals are connected, the Output is always Off. The front panel Output key is disabled.

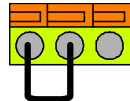

Output always On When the right two terminals are connected, the Output is always On. The front panel Output key is disabled.

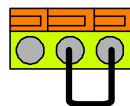

PERFORMANCE VERIFICATION

Overview

Background Performance verification checks SPD functionality before the operation or at the incoming inspection. Recording tables are attached at the end of this chapter.

- Verification item**
- Output Voltage
 - Tracking Series Voltage
 - Output Current
 - OVP

Equipment









- Digital Multimeter**
- DCV Accuracy < 0.1%
 - DCA Accuracy < 0.5%
 - DCA range: ≥ 12A
 - Resolution ≥ 4 ½ digit
 - Recommended model: GDM-8245, GDM-8246

- Multimeter – SPD cable**
- Voltage rating > 70V
 - Current rating > 12A

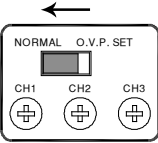
- Philips screw driver**
- < 3mm (for OVP adjustment)

Default SPD-3606 setting

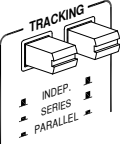
The following is the required front and rear panel setting before running each verification.



Range	60V/3A		30V/6A	
		<ul style="list-style-type: none"> • Output Voltage • Tracking Series • OVP 		<ul style="list-style-type: none"> • Output Current • Tracking Parallel
OVP setting SW	Normal position			
				
Channel1/3 meter CH1 position SW				
				
Tracking SW	Independent position,  +  .			
				
Channel1/2/3 Voltage knob	Minimum position			
				
Channel1/2 Current knob	Minimum position			
				

Output Voltage Verification

- Check item
- Minimum output Voltage accuracy
 - Maximum output Voltage accuracy
 - Voltage meter accuracy (Output On)
 - Voltage meter accuracy (Output Off)

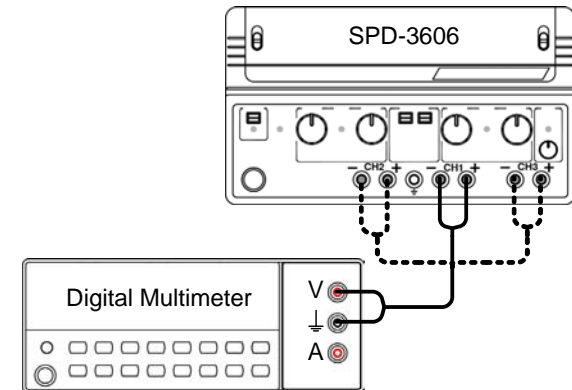
Connection

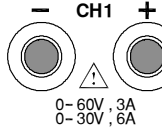

- Verification step
1. Set the SPD panel according to the Default setting list, page41.
 2. Connect SPD Channel 1 and Digital Multimeter Voltage terminal. 
 3. Power up SPD and Digital Multimeter.
 4. Turn up the SPD Current knob to the maximum. 

5. Turn On the SPD output.

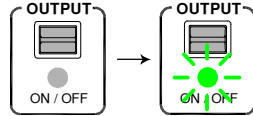

Minimum output Voltage 6. Record the Multimeter reading as the Minimum output Voltage. Here is the acceptance range.

Channel1/2	< 0V
Channel3	< 100mV

7. Turn up the SPD Voltage knob to the maximum. Switch the Multimeter Voltage terminal if necessary.

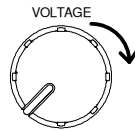

Maximum output Voltage 8. Record the Multimeter reading as the Maximum output Voltage. Here is the acceptance range.

Channel1/2	61.5V ~ 62.5V
Channel3	5.20V ~ 5.30V

Voltage meter accuracy 9. Compare and record the difference between the SPD Voltage meter and the Multimeter reading as the Voltage meter accuracy (Out On).

Then turn the output Off, and check the SPD reading again (Out Off).

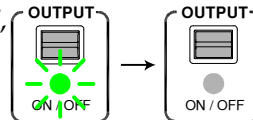

Here is the acceptance range and example.

Channel1/2/3	difference < ±(0.5% of reading + 2 digits) of Multimeter
--------------	--

Example:

Multimeter (Out On) = 30.00V

Tolerance = ±(0.005*30 + 0.2) ≈ ±0.4V

Accepted SPD reading(Out On)= 29.6V~30.4V

Accepted SPD reading (Out Off)=29.6V~30.4V

Channel2

10. Connect the Multimeter to SPD Channel2 and repeat step 4 to 9.

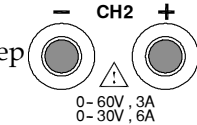

Channel3

11. Switch the CH1/CH3 meter switch to CH3 position. Connect the Multimeter to Channel3 and repeat step 5 to 9.

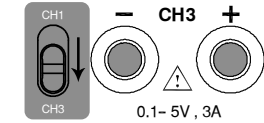

* Skip step 4 since Channel 3 does not have Current knob.

Tracking Series Voltage Verification

- Check item
- Minimum output Voltage accuracy
 - Maximum output Voltage accuracy

Connection

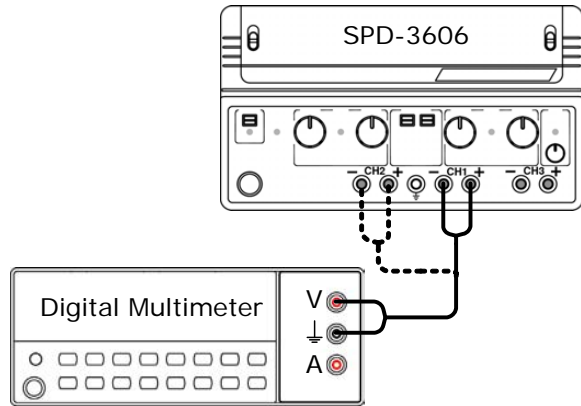

Verification step1. Set the SPD panel according to the Default setting list, page41, except for the tracking switch (see below).

2. Set the tracking switch position to Series, **■** + **■**.

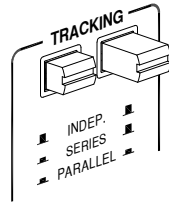

3. Connect SPD Channel 1 and Digital Multimeter Voltage terminal.

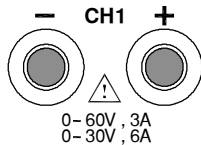

4. Power up SPD and Digital Multimeter.

5. Turn up the SPD Current knob, both Channel1 and Channel2, to the maximum.

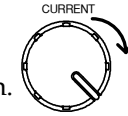

6. Turn On the SPD output.

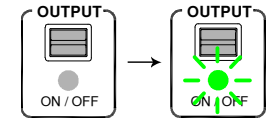

7. Turn up the SPD Channel1 Voltage knob until the Multimeter reading shows 1.000V.

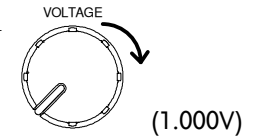

Minimum tracking series output voltage

8. Connect the Multimeter to SPD Channel2 and record the reading. Here is the acceptance range.

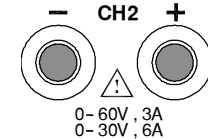

Channel2	0.985V ~ 1.015V
----------	-----------------

9. Connect Digital Multimeter back to SPD Channel1.

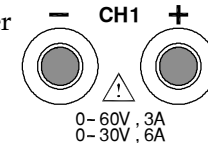

10. Turn up the SPD Channel1 Voltage knob until the Multimeter reading shows 60.00V.

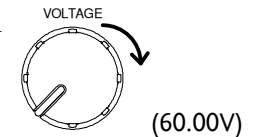

Maximum tracking series output voltage

11. Connect the Multimeter to SPD Channel2 and record the reading. Here is the acceptance range.

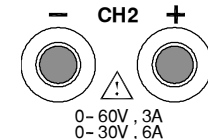

Channel2	59.69V ~ 60.31V
----------	-----------------

Output Current verification

- Check item
- Minimum output Current accuracy
 - Maximum output Current accuracy
 - Current meter accuracy (Output On)
 - Current meter accuracy (Output Off)

Connection

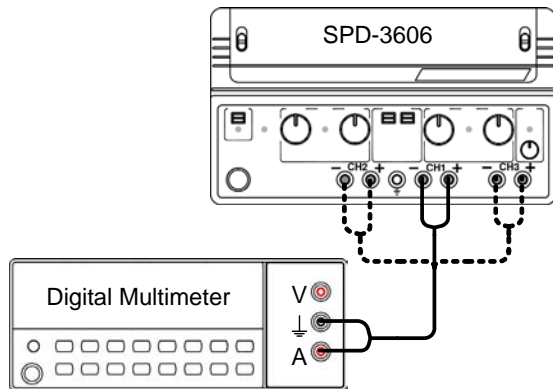

Verification step 1. Set the SPD panel according to the Default setting list, page41.

2. Connect SPD Channel 1 and Digital Multimeter Current terminal.

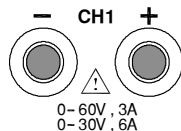

3. Power up SPD and Digital Multimeter.

4. Turn up the SPD Voltage knob to the maximum.

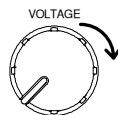

5. Turn On the SPD output.

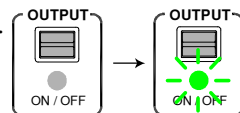

Minimum output Current 6. Record the Multimeter reading as the Minimum output Current. Here is the acceptance range.

Channel1/2	< 0A
------------	------

7. Turn up the SPD Current knob to the maximum. Switch the Multimeter Current terminal to high current range.

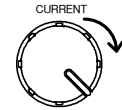

Maximum output Current 8. Record the Multimeter reading as the Maximum output Current. Here is the acceptance range.

Channel1/2	6.15A ~ 6.25A
Channel3	3.05A ~ 3.15A

Current meter accuracy 9. Compare and record the difference between the SPD Current meter and the Multimeter reading as the Current meter accuracy (Out On).

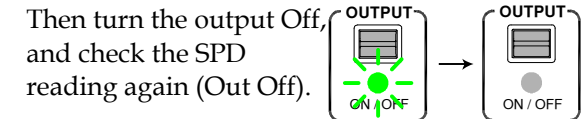

Then turn the output Off, and check the SPD reading again (Out Off).

Here is the acceptance range and example.

Channel1/2/3	difference < $\pm(0.5\% \text{ of reading} + 2 \text{ digits})$ of Multimeter
--------------	---

Example:

Multimeter (Out On) = 3.000A

Tolerance = $\pm(0.005 \times 3 + 0.02) \approx \pm 0.04A$

Accepted SPD reading(Out On)= 2.96A~3.04A

Accepted SPD reading (Out Off)= 2.96A~3.04A

10. Connect the Multimeter to SPD Channel2 and repeat step 4 to 9.

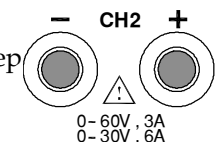

11. Connect the Multimeter to SPD Channel3 and repeat step 4, 5, 8, 9.

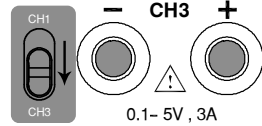

* Skip step 6 and 7 since Channel 3 does not have minimum current verification and Current knob.

OVP verification

- | | |
|------------|--|
| Check item | <ul style="list-style-type: none"> • OVP setting accuracy (Minimum) • OVP functionality (Minimum) • OVP setting accuracy (Maximum) • OVP functionality (Maximum) |
|------------|--|

Connection

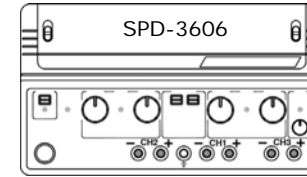

(No connection)

Verification step 1. Set the SPD panel according to the Default setting list, page41.

2. Power up SPD.

3. Set the OVP setting switch to the "O.V.P. SET" position.

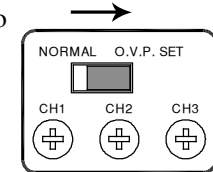

4. The O.V.P. indicator on the front panel turns green.

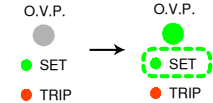

5. Turn down the OVP setting terminal to minimum.

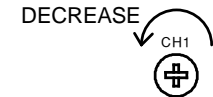

Minimum OVP setting

- Record the SPD Voltage meter reading as the Minimum OVP setting accuracy. Here is the acceptance range.

Channel1/2	≤ 1.0V
Channel3	≤ 0.50V

- Adjust the OVP setting terminal until the SPD meter shows the exact following value.

Channel1/2	1.0V
Channel3	0.50V

- Set the OVP setting switch to the "Normal" position. The OVP indicator on the front panel turns Off.

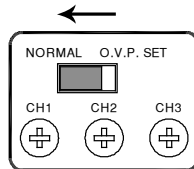

- Turn On the SPD output.

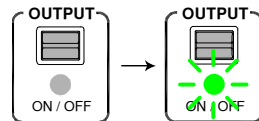

- Slowly turn up the SPD Voltage knob until the OVP indicator turns red (tripped).

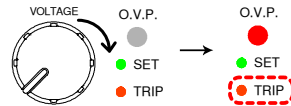

Minimum OVP functionality

- Record the SPD Voltage meter reading as the Minimum range OVP functionality. Here is the acceptance range.

Channel1/2	0.5V ~ 1.5V
Channel3	0.00V ~ 1.00V

- Turn Off the SPD output.

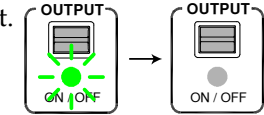

- Set the OVP setting switch to the "O.V.P. SET" position.

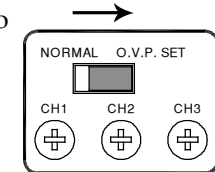

- The O.V.P. indicator on the front panel turns green.

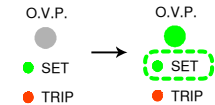

- Turn up the OVP setting terminal to maximum.



Maximum OVP setting

- Record the SPD Voltage meter reading as the Maximum OVP setting accuracy. Here is the acceptance range.

Channel1/2	65.0 ~ 68.0V
Channel3	6.00 ~ 7.00V

- Adjust the OVP setting terminal until the SPD meter shows the exact following value.

Channel1/2	60.0V
Channel3	5.0V

- Set the OVP setting switch to the "Normal" position. The OVP indicator on the front panel turns Off.

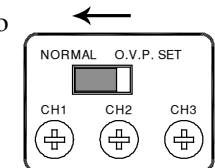

19. Turn On the SPD output.

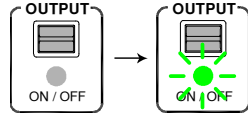

20. Slowly turn up the SPD Voltage knob until the OVP indicator turns red (tripped).

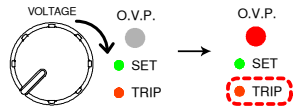

Maximum OVP functionality

21. Record the SPD Voltage meter reading as the Maximum range OVP functionality. Here is the acceptance range.

Channel1/2	59.2V ~ 60.8V
Channel3	4.47V ~ 5.53V

22. Turn Off the SPD output.

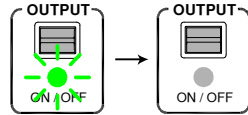

23. Repeat step 3 to 22 for Channel2.

24. Repeat step 3 to 22 for Channel3.

Recording Tables

Output voltage verification (Minimum/Maximum)

Item	Channel	Min. limit	Result	Max. limit
Minimum Output Voltage	CH1	-30mV		0mV
	CH2	-30mV		0mV
	CH3	0mV		100mV
Maximum Output Voltage	CH1	61.5V		62.5V
	CH2	61.5V		62.5V
	CH3	5.2V		5.3V

Output voltage verification (Meter accuracy)

Tolerance = $\pm (0.5\% * \text{Multimeter} + 0.2) \text{ V}$

Channel	Multimeter	Tolerance	SPD (On)	SPD (Off)
Channel1		~		
Channel2		~		
Channel3		~		

Tracking series voltage verification

Item	Channel	Min. limit	Result	Max. limit
Tracking Series Minimum	CH2	0.985V		1.015V
	CH2	59.69V		60.31V

Output current verification (Minimum/Maximum)

Item	Channel	Min. limit	Result	Max. limit
Minimum Output Current	CH1	-1mA		0mA
	CH2	-1mA		0mA
Maximum Output Current	CH1	6.15A		6.25A
	CH2	6.15A		6.25A
	CH3	3.05A		3.15A

Output current verification (Meter accuracy)

Tolerance = ± (0.5%*Multimeter +0.02) A

Channel	Multimeter	Tolerance	SPD (On)	SPD (Off)
Channel1		~		
Channel2		~		
Channel3		~		

OVP verification

Item	Channel	Min. limit	Result	Max. limit
Minimum OVP Setting	CH1	0.0V		1.0V
	CH2	0.0V		1.0V
	CH3	0.0V		0.1V
Minimum OVP Functionality	CH1	0.5V		1.5V
	CH2	0.5V		1.5V
	CH3	0.00V		1.00V
Maximum OVP Setting	CH1	65.0V		68.0V
	CH2	65.0V		68.0V
	CH3	6.0V		7.0V
Maximum OVP Functionality	CH1	59.2V		60.8V
	CH2	59.2V		60.8V
	CH3	4.47V		5.53V

FAQ

Q1. I cannot turn On the output (the Output key does not respond).

A1. The following scenarios are possible.

- The rear panel remote control terminal is in the Off position. In this case, set it to the On position or deactivate remote control. For details, see page39.
- The OVP setting switch on the rear panel is on the SET side. In this case, set the switch to the Normal side.
- The OVP indicator is red. In this case, change the OVP setting to higher value or remove the over voltage condition.

Note that in several conditions, the Output key automatically turns Off to avoid harmful condition. For details, see page25.

Q2. The CV/CC indicator is red (Constant Current) while the output is Off.

A2. This indicates there is an internal error. Contact the service center.

Q3. The meter does not match the real value.

A3. The following scenarios are possible.

- Make sure the rear panel OVP setting is in the “Normal” position. If the OVP switch is in the “SET” position, the meter might show the OVP setting, not the output value. For OVP details, see page22.
- If you are using Channel1 or Channel3, make sure the meter switch on the right side is in the correct position. Channel1 and 3 share the same meter.

For more information, contact your local dealer or GWInstek at www.gwinstek.com.tw / marketing@goodwill.com.tw.

APPENDIX

Fuse Replacement

- Step 1. Take off the power cord and remove the fuse socket using a minus driver.

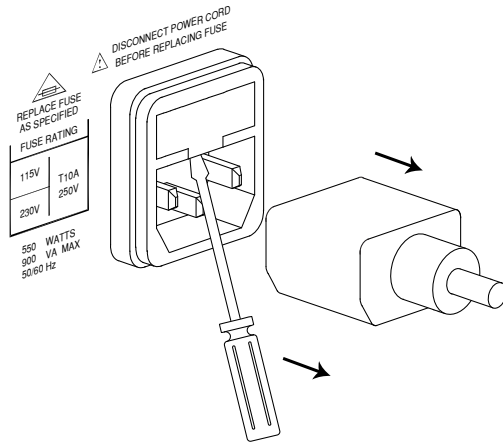

2. Replace the fuse in the holder.

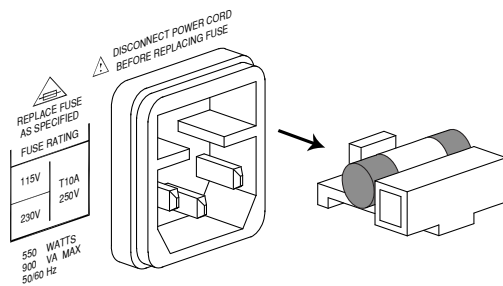

Rating T10A/250V

Volume Guard (Optional)

Background The volume guard is an optional item which replaces the Channel 1 and 2 output knobs to prevent accidentally changing the output level. This feature is useful for automated testing at fixed output level, such as assembly line inspection.

- Applicable knobs**
- Channel 1 Voltage and Current knob
 - Channel2 Voltage and Current knob

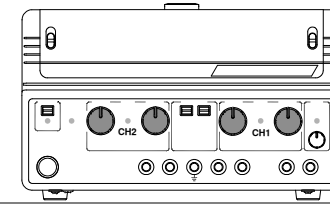

- Attach volume guard**
1. Pull out the original knob (Channel2 current knob for example).

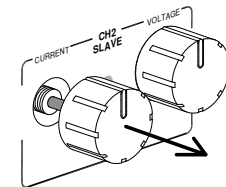

2. Insert and screw the volume guard to fix its position.

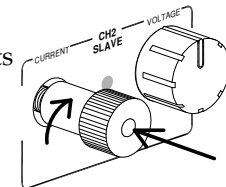

3. To change the output level, use a minus screwdriver from the opening of the volume guard.

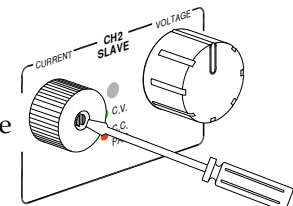

Specification

Output Ratings	CH1/CH2 Independent	0 ~ 30V / 0 ~ 6A 0 ~ 60V / 0 ~ 3A
	CH1/CH2 Series	0 ~ 60V / 0 ~ 6A 0 ~ 120V / 0 ~ 3A
	CH1/CH2 Parallel	0 ~ 30V / 0 ~ 12A 0 ~ 60V / 0 ~ 6A
	CH3	0.1 ~ 5V / 3A
	Voltage Regulation	Line
Load		$\leq 0.01\% + 5\text{mV}$ (rating current $\leq 6\text{A}$) $\leq 0.01\% + 8\text{mV}$ (rating current $\leq 12\text{A}$)
Ripple & Noise		$\leq 5\text{mVrms}$ (5Hz ~ 1MHz) $\leq 50\text{mV}_{\text{P-P}}$ (20Hz ~ 20MHz)
Recovery Time		$\leq 100\mu\text{s}$ (50% load change, minimum load 0.5A)
Current Regulation	Line	$\leq 0.2\% + 3\text{mA}$
	Load	$\leq 0.2\% + 3\text{mA}$
	Ripple & Noise	$\leq 3\text{mA}_{\text{rms}}$
Tracking Operation	Tracking Error	$\leq 0.5\% + 10\text{mV}$ of Master
	Series Regulation	$\leq 300\text{mV}$
	Ripple & Noise	$\leq 10\text{mVrms}$ (5Hz ~ 1MHz) $\leq 100\text{mV}_{\text{pp}}$ (20Hz ~ 20MHz)

Output On/Off Response Time	Voltage Up (10% ~ 90%)	$\leq 100\text{ms}$ ($\leq 95\%$ rating load)
	Voltage Down (90% ~ 10%)	$\leq 100\text{ms}$ ($\geq 10\%$ rating load)
OVP	Accuracy	$\pm (0.5\% \text{ of reading} + 0.5\text{V})$
Meter	Type	3 ½ digits 0.5" LED display
	Accuracy	$\pm (0.5\% \text{ of reading} + 2 \text{ digits})$
	Resolution	100mV/10mA
Insulation	Chassis and Terminal	100M Ω or above (DC 1000V)
	Chassis and AC cord	100M Ω or above (DC 1000V)
Temperature Coefficient	Voltage	$\leq 100\text{ppm}/^\circ\text{C} + 3\text{mV}$
	Current	$\leq 150\text{ppm}/^\circ\text{C} + 3\text{mA}$
Remote Control	Output On/Off	
Fan Noise		$\leq 50\text{dB}$
Operation Environment	Ambient temperature	0 ~ 40°C
	Relative humidity	$\leq 80\%$
Storage Environment	Ambient temperature	-10 ~ 70°C
	Relative humidity	$\leq 70\%$
Power Source		AC 115V/230V $\pm 15\%$, 50/60Hz
Accessories		User manual x 1, Power cord x 1
		Test lead GTL-104 x 2, GTL-105 x 1
Dimensions		255 (W) x 145 (H) x 265 (D) mm
Weight		Approx. 6kg

Declaration of Conformity

We

GOOD WILL INSTRUMENT CO., LTD.

(1) No.7-1, Jhongsing Rd., Tucheng City, Taipei County, Taiwan

(2) No. 69, Lu San Road, Suzhou City (Xin Qu), Jiangsu Sheng, China

declare, that the below mentioned product

Type of Product: Power Supply

Model Number: SPD-3606

are herewith confirmed to comply with the requirements set out in the Council Directive on the Approximation of the Law of Member States relating to Electromagnetic Compatibility (2004/108/EC, 89/336/EEC, 92/31/EEC, 93/68/EEC) and Low Voltage Directive (73/23/EEC, 93/68/EEC).

For the evaluation regarding the Electromagnetic Compatibility and Low Voltage Directive, the following standards were applied:

© **EMC**

EN 61326-1: 2006 Electrical equipment for measurement, control and laboratory use -- EMC requirements		
Conducted Emission	Class A	Electrostatic Discharge
Radiated Emission		
EN 55011: 1998 + A1:1999 + A2:2002		EN 61000-4-2: 1995 + A1:1998 + A2:2001
Current Harmonics		Radiated Immunity
EN 61000-3-2: 2000 + A2:2005		EN 61000-4-3: 2002 + A1:2002
Voltage Fluctuations		Electrical Fast Transients
EN 61000-3-3: 1995 + A1:2001 + A2:2005		EN 61000-4-4: 2004
-----		Surge Immunity
		EN 61000-4-5: 1995 + A1:2001
-----		Conducted Susceptibility
		EN 61000-4-6: 1996 + A1:2001
-----		Power Frequency Magnetic Field
		EN 61000-4-8: 1993 + A1:2001
-----		Voltage Dip/ Interruption
		EN 61000-4-11: 2004

© **Safety**

Low Voltage Equipment Directive 73/23/EEC & amended by 93/68/EEC
Safety Requirements
IEC/EN 61010-1: 2001

INDEX

block diagram, system	11	rating	57
caution symbol.....	5	replacing	57
cleaning the instrument	7	safety instruction	6
constant current mode	18	socket overview	17
constant voltage mode.....	18	ground symbol.....	5
cooling fan.....	20	list of features	10
noise level spec	60	load connection	
safety instruction	6	independent mode	26
CV/CC		procedure.....	24
indicator overview	16	tracking parallel.....	36
overview	18	tracking series	30, 33
default setting for verification .	41	wire type.....	24
EN 55011	61	meter	
EN 61000.....	61	ch1/ch3 switch.....	28
EN61010		faq.....	56
declaration of conformity.....	61	OVP mode	22
measurement category	6	multimeter for verification	40
pollution degree.....	7	output current	
environment		recording table.....	54, 55
operation.....	7	specification.....	59
specification.....	60	verification.....	47
storage	7	output on/off	
front panel diagram	14	faq.....	56
fuse		key overview	14

manual.....	25	socket overview	17
remote.....	39	specification.....	60
response time spec	60	switch overview.....	14
output range		rear panel diagram.....	17
independent mode	26	remote output control	
specification.....	59	disable manual control	25
switch overview.....	14	setup	39
tracking parallel.....	36	terminal overview	17
tracking series	30, 33	service operation	
output voltage		about disassembly	6
recording table	54, 55	contact point.....	56
specification.....	59	tracking mode	
technical background.....	13	parallel.....	36
verification.....	42, 45	parallel indicator overview.....	16
overload indicator		series	30
description.....	29	specification.....	59
overview	15	tracking series	
OVP		common ground	33
automatic output off	25	tracking switch	
indicator overview	14	automatic output off	25
recording table	55	independent mode	27
setting terminal overview	17	overview	15
setup	22	tracking parallel.....	36
verification.....	50	tracking series	31, 33, 45
when activated.....	23	UK power cord	8
power supply		ventillation space requirement	20
power on/off.....	21	volume guard	58
safety instruction	6	warning symbol	5