

DC Power Supply

GPD-3303 Series

USER MANUAL

GW INSTRUMENT PART NO.

This manual contains proprietary information, which is protected by copyrights. All rights are reserved. No part of this manual may be photocopied, reproduced or translated to another language without prior written consent of Good Will company.

The information in this manual was correct at the time of printing. However, Good Will continues to improve products and reserves the rights to change specification, equipment, and maintenance procedures at any time without notice.



ISO-9001 CERTIFIED MANUFACTURER

GW INSTRUMENT

Good Will Instrument Co., Ltd.
No. 7-1, Jhongsing Rd., Tucheng City, Taipei County 236, Taiwan.

Table of Contents

SAFETY INSTRUCTIONS	5
OVERVIEW	9
Introduction.....	9
Series Lineup / Main Features	11
Principle of Operation.....	12
Front Panel Overview	14
Rear Panel Overview	17
CV/CC Crossover Characteristics	18
SETUP	19
Power Up	19
Load Cable Connection	20
Output On/Off.....	21
Beep On/Off.....	21
Front Panel Lock.....	22
OPERATION	23
CH1/CH2 Independent Mode	23
CH3 Independent Mode.....	25
CH1/CH2 Tracking Series Mode.....	27
CH1/CH2 Tracking Parallel Mode	32
SAVE/RECALL SETUP	34
Save Setup	34
Recall Setup	35
REMOTE CONTROL	36
Remote Control Setup	36
Remote Connection Step.....	37
Command Syntax	38
Error Messages	38
Command List	39
Command Details	40
FAQ	45
APPENDIX	46
Fuse Replacement	46
Specifications	47
Declaration of Conformity	49
INDEX	50

SAFETY INSTRUCTIONS

This chapter contains important safety instructions that you must follow when operating the GPD-3303 series and when keeping it in storage. Read the following before any operation to insure your safety and to keep the best condition for the GPD-3303 series.

Safety Symbols

These safety symbols may appear in this manual or on the GPD-3303 series.



WARNING

Warning: Identifies conditions or practices that could result in injury or loss of life.



CAUTION

Caution: Identifies conditions or practices that could result in damage to the GPD-3303 series or to other properties.



DANGER High Voltage



Attention Refer to the Manual



Protective Conductor Terminal



Earth (ground) Terminal

Safety Guidelines

General Guidelines

- Do not place any heavy object on the GPD-3303 series.
- Avoid severe impacts or rough handling that leads to damaging the GPD-3303 series.
- Do not discharge static electricity to the GPD-3303 series.
- Do not block or obstruct the cooling fan vent opening.
- Do not perform measurement at circuits directly connected to Mains (see note below).
- Do not disassemble the GPD-3303 series unless you are qualified as service personnel.

(Measurement categories) EN 61010-1:2001 specifies the measurement categories and their requirements as follows. The GPD-3303 series falls under category I.

- Measurement category IV is for measurement performed at the source of low-voltage installation.
- Measurement category III is for measurement performed in the building installation.
- Measurement category II is for measurement performed on the circuits directly connected to the low voltage installation.
- Measurement category I is for measurements performed on circuits not directly connected to Mains.

Power Supply • AC Input voltage: 100V/120V/220V/230V ±10%, 50/60Hz

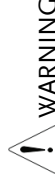

WARNING

- Connect the protective grounding conductor of the AC power cord to an earth ground, to avoid electrical shock.

Fuse

- Fuse type: 100V/120V: T6.3A/250V, 220V/230V: T3.15A/250V



WARNING

- Make sure the correct type of fuse is installed before power up.

- To ensure fire protection, replace the fuse only with the specified type and rating.
 - Disconnect the power cord before fuse replacement.
 - Make sure the cause of fuse blowout is fixed before fuse replacement.
-
- Cleaning the GPD-3303 series
- Disconnect the power cord before cleaning.
 - Use a soft cloth dampened in a solution of mild detergent and water. Do not spray any liquid.
 - Do not use chemicals or cleaners containing harsh products such as benzene, toluene, xylene, and acetone.
-
- Operation Environment
- Location: Indoor, no direct sunlight, dust free, almost non-conductive pollution (note below)
 - Relative Humidity: < 80%
 - Altitude: < 2000m
 - Temperature: 0°C to 40°C

(Pollution Degree) EN 61010-1:2001 specifies the pollution degrees and their requirements as follows. The GPD-3303 series falls under degree 2.

Pollution refers to "addition of foreign matter, solid, liquid, or gaseous (ionized gases), that may produce a reduction of dielectric strength or surface resistivity".

- Pollution degree 1: No pollution or only dry, non-conductive pollution occurs. The pollution has no influence.
- Pollution degree 2: Normally only non-conductive pollution occurs. Occasionally, however, a temporary conductivity caused by condensation must be expected.
- Pollution degree 3: Conductive pollution occurs, or dry, non-conductive pollution occurs which becomes conductive due to condensation which is expected. In such conditions, equipment is normally protected against exposure to direct sunlight, precipitation, and full wind pressure, but neither temperature nor humidity is controlled.

- Storage environment
- Location: Indoor
 - Relative Humidity: < 70%
 - Temperature: -10°C to 70°C

Power cord for the United Kingdom

When using the GPD-3303 series in the United Kingdom, make sure the power cord meets the following safety instructions.

NOTE: This lead/appliance must only be wired by competent persons

! WARNING: THIS APPLIANCE MUST BE EARTHED

IMPORTANT: The wires in this lead are coloured in accordance with the following code:

Green/ Yellow:	Earth
Blue:	Neutral
Brown:	Live (Phase)



As the colours of the wires in main leads may not correspond with the colours marking identified in your plug/appliance, proceed as follows:

The wire which is coloured Green & Yellow must be connected to the Earth terminal marked with the letter E or by the earth symbol  or coloured Green or Green & Yellow.

The wire which is coloured Blue must be connected to the terminal which is marked with the letter N or coloured Blue or Black.

The wire which is coloured Brown must be connected to the terminal marked with the letter L or P or coloured Brown or Red.

If in doubt, consult the instructions provided with the equipment or contact the supplier.

This cable/appliance should be protected by a suitably rated and approved HBC mains fuse: refer to the rating information on the equipment and/or user instructions for details. As a guide, cable of 0.75mm² should be protected by a 3A or 5A fuse. Larger conductors would normally require 13A types, depending on the connection method used.

Any moulded mains connector that requires removal / replacement must be destroyed by removal of any fuse & fuse carrier and disposed of immediately, as a plug with bared wires is hazardous if a engaged in live socket. Any re-wiring must be carried out in accordance with the information detailed on this label.

OVERVIEW

This chapter describes the GPD-3303 series in a nutshell, including its main features and front / rear panel introduction. After going through the overview, follow the Setup chapter (page19) to properly power up and set operation environment.

Introduction

Overview

GPD-3303, the regulated DC power supply series, are light weight, adjustable, multifunctional work stations. They have three independent outputs: two with adjustable voltage level and one with fixed level selectable from 2.5V, 3.3V and 5V. The GPD-3303 series can be used for logic circuits where various output voltage or current are needed, and for tracking mode definition systems where plus and minus voltages with insignificant error are required.

Independent / Tracking Series / Tracking Parallel

The three output modes of GPD-3303 series, independent, tracking series, and tracking parallel, can be selected through pressing the TRACKING key on the front panel. In the independent mode, the output voltage and current of each channel are controlled separately. The isolation degree, from output terminal to chassis or from output terminal to output terminal, is 300V. In the tracking modes, both the CH1 and CH2 outputs are automatically connected in series or parallel; no need to connect output leads. In the series mode, the output voltage is doubled; in the parallel mode, the output current is doubled.

Constant Voltage/ Constant Current Except for CH3, each output channel is completely transistorized and well-regulated, and works in constant voltage (CV) or constant current (CC) mode. Even at the maximum output current, a fully rated, continuously adjustable output voltage is provided. For a big load, the power supply can be used as a CV source; while for a small load, a CC source. When in the CV mode (independent or tracking mode), output current (overload or short circuit) can be controlled via the front panel. When in the CC mode (independent mode only), the maximum (ceiling) output voltage can be controlled via the front panel. The power supply will automatically cross over from CV to CC operation when the output current reaches the target value. The power supply will automatically cross over from CC to CV when the output voltage reaches the target value. For more details about CV/CC mode operation, see page18.

Automatic tracking mode

The front panel display (CH1, CH2) shows the output voltage or current. When operating in the tracking mode, the power supply will automatically connect to the auto-tracking mode.

Dynamic load

When used in audio production lines, the power supply will provide a continuous or dynamic load connector. When the connectors are connected to the position "ON", a stable DC current power will be provided for audio power amplifiers.

Series Lineup / Main Features

Series Lineup

Model	V Meter	A Meter	USB	Tracking Error
GPD-3303D	3 digit	3 digit	Yes	≤ 0.5% + 50mV of Master
GPD-3303S	5 digit	4 digit	Yes	≤ 0.5% + 10mV of Master

Main Features

- Low noise: Cooling fan controlled by Heatsink temperature
- Compact size, light weight

Operation

- Constant Voltage / Constant Current operation
- Tracking Series / Tracking parallel operation
- Output On/Off control
- 3 outputs: 30V/3A x 2, 2.5V/3.3V/5V/3A x 1
- Digital panel control
- 4 sets of panel setup save/recall
- Coarse and fine Voltage/Current control
- Software calibration
- Buzzer output
- Key lock function

Protection

- Overload protection
- Reverse polarity protection

Interface

- USB for remote control

Principle of Operation

Overview

The power supply consists of the following.

- AC input circuit
- Transformer
- Bias power supply including rectifier, filter, pre-regulator and reference voltage source
- Main regulator circuit including the main rectifier and filter, series regulator, current comparator, voltage comparator, reference voltage amplifier, remote device and relay control circuit

The block diagram below shows the circuit arrangement. The single phase input power is connected to the transformer through the input circuit. Details of each part are described in the next page.

Block diagram

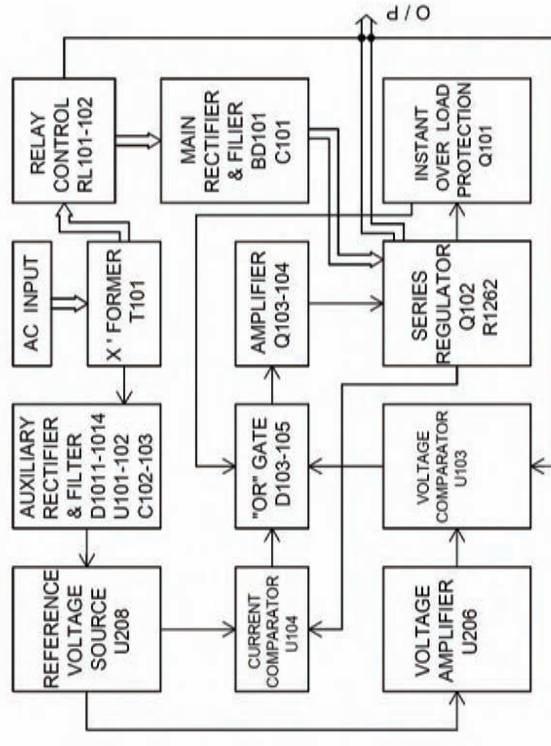

Rectifier The auxiliary rectifiers D1011 ~ D1014 provide bias voltage filtered by the capacitors C102 and C103, for the pre-regulators U101 and U102. They provide a regulated voltage for other modules.

Main Rectifier The main rectifier is a full wave bridge rectifier. It provides the power after the rectifier is filtered by the capacitor C101, and then regulated via a series-wound regulator, which is finally delivered to the output terminal.

Current Limiter U104 acts as a current limiter. When the current is over predetermined rating, U104 is activated and decreases the current. U208 provides a reference voltage. U206 is the inverter amplifier. U103 is a comparator amplifier which compares reference voltage and feedback voltage, and then delivers to Q103, Q104, which then calibrates the output voltage.

Overload When the unit is overloaded, Q107 activates to control the current magnitude of Q104, to limit the output current. The relay control circuit controls the power dissipation in the series-wound regulated circuit.

Front Panel Overview

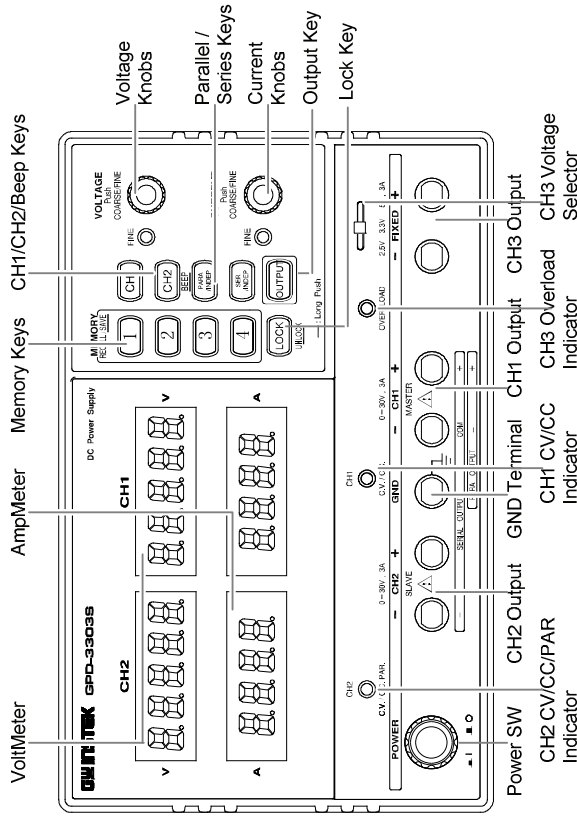

Display

VoltMeter	Displays CH1 or CH2 output voltage.	GPD-3303S (5 digits)	GPD-3303D (3 digits)
AmpMeter	Displays CH1 or CH2 output current.	GPD-3303S (4 digits)	GPD-3303D (3 digits)

Control Panel

Memory Keys

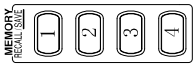

Saves or recalls panel settings. Four settings, 1 ~ 4, are available. For save/recall details, see page34.

CH1/CH2/Beep Keys



Selects the output channel for level adjustment. For level setting details, see page23. Pressing and holding CH2 key enables beep sound. For details, see page21.

Parallel/Series Keys



Activates Tracking Parallel operation or Tracking Series operation, For details, see page27.

Lock Key



Locks or unlocks the front panel settings. For details, see page22.

Output Key



Turns the output on or off.

Voltage Knobs

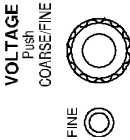

Adjusts the output voltage level for CH1 or CH2. Pressing the knob switches coarse and fine level setting.

Current Knobs

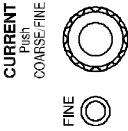

Adjusts the output current level for CH1 or CH2. Pressing the knob switches coarse and fine level setting.

Power Switch



Turns On or Off the main power. For power up sequence, see page19.

Terminals

Default Terminals

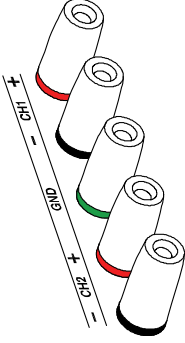

European Terminals

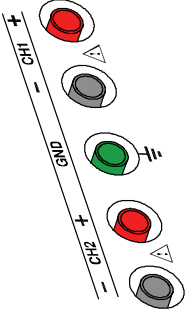

GND Terminal

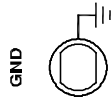

Accepts a grounding wire.

CH1 Output

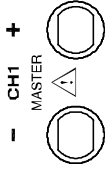

Outputs CH1 voltage and current.

CH1 CV/CC Indicator



Indicates CH1 Constant Voltage or Constant Current state.

CH2 Output

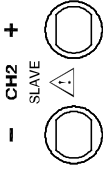

Outputs CH2 voltage and current.

CH2 CV/CC/PAR Indicator



Indicates CH2 Constant Voltage, Constant Current, or Tracking Parallel operation mode.

CH3 Output

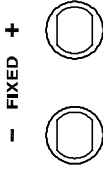

Outputs CH3 voltage and current.

CH3 Overload Indicator



Indicates when CH3 output current is overloaded.

CH3 Voltage Selector

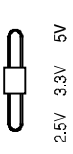

Selects CH3 output voltage: 2.5V, 3.3V, or 5V.

Rear Panel Overview

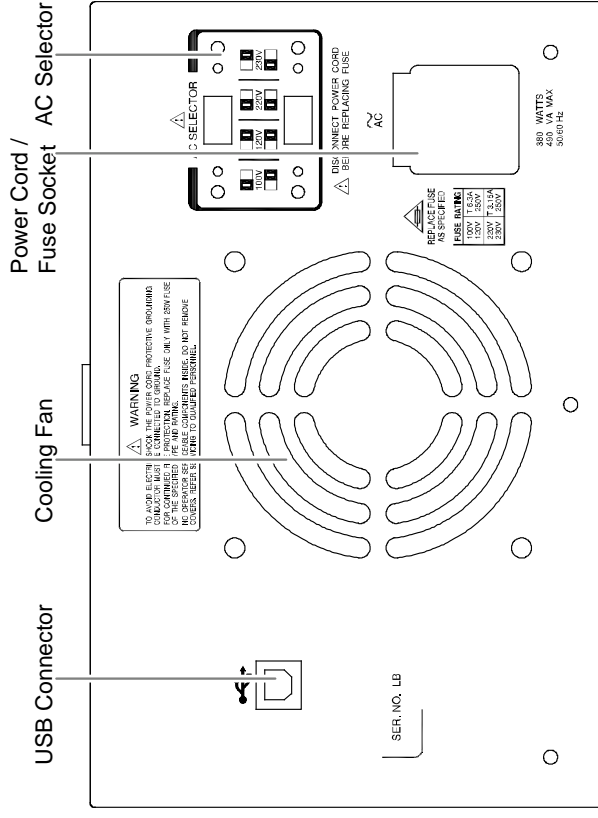

USB Connector



Accepts a USB slave connector for command-based remote control (page36).

Power Cord / Fuse Socket



The power cord socket accepts the AC mains: 115V / 230V, 50 / 60Hz. For power up details, see page19.

The fuse holder contains the AC main fuse. For fuse replacement details, see page46.

AC Selector

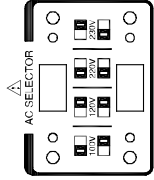

Selects AC voltage: 100V / 120V / 220V / 230V.

CV/CC Crossover Characteristics

Background

The GPD-3303 series automatically switches between constant voltage mode (CV) and constant current mode (CC), according to load condition.

CV mode

When the **current level is smaller than the output setting**, the GPD-3303 series operates in **Constant Voltage mode**. The indicator on the front panel turns green (C.V.) The Voltage level is kept at the setting and the Current level fluctuates according to the load condition until it reaches the output current setting.

CC mode

When the **current level reaches the output setting**, the GPD-3303 series starts operating in **Constant Current mode**. The indicator on the front panel turns red (C.C.) The Current level is kept at the setting but the Voltage level becomes lower than the setting, in order to suppress the output power level from overload. When the current level becomes lower than the setting, the GPD-3303 series goes back to the Constant Voltage mode.

Diagram

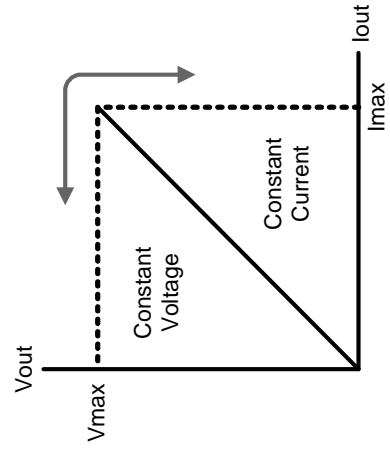

SETUP

This chapter describes how to properly power up and configure the GPD-3303 series before operation.

Power Up

Select AC voltage Before powering up the power supply, select the AC input voltage from the rear panel.

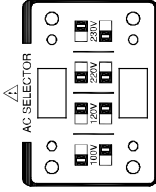

Connect AC power cord Connect the AC power cord to the rear panel socket.

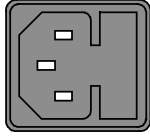

Power On Press the Power switch to turn on the power. The display shows the initialization screen with the model name, followed by the last recalled settings.

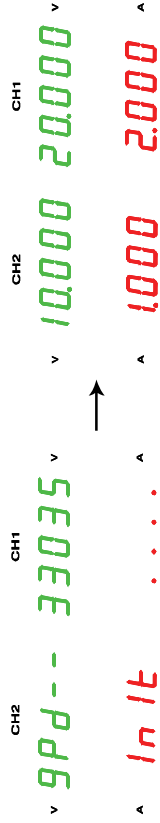

Power Off Press the Power switch again to turn off the power.



Load Cable Connection

- GTL-104**
1. Turn the terminal counterclockwise and loosen the screw.
 2. Insert the cable terminal.
 3. Turn the terminal clockwise and tighten the screw.

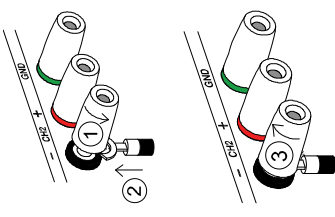

GTL-105 Insert the plug into the socket.

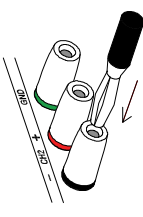

GTL-203, 204 Insert the plug into the terminal.

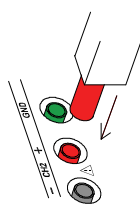

Wire type

When using load cables other than the attached, make sure they have enough current capacity for minimizing cable loss and load line impedance. Voltage drop across a wire should not exceed 0.5V. The following list is the wire current rating at 450A/cm².

Wire size (AWG)	Maximum current (A)
20	2.5
18	4
16	6
14	10
12	16

Output On/Off

Panel operation Pressing the Output key turns on all CH1/2/3 outputs.



The key LED also turns on. Pressing the Output key again turns the output and the key LED off.

Automatic output off Any of the following actions during output on automatically turns it off. They might involve sudden and harmful change in the output level.

- Change the operation mode between independent / tracking series / tracking parallel
- Recalling other setups from the memory
- Storing the setup into the memory

Beep On/Off

Panel operation By default, the beep sound is enabled. To turn off the beep, press the CH2 key for 2 seconds.



A beep comes out and the beep setting will be turned off. To enable the beep, press the CH2 key again for 2 seconds.

- List of beep** The following operations beep when the beep setting is on.
- Power on
 - Output on/off
 - INDEP – SER – PARA mode switching
 - Panel lock/unlock
 - Setup save/recall
 - CH1/CH2 output level knob switching
 - Voltage/current knob fine/coarse switching
 - Voltage/current level reaching minimum (zero) level

Front Panel Lock

Panel operation Press the LOCK key to lock the front panel key operation. The key LED turns on. To unlock, press the LOCK key for 2 seconds. The key LED also turns off.



Note The OUTPUT key is not affected by the lock operation.

OPERATION

CH1/CH2 Independent Mode

Background / Connection CH1 and CH2 outputs work independent of each other.

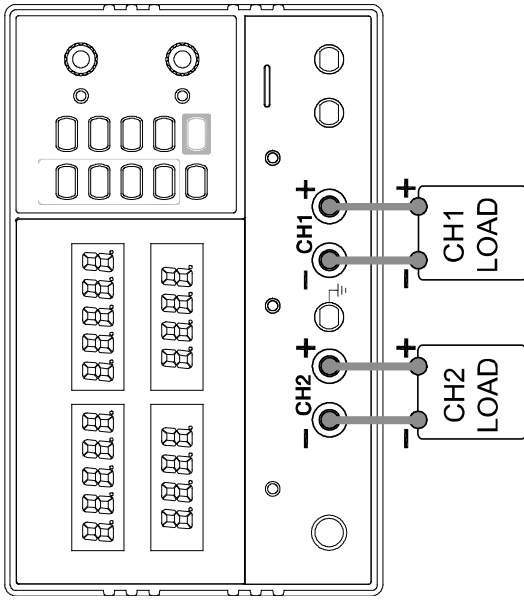

Output rating 0 ~ 30V/0~3A for each channel

Panel operation 1. Make sure the PARA/INDEP and SER/INDEP keys are turned off (the key LEDs are off).

2. Connect the load to the front panel terminals, CH1 +/ -, CH2 +/ -.

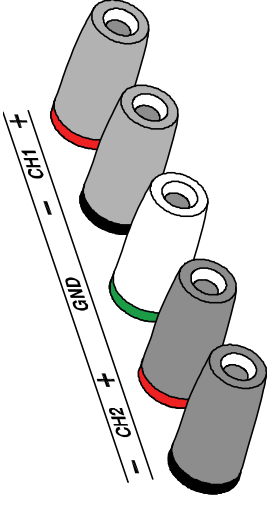

Note: this diagram shows non-European terminals.

3. Set the CH1 output voltage (For CH1) and current. Press the CH1 key (LED turns on) and then use the Voltage and Current knob. By default, the Voltage and Current knob work in the coarse mode. To activate the fine mode, press the knob to turn the FINE LED on.

- Coarse: 0.1V or 0.1A @ rotation click
- Fine: the smallest digit @ rotation click

4. Repeat the above settings for the CH2.

5. To turn on the output, press the output key. The key LED turns on and the CH1 / CH2 indicator shows the output mode, CV or CC.

CH3 Independent Mode

Background / Connection

The CH3 rating is 2.5V/3.3V/5V, 3A fixed. It works independently from CH1 and CH2, regardless of their modes.

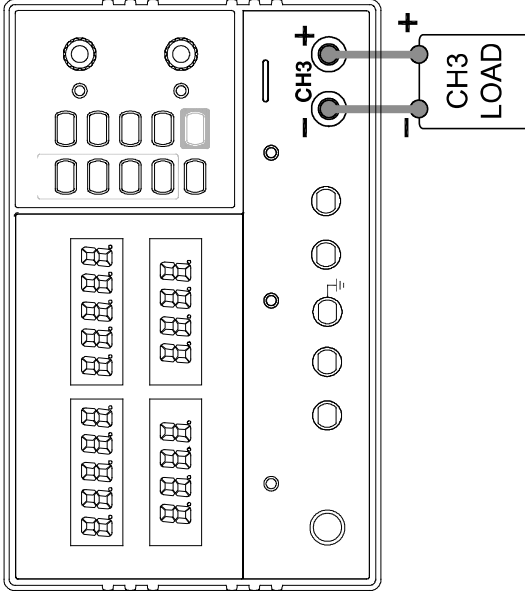

Output rating 2.5V/3.3V/5V, 3A fixed

No Tracking Series/Parallel CH3 does not have tracking series/parallel mode. Also, CH3 output is not affected by CH1 and CH2 modes.

Panel operation 1. Connect the load to the front panel CH3 +/- terminal. (the diagram shows non-European terminals)

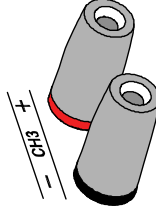

2. Select the output voltage, 2.5V/3.3V/5V using the CH3 voltage selector key.

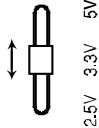

3. To turn on the output, press the output key. The key LED turns on.



CV → CC

When the output Current level exceeds 3A, the overload indicator turns red and CH3 operation mode switches from Constant Voltage to Constant Current.



Note: "overload" in this case does not mean an abnormal operation.

CH1/CH2 Tracking Series Mode

Background

Tracking series operation doubles the Voltage capacity of the GPD-3303 series by internally connecting CH1 (Master) and CH2 (Slave) in serial and combining the output to a single channel. CH1 (Master) controls the combined Voltage output level.

The following describes two type of configurations depending on the common ground usage.

Tracking series without common terminal

Connection

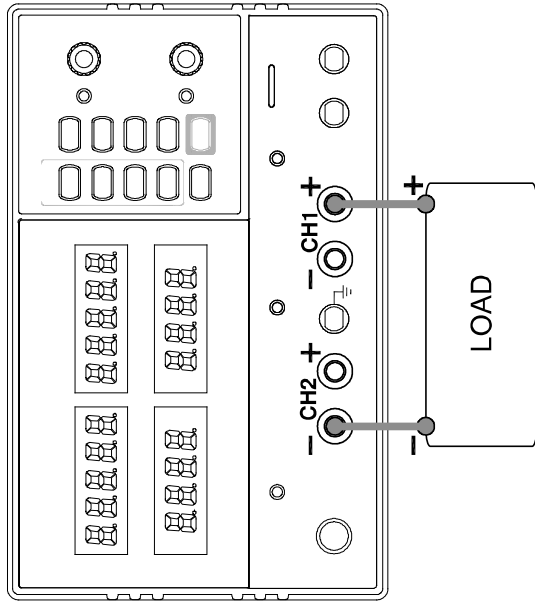

Output rating 0 ~ 60V/0 ~ 3A

1. Press the SER/INDEP key to activate the tracking series mode. The key LED turns on.



2. Connect the load to the front panel terminals, CH1+ & CH2- (Single supply).

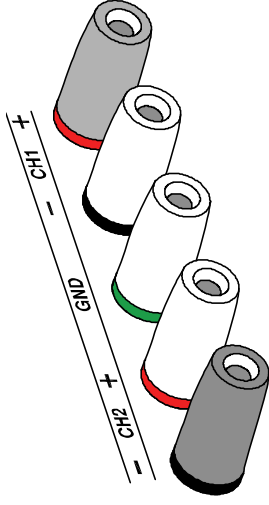

Note: this diagram shows non-European terminals.

3. Press the CH2 key (LED turns on) and then use the Current knob to set the CH2 output current to the maximum level (3.0A). By default, the Voltage and Current knob work in the coarse mode. To activate the fine mode, press the knob to turn the FINE LED on.

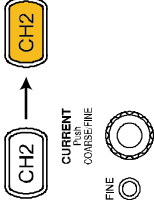

(Fine control)

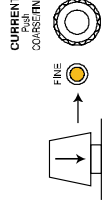

- Coarse: 0.1V or 0.1A @ rotation click
- Fine: the smallest digit @ rotation click

4. Press the CH1 key (LED turns on) and then use the Voltage and Current knob to set the output voltage and current level.

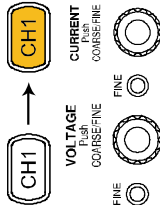

5. To turn on the output, press the output key. The key LED turns on.

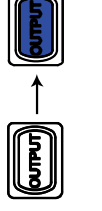

6. Refer to the CH1 (Master) meter and indicator for the output setting level and CV/CC status.

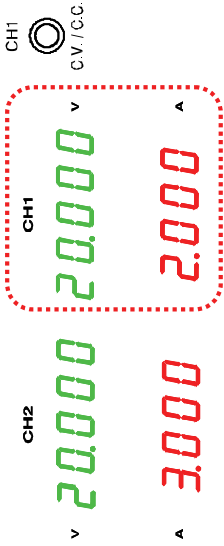

Voltage level Double the reading on the CH1 Voltage meter. In the above case, the actual output is 20.0 x 2 = 40.0V.

Current level CH1 meter reading shows the output Current. In the above case, 2.000A. (CH2 Current control must be in the Maximum position=3.0A).

Tracking series with common terminal

Connection

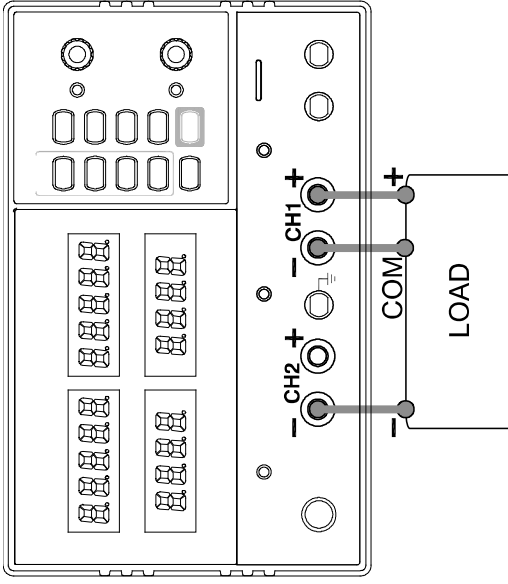

Output rating 0~30V/0~3A for CH1 ~ COM
0~-30V/0~3A for CH2 ~ COM

1. Press the SER/INDEP key to activate the tracking series mode. The key LED turns on.



2. Connect the load to the front panel terminals, CH1+ & CH2-. Use the CH1 (-) terminal as the common line connection.

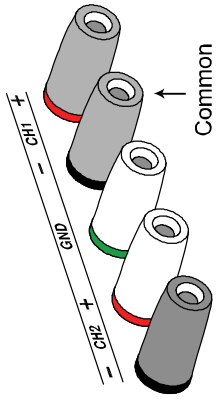

Note: this diagram shows non-European terminals.

3. Press the CH1 key (LED turns on) and use the Voltage knob to set the master & slave output voltage (the same level for both channels). By default, the Voltage and Current knob work in the coarse mode. To activate the fine mode, press the knob to turn the FINE LED on.

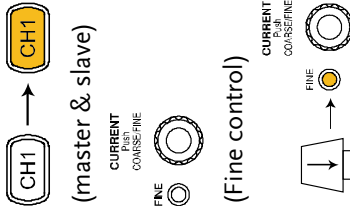

- Coarse: 0.1V or 0.1A @ rotation click
- Fine: the smallest digit @ rotation click

4. Use the Current knob to set the master output current.



5. To turn on the output (and LED), press the output key.

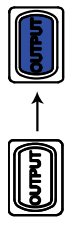

6. For the master (CH1) output level and CV/CC status, refer to the CH1 meter and indicator.

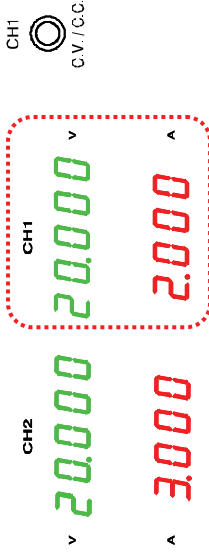

- Master (CH1) voltage level
 Master (CH1) current level
- CH1 meter reading shows the output voltage. In the above case, 20.0V.
 CH1 meter reading shows the output current. In the above case, 2.000A.

7. Press the CH2 key (LED turns on) and use the Current knob to set the slave output current.

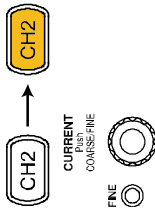

8. For the slave (CH2) output level and CV/CC status, refer to the CH1/CH2 meter and CH2 indicator.

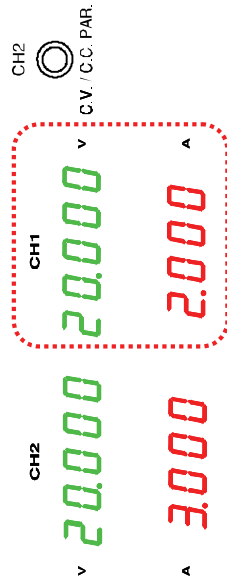

- Slave (CH2) voltage level
 Slave (CH2) current level
- The CH2 meter reading shows the output voltage. In the above case, 20.0V.
 The CH2 meter reading shows the output current. In the above case, 3.000A.

CH1/CH2 Tracking Parallel Mode

Background / Connection

Tracking parallel operation doubles the current capacity of the GPD-3303 series by internally connecting CH1 and CH2 in parallel and combining the output to a single channel. CH1 controls the combined output.

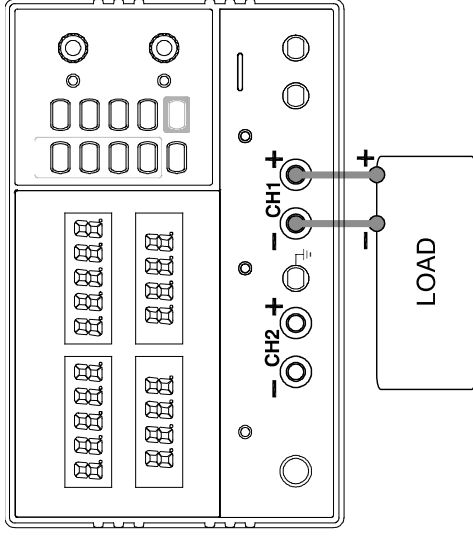

Output rating 0 ~ 30V/0 ~ 6A

1. Press the PARA/INDEP key to activate the tracking parallel mode. The key LED turns on.

2. Connect the load to the CH1 +/- terminals.

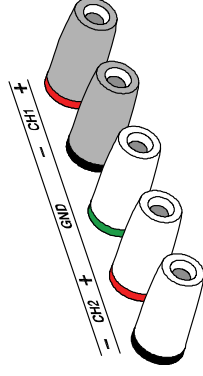

Note: this diagram shows non-European terminals.

3. To turn on the output, press the output key. The key LED turns on.

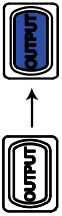

4. The CH2 indicator turns red, indicating tracking parallel (PARA) mode.

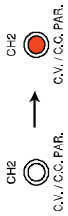

5. Press the CH1 key (LED turns on) and then use the Voltage and Current knob to set the output voltage and current. The CH2 output control is disabled. By default, the Voltage and Current knob work in the coarse mode. To activate the fine mode, press the knob to turn the FINE LED on.

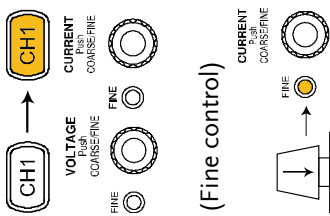

6. For the output level and CV/CC status, refer to the CH1 meter and indicator.

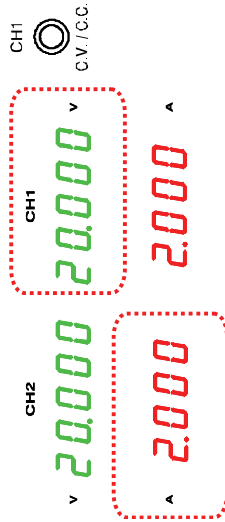

Voltage level The CH1 meter reading shows the output voltage. In the above case, 20.0V.

Current level Double the amount of CH1 current meter reading. In the above case, $2.0A \times 2 = 4.0A$.

SAVE/RECALL SETUP

Save Setup

Background The front panel settings can be stored into one of the four internal memories.

Contents The following list shows the setup contents.

- Independent / tracking series / tracking parallel mode
- CH1/CH2 knob selection
- Fine/coarse editing mode
- Output voltage/current level

The following settings are always saved as "off".

- Output on/off
- Front panel lock/unlock

Panel operation

Press one of the 1~4 Memory keys for 2 seconds, for example memory 1. The panel settings are saved in memory 1 and the key LED turns on. When the panel settings are modified, the LED turns off.

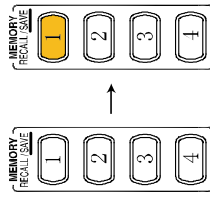

Note When a setting is stored, the output automatically turns off.

Recall Setup

Background	The front panel settings can be recalled from one of the four internal memories.
Contents	<p>The following list shows the setup contents.</p> <ul style="list-style-type: none"> Independent / tracking series / tracking parallel mode CH1/CH2 knob selection Fine/coarse editing mode Output voltage/current level <p>The following settings are always recalled as "off".</p> <ul style="list-style-type: none"> Output on/off Front panel lock/unlock

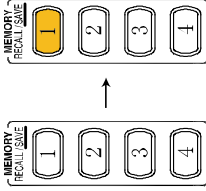
Panel operation	<p>Press one of the 1~4 Memory keys, for example memory 1. The panel settings saved in memory 1 are recalled. The key LED turns on. When the panel settings are modified, the LED turns off.</p> 
-----------------	--

Note	When a setting is recalled, the output automatically turns off.
------	---

REMOTE CONTROL

Remote Control Setup

Background	The GPD-3303D and GPD-3303S are capable of being remotely controlled via the USB connection.
Interface	 <p>USB slave port, rear panel</p>
COM setting	<p>Set up the COM port inside the PC according to the following list.</p> <ul style="list-style-type: none"> Baud rate: 9600 Parity bit: None Data bit: 8 Stop bit: 1 Data flow control: None

Functionality check	<p>Run this query command via the terminal application such as MTTY (Multi-threaded TTY).</p> <p>*IDN?</p> <p>This should return the identification information: Manufacturer, model name, serial number, firmware version.</p> <p>GW INSTEK, GPD-3303x, SN: xxxxxxxx, Vx.xx</p>
---------------------	--

Remote Connection Step

Entering the remote control mode

1. Connect the USB cable to the slave port.
2. The connection will be automatically established, and the front panel shows "USB...YES" message.

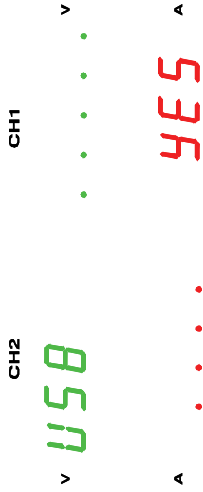

3. The power supply also automatically enters the lock state (the Lock key will become activated).



Leaving the remote control mode

1. Disconnect the USB cable from the rear.
2. The display shows "USB...NO" message.

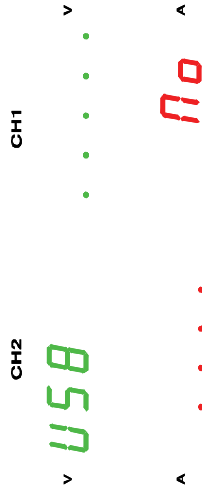

3. Unlock the power supply by keep pressing the Lock key until it turns off.



4. The power supply goes back to the local operation mode.

Command Syntax

Command format **ISET<X>:<NR2>**

The diagram shows the command format 'ISET<X>:<NR2>' with four numbered parts: 1: command header, 2: output channel, 3: separator, and 4: parameter.

Output channel	1 (CH1) or 2 (CH2)
Parameter	1 (CH1) or 2 (CH2)
Type	Description
<Boolean>	boolean logic 0 (off), 1 (on)
<NR1>	integers 0, 1, 2, 3
<NR2>	decimal numbers 0.1, 3.14, 8.5

Note Commands are not case-sensitive.

Error Messages

The following error messages might appear when the GPS-3303D or 3303S cannot accept the command.

Message contents	Descriptions
Program mnemonic too long	The command length must be 15 characters or less.
Invalid character	Invalid characters, such as symbols, are entered. Example: VOUT#
Missing parameter	The parameter is missing from the command. Example: VSET: (should have a number)
Data out of range	The entered value exceeds the specification. Example: VSET:33 (should be ≤ 32V)
Command not allowed	The entered command is not allowed in the circumstance. Example: trying to set CH2 output while in the tracking mode.
Undefined header	The entered command does not exist, or the syntax is wrong.

Command List

- Detailed descriptions of each command start from the next page.
- The “HELP” command shows all the below commands and their meanings, except for the HELP command itself.

ISET<X>:<NR2>	Sets the output current.
ISET<X>?	Returns the output current setting.
VSET<X>:<NR2>	Sets the output voltage.
VSET<X>?	Returns the output voltage setting.
IOUT<X>?	Returns the actual output current.
VOUT<X>?	Returns the actual output voltage.
TRACK<NR1>	Selects the operation mode.
BEEP<BOOLEAN>	Turn on or off the beep.
OUT<BOOLEAN>	Turn on or off the output.
STATUS?	Returns the GPS-3303D or GPS-3303S status.
*IDN?	Returns the GPS-3303D or GPD-3303S identification.
RCL<NR1>	Recalls a panel setting.
SAV<NR1>	Saves the panel setting.
HELP?	Shows the command list.
ERR?	Returns the instrument error messages.

Command Details

ISET<X>:<NR2>

Description	Sets the output current.		
Panel operation	See page23		
Response time	Minimum 70ms		
Example	ISET1:2.234	Sets the CH1 output current to 2.234A (for GPD-3303S)	
	ISET1:2.23	Sets the CH1 output current to 2.23A (for GPD-3303D)	

ISET<X>?

Description	Returns the output current setting.		
Panel operation	See page23		
Response time	Minimum 80ms		
Example	ISET1?	Returns the CH1 output current setting	

VSET<X>:<NR2>

Description	Sets the output voltage.		
Panel operation	See page23		
Response time	Minimum 70ms		
Example	VSET1:20.345	Sets the CH1 voltage to 20.345V (for GPD-3303S)	
	VSET1:20.3	Sets the CH1 voltage to 20.3V (for GPD-3303D)	

VSET<X>?

Description Returns the output voltage setting.

Response time Minimum 80ms

Example VSET1? Returns the CH1 voltage setting

IOUT<X>?

Description Returns the actual output current.

Response time Minimum 80ms

Example IOUT1? Returns the CH1 output current

VOUT<X>?

Description Returns the actual output voltage.

Panel operation See page23

Response time Minimum 80ms

Example VOUT1? Returns the CH1 output voltage

TRACK<NR1>

Description Selects the operation mode: independent, tracking series, or tracking parallel.

Panel operation See page27

NR1
0: Independent
1: Tracking series
2: Tracking parallel

Response time Minimum 70ms

Example TRACK0 Selects the independent mode

BEEP<Boolean>

Description Turns the beep on or off.

Panel operation See page21

Response time Minimum 70ms

Example BEEP1 Turns on the beep

OUT<Boolean>

Description Turns on or off the output.

Panel operation See page21

Response time Minimum 70ms

Example OUT1 Turns on the output

STATUS?

Description Returns the GPD-3303D or GPD-3303S status.

Response time Minimum 400ms

Contents 8 bits in the following format

Bit	Item	Description
0	CH1	0=CC mode, 1=CV mode
1	CH2	0=CC mode, 1=CV mode
2, 3	Tracking	01=Independent, 11=Tracking series, 10=Tracking parallel
4	Beep	0=Off, 1=On
5	N/A	N/A
6	Output	0=Off, 1=On
7	N/A	N/A

***IDN?**

Description	Returns the GPD-3303D or GPD-3303S identification.
Response time	Minimum 300ms
Contents	GW INSTEK,GPD-3303x,SN: xxxxxxxx, Vx.xx (Manufacturer, model name, serial number, firmware version)

RCL<NR1>

Description	Recalls a panel setting.
Panel operation	See page35
NR1	1 - 4: Memory 1 to 4
Response time	Minimum 70ms
Example	RCL1 Recalls the panel setting stored in memory 1

SAV<NR1>

Description	Stores the panel setting.
Panel operation	See page34
NR1	1 - 4: Memory 1 to 4
Response time	Minimum 70ms
Example	SAV1 Stores the panel setting in memory 1

HELP?

Description	Shows the command list.
Response time	Minimum 1000ms

Contents

ISET<x><NR2>	Sets the value of current.
VSET<x><NR2>	Sets the value of voltage. x:1=CH1,2=CH2.
ISET<x>?	Return the value of current.
VSET<x>?	Return the value of voltage.
IOUT<x>?	Returns actual output current
VOUT<x>?	Returns actual output voltage.
TRACK<NR1>	Sets the output of the power supply working on independent or tracking mode. NR1:0=INDEP,1=SER,2=PARA;
BEEP<Boolean>	Sets the BEEP state on or off.
OUT<Boolean>	Sets the output state on or off.
STATUS?	Returns the power supply state.
bit0:(CH1)0=CC,1=CV;bit1:(CH2)0=CC,1=CV;bit23=(TRACK)01=INDEP,1=SER,10=PARA;bit4:(BEEP)0=OFF,1=ON;bit6:(OUT)0=OFF,1=ON;	
*IDN?	Returns instrument identification.
RCL<NR0>	Recall the setting data from the memory which previous saved.
SAV<NR0>	Saves the setting data to memory.
NR0:1=Memory1,2=Memory2,3=Memory3,4=Memory4;	
ERR?	Returns instrument error messages.

ERR?

Description	Checks the error status of the instrument and returns the last error message.
Response time	Minimum 70ms
Contents	See page38 for the list of error messages.

FAQ

Q1. I pressed the panel lock key but the output still turns on/off.

A1. The output key is not affected by the panel lock key operation, for ensuring safety.

Q2. The CH3 overload indicator turned on – is this an error?

A2. No, it simply means that the CH3 output current reached the maximum 3.0A and the operation mode turned from CV (constant voltage) to CC (constant current). You can continue using the power supply, although reducing the output load is recommended.

Q3. The specifications does not match the real accuracies.

A3. Make sure that the power supply is powered on for at least 30 minutes, within +20°C – +30°C.

Q4. The internal memory is not recording the panel setting correctly – the output should be on.

A4. The output is always stored or recalled as “off” to ensure safety.

For more information, contact your local dealer or GWINSTEK at www.gwinstek.com.tw / marketing@goodwill.com.tw.

APPENDIX

Fuse Replacement

Steps

1. Take off the power cord and remove the fuse socket using a minus driver.

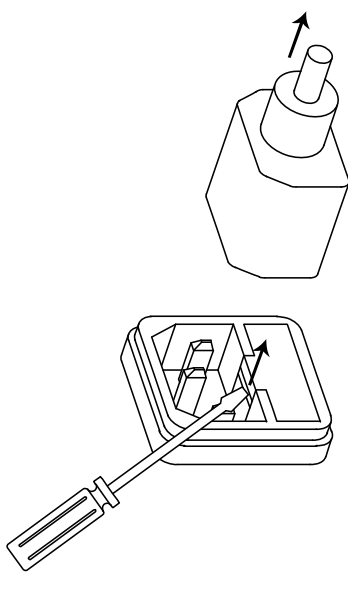

2. Replace the fuse in the holder.

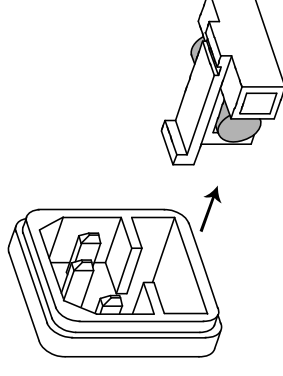

Rating

- 100V/120V:T6.3A/250V
- 220V/230V:T3.15A/250V

Specifications

The specifications apply when the GPD-3303 series are powered on for at least 30 minutes under +20°C – +30°C.

Output Ratings	CH1/CH2 Independent	0 ~ 30V / 0 ~ 3A
	CH1/CH2 Series	0 ~ 60V / 0 ~ 3A
Voltage Regulation	CH1/CH2 Parallel	0 ~ 30V / 0 ~ 6A
	CH3	2.5V/3.3V/5.0V, 3A
Voltage Regulation	Line	≤ 0.01% + 3mV
	Load	≤ 0.01% + 3mV (rating current ≤ 3A) ≤ 0.02% + 5mV (rating current > 3A)
Ripple & Noise		≤ 1mVrms (5Hz ~ 1MHz)
Recovery Time		≤ 100μs (50% load change, minimum load 0.5A)
Temperature Coefficient		≤ 300ppm/°C
Current Regulation	Line	≤ 0.2% + 3mA
	Load	≤ 0.2% + 3mA
Ripple & Noise		≤ 3mArms
	Regulation	Line ≤ 5mV Load ≤ 15mV
CH3 Specification		Ripple & Noise ≤ 2mVrms
	Tracking Error	≤ 0.5%+10mV of Master (GPD-3303S) ≤ 0.5%+50mV of Master (GPD-3303D)
Tracking Operation	Parallel Regulation	Line: ≤ 0.01% + 3mV Load: ≤ 0.01% + 3mV (rating current ≤ 3A) Load: ≤ 0.02% + 5mV (rating current > 3A)
	Series Regulation	Line: ≤ 0.01% + 5mV Load: ≤ 300mV
Meter Resolution	GPD-3303D	Voltage: 100mV Current: 10mA

	GPD-3303S	Voltage: 1mV Current: 1mA
A Meter	GPD-3303D	3.2A full scale, 3 digits 0.5" LED display
	GPD-3303S	3.2A full scale, 4 digits 0.4" LED display
V Meter	GPD-3303D	32V full scale, 3 digits 0.5" LED display
	GPD-3303S	32V full scale, 5 digits 0.4" LED display
Program Accuracy	GPD-3303D	± (0.5% of reading + 2digits) ± (0.5% of reading + 2digits)
	GPD-3303S	± (0.03% of reading + 10mV) ± (0.3% of reading + 10mA)
Readback Accuracy	GPD-3303D	± (0.5% of reading + 2digits) ± (0.5% of reading + 2digits)
	GPD-3303S	± (0.03% of reading + 10mV) ± (0.3% of reading + 10mA)
Insulation	Chassis and Terminal	20MΩ or above (DC 500V)
	Chassis and AC cord	30MΩ or above (DC 500V)
Operation Environment	Indoor use, Altitude: ≤ 2000m Ambient temperature 0 ~ 40°C Relative humidity ≤ 80%	
	Installation category: II, Pollution degree: 2	
Storage Environment		Ambient temperature -10 ~ 70°C
		Relative humidity ≤ 70%
Power Source		AC 100V/120V/220V/230V±10%, 50/60Hz
Accessories		User manual x1 Test lead GTL-104 x 2, GTL-105 x 1 (Europe) Test lead GTL-203 x 1, GTL-204 x 2
Dimensions		210 (W) x 130 (H) x 265 (D) mm
Weight		Approx. 7kg
Options		
USB cable	GTL-246	USB 2.0, A-B type

Declaration of Conformity

We
GOOD WILL INSTRUMENT CO., LTD.
 (1) No.7-1, Jhongsing Rd., Tucheng City, Taipei County, Taiwan
 (2) No. 69, Lu San Road, Suzhou City (Xin Qu), Jiangsu Sheng, China
 declare, that the below mentioned product
Type of Product: Power Supply
Model Number: GPD-3303D/GPD-3303S
 are herewith confirmed to comply with the requirements set out in the
 Council Directive on the Approximation of the Law of Member States
 relating to Electromagnetic Compatibility (2004/108/EC, 89/336/EEC,
 92/31/EEC, 93/68/EEC) and Low Voltage Directive (73/23/EEC,
 93/68/EEC).

For the evaluation regarding the Electromagnetic Compatibility and
 Low Voltage Directive, the following standards were applied:

© EMC

EN 61326-1: 2006 Electrical equipment for measurement, control and laboratory use -- EMC requirements	
Conducted Emission	Class A
Radiated Emission	Electrostatic Discharge EN 61000-4-2: 1995 + A1:1998 + A2:2001
EN 55011: 1998 + A1:1999 + A2:2002	Radiated Immunity EN 61000-4-3: 2002 + A1:2002
Current Harmonics	Electrical Fast Transients EN 61000-4-4: 2004
EN 61000-3-2: 2000 + A2:2005	Surge Immunity EN 61000-4-5: 1995 + A1:2001
Voltage Fluctuations	Conducted Susceptibility EN 61000-4-6: 1996 + A1:2001
EN 61000-3-3: 1995 + A1:2001	Power Frequency Magnetic Field EN 61000-4-8: 1993 + A1:2001
-----	Voltage Dip/ Interruption EN 61000-4-11: 2004

© Safety

Low Voltage Equipment Directive 73/23/EEC, 93/68/EEC
Safety Requirements
IEC/EN 61010-1: 2001

INDEX

automatic out off	21	lock (manual).....	22
banana plug.....	20	overview	14
beep setting		fuse	
contents.....	21	rating	46
manual	21	replacing	46
remote control.....	42	safety instruction	6
caution symbol	5	GPD series	
cleaning the instrument.....	7	block diagram.....	12
COM setting, remote control		dynamic load.....	10
.....	36	lineup.....	11
command list	39	list of features.....	11
recalling the list.....	43	operation theory.....	12
common terminal, tracking		technology overview	9
series.....	27	ground symbol	5
cooling fan.....	17	identification information...	43
safety instruction.....	6	load connection	20
CV/CC		operation mode	
CH1/CH2 indicator	24	independent.....	23
CH3 indicator.....	26	remote control	41
operation theory	10, 18	specifications	47
EN61010		tracking parallel.....	32
declaration of conformity	49	tracking series.....	27
measurement category	6	output current setting	
pollution degree	7	manual.....	24
EN61326-1	49	remote control	40
environment		output on/off	
operation.....	7	FAQ	45
specification	48	manual.....	21
storage.....	8	remote	42
error messages, remote		output voltage setting	
control.....	38, 44	manual.....	24
front panel		remote control	40

overload indicator	26	interface	36
power supply		save settings	
safety instruction	6	manual	34
setup	19	remote	43
socket overview	17	service operation	
specification	48	about disassembly	6
protective ground symbol	5	contact	45
rear panel overview	17	status, instrument	42
recall settings		tracking mode	
manual	35	operation theory	9
remote	43	UK power cord	8
remote control		USB interface	36
command syntax	38	warning symbol	5
connection test	36	wire, load	20
error messages	38		