

# Battery Meter

GBM-3080/3300

---

**USER MANUAL**

**V1.0**



ISO-9001 CERTIFIED MANUFACTURER

**GW INSTEK**

This manual contains proprietary information, which is protected by copyright. All rights are reserved. No part of this manual may be photocopied, reproduced or translated to another language without prior written consent of Good Will company.

The information in this manual was correct at the time of printing. However, Good Will continues to improve products and reserves the rights to change specification, equipment, and maintenance procedures at any time without notice.

**Good Will Instrument Co., Ltd.**  
**No. 7-1, Jhongsing Rd., Tucheng Dist., New Taipei City 236, Taiwan.**

# Table of Contents

|  |           |
|--|-----------|
| <b>SAFETY INSTRUCTIONS</b> .....                 | <b>5</b>  |
| <b>GETTING STARTED</b> .....                     | <b>11</b> |
| GBM Series Overview .....                        | 12        |
| Appearance .....                                 | 17        |
| Set Up .....                                     | 20        |
| <b>SETTING UP</b> .....                          | <b>24</b> |
| Setting up the measurement item .....            | 25        |
| Setting up comparator.....                       | 40        |
| Setting USB disk.....                            | 44        |
| <b>MEASUREMENT</b> .....                         | <b>48</b> |
| How to enter [MEAS DISPLAY] page .....           | 49        |
| Setting up measurement function .....            | 51        |
| Setting up corresponding measurement range ..... | 52        |
| Setting up measurement speed .....               | 55        |
| <b>DATA LOGGING AND STATISTICS</b> .....         | <b>56</b> |
| Data logging function.....                       | 57        |
| Statistics function .....                        | 66        |
| <b>SYSTEM CONFIGURATION</b> .....                | <b>74</b> |
| System configuration page .....                  | 75        |
| System info page .....                           | 86        |
| <b>OTHER FUNCTIONS</b> .....                     | <b>88</b> |
| Offsetting before short-circuit test .....       | 89        |
| Short-circuit test .....                         | 94        |
| Handler Overview.....                            | 97        |

|   |            |
|---|------------|
| <b>REMOTE CONTROL</b> .....             | <b>104</b> |
| Configure Interface.....                | 105        |
| <b>COMMAND OVERVIEW</b> .....           | <b>118</b> |
| Command Syntax.....                     | 119        |
| Command List.....                       | 123        |
| <b>APPENDIX</b> .....                   | <b>177</b> |
| GBM-3300 Factory Default Settings ..... | 178        |
| Specifications .....                    | 180        |
| Dimensions .....                        | 183        |
| Declaration of Conformity .....         | 184        |

# S SAFETY INSTRUCTIONS

This chapter contains important safety instructions that you must follow during operation and storage. Read the following before any operation to ensure your safety and to keep the instrument in the best possible condition.

## Safety Symbols

These safety symbols may appear in this manual or on the instrument.

---



WARNING

Warning: Identifies conditions or practices that could result in injury or loss of life.



CAUTION

Caution: Identifies conditions or practices that could result in damage to the GBM-3000 series or to other properties.



DANGER High Voltage



Attention Refer to the Manual



Protective Conductor Terminal



Earth (ground) Terminal



Do not dispose electronic equipment as unsorted municipal waste. Please use a separate collection facility or contact the supplier from which this instrument was purchased.

## Safety Guidelines

---

General Guideline • Make sure that the voltage input level does not exceed DC330V, 1A (for GBM-3300).  
DC808V, 1A (for GBM-3080).



CAUTION

- AC voltage input is strictly prohibited.
- Do not place any heavy object on the instrument.
- Avoid severe impact or rough handling that can lead to damaging the instrument.
- Do not discharge static electricity to the instrument.
- Use only mating connectors, not bare wires, for the terminals.
- Do not perform measurement at the source of a low-voltage installation or at building installations (Note below).
- Do not disassemble the instrument unless you are qualified as service personnel.
- Remove all test leads before disconnecting the mains power cord from the socket.
- If the equipment is used in a manner not specified by the manufacturer, the protection provided by the equipment may be impaired.
- The device should be placed in a place where the plug connected to it can be removed easily.

(Note) EN 61010-1:2010 specifies the measurement categories and their requirements as follows. The GBM-3000 SERIES falls under category II 300V.

- Measurement category IV is for measurement performed at the source of low-voltage installation.
- Measurement category III is for measurement performed in the building installation.
- Measurement category II is for measurement performed on the circuits directly connected to the low voltage installation.

- Power Supply
- AC Input voltage: 100-240 VAC 50/60Hz
-  WARNING
- The power supply voltage should not fluctuate more than 10%.
  - Connect the protective grounding conductor of the AC power cord to an earth ground, to avoid electrical shock.
- 

- Cleaning the Instrument
- Disconnect the power cord before cleaning.
  - Use a soft cloth dampened in a solution of mild detergent and water. Do not spray any liquid.
  - Do not use chemicals containing harsh material such as benzene, toluene, xylene, and acetone.
- 

- Operation Environment
- Location: Indoor, no direct sunlight, dust free, almost non-conductive pollution (Note below)
  - Temperature: 0°C to 40°C
  - Humidity:
    - < 30°C: < 80%RH(non-condensing);
    - 30°C~40°C: <70%RH(non-condensing);
    - >40°C: <50%RH (non-condensing)
  - Altitude: <2000m
- (Note) EN 61010-1:2010 specifies the pollution degrees and their requirements as follows. The GBM-3000 SERIES falls under degree 2.
- Pollution refers to “addition of foreign matter, solid, liquid, or gaseous (ionized gases), that may produce a reduction of dielectric strength or surface resistivity”.
  - Pollution degree 1: No pollution or only dry, non-conductive pollution occurs. The pollution has no influence.
  - Pollution degree 2: Normally only non-conductive pollution occurs. Occasionally, however, a temporary conductivity caused by condensation must be expected.
  - Pollution degree 3: Conductive pollution occurs, or dry, non-conductive pollution occurs which becomes conductive due to condensation which is expected. In such conditions, equipment is normally protected against exposure to direct sunlight, precipitation, and full wind pressure, but neither temperature nor humidity is controlled.
-



Storage  
environment

- Location: Indoor
  - Temperature: -10°C to 70°C
  - Humidity: <80%RH(non-condensing)
- 

Disposal



Do not dispose this instrument as unsorted municipal waste. Please use a separate collection facility or contact the supplier from which this instrument was purchased. Please make sure discarded electrical waste is properly recycled to reduce environmental impact.

## Power cord for the United Kingdom

When using the unit in the United Kingdom, make sure the power cord meets the following safety instructions.

**NOTE:** This lead/appliance must only be wired by competent persons



**WARNING: THIS APPLIANCE MUST BE EARTHED**

**IMPORTANT:** The wires in this lead are coloured in accordance with the following code:

|                |              |
|----------------|--------------|
| Green/ Yellow: | Earth        |
| Blue:          | Neutral      |
| Brown:         | Live (Phase) |



As the colours of the wires in main leads may not correspond with the coloured marking identified in your plug/appliance, proceed as follows:

The wire which is coloured Green & Yellow must be connected to the Earth terminal marked with either the letter E, the earth symbol (⊕) or coloured Green/Green & Yellow.

The wire which is coloured Blue must be connected to the terminal which is marked with the letter N or coloured Blue or Black.

The wire which is coloured Brown must be connected to the terminal marked with the letter L or P or coloured Brown or Red.

If in doubt, consult the instructions provided with the equipment or contact the supplier.

This cable/appliance should be protected by a suitably rated and approved HBC mains fuse: refer to the rating information on the equipment and/or user instructions for details. As a guide, a cable of 0.75mm<sup>2</sup> should be protected by a 3A or 5A fuse. Larger conductors would normally require 13A types, depending on the connection method used.

Any exposed wiring from a cable, plug or connection that is engaged in a live socket is extremely hazardous. If a cable or plug is deemed hazardous, turn off the mains power and remove the cable, any fuses and fuse assemblies. All hazardous wiring must be immediately destroyed and replaced in accordance to the above standard.

# G E T T I N G S T A R T E D

This chapter describes the GBM-3000 SERIES in a nutshell, including accessories, package contents, its main features and front / rear panel introduction.



|                                    |    |
|------------------------------------|----|
| GBM Series Overview .....          | 12 |
| Series lineup .....                | 12 |
| Characteristics .....              | 12 |
| Accessories .....                  | 15 |
| Package Contents .....             | 16 |
| Appearance .....                   | 17 |
| Front Panel .....                  | 17 |
| Rear Panel .....                   | 19 |
| Set Up .....                       | 20 |
| Tilting the Stand .....            | 20 |
| Power UP .....                     | 22 |
| Connect to the test terminal ..... | 22 |

## GBM Series Overview

### Series lineup

The GBM-3000 series consists of 2 models as list below.

| Model name    | Basic accuracy                     | Test speed | Interface             |
|---------------|------------------------------------|------------|-----------------------|
| GBM-3080/3300 | Resistance: 0.5%<br>Voltage: 0.01% | 65 times/s | RS 232/USB<br>Handler |

| Model name | Measurement range   |
|------------|---|
| GBM-3080   | Resistance: 0.0001m $\Omega$ ~3.2k $\Omega$ ; Voltage: 0.00001~80.000V  |
| GBM-3300   | Resistance: 0.0001m $\Omega$ ~3.2k $\Omega$ ; Voltage: 0.00001~300.000V |

### Characteristics

Thank you for purchasing the GBM-3300/ GBM-3080 battery meter. The GBM-3000 series uses 32-bit ARM microprocessor control and 4.3-inch true color LCD display.

It can be used to test resistance ranging from 0.0001m $\Omega$  to 3.2k $\Omega$  and test DC voltage ranging from 0.00001V to 300.000V. The GBM-3000 series has several characteristics such as high accuracy, high resolution and ultra-high speed measurement with 0.5% resistance accuracy and 0.01% voltage accuracy and up to measurement speed of 65 times per second.

Comparator function and Handler (PLC) interface can be used to output HIGH/ IN/ LOW resistance signal and HIGH/ IN/ LOW voltage signal. It can meet the require of automatic sorting system to complete the fully automated assembly line test, while enhance IO signal to drive power relays and signal relays directly.

The built-in RS-232C interface and USB interface can be used for remote control and data acquisition and analysis.

The new improved design of AC resistance test principle can be used for almost all battery internal resistance test, including lithium batteries, lead-acid batteries, button batteries and other batteries.

---

|             |  |
|-------------|--|
| Performance | <ul style="list-style-type: none"><li>• 1kHz test frequency</li><li>• Basic accuracy for resistance: 0.5%</li><li>• Basic accuracy for voltage: 0.01%</li></ul>  |
| Features    | <ul style="list-style-type: none"><li>• 7 ranges for test, range from 3mΩ to 3kΩ, including auto, manual and nominal range mode. Nominal range mode: The instrument automatically selects the best range based on the nominal value.</li><li>• 4 test speeds are available for selection. Including slow, medium, fast and exfast test. When all channels opened and measurement in manual mode. 3 times per second for slow speed mode; 14 times per second for medium speed mode; 25 times per second for fast speed mode; 65 times per second for exfast mode.</li><li>• 2 trigger modes, including internal and external.</li><li>• Calibration function<br/>Short circuit clearing for full ranges is to eliminate the influence of lead resistance.</li><li>• System configuration, including data retention function, alarm setting, keyboard lock function and administrator and user accounts which allows to set a password for administrator</li><li>• Comparator function (Sorting function), including RHI/RNG/RLO output, VHI/VNG/VLO output and total NG/OK output.</li><li>• Comparison method:<br/>Absolute tolerance <math>\pm</math> TOL sorting: The absolute deviation of the measured value from the nominal value is compared with the limit of each range.</li></ul> |

Percent tolerance %TOL sorting: The percentage deviation of the measured value from the nominal value is compared with the limit of each range.

Sequential sorting: The measured value is directly compared with the upper and lower limits setting.

---

#### Interface

- RS-232 / USB remote control:

Support up to maximum 115200bps serial transmission rate, compatible SCPI agreement and ASCII transmission.

- Handler I/O interface

All isolation with opt coupler. It equipped with built-in input and output port to pull up resistance.

Input: Trigger signal.

Output: All result signal after sorting comparison, measuring synchronization signal (EOC) and high current drive output which directly drives relay.

---

## Accessories

| Standard Accessories | Part number      | Description                  |
|----------------------|------------------|------------------------------|
|                      | 82BM-01000E01    | User Manual CD               |
|                      | 82BM-01000M01    | Safety Instruction Sheet     |
|                      | Region dependent | Power Cord                   |
|                      | GBM-01           | Test Fixture(Kelvin Clip)    |
| Optional Accessories | Part number      | Description                  |
|                      | GBM-02           | Test Fixture(Single Needle)  |
|                      | GBM-03           | Test Fixture(Twin Needle)    |
|                      | GBM-S1           | Short Board                  |
|                      | GTL-232          | RS232C cable                 |
|                      | GTL-246          | USB cable                    |
|                      | GRA-422          | Rack Adapter Panel (19", 2U) |

## Package Contents

Check the contents before using the instrument.

---

### Opening the box

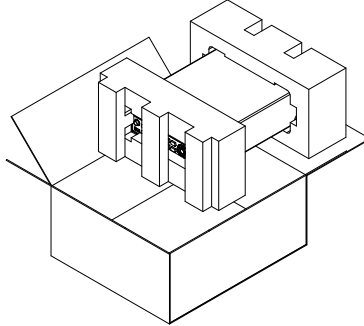

---

Contents  
(single unit)

- Main unit
- Test Fixture (Kelvin Clip)
- Power cord x1 (region dependent)
- User manual CD
- Safety instruction sheet



# Appearance

## Front Panel

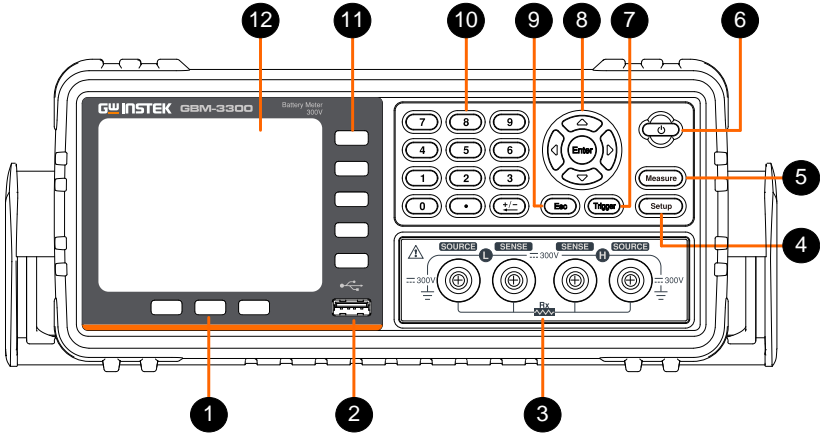

- 
- 1 Function keys

These three keys are used for entering system configuration page, activating system configuration enlarge and lock key function.
  
  - 2 USB port



The Host port is a type A USB port for logging data and connecting USB memory devices only.

USB disk type: Flash drive only

Format: FAT/FAT32/exFAT

Max memory size: 128GB.
  
  - 3 Test terminals





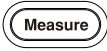

Test terminals are used to connect test fixture.
  
  - 4 Setup key



This key is used for entering measurement setup page.
  
  - 5 Measure key

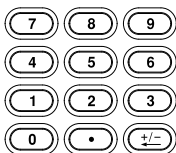
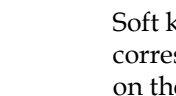

This key is used for entering measurement display page.

- 6 Power switch  This key is used to turn the device instrument on/off. On = light green, Off = light red.
- 7 Trigger key  If trigger mode is set to external, this key can be used to measure trigger. Please refer to page 30 for details.
- 8 Arrow Keys and Enter key  The arrow keys are used to navigate the cursor on the screen.  
Enter key is used to confirm the value which input from the numeric keypad.  
When a flash drive is inserted from the USB port on the front panel. A message "USB disk ready Press <Enter> to save screen" appears on the lower part of the LCD screen. At this moment, Enter key can be used to take a screenshot.
- 9 ESC key  Press this button to return the cursor to the top left corner of the currently displayed page or cancel current setting.
- 10 Numeric keys  The numeric keypad is used to input values for setting.
- 11 Option keys  Soft keys for use to select corresponding option which located on the right of the LCD screen.
- 12 LCD  4.3" TFT- LCD display.

Rear Panel

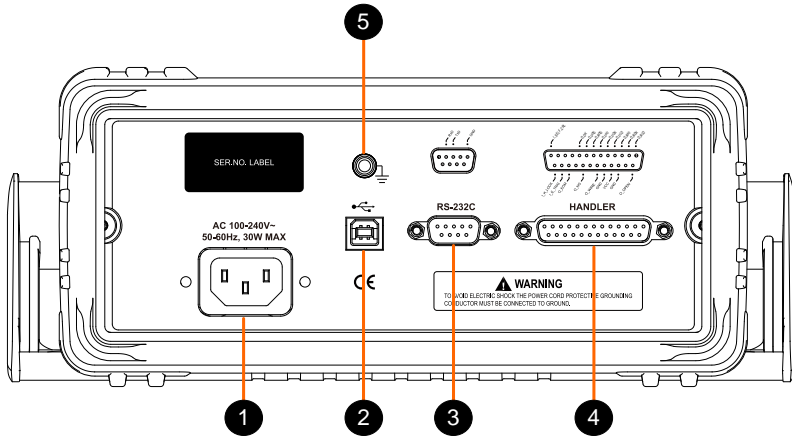

- 1 Power Cord Socket

AC 100-240V~  
50-60Hz, 30W MAX

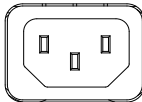

Power Socket:  
100~240V, 50/60Hz, 10W.

- 2 USB Device Port

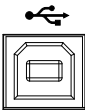

Type B USB port. This port is used for remote control.

- 3 RS232

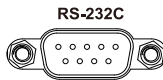

RS 232 port

- 4 Handler interface

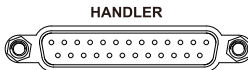

Handler I/O port

- 5 Frame terminal



This terminal is used for grounding.

## Set Up

### Tilting the Stand

---

From the base of the handle, gently pull the handle out sideways and then rotate it to one of the following positions.

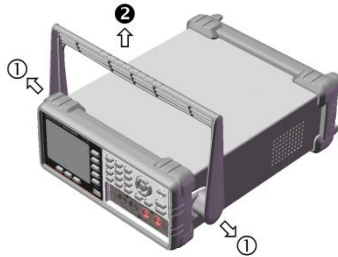

Horizontal  
position



Tilt stand  
position



Carry position



## Power UP

---

- Steps
1. Insert the AC power cord into the power socket.
  2. The power button will be lit red to indicate that the GBM-3000 series is in standby mode.



3. Press the power button to turn the GBM-3000 series on.
4. The power button will turn green and the GBM-3000 series will start to boot up.

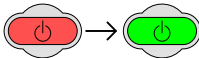

## Connect to the test terminal

---

Background Please use the "GBM-01" test cable which comes with the device to connect to the test terminal for testing. Please follow the procedure list below to connect.

---

Steps Please insert correctly the test cable to "Sense" and "Source" terminals of the device. Insert the red cable ends to terminals that marked in H (positive) and the black cable ends to terminals that marked in L(Negative) as shown in diagram below.

---

Connection  
diagram

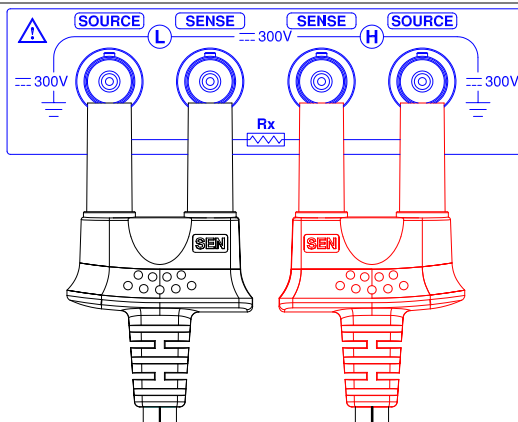

Note

Avoid wrong connection, which would lead to incorrect reading value.

In order to ensure the accuracy of the instrument, please use the GBM-3000 optional accessories test cable for test.



Warning

Do not connect the AC current source and voltage source directly to the test terminals.



Warning

Before connecting the test leads, make sure the test leads are not connected to any batteries to avoid personal injury or damage to the instrument.

# SETTING UP

In this chapter you will learn about all the measurement-related settings. All the measurement setting items can be found on the [MEAS SETUP] page.

---

|   |    |
|---|----|
| Setting up the measurement item .....                     | 25 |
| Setting measurement function and corresponding range..... | 26 |
| Setting measurement speed.....                            | 29 |
| Setting trigger mode .....                                | 30 |
| Setting average measurement frequency (AVG) .....         | 32 |
| Setting delay timer .....                                 | 33 |
| Setting self-calibration function .....                   | 34 |
| Setting the output current mode.....                      | 36 |
| Setting up monitor parameter and nominal value .....      | 37 |
| Setting edge .....  | 39 |
| Setting up comparator.....                                | 40 |
| Setting USB disk.....                                     | 44 |



## Setting up the measurement item

You can set up the following measurement items from the [MEAS SETUP] page. While on the [MEAS SETUP] page, the device is still testing although the device doesn't display the test result.

- Setting measurement function and its range → from page 26
- Setting measurement speed → from page 29
- Setting trigger mode → from page 30
- Setting measurement frequency → from page 32
- Setting delay timer → from page 33
- Setting self-calibration → from page 34
- Setting output current mode → from page 36
- Setting monitoring parameter → from page 37
- Setting edge → from page 39

## Setting measurement function and corresponding range

Steps

1. Press the **Setup** button to enter [MEAS SETUP] page.



2. Use arrow keys to move the cursor and select **FUNC** item on the [MEAS SETUP] page.

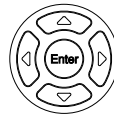

3. Use option key on the right of the LCD screen to select a parameter for this measurement item.

|           |     |  |
|-----------|-----|--|
| Parameter | R-V | Measure and display both the resistance and voltage of battery under test. |
|-----------|-----|--|

- R Measure and display the resistance of battery under test.
- V Measure and display the voltage of battery under test.

Set measurement range 4. Use arrow keys to move the cursor to corresponding measurement range.

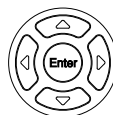

5. Use option key on the right of the LCD screen to select a desired measurement range.

|                   |            |   |
|-------------------|------------|---|
| Measurement range | AUTO RANGE | The device will automatically select the best range to test.                            |
|                   | HOLD RANGE | The device will always performe test with a user-specified range.                       |
|                   | NOM RANGE  | The device will automatically select the best range to test based on the nominal value. |
|                   | INCR+      | Increase the range number and set to hold range.  |
|                   | DECL-      | Decrease the range number and set to hold range.  |



Note

Among the measurement items, the FUNC, RANGE and SPEED measurement items can also be set from [MEAS DISPLAY] page. Please refer to page 51 for details about setting these setting items.

## Setting measurement speed

The GBM-3300/3080 offers 4 test speeds (Slow, Medium, Fast and Exfast). The slower the test, the more accurate and stable the test result.

In the R-V function and manual range mode, the sampling time for enabling the comparator is as follows:

### Test Speed

|        |                     |
|--------|---------------------|
| Slow   | 3 times/sec (350ms) |
| Medium | 14 times/sec (71ms) |
| Fast   | 25 times/sec (40ms) |
| Exfast | 65 times/sec (15ms) |

### Steps

1. Press the **Setup** button to enter [MEAS SETUP] page.

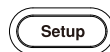

2. Use arrow keys to move cursor and select **SPEED** item on the [MEAS SETUP] page.

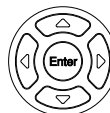

3. Use option key on the right of the LCD screen to select a test speed for this measurement item.

|                      |        |              |
|----------------------|--------|--------------|
| Available test speed | Slow   | 3 times/sec  |
|                      | Medium | 14 times/sec |
|                      | Fast   | 25 times/sec |
|                      | Exfast | 65 times/sec |

## Setting trigger mode

Steps

1. Press the **Setup** button to enter [MEAS SETUP] page.



2. Use arrow keys to move cursor and select **TRIGGER** item on the [MEAS SETUP] page.

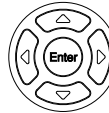

3. Use option key on the right of the LCD screen to select a trigger mode for this measurement item.

Available parameter

- INT Internal trigger mode is also known as continuous test. The trigger signal performs continuous test in accordance with the original cycle of the device.
- EXT External trigger mode, including Manual/Handler/Remote control mode.
  - Manual trigger mode: The device performs

a measurement once the Trigger key is pressed and standby for the rest of the time.

- Handler trigger mode: When a rising/falling edge pulse is received from the handler interface on the rear panel, the device performs a measurement cycle and standby for the rest of the time. Please refer to Handler interface on page 97 for details.
- Remote control mode: When a measurement command is sent from the RS-232 or USB interface, the device performs a measurement cycle and returns the measured value.

## Setting average measurement frequency (AVG)

This function is to perform multiple measurements and take an average result from multiple measurements as the final display value. The stability and reliability of the measurement results can be improved by utilizing this function. The measurement frequencies can be set from 1 to 256.

### Steps

1. Press the **Setup** button to enter [MEAS SETUP] page.



2. Use arrow keys to move cursor and select **AVG** on the [MEAS SETUP] page.

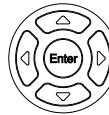

3. Use option key on the right of the LCD screen to increase or decrease average measurement frequency.

Available parameter

- INCR+ Increase the measurement frequencies with frequency 1, 2, 4, 8, 16, 32, 64, 128 and 256.
- DECL- Decrease the measurement frequencies with frequency 256, 128, 64, 32, 16, 8, 4, 2 and 1.



## Setting delay timer

The device can set the delay time before each test by setting trigger **DELAY** timer.

The maximum delay time is 10s and the minimum is 1ms.

### Steps

1. Press the **Setup** button to enter [MEAS SETUP] page.
2. Use arrow keys to move cursor and select **DELAY** on the [MEAS SETUP] page.

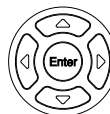
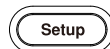

3. Use option key on the right of the LCD screen to turn on delay timer function.
4. Use key pad to input delay timer value and option key on the right of the LCD screen to select corresponding unit.

### Available parameter

- |     |   |
|-----|---|
| ON  | Enable the delay timer function. The maximum delay time is 10s and the minimum delay time is 1ms. |
| OFF | Disable the delay timer function  |

## Setting self-calibration function

The self-calibration function can remove the bias voltage and gain drift of the internal circuit of the instrument to improve the measurement accuracy.

The device always performs self-calibration at slow speed, regardless of whether the self-calibration is enabled or disabled.

Above medium speed, if the self-calibration is enabled, the instrument will automatically perform a calibration every 30 minutes.

If you use an external trigger, self-calibration will not be performed. Use only the Handler's external calibration feature to avoid influence of measurement process.

### Steps

1. Press the **Setup** button to enter [MEAS SETUP] page.



2. Use arrow keys to move cursor and select **SELF-CAL** on the [MEAS SETUP] page.



3. Use option key on the right of the LCD screen to select an available parameter.

---

|                     |     |  |
|---------------------|-----|--|
| Available parameter | ON  | Enable the self-calibration function. The device will perform a self-calibration every 30 minutes.<br>After the self-calibration, a message "Self-Calibration was successful" will display on the message column below the LCD to indicate that self-calibration has been completed. |
|                     | OFF | Disable the self-calibration function.   |

---

**Note**

When self-calibration is performed, the measurement will pause briefly to respond to the self-calibration.

A self-calibration takes 40ms. It is necessary to disable the self-calibration function when performing high-speed measurement and use external I/O control cord for self-calibration.

To ensure accuracy, the device performs a self-calibration each time when it is turned on.

In addition to regular self-calibration, you also can perform a self-calibration by using

1. The SELF.CAL signal of HANDLER.
2. The communication command [SYST: CALibration].

## Setting the output current mode

When several identical devices measure in parallel, the measured signals will interfere with each other, causing the measured value to change suddenly. To prevent measurement error, change the current output mode to **PAUSE** which will turn off the current source after the test is completed to minimize the interference of multiple devices.

### Steps

1. Press the **Setup** button to enter [MEAS SETUP] page.



2. Use arrow keys to move cursor and select **CURRENT** on the [MEAS SETUP] page.

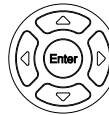

3. Use option key on the right of the LCD screen to select an available parameter.

### Available parameter

- |            |   |
|------------|---|
| CONTINUOUS | Output current continuously.  |
| PAUSE      | Output current only during measurement and turn off signal source after measurement is completed. |

## Setting up monitor parameter and nominal value

The instrument can monitor extra one parameter while measuring the primary and secondary parameters.

### Steps

1. Press the **Setup** button to enter [MEAS SETUP] page.



2. Use arrow keys to move cursor and select **MONITOR** on the [MEAS SETUP] page.



3. Use option key on the right of the LCD screen to select a monitor parameter or turn off monitor function by pushing OFF button.

- If a monitor mode is selected, use arrow keys to move cursor and select **NOMINAL** on the [MEAS SETUP] page.

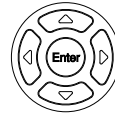

- Use key pad to input nominal value and unit.

|                     |     |  |
|---------------------|-----|--|
| Available parameter | OFF | Disable the monitoring parameter function.   |
|                     | RΔ  | Resistance absolute deviation value<br>( $R\Delta = R_x - R_{nom}$ )               |
|                     | R%  | Resistance relative deviation value<br>( $R\% = (R_x - R_{nom}) / R_{nom} * 100$ ) |
|                     | VΔ  | Voltage absolute deviation value<br>( $V\Delta = V_x - V_{nom}$ )                  |
|                     | V%  | Voltage relative deviation value<br>( $V\% = (V_x - V_{nom}) / V_{nom} * 100$ )    |



**Note**

The additional monitoring parameter don't increase processing time of the device. The default setting is **OFF**. Since the monitoring parameters are related to the nominal value, once the monitoring parameter is enabled, the **NOMINAL** field will be displayed on the screen which is same as that in [COMP SETUP] page. Please refer to page 40

## Setting edge

This parameter setting is used to set the way of trigger signal of TRIG pin when using Handler interface as data transmission. This setting is valid only when TRIGGER mode is set to EXT.

### Steps

1. Press the **Setup** button to enter [MEAS SETUP] page.



2. Use arrow keys to move cursor and select **MONITOR** on the [MEAS SETUP] page.

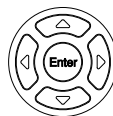

3. Use Option key on the right of the LCD screen to select an available parameter

### Available parameter

- |              |  |
|--------------|--|
| Rising edge  | When input signal of TRIG pin is a rising edge, trigger measurement is performed.  |
| Falling edge | When input signal of TRIG pin is a falling edge, trigger measurement is performed. |

## Setting up comparator

In this section, user will learn how to set up comparator. The device can perform comparator function for resistance and voltage simultaneously or separately.

**Steps**

1. Press the **Setup** button to enter [MEAS SETUP] page.

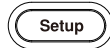

2. Press the **COMP SETUP** Option key on the right of the LCD screen.





Set up buzzer

- Use arrow keys to select **BEEP** on the [COMP SETUP] page.



Available options

- OFF      Disable the buzzer.
- PASS    The buzzer tweets when the sorting result is passed.
- FAIL    The buzzer tweets when the sorting result is failed.

Set up comparator

- Use arrow keys to move cursor and select **R-COMP** or **V-COMP** on the [COMP SETUP] page.



Available options

- OFF      Disable the R-COM/VCOM funtion.
- ON      Enable the R-COM/VCOM funtion.

Set up comparator mode

- Use arrow keys to move cursor and select **R-MODE** or **V-MODE** on the [COMP SETUP] page.



Available options SEQ

SEQ comparison mode is used to compare the upper and lower limits of the setting range for voltage and resistance with the measurement reading, so nominal value isn't required for calculation.

PER (Measurement reading – nominal value)/nominal value x 100%

ABS Measurement reading – nominal value

Input normal value

- Use arrow keys to select **R-NOM** or **V-NOM** on the [COMP SETUP] page when comparator mode is set to PER or ABS mode.



- Use key pad to input normal value and option key on the right of the LCD screen to select corresponding resistance and voltage unit.

Input upper and lower range

- Use arrow keys to select **R-LOWER** or **V-LOWER** and **R-UPPER** or **V-UPPER** on the [COMP SETUP] page.



- Use key pad to input upper and lower limits values and option key on the right of the LCD screen to select corresponding resistance and voltage unit.

## Setting USB disk

In this section, user will learn how to set up USB flash drive for saving measurement data. Since the amount of measurement data saved in USB flash drive is larger than that saved in data buffer of the device, this means of saving measurement data can be used to save measurement data of battery test in the production line of factory.

### Steps

1. Insert a USB flash drive for using as data recoding.
2. Press the **Setup** button to enter [MEAS SETUP] page.





3. Press the **USBDISK SETUP** option key on the right of the LCD screen.

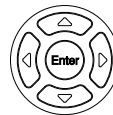

Create new file

4. Use arrow keys to select **FILE** on the [USBDISK SETUP] page.



5. Press **CREATE FILE** option key on the right of the LCD.
6. A window “INPUT FILE NAME” pops up. Input file name you desired and then press Enter key to create a new file. The new created file will be list under the title “FILE NAME”. You can create as many files as you want.



- You can use arrow keys to select a file and then press **OPEN** option key on the right of the LCD to open it. The opened files will have a red dot with a check mark in front of file name.



- Select the opened file and press **CLOSE** option key on the right of the LCD to close the file. The red dot in front of file name will disappear and a message "file closed" displays on the lower left part of the screen.
- Press **DELETE** option key on the right of the LCD to delete selected file.

Setup Timer

10. Use arrow keys to select **TIMER** on the [USBDISK SETUP] page.

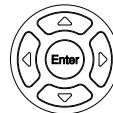

11. Enter a number from key pad, then press “s” option key on the right of the LCD screen to set interval time for recording measurement data.

Setup AUTO OPEN

12. Use arrow keys to select **AUTO OPEN** on the [USBDISK SETUP] page.



Available options ON

Enable auto open function. The measurement data will be saved to the original opened file when USB flash drive been inserted to the device again.

- OFF Disable auto open function.

# M EASUREMENT

In this chapter you will learn about all information on [MEAS DISPLAY] page.

---

|   |    |
|---|----|
| How to enter [MEAS DISPLAY] page .....          | 49 |
| Setting up measurement function .....           | 51 |
| Setting up corresponding measurement range..... | 52 |
| Range for resistance .....                      | 53 |
| Range for voltage .....                         | 53 |
| Abnormal value description .....                | 53 |
| Judgment result area .....                      | 54 |
| Setting up measurement speed.....               | 55 |



## How to enter [MEAS DISPLAY] page

### Steps

1. Press the **Measure** button to enter [MEAS DISPLAY] page on the LCD screen.

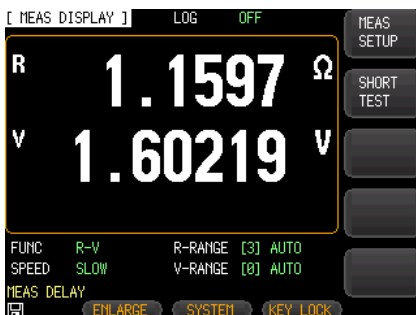

2. Press **ENLARGE** key below the LCD screen to enlarge resistance and voltage values on the screen.

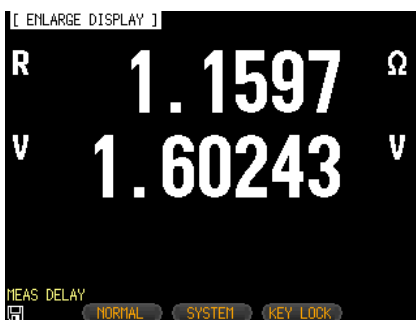

Note

There is another way to enter the [MEAS DISPLAY] page. The steps are as follow:

1. Press the **Setup** button to enter [MEAS SETUP] page.



2. Press the **MEAS DISPLAY** option key on the right of the LCD screen. The **MEAS DISPLAY** page will display on the screen.

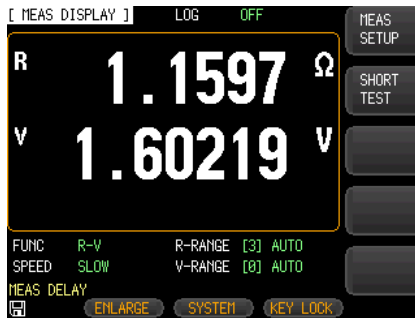

## Setting up measurement function

Steps

1. Press the **Measure** button to enter [MEAS DISPLAY] page on the LCD screen.



2. Use arrow keys to move the cursor and select **FUNC** item on the [MEAS DISPLAY] page.



3. Use option key on the right of the LCD screen to select a parameter for this measurement item.

Parameter

- R-V Measure and display both the resistance and voltage of battery under test.
- R Measure and display the resistance of battery under test.
- V Measure and display the voltage of battery under test.

## Setting up corresponding measurement range

- Steps
1. After setting measurement function, set its corresponding range.
  2. Use arrow keys to move the cursor and select **R-RANGE** and **V-RANGE** item on the [MEAS DISPLAY] page.

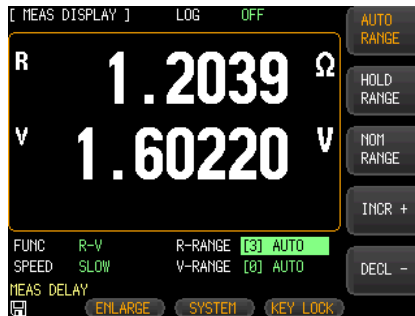

3. Use option key on the right of the LCD screen to select a parameter for this measurement item.

|                   |                   |   |
|-------------------|-------------------|---|
| Measurement range | <b>AUTO RANGE</b> | The device will automatically select the best range to test.                            |
|                   | <b>HOLD RANGE</b> | The device will always perform test with a user-specified range.                        |
|                   | <b>NOM RANGE</b>  | The device will automatically select the best range to test based on the nominal value. |
|                   | <b>INCR+</b>      | Increase the range number and set to hold range.  |

DECL-            Decrease the range number and set to hold range.

## Range for resistance

The GBM-3000 series has seven ranges for resistance with varying ranges for each range as follows:



| Range no. | Range name | Range               |
|-----------|------------|---------------------|
| 0         | 3mΩ        | 0.0000mΩ ~ 3.1000mΩ |
| 1         | 30mΩ       | 0.000mΩ ~ 31.000mΩ  |
| 2         | 300mΩ      | 0.00mΩ ~ 310.00mΩ   |
| 3         | 3Ω         | 0.0000Ω ~ 3.1000Ω   |
| 4         | 30Ω        | 0.000Ω ~ 31.000Ω    |
| 5         | 300Ω       | 0.00Ω ~ 310.00Ω     |
| 6         | 3kΩ        | 0.0Ω ~ 3200.0Ω      |

## Range for voltage

The GBM-3000 series has three ranges for voltage with varying ranges for each range as follows:

| Range no. | Range name | Range                              |
|-----------|------------|------------------------------------|
| 0         | 8V         | 0.00000V~8.08000V                  |
| 1         | 80V        | 0.0000V~80.8000V                   |
| 2         | 300V       | 0.000V~303.000V(For GBM-3300 only) |

## Abnormal value description

| Display on the screen   | Description                                       |
|---|---|
|  | Unable to determine                               |
|  | Measured value is higher than the measuring range |
|  | Measured value is lower than the measuring range  |

## Judgment result area



There are 4 kind of judgement results could display on the LCD screen.

### Display on the screen Description



R:----- V:-----

H-SENSE or L-SENSE isn't connected to battery  
H-SOURCE or L-SOURCE isn't connected to battery.



R:----- V:x.xxxxxx

H-SOURCE or L-SOURCE isn't connected to battery.



All test results are OK after comparison.



Some test results are HI or LO after comparison

## Setting up measurement speed

Steps

1. Press the **Measure** button to enter [MEAS DISPLAY] page on the LCD screen.



2. Use arrow keys to move the cursor and select **SPEED** item on the [MEAS DISPLAY] page.

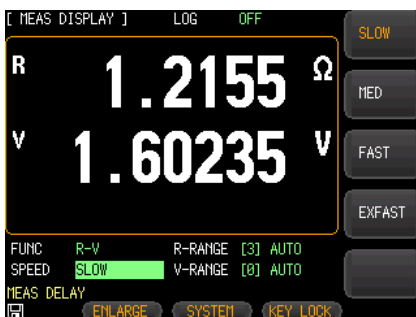

3. Use option key on the right of the LCD screen to select a parameter for this measurement item.

Available test speed

SLOW 3 times/sec

MED 14 times/sec

FAST 25 times/sec

EXFAST 65 times/sec

# DATA LOGGING AND STATISTICS

In this section, user will learn how to enable the data logging function and perform statistics function.

---

|  |    |
|--|----|
| Data logging function .....                      | 57 |
| Set up data logging function .....               | 57 |
| Set up the data buffer .....                     | 58 |
| Start the continuous data logging function ..... | 60 |
| Activate a single data logging.....              | 61 |
| Stop the data logging.....                       | 63 |
| Saving data to USB flash drive .....             | 64 |
| Statistics function.....                         | 66 |
| Set up statistics function .....                 | 66 |
| Set up the data buffer .....                     | 67 |
| Start the statistics function .....              | 68 |
| Stop the statistics of data .....                | 69 |
| Saving data to USB flash drive .....             | 70 |
| Process Capability Index.....                    | 70 |
| Setting up statistics parameters.....            | 72 |



## Data logging function

The device allows users to record measured data and then perform statistics from them. The data logging function can only be operated and displayed on the [MEAS DISPLAY] page.

The data **DATA LOG** field will be displayed on the top of [MEAS DISPLAY] page after the data logging function is enabled.

The measured data can be instantly stored in the device's buffer through the data logging function. These data can be sent to the computer through the communication interface or saved in CSV format directly to the USB flash drive.

### Set up data logging function

#### Steps

1. Press the **Measure** or **Setup** key on the front panel of the GBM-3300.



or



2. Press **SYSTEM** key below the LCD screen to enter [SYSTEM CONFIG] setting page.

3. Use arrow keys to select **DATA LOGGER** field as shown in the picture below.

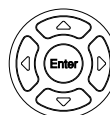

4. Press the **LOG** option key on the right of the LCD screen.
5. The **LOG** field will be displayed on the upper side of [MEAS DISPLAY] page after the data logging function is enabled as shown in the picture below.

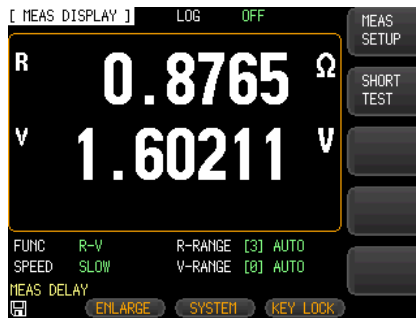

### Set up the data buffer

The data buffer setting sets the maximum number of record counts that the internal buffers can store. Settable range is 1 to 10000.

Steps

1. Press the **Measure** or **Setup** key on the front panel of the GBM-3300.

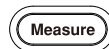

or



Steps

2. Press **SYSTEM** key below the LCD screen to enter [SYSTEM CONFIG] setting page.

3. Use arrow keys to select **BUFFER** on this SYSTEM CONFIG setting page. The selected item will be highlighted.



4. Enter a number from key pad, then press Enter key or press MAX option key on the right of the LCD to set up the number of data for logging.

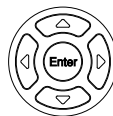

Available options    MAX    Set the number for data logging to maximum 10,000 sets.

## Start the continuous data logging function

### Steps

1. Use arrow keys to select **LOG** field on the upper side of the LCD screen.

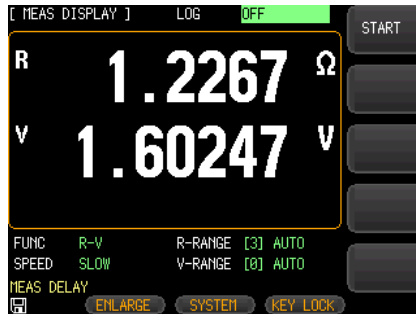
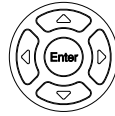

2. Press the **START** option key on the right of the LCD screen to start continuous data logging function. The data logging will keep running until the number of setting buffer is up.
3. When data logging runs until the number of setting buffer, you will see an exclamation mark and **FULL** display on the upper side of LCD screen as shown in the picture below.

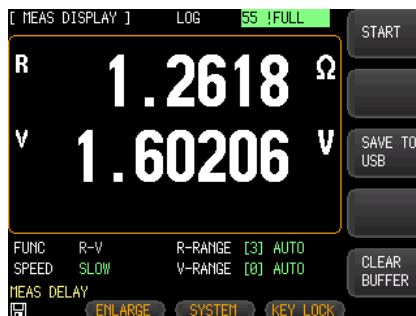



Note

- SCPI command “:LOG:START ON” can also be used to start continuous data logging.
- Before start continuous data logging, check if trigger mode set to INT.
- Once data logging is enabled, the measurement page will be locked and unable to switch to another page. User must stop data logging faction first, so as to switch to other page.

## Activate a single data logging

---

Steps

1. Set trigger mode to EXT mode.



- Use arrow keys to select **LOG** field on the upper side of the LCD screen. Press the **START** option key on the right of the LCD screen

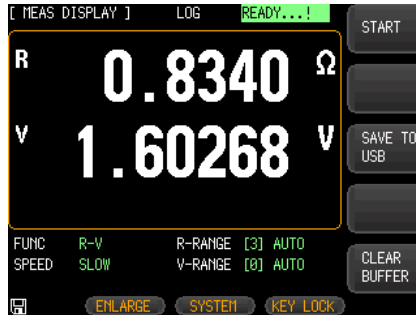
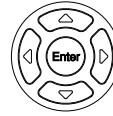

- Press **Trigger** button on the front panel to start a single data logging.
- You can see the number on LOG filed increase by one when pressing the trigger key once.

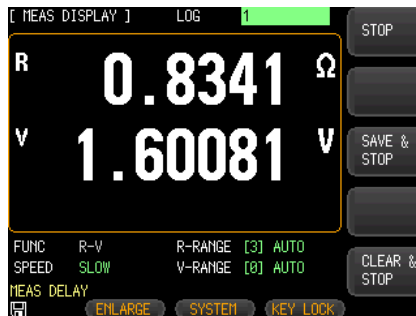

 Note

- User must disable the data logging function first before switching to other pages in the external trigger mode.
- SCPI command “:TRIGGER” or handler external trigger port can also be used to activate a single data logging.

## Stop the data logging

---

- Steps
1. You can press the **STOP** key option key on the right of the LCD screen at any time to stop data logging function when data logging is processing. An exclamation mark displays on the upper side of LCD screen to indicate that data logging function stops as shown in the picture below.

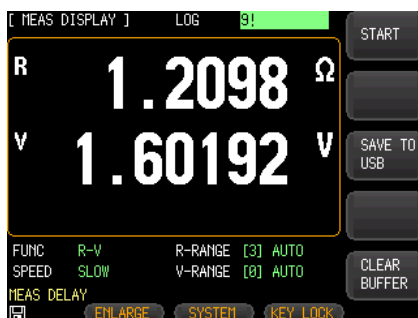

2. Press the **START** option key on the right of the LCD screen again to restart the data logging function.
3. Press **CLEAR BUFFER** option key on the right of the LCD screen to clear data in the buffer.



Note

- SCPI command “:LOG:START OFF” also can be used to stop data logging.
- The data logging will start automatically if switching to [MEAS DISPLAY] page from other page.

## Saving data to USB flash drive

User can save recorded data to USB flash drive at any time after data logging is activated.

---

- Step
1. When data logging is executing, press **SAVE TO USB** option key on the right of the LCD screen at any time to save recorded data to USB flash drive. Saved file format is in CSV.

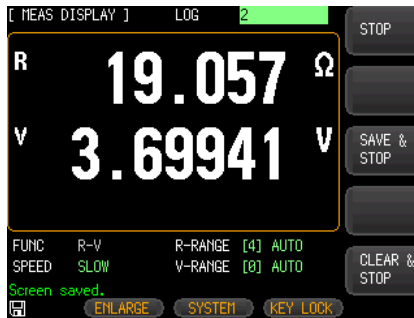

2. Open the saved file in USB flash drive with notepad or EXCEL program to edit.

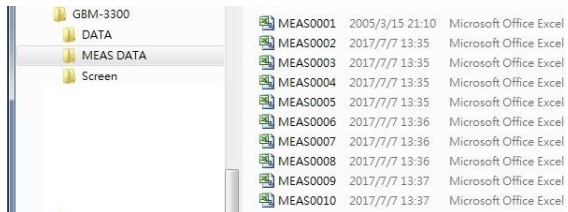



Open file with notepad

```

MEAS DATA
"File name","MEAS0034.CSV"
"Model","GBM-3300","REV B1.21"
"Log Time","2018-06-06 16:36:01"
"FUNC","R-V"
"R-COMP MODE","PER"
"R-NOMINAL","4.3000mOHM"
"R-LOWER","-5.000 %","R-UPPER","5.000 %"
"V-COMP MODE","PER"
"V-NOMINAL","3.3000 V"
"V-LOWER","-10.0000 %","V-UPPER","10.0000 %"

RESISTANCE:
,HI, 4.515 mOHM,LO, 4.085 mOHM
,Mean, 4.223 mOHM
,MAX, 4.304 mOHM
,MIN, 4.091 mOHM
,Population, 0.0001
,Sample, 0.0001
,Cp, 0.9052
,CpK, 0.5823

VOLTAGE:
,HI, 3.63000 V,LO, 2.97000 V
,Mean, 3.29298 V
    
```

Open file with Excel program

| MEAS DATA   |                  |           |            |
|-------------|------------------|-----------|------------|
| File name   | MEAS0034.CSV     |           |            |
| Model       | GBM-3300         | REV B1.21 |            |
| Log Time    | 2018/06/06 16:36 |           |            |
| FUNC        | R-V              |           |            |
| R-COMP MODE | PER              |           |            |
| R-NOMINAL   | 4.3000mOHM       |           |            |
| R-LOWER     | -5.000%          | R-UPPER   | 5.000%     |
| V-COMP MODE | PER              |           |            |
| V-NOMINAL   | 3.3000 V         |           |            |
| V-LOWER     | -10.000%         | V-UPPER   | 10.000%    |
| RESISTANCE: |                  |           |            |
| HI          | 4.515 mOHM       | LO        | 4.085 mOHM |
| Mean        | 4.223 mOHM       |           |            |
| MAX         | 4.304 mOHM       |           |            |
| MIN         | 4.091 mOHM       |           |            |
| Population  | 0.0001           |           |            |
| Sample      | 0.0001           |           |            |
| Cp          | 0.9052           |           |            |
| CpK         | 0.5823           |           |            |
| VOLTAGE:    |                  |           |            |
| HI          | 3.63000 V        | LO        | 2.97000 V  |
| Mean        | 3.29298 V        |           |            |
| MAX         | 3.29299 V        |           |            |
| MIN         | 3.29296 V        |           |            |
| Population  | 0                |           |            |
| Sample      | 0                |           |            |
| Cp          | 99.99            |           |            |
| CpK         | 99.99            |           |            |
| No          | R(OHM)           | V(V)      | STATUS     |
| 1           | 4.30E-03         | 3.29E+00  | PASS       |
| 2           | 4.30E-03         | 3.29E+00  | PASS       |
| 3           | 4.24E-03         | 3.29E+00  | PASS       |
| 4           | 4.09E-03         | 3.29E+00  | PASS       |
| 5           | 4.09E-03         | 3.29E+00  | PASS       |
| 6           | 4.19E-03         | 3.29E+00  | PASS       |
| 7           | 4.30E-03         | 3.29E+00  | PASS       |
| 8           | 4.25E-03         | 3.29E+00  | PASS       |
| 9           | 4.21E-03         | 3.29E+00  | PASS       |
| 10          | 4.26E-03         | 3.29E+00  | PASS       |



Note

Through the SCPI command, the data stored in the buffer can be sent to the computer in whole or in a single file. For detailed commands, please refer to the “Logger” commands on page 160.

## Statistics function

The device can perform real-time statistics for the recorded data in order to perform quality control more easily.

### Set up statistics function

Steps

1. Press the **Measure** or **Setup** key on the front panel of the GBM-3300.

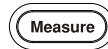

or



2. Press **SYSTEM** key below the LCD screen to enter [SYSTEM CONFIG] setting page.

3. Use arrow keys to select **DATA LOGGER** field as shown in the picture below.

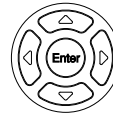

4. Press the **STAT** option key on the right of the LCD screen.



- The **STAT** field will be displayed on the upper side of [MEAS DISPLAY] page after the statistics function is enabled as shown in the picture below.

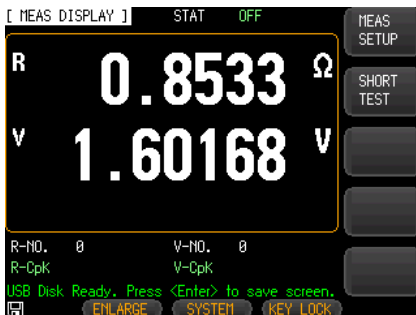

## Set up the data buffer

The data buffer setting sets the maximum number of record counts that the internal buffers can store. Settable range is 1 to 10000.

The setting steps are the same as setting data buffer for data long on page 58.

Start the statistics function

Steps

1. Use arrow keys to select **LOG** field on the upper side of the LCD screen.

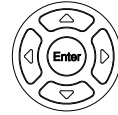

2. Press the **START** option key on the right of the LCD screen to start statistics function. The statistics of data will keep running until the number of setting buffer is up.
3. When statistics of data runs until the number of setting buffer, you will see an exclamation mark and FULL display on the upper side of LCD screen as shown in the picture below.





Note

- After the data statistics function is enabled, the instrument needs to perform complex calculations with multiple parameters, so the measurement speed will be slightly reduced.

## Stop the statistics of data

---

### Steps

1. You can press the **STOP** key option key on the right of the LCD screen at any time to stop data logging function when statistics of data is processing. An exclamation mark displays on the upper side of LCD screen to indicate that statistics function stops as shown in the picture below.



2. Press the **START** option key on the right of the LCD screen again to restart the statistics logging function.
3. Press **CLEAR BUFFER** option key on the right of the LCD screen to clear data in the buffer.

## Saving data to USB flash drive

User can save recorded data to USB flash drive at any time after statistics function is activated. The steps for saving data to USB flash drive are the same as that described in data logging section. Please refer to page 64 for details.

## Process Capability Index

Process capability refers to the ability of meeting the processing quality in process. It is to measure the minimum fluctuation in the internal consistency, steady state in the process. When the process is in steady state, the product has 99.73% of the quality characteristic values scattered in the interval  $[\mu - 3\sigma, \mu + 3\sigma]$  (where  $\mu$  is the overall mean of the product characteristic values and  $\sigma$  is the overall standard deviation of the product characteristic values). Almost all product characteristic values fall within the  $6\sigma$  range, so the process capability is usually expressed as  $6\sigma$ . The smaller the value, the better it is.

$C_p, C_{pK} > 1.33$  means that process capacity is full

$1.00 < C_p, C_{pK} \leq 1.33$  means that process capacity is appropriate

$C_p, C_{pK} \leq 1.00$  means that process capacity is not enough.

Process capability index and some related formulas:

- Mean

$$\bar{x} = \frac{\sum_{n=1}^n x}{n}$$

- Standard deviation population ( $\sigma_n$ )

$$\sigma_n = \sqrt{\frac{\sum(x - \bar{x})^2}{n}} = \sqrt{\frac{\sum x^2 - n\bar{x}^2}{n}}$$

- Standard deviation sample ( $s = \sigma_{n-1}$ )

$$s = \sigma_{n-1} = \sqrt{\frac{\sum(x - \bar{x})^2}{n-1}} = \sqrt{\frac{\sum x^2 - n\bar{x}^2}{n-1}}$$

- Process Capability Index (Deviation)  $C_p$

$$Cp = \frac{|Hi - Lo|}{6\sigma_{n-1}}$$

- Process Capability Index (Offset) CpK

$$CpK = \frac{|Hi - Lo| - |Hi + Lo - 2\bar{x}|}{6\sigma_{n-1}}$$



Note

- N stands for valid data which means that overflow and open values are excluding. As long as the digital data can be displayed on the screen, it is regarded as valid value.
- The Hi and Lo variables in the Cp and CpK formulas are the actual upper and lower limits of the comparator. In the PER and ABS comparison modes, the actual value is converted from the nominal value. This value will be taken into operation regardless of whether the comparator is enabled or not.
- When sample standard deviation  $\sigma_{n-1} = 0$ , Cp = 99.99, CpK = 99.99
- When CpK < 0, CpK = 0.

The following SCPI query commands are used to obtain related information.

Number of statistics

CALCulate:STATistic:RESistance:NUMBER?  
CALCulate:STATistic:VOLTage:NUMBER?

For detailed, please refer to page 153 and 156.

The average of statistics

CALCulate:STATistic:RESistance:MEAN?  
CALCulate:STATistic:VOLTage:MEAN?

For detailed, please refer to page 154 and 156.

The maximum value of statistics

CALCulate:STATistic:RESistance:MAXimum?  
CALCulate:STATistic:VOLTage:MAXimum?

For detailed, please refer to page 154 and 157.

|                                 |  |
|---------------------------------|--|
| The minimum value of statistics | CALCulate:STATistic:RESistance:MiMimum?<br>CALCulate:STATistic:VOLTage:MiMimum?<br>For detailed, please refer to page 154 and 157.     |
| Count value                     | CALCulate:STATistic:RESistance:LiMit?<br>CALCulate:STATistic:VOLTage:LiMit?<br>For detailed, please refer to page 155 and 157.         |
| Standard deviation value        | CALCulate:STATistic:RESistance:DEVIation?<br>CALCulate:STATistic:VOLTage:DEVIation?<br>For detailed, please refer to page 155 and 158. |
| Process capability index        | CALCulate:STATistic:RESistance:CP?<br>CALCulate:STATistic:VOLTage:CP?<br>For detailed, please refer to page 156 and 158.               |

## Setting up statistics parameters

- Steps
1. Press **Measure** button and [MEAS DISPLAY] page is appeared.
  2. Use arrow keys to select **R-CpK** and **V-CpK** fields.

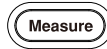

3. Use option key on the right of the LCD screen to select desired statistic parameters



|                      |                                   |                                      |
|----------------------|-----------------------------------|--------------------------------------|
| Available parameters | MEAN ( $\bar{x}$ )                | The average of statistics            |
|                      | MAX                               | The maximum value of statistics      |
|                      | MIN                               | The minimum value of statistics      |
|                      | Population $\sigma$               | Standard deviation of maternal       |
|                      | Sample(s)                         | Standard deviation of samples        |
|                      | Cp                                | Process Capability Index (Deviation) |
| Cpk                  | Process Capability Index (Offset) |                                      |



Note

- The items **R-NO.** and **V-NO.** are effective statistics amount.

R-NO. 0      V-NO. 20

- The items **R-CpK** and **V- CpK** are statistics parameters.

R-CpK      V-CpK

# S SYSTEM

## CONFIGURATION

In this section, user will learn how to set the parameters on SYSTEM CONFIG page. All settings on the SYSTEM CONFIG page are automatically saved in the system and loaded automatically at the next boot.

---

|   |    |
|---|----|
| System configuration page .....             | 75 |
| Configuring date and time .....             | 76 |
| Configuring account number .....            | 77 |
| Setting up the keypad tone .....            | 78 |
| Configuring a mode for remote control ..... | 80 |
| Setting up filter .....                     | 81 |
| Display error code .....                    | 82 |
| Restore to factory default setting .....    | 83 |
| System info page .....                      | 86 |

## System configuration page

On the system configuration page, you can set up the following items about system configuration.

- Configuring date and time → page 76
- Configuring account number → page 77
- Setting up the keypad tone → p78
- Configuring a mode for remote control → page 80
- Setting up filter → page 81
- Displaying error code → page 82

## Configuring date and time

**Steps**

1. Press the **Measure** or **Setup** key on the front panel of the GBM-3300.



or

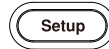

2. Press **SYSTEM** key below the LCD screen to enter [SYSTEM CONFIG] setting page.

3. Use up and down arrow keys to select **DATE/TIME** on this setting page. The selected item will be highlighted.

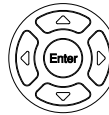

4. Press option key on the right of the LCD screen to change setting.

**Available parameter**

- |      |   |
|------|---|
| Date | YEAR INCR+, YEAR DECR- MONTH +, DAY INCR+, DAY DECR-                          |
| Time | HOUR INCR+, HOUR DECR- MINUTE INCR+, MINUTE DECR-, SECOND INCR+, SECOND DECR- |



Note

All settings on the system configuration page will be automatically saved in the system and automatically loaded at the next boot.

## Configuring account number

Steps

1. Press the **Measure** or **Setup** key on the front panel of the GBM-3300.



or



2. Press **SYSTEM** key below the LCD screen to enter [SYSTEM CONFIG] setting page.

3. Use up and down arrow keys to select **ACCOUNT** on this setting page. The selected item will be highlighted.

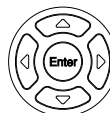

4. Press option key on the right of the LCD screen to change setting.

Available parameter

|          |                                  |
|----------|----------------------------------|
| ACCOUNT  | ADMIN, USER                      |
| PASSWORD | CHANGE PASSWORD, DELETE PASSWORD |



Note

If you select ADMIN option, all functions are available for administrator except for the [SYSTEM SERVICE] page. The parameters set by the ADMIN are stored in the system memory after a delay of 5 seconds, so as to be loaded at next boot.

If user selects USER option, all functions are available for user except for the [SYSTEM SERVICE] and [File] pages. The parameter modified by USER will not be saved and restored to the original setting set by ADMIN at next boot.



Note

When you use up and down arrow keys to select **PASSWORD** on this setting page. The selected item will be highlighted.

If you select **CHANGE PWD.**, you can enter a password combined with numbers and symbols of 9 digits at maximum.

If you select **DELETE PWD.**, ADMIN will not be protected by password.

## Setting up the keypad tone

Steps

1. Press the **Measure** or **Setup** key on the front panel of the GBM-3300.



or



2. Press **SYSTEM** key below the LCD screen to enter [SYSTEM CONFIG] setting page.

1. Use up and down arrow keys to select **KEY BEEP** on this setting page. The selected item will be highlighted.



2. Press option key on the right of the LCD screen to change setting.

Available  
parameter

- |     |                          |
|-----|--------------------------|
| ON  | Turn on the keypad tone  |
| OFF | Turn off the keypad tone |

## Configuring a mode for remote control

Steps

1. Press the **Measure** or **Setup** key on the front panel of the GBM-3300.

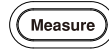

or



2. Press **SYSTEM** key below the LCD screen to enter [SYSTEM CONFIG] setting page.

1. Use up and down arrow keys to select **REMOTE** on this setting page. The selected item will be highlighted.



2. Press option key on the right of the LCD screen to change setting.

Available parameter

- |       |   |
|-------|---|
| RS232 | Select RS-232 port as remote control mode |
| USB   | Select USB port as remote control mode    |



Note

Only one mode is supported. Before selecting either a remote control mode, please connect its corresponding cable to appropriate port on the rear panel of the device.



For other setting items about remote control mode, please refer to chapter “Remote control” on page 104.

After the device detects the signal change on RS-232 or USB interface, the device will immediately communicate with the host at the setting serial transmission rate, and the keyboard will be locked as well.

In order to be able to communicate correctly, please confirm whether the setting serial transmission rate and stop bit are set correctly. Otherwise the device won't be able to communicate with host computer correctly.

## Setting up filter

Steps

1. Press the **Measure** or **Setup** key on the front panel of the GBM-3300.

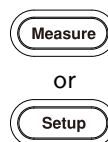

Steps

2. Press **SYSTEM** key below the LCD screen to enter [SYSTEM CONFIG] setting page.

- Use up and down arrow keys to select **FILTER** on this setting page. The selected item will be highlighted.

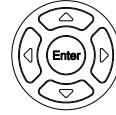

- Press option key on the right of the LCD screen to change setting.

|                     |      |  |
|---------------------|------|--|
| Available parameter | Auto | Automatically select 50 or 60Hz according to AC power frequency. |
|                     | 50Hz | Suitable for AC power frequency 50Hz                             |
|                     | 60Hz | Suitable for AC power frequency 60Hz                             |

### Display error code

If the error code setting is set to on, the meter will return error codes if the wrong command or an invalid command is received to help you to debug your control program.

- Steps
- Press the **Measure** or **Setup** key on the front panel of the GBM-3300.

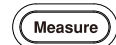

or

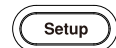

2. Press **SYSTEM** key below the LCD screen to enter [SYSTEM CONFIG] setting page.
3. Use up and down arrow keys to select **ERROR CODE** on this setting page. The selected item will be highlighted.



4. Press **ON** and then YES option key on the right of the LCD screen to change setting.

|                     |     |  |
|---------------------|-----|--|
| Available parameter | ON  | Return when error occurs.                    |
|                     | OFF | Error code isn't returned when error occurs. |

### Restore to factory default setting

After executing the factory default setting, all settings of the device will be restored to factory default settings, including all parameters on the following pages

#### Steps

1. Press the **Measure** or **Setup** key on the front panel of the GBM-3300.

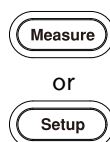

2. Press **SYSTEM** key below the LCD screen to enter [SYSTEM CONFIG] setting page.
3. Use up and down arrow keys to select **DEFAULTL SET** on this setting page. The selected item will be highlighted.

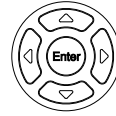

4. Press **ON** and then **YES** option key on the right of the LCD screen to change setting.

---

|                     |     |   |
|---------------------|-----|---|
| Available parameter | ON  | Return all parameters to factory default setting              |
|                     | OFF | Keep current settings and didn't do any change on parameters. |

After restoring to factory default setting, you can see SYSTEM CONFIG and MEAS SETUP page return to its original status.

For details about the GBM-3300 factory default settings, please refer to page 178.

SYSTEM CONFIG



MEAS SETUP



## System info page

To check system info, please follow the steps list below.

Steps

1. Press the **Measure** or **Setup** key on the front panel of the GBM-3300.



or



2. Press **SYSTEM** key below the LCD screen to enter [SYSTEM CONFIG] setting page.



3. Press **SYSTEM INFO** option key on the right of the LCD screen to enter [SYSTEM INFORMATION] page.



Note

There is not any option that user can configure on System Information page.

# OTHER FUNCTIONS

---

|  |     |
|--|-----|
| Offsetting before short-circuit test ..... | 89  |
| Offsetting of test leads .....             | 90  |
| Short-circuit test .....                   | 94  |
| Handler Overview .....                     | 97  |
| Terminal and signals.....                  | 97  |
| Output terminal .....                      | 97  |
| Input terminal .....                       | 98  |
| Power source terminal.....                 | 98  |
| Connection .....                           | 98  |
| User internal power .....                  | 99  |
| Electrical parameters .....                | 99  |
| Schematic diagrams .....                   | 100 |
| Connection method for input circuit .....  | 100 |
| Connection method for output circuit ..... | 101 |



## Offsetting before short-circuit test

Before performing short-circuit test, be sure to perform offset for short-circuit test to remove stray resistance and bias due to the test leads and external environmental conditions.

In order to meet the specification of the device, offset for short-circuit test must be performed.



Note

In addition to perform user calibration through **SHORT TEST** page, user can perform user calibration through other methods.

1. by using the nSHORT signal of HANDLER.
2. by using the communication command [:AD]ust].

Since generated voltage signal will be very small (several mV at maximum) after the test current flows through the resistor in the condition of very small measuring resistance (3m $\Omega$  and 30m $\Omega$  ranges), the location, length and shape of the test leads may have influences on measuring.

In general, the location where measurement is performed is also the location where short circuit resetting is performed.

Example

Be sure to keep consistent of location when performing short circuit offsetting, especially when the range is 30m $\Omega$  or below in measurement.

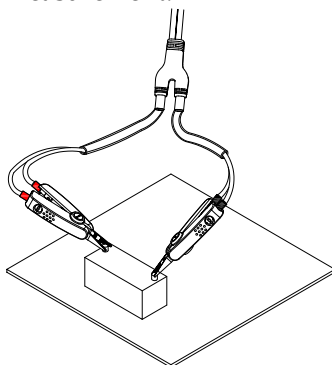

Connection method for offsetting

1. Connect H-SENSE and L-SENSE.
2. Connect H-SOURCE and L-SOURCE.
3. Connect SENSE and SOURCE to complete connection of 3 points.

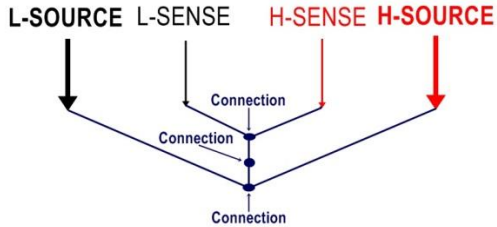

### Offsetting of test leads

GBM-01 TEST LEAD (Kelvin)

1. The SENSE terminal needs to be clipped on the same side to offset. (If offsetting is not performed on the same SENSE terminals, it may cause measurement error)

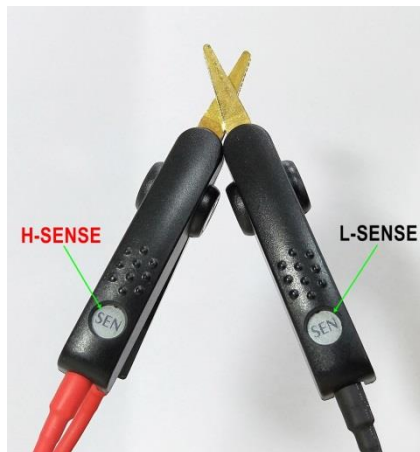

2. The SENSE terminals are clipped on the same side to complete connection of 3 points.



GBM-02 TEST  
LEAD (Single)

1. Refer to the connection method for offsetting to complete 3 points connection.

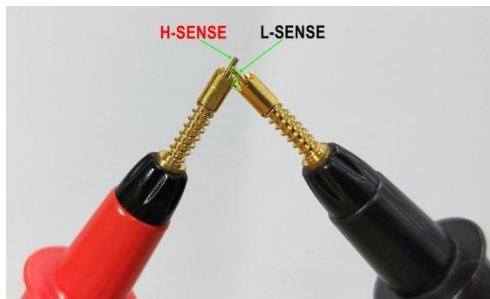

2. Find the short-circuit screw in the middle of the short-circuit board (GBM-S1) as center. Find two holes on left and right of the center which has the same distance between the two ends of the battery under test. Then insert the SENSE pins into the holes and press down the probes to let the SOURCE touch the copper foil on the PCB board to complete the 3-point connection. When performing offsetting, it is necessary to keep the probe and the short circuit board in good contact condition to avoid shaking and affect the measurement results.

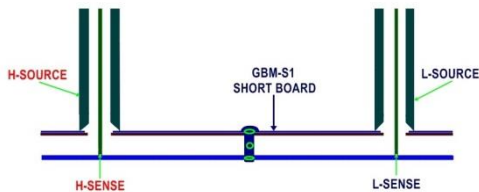
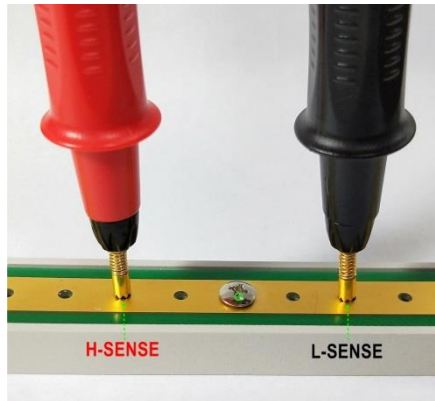

GBM-03 TEST  
LEAD (Twin)

1. Refer to the connection method for offsetting to complete 3 points connection.

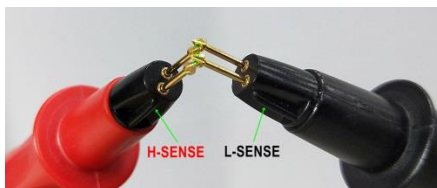

2. Find the short-circuit screw in the middle of the short-circuit board (GBM-S1) as center. Find two holes on left and right of the center which has the same distance between the two ends of the battery under test. Then insert the SENSE pins into the holes and press down the probes to let the SOURCE touch the copper foil on the PCB board to complete the 3-point connection. When performing offsetting, it is necessary to keep the probe and the short circuit board in good contact condition to avoid shaking and affect the measurement results.

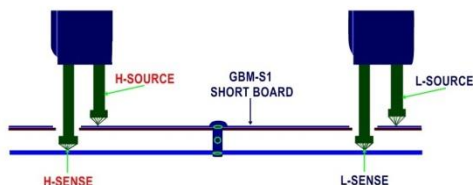
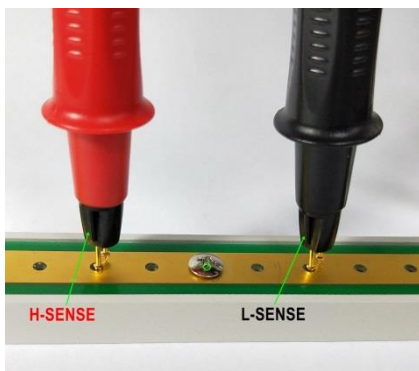

## Short-circuit test

Steps

1. Press the **Measure** button on the front panel.

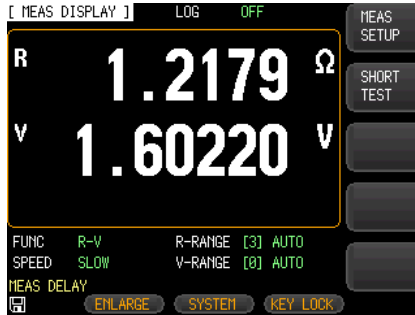
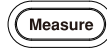

2. Press the **SHORT TEST** option key on the right of the LCD screen.



3. Use up and down arrow keys to select **SHORT TEST** on the [SHORT TEST] page.



4. Press the **MEAS SHORT** and then **OK** option key on the right of the LCD screen to perform short test. User can see the short measure is in progress. And finally a message “correction finished” displays on the lower part of the LCD screen.
5. If cursor on **SHORT TEST** is highlighted **OFF**, Press the **ON** option key on the right of the LCD screen first and then follow the step above to perform short test.

|                      |            |   |
|----------------------|------------|---|
| Available parameters | OFF        | Turn off the function of setting. The setting value is not used when testing.             |
|                      | MEAS SHORT | Perform short circuit reset. Connect the test clip before performing short circuit reset. |

Select Delay time 1. Use up and down arrow keys to select **DELAY** on the [SHORT TEST] page.

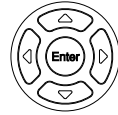

|                      |               |   |
|----------------------|---------------|---|
| Available parameters | OFF           | Perform short test without any delay.         |
|                      | 3s            | Perform short test after 3 seconds of delay.  |
|                      | 5s            | Perform short test after 5 seconds of delay.  |
|                      | 10s           | Perform short test after 10 seconds of delay. |
|                      | MEAS<br>SHORT | Perform short test.                           |



## Handler Overview

The device provides a full-featured handler interface that includes output signals of HI/OK/LO and EOM (end of test) for voltage and resistance, input signals of TRIG (activated by external trigger). Through this interface, the device can be easily controlled with the control components of user's system to complete automatic control functions.

## Terminal and signals

### Terminal

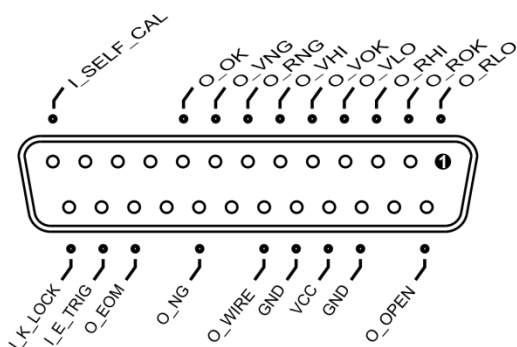

### Output terminal

| PIN No. | Name  | Description |
|---------|-------|-------------|
| 1       | O_RLO | 0: RLO      |
| 2       | O_ROK | 0: ROK      |
| 3       | O_RHI | 0: RHI      |
| 4       | O_VLO | 0: VLO      |
| 5       | O_VOK | 0: VOK      |
| 6       | O_VHI | 0: VHI      |
| 7       | O_RNG | 0: RNG      |
| 8       | O_VNG | 0: VNG      |

|    |        |                        |
|----|--------|------------------------|
| 9  | O_OK   | 0: RVOK                |
| 14 | O_OPEN | 0: OPEN                |
| 19 | O_WIRE | 0: WIRE                |
| 21 | O_NG   | 0: RVNG                |
| 23 | O_EOM  | 1: ON MEASING 0: READY |

### Input terminal

| PIN No. | Name     | Description                                   |
|---------|----------|---|
| 13      | SELF-CAL | 0: Self-calibration                           |
| 24      | TRIG     | Trigger input terminal. Rising edge is valid. |
| 25      | KEYLOCK  | 0: KEYLOCK 1: UNLOCK                          |

### Power source terminal

| PIN No. | Name | Description   |
|---------|------|---|
| 16,18   | GND  | GND ends for external power supply                  |
| 17      | VCC  | Positive end for internal VCC power supply (5V, 1A) |

### Connection

Please connect the external power supply to the following pins simultaneously:

Pin 16 and 18: GND ends for external power supply.

Pin 17: Floating.



Note

The device has built-in fully isolated power supply, so it is not necessary for external power supply to provide positive end.

## User internal power

When using internal power as power source, please connect p17 to VCC (5V) and device p16 and 18 to GND ends.

The internal power is 5V and 1A at maximum.

---



- In the case of unknown or uncertain power, the internal power cannot be used; otherwise the device will not work normally.
  - In the case of application of low-power, you can use the internal power supply to work, but it may make worse the ability of anti-interference of device.
- 

## Electrical parameters

---

- Power Requirements: + 3.3V ~ 30VDC
  - Output signal: output with built-in pull-up Darlington pair collector resistor. It is isolated with opt coupler and effective in low voltage level.
  - Maximum voltage: 30VDC with built-in 30V clamping circuit.
  - Input signal: It is isolated with opt coupler and effective in low voltage level.
  - Maximum current: 50mA
- 



- To avoid damaging the interface, the voltage of power supply voltage can't exceed the power requirements.
  - To avoid damaging the interface, please connect cable after the device is powered off.
  - The device uses output terminal derived by Darlington. It can drive small power relays and signal relays. The internal of device is integrated as reversed diode.
-

Schematic diagrams

At Input terminal

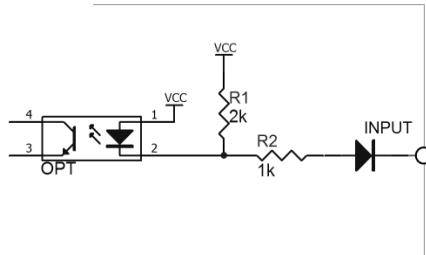

At output terminal

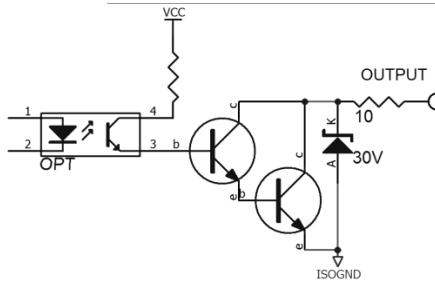

Connection method for input circuit

Connection with the switch

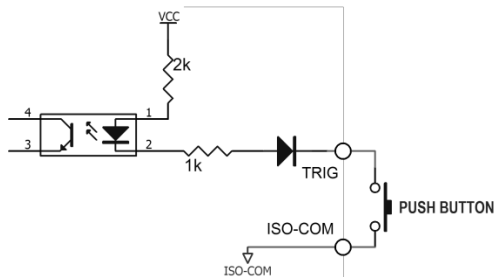

Connection by using relay to control

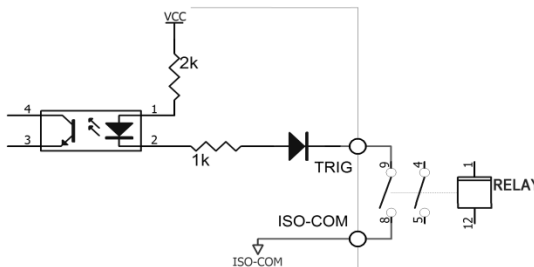

Connection by using PLC negative common terminal

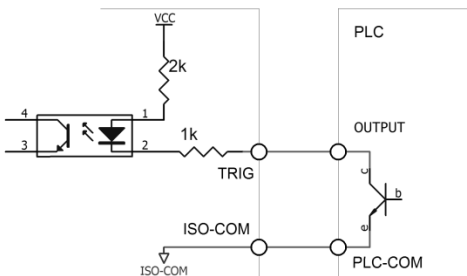

Connection by using PLC positive common terminal

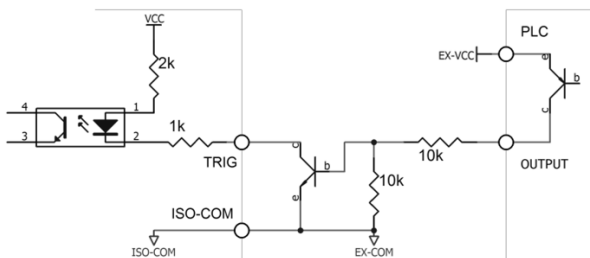

**Connection method for output circuit**

Control relay

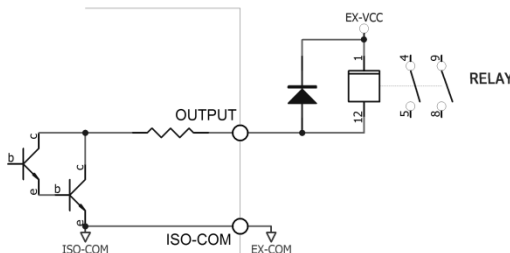

Control light-emitting diodes or opt couplers

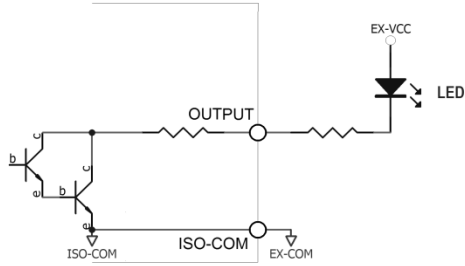

Negative logic output

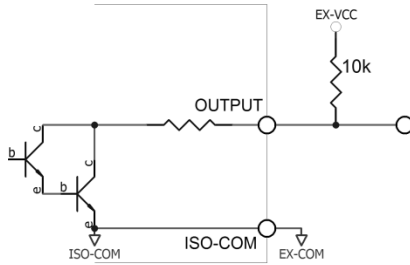

Two-port output and form a logic or circuit

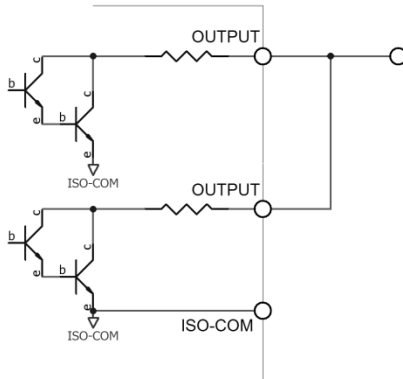

Output to PLC  
negative  
common  
terminal

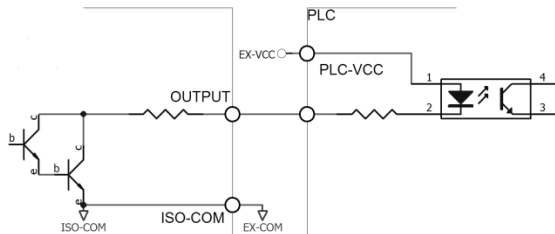

Output to PLC  
positive  
common  
terminal

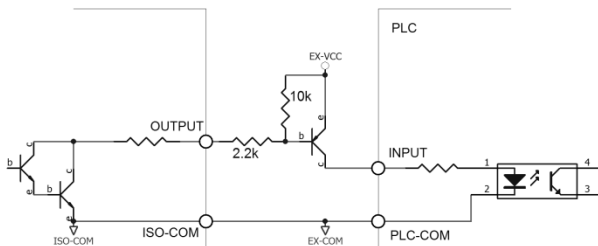

# REMOTE CONTROL

This chapter describes basic configuration of IEEE488.2 based remote control. For a command list, refer to the Command Overview chapter on page 108.

---

|  |     |
|--|-----|
| Configure Interface .....                              | 105 |
| RS-232C Interface.....                                 | 105 |
| Configure RS232 Interface .....                        | 106 |
| USB Interface .....                                    | 106 |
| Configure USB Interface .....                          | 107 |
| Install USB Driver .....                               | 108 |
| Configure related settings for remote control mode ... | 110 |
| Set up the stop bits.....                              | 110 |
| Set up transmission speed .....                        | 111 |
| Set up protocol .....                                  | 112 |
| Set up the style of sending result.....                | 113 |
| Set up terminator.....                                 | 114 |
| Set up hand shake function.....                        | 115 |



## Configure Interface

---

|           |  |                |
|-----------|--|----------------|
| Overview  | <p>The device uses the RS-232 interface or USB interface to communicate with the computer to complete all device's functions. With standard SCPI commands, users can easily create various acquisition system which are suitable for themselves.</p> <p>For more information on remote control programming, please see the Command Overview chapter on page 104.</p> |                |
| Interface | USB  | USB Device     |
|           | RS-232   | DB-9 male port |

### RS-232C Interface

RS-232 is the most widely used serial communication standard. It is also known as asynchronous serial communication standard which is used for data communication between computers and computers and peripherals. RS is an abbreviation for "Recommended Standard" and 232 is the standard number. This standard officially promulgated by the Electronic Industries Association (EIA) in 1969. It provides for the transmission of one bit of data via a data line each time.

In addition, RS232 also has the smallest subset which is also connection method used by the device.

The smallest subset for RS-232 connection

| Signal        | Symbol | Pin number (9-pin connector) |
|---------------|--------|------------------------------|
| Transmit Data | TXD    | 3                            |
| Receive Data  | RXD    | 2                            |
| Ground        | GND    | 5                            |

The RS-232 serial interface can be connected to the serial interface of a controller (PC or IPC) through a DB9 cable.



Note

- Only use a GWINSTEK (null modem) DB-9 cable.
- Cable length should not exceed 2 meters.
- To avoid electrical shock, turn off the power when plugging and unplugging the DB-9 cable.

## Configure RS232 Interface

|                                    |                       |  |
|------------------------------------|-----------------------|--|
| Default transmission configuration | Transmission method   | Full duplex asynchronous communication with start bit and stop bit |
|                                    | Parity                | None   |
|                                    | Hardware flow control | Off  |
|                                    | Data Bits             | 8  |
|                                    | Stop bit              | 1  |

RS232 Pin Assignments

Pin 2: RxD  
 Pin 3: TxD  
 Pin 5: GND  
 Pin 1, 4, 6 ~ 9: No Connection

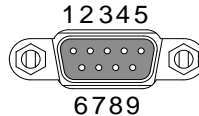

PC Connection Use a Null Modem connection as shown in the diagram below.

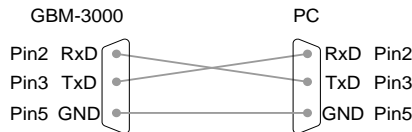

## USB Interface

On some newer computers, the RS232 interface has been removed and requires use of a USB interface for communication. The device is equipped with built-in USB-232 interface which can directly virtualize the USB port as an RS232 port in the computer.

This virtual port can perform the same functions as RS232 and use the same settings as the RS232 port. It supports USB2.0 and below version.

The USB device port on the rear panel is used for remote control. The USB port is configured as CDC interface.

When configured to CDC, the USB port on the GBM-3000 series will appear as a virtual COM port to a connected PC. Any terminal program that can communicate via a serial port can be used for remote control. Before the GBM-3000 series can be used for remote control using the CDC USB class, install the appropriate CDC USB driver included on the User Manual CD.

## Configure USB Interface

|            |   |
|------------|---|
| Background | The Type B USB port on the rear panel is used for remote control. This interface creates a virtual COM port when connected to a PC. |
|------------|---|



Note

The USB interface requires the USB driver to be installed. See page 108 to install the USB driver.

|                   |                           |                                   |
|-------------------|---------------------------|-----------------------------------|
| USB Configuration | PC connector              | Type A, host                      |
|                   | GBM-3000 series connector | Rear panel Type B, slave          |
|                   | Speed                     | 1.1/2.0 (full speed/high speed)   |
|                   | USB Class                 | CDC (Communications device class) |
|                   | Hardware flow control     | Off                               |
|                   | Data Bits                 | 8                                 |
| Stop bit          | 1                         |                                   |

## Install USB Driver

**Background**            The USB driver needs to be installed when using the USB port for remote control. The USB interface creates a virtual COM port when connected to a PC.

**Select the USB driver**            Configure the interface to USB in System>Utility>Interface menu.            Page

Connect the Type A-B USB cable to the rear panel USB B port on the GBM-3080/3300. Connect the other end to the Type A port on the PC.

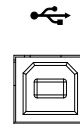

Go to the Windows Device Manager.  
 For Windows 7 go to:  
 Start Menu > Control Panel > Hardware and Sound > Device Manager  
 The GBM-3080/3300 will appear as an unknown Virtual Com Port under “Other Devices”.

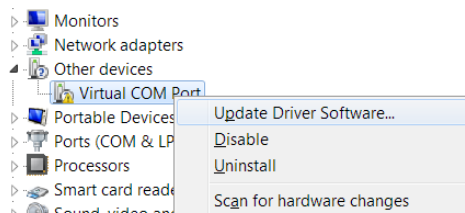

Right-click Other Devices and select “Update Driver Software”.

Select “Browse my computer for driver software” and select the driver on the User Manual CD.

The GBM-3080/3300 and the COM port that it is assigned to will now appear in under the Ports (COM & LPT) node.

**Note**

- If the driver for the device can't be installed automatically, please use the CD comes with the device to install. Click on the directory: USB Drive
  - To avoid electrical shock, turn off the power when plugging and unplugging the DB9 cable.
  - If the driver installation is completed correctly, the number of USB serial port will be displayed.
  - You need to remember this port number because you will use it when programming.
  - Both SCPI commands and Modbus commands can be operated through RS-232C or USB port.
-

## Configure related settings for remote control mode

### Set up the stop bits

**Steps**

1. Press **SYSTEM** key below the LCD screen to enter [SYSTEM CONFIG] setting page.
2. Use up and down arrow keys to select **STOP BITS** on this setting page. The selected item will be highlighted.

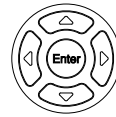

3. Press option key on the right of the LCD screen to change setting.

**Available parameter**

- 1-BIT In general, stop bits is set to one bit.
- 2-BITS Stop bits is set to two bit.

## Set up transmission speed

### Steps

1. Press **SYSTEM** key below the LCD screen to enter [SYSTEM CONFIG] setting page.
2. Use up and down arrow keys to select **BAUD** on this setting page. The selected item will be highlighted.

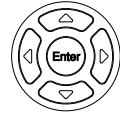

3. Press option key on the right of the LCD screen to change setting.

|                     |        |   |
|---------------------|--------|---|
| Available parameter | 1200   | Use this serial transfer rate if you use a communications converter with opt coupler isolation.               |
|                     | 9600   | 9600bps   |
|                     | 38400  | 38400bps  |
|                     | 57600  | 57600bps  |
|                     | 115200 | It is recommended that you use this high-speed serial transmission speed to communicate with a host computer. |

## Set up protocol

- Steps
1. Press **SYSTEM** key below the LCD screen to enter [SYSTEM CONFIG] setting page.
  2. Use up and down arrow keys to select **PROTOCOL** on this setting page. The selected item will be highlighted.

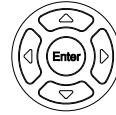

3. Press option key on the right of the LCD screen to change setting.

|                     |      |               |
|---------------------|------|---------------|
| Available parameter | SCPI | SCPI protocol |
|---------------------|------|---------------|



## Set up the style of sending result

If the Result setting is set to Auto, the device will automatically send out the measurement results each time a test is finished. This kind of setting is convenient especially when the device is working with a sorting machine. The device will start a test after receiving the trigger signal and then returns the test result to the sorting machine without the need to receive a “fetch?” command from either the sorting machine or the control PC.

### Steps

1. Press **SYSTEM** key below the LCD screen to enter [SYSTEM CONFIG] setting page.
2. Use up and down arrow keys to select **RESULT** on this setting page. The selected item will be highlighted.

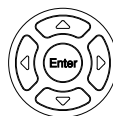

3. Press option key on the right of the LCD screen to change setting.

### Available parameter

- |       |  |
|-------|--|
| FETCH | The device will not send out the test result after the test. |
| AUTO  | The device will send out the test result after the test.     |

## Set up terminator

There must be terminator in the communication command between the device and the host, so as to facilitate mutual recognition of the end of the command.

The device supports four kinds of terminator.

### Steps

1. Press **SYSTEM** key below the LCD screen to enter [SYSTEM CONFIG] setting page.
2. Use up and down arrow keys to select **TERMINATOR** on this setting page. The selected item will be highlighted.

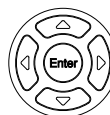

3. Press option key on the right of the LCD screen to change setting.

### Available parameter

- |           |   |
|-----------|---|
| LF(0x0A)  | One byte of terminator for line feed.                               |
| CR(0x0D)  | One byte of terminator for carriage return.                         |
| CR+LF     | Two bytes of terminator. First byte is 0x0D and second one is 0x0A. |
| NUL(0x00) |   |

---

Default parameter                      CR+LF

### Set up hand shake function

Because the device uses the smallest subset of the RS-232 standard and doesn't use hand shake signals for hardware, the device can activate hand shake for software in order to reduce possible data loss or data errors in communications. Software engineers of high level language should be strict to the following hand shake agreement to establish compilation of computer communication software:

---

Handshake agreement

- The command line parser of the device only accepts ASCII format and the response to command also returns in ASCII code.
  - The command string sent by the host must end with a terminator. The command line parser of the device starts executing the command string only after receiving the terminator.
  - When the device is set to enable **handshake** command, the device will send the character back to the host immediately after each character is received. The host can send the next character only after receiving the returned character.
-



**Note**

If the host can't accept the data returned by the device, you can use the following methods to try to solve:

- The hand shake function is disabled. Please enable the hand shake function. Refer to the text below for hand shake setting.
- Failure of serial connection. Please check the cable connection.
- Communication format for high level language program error. Please check if the serial port number, communication format are correct and the serial transmission rate is the same as the device setting.
- If the device is resolving the last command, the host can't accept the response of the device. Please try again later.

**Steps**

1. Press **SYSTEM** key below the LCD screen to enter [SYSTEM CONFIG] setting page.
2. Use up and down arrow keys to select **HAND SHAKE** on this setting page. The selected item will be highlighted.

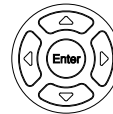

- 
3. Press option key on the right of the LCD screen to change setting.
- 

Available  
parameter

OFF     It is not necessary to use SHAKhand command. If no special requirements, please set the command to off.

ON

---



Note

After the instruction exchange is turned on, all the commands which sent by the host to the instrument returns to the host computer as the same before returning the data.

After the command handshaking is turned off, the commands sent by the host to the instrument will be processed immediately.

---

# C **COMMAND OVERVIEW**

The Command overview chapter lists all programming commands in functional order as well as alphabetical order. The command syntax section shows you the basic syntax rules you have to apply when using commands.

---

|                     |     |
|---------------------|-----|
| Command Syntax..... | 119 |
| Command List.....   | 123 |

## Command Syntax

|                     |            |                       |
|---------------------|------------|-----------------------|
| Compatible Standard | IEEE488.2  | Partial compatibility |
|                     | SCPI, 1994 | Partial compatibility |

**Command Structure**

SCPI (Standard Commands for Programmable Instruments) commands follow a tree-like structure, organized into nodes. Each level of the command tree is a node. Each keyword in a SCPI command represents each node in the command tree. Each keyword (node) of a SCPI command is separated by a colon (:). For example, the diagram below shows an SCPI sub-structure and a command example.

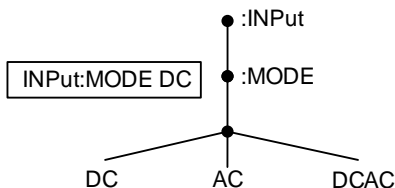

**Command Types**

There are a number of different instrument commands and queries. A command sends instructions or data to the unit and a query receives data or status information from the unit.

### Command types

**Simple**                      A single command with/without a parameter

**Example**                      :INPut:MODE DC

Query                    A query is a simple or compound command followed by a question mark (?). A parameter (data) is returned.

Example                :INPut:CFACTOR?

**Command Forms**      Commands and queries have two different forms, long and short. The command syntax is written with the short form of the command in capitals and the remainder (long form) in lower case.

The commands can be written either in capitals or lower-case, just so long as the short or long forms are complete. An incomplete command will not be recognized.

Below are examples of correctly written commands.

Long form             :INPut:SYNChronize VOLTage  
                              :COMMunicate:HEADer ON

Short form            :INP:SYNC VOLT  
                              :COMM:HEAD ON

**Square Brackets**    Commands that contain square brackets indicate that the contents are optional. The function of the command is the same with or without the square bracketed items, as shown below. For example, the query:

[:INPut]:FILTer?

Both :INPut:FILTer? and :FILTer? are valid forms.





1. Command header
2. Space
3. Parameter 1

| Common Input Parameters | Type                          | Description   | Example         |
|-------------------------|-------------------------------|---|-----------------|
|                         | <Boolean>                     | Boolean logic   | 0, 1            |
|                         | <NR1>                         | integers  | 0, 1, 2, 3      |
|                         | <NR2>                         | decimal numbers   | 0.1, 3.14, 8.5  |
|                         | <NR3>                         | floating point with exponent  | 4.5e-1, 8.25e+1 |
|                         | <NRf>                         | any of NR1, 2, 3  | 1, 1.5, 4.5e-1  |
|                         | [MIN]<br>(Optional parameter) | For commands, this will set the setting to the lowest value. This parameter can be used in place of any numerical parameter where indicated.<br><br>For queries, it will return the lowest possible value allowed for the particular setting.   |                 |
|                         | [MAX]<br>(Optional parameter) | For commands, this will set the setting to the highest value. This parameter can be used in place of any numerical parameter where indicated.<br><br>For queries, it will return the highest possible value allowed for the particular setting. |                 |

Message Terminator (EOL)      Remote Command      Marks the end of a command line. The following messages are in accordance with IEEE488.2 standard.

CR+LF

The most  
common EOL  
character is  
CR+LF

---

Message  
Separator

EOL or ;  
(semicolon)

Command Separator

---

## Command List

---

|            |                                 |     |
|------------|---------------------------------|-----|
| DISPlay    | :DISPlay:PAGE.....              | 126 |
| Commands   | :DISPlay:LINE .....             | 126 |
| DISPlay    | :FUNcTion .....                 | 128 |
| Commands   | :FUNcTion: MONitor.....         | 128 |
| RESistance | :RESistance:RANGe .....         | 130 |
| Commands   | :RESistance:RANGe:NO .....      | 130 |
|            | :RESistance:RANGe:MODE .....    | 131 |
|            | :RESistance:LiMiT .....         | 131 |
|            | :RESistance:LiMiT:STATe .....   | 132 |
|            | :RESistance:LiMiT:MODE .....    | 132 |
|            | :RESistance:LiMiT:NOMinal ..... | 133 |
|            | :RESistance:LiMiT:SEQ .....     | 133 |
|            | :RESistance:LiMiT:ABS .....     | 134 |
|            | :RESistance:LiMiT:PER.....      | 134 |
| VOLTage    | :VOLTage:RANGe.....             | 136 |
| Commands   | :VOLTage:RANGe:NO .....         | 136 |
|            | :VOLTage:RANGe:MODE.....        | 137 |
|            | :VOLTage:LiMiT .....            | 137 |
|            | :VOLTage:LiMiT:STATe .....      | 138 |
|            | :VOLTage:LiMiT:MODE .....       | 138 |
|            | :VOLTage:LiMiT:NOMinal .....    | 139 |
|            | :VOLTage:LiMiT:SEQ .....        | 139 |
|            | :VOLTage:LiMiT:ABS .....        | 140 |
|            | :VOLTage:LiMiT:PER.....         | 140 |
| AUTorange  | :AUTorange .....                | 141 |
| Command    |                                 |     |
| ADJust     | :ADJust:CLEAr .....             | 142 |
| Commands   | :ADJust .....                   | 142 |
| SAMPlE     | :SAMPlE:RATE .....              | 143 |
| Commands   | :SAMPlE:AVERAge.....            | 143 |

|           |  |     |
|-----------|--|-----|
| CALCulate | :CALCulate:AVERAge:STATe.....                    | 144 |
| Commands  | :CALCulate:AVERAge.....                          | 145 |
|           | :CALCulate:LIMit:STATe.....                      | 145 |
|           | :CALCulate:LIMit:BEEPer.....                     | 146 |
|           | :CALCulate:LIMit:RESistance:MODE.....            | 146 |
|           | :CALCulate:LIMit:RESistance:UPPer.....           | 147 |
|           | :CALCulate:LIMit:RESistance:LOWer.....           | 148 |
|           | :CALCulate:LIMit:RESistance:REFerence.....       | 148 |
|           | :CALCulate:LIMit:RESistance:PERCent.....         | 149 |
|           | :CALCulate:LIMit:VOLTagE:MODE.....               | 149 |
|           | :CALCulate:LIMit:VOLTagE:UPPer.....              | 150 |
|           | :CALCulate:LIMit:VOLTagE:LOWer.....              | 151 |
|           | :CALCulate:LIMit:VOLTagE:REFerence.....          | 151 |
|           | :CALCulate:LIMit:VOLTagE:PERCent.....            | 152 |
|           | :CALCulate:LIMit:ABS.....                        | 152 |
|           | :CALCulate:STATistics[:STATe].....               | 153 |
|           | :CALCulate:STATistics:RESistance:NUMBer?.....    | 153 |
|           | :CALCulate:STATistics:RESistance:MEAN?.....      | 154 |
|           | :CALCulate:STATistics:RESistance:MAXimum?.....   | 154 |
|           | :CALCulate:STATistics:RESistance:MINimum?.....   | 154 |
|           | :CALCulate:STATistics:RESistance:LiMit?.....     | 155 |
|           | :CALCulate:STATistics:RESistance:DEVIation?..... | 155 |
|           | :CALCulate:STATistics:RESistance:CP?.....        | 156 |
|           | :CALCulate:STATistics:VOLTagE:NUMBer?.....       | 156 |
|           | :CALCulate:STATistics:VOLTagE:MEAN?.....         | 156 |
|           | :CALCulate:STATistics:VOLTagE:MAXimum?.....      | 157 |
|           | :CALCulate:STATistics:VOLTagE:MINimum?.....      | 157 |
|           | :CALCulate:STATistics:VOLTagE:LiMit?.....        | 157 |
|           | :CALCulate:STATistics:VOLTagE:DEVIation?.....    | 158 |
|           | :CALCulate:STATistics:VOLTagE:CP?.....           | 158 |
|           | <br>   |     |
| LOGger    | :LOGger[:STATe].....                             | 160 |
| Commands  | :LOGger:START.....                               | 160 |
|           | :LOGger:SIZE.....                                | 161 |
|           | :LOGger:COUNt.....                               | 161 |
|           | :LOGger:DATA?.....                               | 161 |
| <br>      |  |     |
| SYSTem    | :SYSTem:TIME.....                                | 163 |
| Commands  | :SYSTem:KEYLock.....                             | 163 |
|           | :SYSTem:CODE.....                                | 164 |
|           | :SYSTem:BEEPer.....                              | 164 |

|               |                                |     |
|---------------|--------------------------------|-----|
|               | :SYSTem:CURRent .....          | 165 |
|               | :SYSTem:CALibration .....      | 165 |
|               | :SYSTem:CALibration:AUTO ..... | 166 |
|               | :SYSTem:RESult .....           | 166 |
|               | :SYSTem:DATAout .....          | 166 |
|               | :SYSTem:BACKUp .....           | 167 |
| TRIGger       | :TRIGger:SOURce.....           | 168 |
| Commands      | :TRIGger:DELAy .....           | 168 |
|               | :TRIGger:DELAy:STATe .....     | 169 |
|               | :TRG.....                      | 169 |
| FETCh(READ)   | :FETCh? .....                  | 170 |
| Commands      | :FETCh:FULL.....               | 171 |
| CORRection    | :CORRection:SHORt.....         | 172 |
| Command       |                                |     |
| FILE(MMEM)    | :FILE:SAVE .....               | 173 |
| Commands      | :FILE:LOAD .....               | 173 |
|               | :FILE:DELEte .....             | 173 |
| SPCI Commands | *IDN? .....                    | 175 |
|               | *ERRor?.....                   | 176 |
|               | *SAV .....                     | 176 |

## DISPlay Commands

|                     |     |
|---------------------|-----|
| :DISPlay:PAGE.....  | 126 |
| :DISPlay:LINE ..... | 126 |

### :DISPlay:PAGE

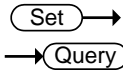

|                  |  |  |
|------------------|--|--|
| Description      | Sets or returns the specified page.          |  |
| Syntax           | :DISPlay:PAGE <Page name>                    |  |
| Query Syntax     | :DISP:PAGE?                                  |  |
| Parameter        | <Page name>                                  | {MEAS DIPLSY[MEAS], ENALRGE[ENLA], SETUP[MSET], COMP SETUP[BSET], SHORT TEST[CSET], FILE[CATA], SYSTEM CONFIG[SYST], SYSTEM INFORMATION[SINF]} |
| Return parameter | <Page name> abbreviation                     | Meas enla mset bset cset cata syst sinf  |
| Example          | ->:DISP:PAGE MSET<br>->:DISP:PAGE?<br>->mset |  |

### :DISPlay:LINE

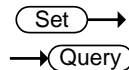

|              |   |                      |
|--------------|---|----------------------|
| Description  | Sets or returns a string of text at prompt field of the page. The text can display up to 30 characters and the text stays on the screen for 10 seconds. |                      |
| Syntax       | :DISPlay:LINE <string>  |                      |
| Query Syntax | :DISPlay:LINE?  |                      |
| Parameter    | <string>  | 30 character at most |
| Example      | ->DISP:LINE "This is a comment."<br>->:DISP:LINE?<br>->This is a comment  |                      |

---

Note                      NULL will be returned if the prompt field is empty.

---

## FUNCTION Commands

|                         |     |
|-------------------------|-----|
| :FUNCTION.....          | 128 |
| :FUNCTION: MONitor..... | 128 |

:FUNCTION 

|                  |  |   |
|------------------|--|---|
| Description      | Sets or returns the measurement parameter  |   |
| Syntax           | :FUNCTION {RV, RESistance(R), VOLTage (V)} |   |
| Query Syntax     | :FUNCTION?                                 |   |
| Parameter/       | RV   | Select resistance and voltage as measurement parameter. |
|                  | RESistance or R                            | Select resistance as measurement parameter.             |
|                  | VOLTage or V                               | Select voltage as measurement parameter.                |
| Return parameter | RV   | Measurement parameters are voltage and resistance.      |
|                  | RESISTANCE                                 | Measurement parameter is resistance.                    |
|                  | VOLTAGE                                    | Measurement parameter is voltage.                       |
| Example          | ->: FUNC RES<br>->: FUNC?<br>->RESISTANCE  |   |

:FUNCTION: MONitor 

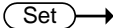

|                  |   |  |
|------------------|---|--|
| Description      | Sets or returns the monitor parameter   |  |
| Syntax           | :FUNCTION {OFF, RABS, RPER, VABS, VPER} |  |
| Query Syntax     | :FUNCTION?                              |  |
| Parameter/       | OFF                                     | Disable the monitor function.                        |
| Return parameter | RABS                                    | Monitor the resistance absolute deviation (RΔ) value |



---

|      |  |
|------|--|
| RPER | Monitor the resistance relative deviation (R%) value |
| VABS | Monitor the voltage absolute deviation (VΔ) value    |
| VPER | Monitor the voltage relative deviation (V%) value    |

---

Example

```
->: FUNC:MON RPER
->: FUNC:MON?
->RPER
```

---

## RESistance Command

|                                |     |
|--------------------------------|-----|
| :RESistance:RANGe.....         | 130 |
| :RESistance:RANGe:NO .....     | 130 |
| :RESistance:RANGe:MODE.....    | 131 |
| :RESistance:LiMiT .....        | 131 |
| :RESistance:LiMiT:STATe .....  | 132 |
| :RESistance:LiMiT:MODE .....   | 132 |
| :RESistance:LiMiT:NOMinal..... | 133 |
| :RESistance:LiMiT:SEQ .....    | 133 |
| :RESistance:LiMiT:ABS .....    | 134 |
| :RESistance:LiMiT:PER.....     | 134 |

:RESistance:RANGe (Set) →  
→ (Query)

|                  |  |   |
|------------------|--|---|
| Description      | Sets and returns the resistance range according to the resistance value. |   |
| Syntax           | :RESistance:RANGe <0 ~ 3100>   |   |
| Query Syntax     | :RESistance:RANGe?   |   |
| Parameter        | <0 ~ 3100>   | Floating point with exponent represents the resistance value                      |
| Return parameter |  | 3.0000E-3, 30.000E-3, 300.00E-3,<br>3.0000E+0, 30.000E+0, 300.00E+0,<br>3.0000E+3 |
| Example          | ->:RES:RANG 100E-3<br>->:RES:RANG?<br>->100.00E -3                       |   |

:RESistance:RANGe:NO (Set) →  
→ (Query)

|              |   |  |
|--------------|---|--|
| Description  | Sets and returns the range number for resistance. |  |
| Syntax       | :RESistance:RANGe:NO{<Range no.>, min, max}       |  |
| Query Syntax | :RESistance:RANGe:NO?                             |  |

|                  |  |  |
|------------------|--|--|
| Parameter        | <0 to 6>                                   | Range no.                              |
|                  | min  | The minimum range. Range no. is 0(3mΩ) |
|                  | max  | The maximum range. Range no. is 6(3kΩ) |
| Return parameter | <0 to 6>                                   |  |
| Example          | ->:RES:RANG:NO 3<br>->:RES:RANG:NO?<br>->3 |  |

Set →  
 → Query

|                              |  |                                      |
|------------------------------|--|--------------------------------------|
| Description                  | Sets and returns the range mode for resistance.      |                                      |
| Syntax                       | :RESistance:RANGe:MODE {AUTO, HOLD, NOMinal}         |                                      |
| Query Syntax                 | :RESistance:RANGe:MODE?                              |                                      |
| Parameter / Return parameter | AUTO   | Automatically select the best range. |
|                              | HOLD   | User specified range.                |
|                              | NOM  | Range on the nominal value.          |
| Example                      | ->:RES:RANG:MODE AUTO<br>->:RES:RANG:MODE?<br>->AUTO |                                      |

**Note**

If the range mode is set to NOM, the device will set the range according to the mode of comparator.

When the comparator mode is SEQ, the range will be set according to the upper limit of the comparator.

When the comparator mode is ABS and PER, the range will be set according to the nominal value.

Set →  
 → Query

|                          |   |  |
|--------------------------|---|--|
| <b>:RESistance:LiMiT</b> |   |  |
| Description              | Sets and returns the upper and lower limit of resistance for the current comparison mode. |  |
| Syntax                   | :RESistance:LiMiT <lower, upper>  |  |

|                                 |  |   |
|---------------------------------|--|---|
| Query Syntax                    | :RESistance:LiMiT?   |   |
| Parameter /<br>Return parameter | lower  | The lower limit of floating point with exponent |
|                                 | upper  | The upper limit of floating point with exponent |
| Note                            | The data value corresponds to the current comparison mode. The value represents resistance ( $\Omega$ ) when comparison mode is directly readout SEQ and ABS and expressed as a percentage value % when comparison mode is percentage (PER). |   |
| Example                         | ->:RES:LMT 10m, 100m<br>->:RES:LMT?<br>-> +10.000E-3, +100.000E-3  |   |

Set →

→ Query

**:RESistance:LiMiT:STATe**

|                                 |  |                                   |
|---------------------------------|--|-----------------------------------|
| Description                     | Set and returns the resistance comparator state. |                                   |
| Syntax                          | :RESistance:LiMiT:STATe{ON/1, OFF/0}             |                                   |
| Query Syntax                    | :RESistance:LiMiT:STATe?                         |                                   |
| Parameter /<br>Return parameter | ON   | Enable the resistance comparator  |
|                                 | OFF  | Disable the resistance comparator |
| Example                         | ->:RES:LMT:STAT OFF<br>->:RES:LMT:STAT?<br>->OFF |                                   |

Set →

→ Query

**:RESistance:LiMiT:MODE**

|                                 |   |   |
|---------------------------------|---|---|
| Description                     | Sets and returns comparison mode for resistance |   |
| Syntax                          | :RESistance:LiMiT:MODE{SEQ, PER, ABS}           |   |
| Query Syntax                    | :RESistance:LiMiT:MODE?                         |   |
| Parameter /<br>Return parameter | SEQ   | Comparison with current readout of upper and lower limit. |

|     |   |
|-----|---|
| PER | Comparison with percentage(Relative deviation comparison) |
| ABS | Comparison with absolute deviation ( $\Delta$ )           |

Example  
 ->:RES:LMT:MODE PER  
 ->:RES:LMT:MODE?  
 ->PER

Set →  
 → Query

**:RESistance:LiMiT:NOMinal**

**Description**      Sets and returns the nominal value for the resistor. The nominal value is only operated in ABS and PER mode.

**Syntax**            :RESistance:LiMiT:NOMinal <float>0 ~ 3200

**Query Syntax**    :RESistance:LiMiT:NOMinal?

|                                     |                       |  |
|-------------------------------------|-----------------------|--|
| <b>Parameter / Return parameter</b> | <b>Floating point</b> | Floating point of nominal value. It's unit is $\Omega$ |
|-------------------------------------|-----------------------|--|

Example  
 ->:RES:LMT:NOM 12.345m  
 ->:RES:LMT:NOM?  
 ->+12.345E-3

**Note**              If the current resistance range is set to NOM and the comparison mode for resistance is PER or ABS, the resistance range will be shifted to the optimum range based on the nominal value.

                      However, when the comparison mode for resistance is SEQ, the range will not be shifted according to the nominal value. (range is selected according to the upper limit in SEQ mode.)

Set →  
 → Query

**:RESistance:LiMiT:SEQ**

**Description**      Sets and returns the upper and lower limit for the resistance on the current readout compassion mode.

**Syntax**            :RESistance:LiMiT:SEQ<lower, upper> 0 ~ 3200

|                                 |   |                                   |
|---------------------------------|---|-----------------------------------|
| Query Syntax                    | :RESistance:LiMiT:SEQ?  |                                   |
| Parameter /<br>Return parameter | Lower   | The lower limit of floating point |
|                                 | upper   | The upper limit of floating point |
| Example                         | ->:RES:LMT:SEQ 1m, 10m<br>->:RES:LMT:SEQ?<br>->+1.0000E-3, +10.000E-3   |                                   |
| Note                            | :RESistance:LiMiT:SEQ command will shift the comparison mode for resistance to SEQ mode.<br>However, RESistance:LiMiT:SEQ? command doesn't shift the comparison mode. |                                   |

Set →

→ Query

**:RESistance:LiMiT:ABS**

|                                 |   |                                   |
|---------------------------------|---|-----------------------------------|
| Description                     | Set the upper and lower limits for the resistance on the current absolute compassion mode.  |                                   |
| Syntax                          | :RESistance:LiMiT:ABS<lower, upper>-3200 ~ 3200   |                                   |
| Query Syntax                    | :RESistance:LiMiT:ABS?  |                                   |
| Parameter /<br>Return parameter | Lower   | The lower limit of floating point |
|                                 | upper   | The upper limit of floating point |
| Example                         | ->:RES:LMT:ABS -1.23m, 1.23m<br>->:RES:LMT:ABS?<br>->-1.2300E-3, +1.2300E-3   |                                   |
| Note                            | :RES:LMT:ABS command will switch the comparison mode for resistance to ABS mode.<br>:RES:LMT:ABS? Command doesn't switch the comparison mode. |                                   |

Set →

→ Query

**:RESistance:LiMiT:PER**

|             |   |  |
|-------------|---|--|
| Description | Sets and returns the percentage of the upper and lower limits for the resistance on the current percentage compassion mode. |  |
| Syntax      | :RESistance:LiMiT:PER<lower, upper> -100 ~ 100  |  |

|                                 |   |                                   |
|---------------------------------|---|-----------------------------------|
| Query Syntax                    | :RESistance:LiMiT:PER?  |                                   |
| Parameter /<br>Return parameter | Lower   | The lower limit of floating point |
|                                 | upper   | The upper limit of floating point |
| Example                         | ->:RES:LMT:PER -10, 10<br>->:RES:LMT:PER?<br>->-10.000E+0, +10.000E+0   |                                   |
| Note                            | :RES:LMT:PER command will shift the comparison mode for resistance to PER mode.<br>:RES:LMT:PER? Command doesn't shift the comparison mode. |                                   |

## VOLTage Commands

|                              |     |
|------------------------------|-----|
| :VOLTage:RANGe.....          | 136 |
| :VOLTage:RANGe:NO.....       | 136 |
| :VOLTage:RANGe:MODE.....     | 137 |
| :VOLTage:LiMiT .....         | 137 |
| :VOLTage:LiMiT:STATe .....   | 138 |
| :VOLTage:LiMiT:MODE .....    | 138 |
| :VOLTage:LiMiT:NOMinal ..... | 139 |
| :VOLTage:LiMiT:SEQ.....      | 139 |
| :VOLTage:LiMiT:ABS .....     | 140 |
| :VOLTage:LiMiT:PER.....      | 140 |

### :VOLTage:RANGe

|                  |  |  |
|------------------|--|--|
| Description      | Sets and returns the voltage range according to the voltage value. |  |
| Syntax           | :VOLTage:RANGe <0 ~ 300>   |  |
| Query Syntax     | :VOLTage:RANGe?  |  |
| Parameter        | <0 ~ 300>  | Float point represents the voltage value |
| Return parameter |  | 8.00000E+0, 80.0000E+0 , 300.000E+0      |
| Example          | ->:VOLT:RANG 10<br>->:VOLT:RANG?<br>->10.0000E+0                   |  |

### :VOLTage:RANGe:NO

|              |  |  |
|--------------|--|--|
| Description  | Sets and returns the range number for voltage. |  |
| Syntax       | :VOLTage:RANGe:NO{<Range no.>, min, max}       |  |
| Query Syntax | :VOLTage:RANGe:NO?                             |  |
| Parameter    | <0 to 2>                                       | Range no.                                |
|              | min  | The minimum range. Range no. is 0 (8V)   |
|              | max  | The maximum range. Range no. is 2 (300V) |



Return parameter <0 to 2>

Example ->:VOLT:RANG:NO 1  
 ->:VOLTRANG:NO?  
 ->1

**:VOLTage:RANGe:MODE**

Set →

→ Query

Description Sets and returns the range mode for voltage.

Syntax :VOLTage:RANGe:MODE{AUTO, HOLD, NOMinal}

Query Syntax :VOLTage:RANGe:MODE?

|                              |      |                                      |
|------------------------------|------|--------------------------------------|
| Parameter / Return parameter | AUTO | Automatically select the best range. |
|                              | HOLD | User specified range.                |
|                              | NOM  | Range on the nominal value.          |

Example ->:VOLT:RANG:MODE AUTO  
 ->:VOLT:RANG:MODE?  
 ->AUTO

Note If set to NOM mode, the device will set the range according to the mode of comparator.  
 When the comparator mode is SEQ, the range will be set according to the upper limit of the comparator.  
 When the comparator mode is ABS and PER, the range will be set according to the nominal value.

**:VOLTage:LiMiT**

Set →

→ Query

Description Sets and returns the upper and lower limits of voltage of the current comparison mode.

Syntax :VOLTage:LiMiT<lower, upper> 0 ~ 303

Query Syntax :VOLTage:LiMiT?

|                              |       |                                   |
|------------------------------|-------|-----------------------------------|
| Parameter / Return parameter | lower | The lower limit of floating point |
|                              | upper | The upper limit of floating point |

Example           ->:VOLT:LMT 10, 20  
                   ->:VOLT:LMT?  
                   ->-10.0000E+0, +20.0000E+0

**:VOLTage:LiMiT:STATe**

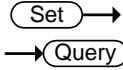

Description       Sets and returns the voltage comparator state.

Syntax            :VOLTage:LiMiT:STATe{ON/1, OFF/0}

Query Syntax     :VOLTage:LiMiT:STATe?

|                                 |     |                                   |
|---------------------------------|-----|-----------------------------------|
| Parameter /<br>Return parameter | ON  | Enable the resistance comparator  |
|                                 | OFF | Disable the resistance comparator |

Example           ->:VOLT:LMT:STAT OFF  
                   ->:VOLT:LMT:STAT?  
                   ->OFF

**:VOLTage:LiMiT:MODE**

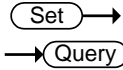

Description       Set comparison mode for voltage

Syntax            :VOLTage:LiMiT:MODE{SEQ, PER, ABS}

Query Syntax     :VOLTage:LiMiT:MODE?

|                                 |     |  |
|---------------------------------|-----|--|
| Parameter /<br>Return parameter | SEQ | Comparison with current readout of upper and lower limits. |
|                                 | PER | Comparison with percentage(Relative deviation comparison)  |
|                                 | ABS | Comparison with absolute deviation ( $\Delta$ )            |

Example           ->:VOLT:LMT:MODE PER  
                   ->:VOLT:LMT:MODE?  
                   ->PER

Set →  
 → Query

---

| :VOLTage:LiMiT:NOMinal       |   |
|------------------------------|---|
| Description                  | Sets and returns the nominal value for the voltage, nominal value is only operated in ABS and PER mode.   |
| Syntax                       | :VOLTage:LiMiT:NOMinal<float> -303 ~ 303  |
| Query Syntax                 | :VOLTage:LiMiT:NOMinal?   |
| Parameter / Return parameter | Floating point      Floating point of nominal value. It's unit is V.  |
| Example                      | ->:VOL:LMT:NOM 12.345m<br>->:VOL:LMT:NOM?<br>->+12.3450E-3  |
| Note                         | <p>If the current voltage range is set to NOM and the comparison mode for voltage is PER or ABS, the voltage range will be shifted to the optimum range based on the nominal value.</p> <p>However, when the comparison mode for voltage is set to SEQ, the range will not be shifted according to the nominal value. (range is selected according to the upper limit in SEQ mode.)</p> |

Set →  
 → Query

---

| :VOLTage:LiMiT:SEQ           |   |
|------------------------------|---|
| Description                  | Sets and returns the upper and lower limits for the voltage on the current readout compassion mode. |
| Syntax                       | :VOLTage:LiMiT:SEQ<lower, upper> -303 ~ 303   |
| Query Syntax                 | :VOLTage:LiMiT:SEQ?   |
| Parameter / Return parameter | Lower      The lower limit of floating point<br>upper      The upper limit of floating point        |
| Example                      | ->:VOLT:LMT:SEQ 1.23456, 3.45678<br>->:VOLT:LMT:SEQ?<br>->+1.23456E+0, +3.45678E+0                  |

Note :VOLTage:LiMiT:SEQ command will shift the comparison mode for voltage to SEQ mode.  
 However, :VOLTage:LiMiT:SEQ? command doesn't shift the comparison mode.



:VOLTage:LiMiT:ABS 

Description Sets and returns the upper and lower limits for the voltage on the current absolute compassion mode.

Syntax :VOLTage:LiMiT:ABS<lower, upper> 303 ~ 303

Query Syntax :VOLTage:LiMiT:ABS?

|                                 |       |                                   |
|---------------------------------|-------|-----------------------------------|
| Parameter /<br>Return parameter | Lower | The lower limit of floating point |
|                                 | upper | The upper limit of floating point |

Example  
 ->:RES:LMT:SEQ -1.2, 1.2  
 ->:RES:LMT:SEQ?  
 ->-1.20000E+0, +1.20000E+0

Note :VOLTage:LiMiT:ABS command will switch the comparison mode for voltage to ABS mode.  
 :VOLTage:LiMiT:ABS? Command doesn't switch the comparison mode.



:VOLTage:LiMiT:PER 

Description Sets and returns the percentage of the upper and lower limits for the resistance on the current percentage compassion mode.

Syntax :VOLTage:LiMiT:PER<lower, upper> -100 ~ 100

Query Syntax :VOLTage:LiMiT:PER?

|                                 |       |                                   |
|---------------------------------|-------|-----------------------------------|
| Parameter /<br>Return parameter | Lower | The lower limit of floating point |
|                                 | upper | The upper limit of floating point |

Example  
 ->:VOLT:LMT:PER -1, 1  
 ->:VOLT:LMT:PER?  
 ->-1.00000E+0, +1.0000E+0

## AUTorange Command

:AUTorange 

**Description** Set the voltage as well as resistance range mode simultaneously. For set the range mode individually, please refer to the RES:RANG:MODE and VOLT:RANG:MODE commands

**Syntax** :AUTorange{ON/1, OFF/0}

**Query Syntax** :AUTorange?

|                         |            |                                 |
|-------------------------|------------|---------------------------------|
| <b>Parameter /</b>      | <b>ON</b>  | Enable the auto range function  |
| <b>Return parameter</b> | <b>OFF</b> | Disable the auto range function |

**Example**

```
->:AUT ON
->: AUT?
->ON
```

## ADJust Commands

|                     |     |
|---------------------|-----|
| :ADJust:CLEAr ..... | 142 |
| :ADJust.....        | 142 |

**:ADJust:CLEAr** (Set) →

|             |                                  |
|-------------|----------------------------------|
| Description | Disable the zero clear function. |
| Syntax      | :ADJust:CLEAr                    |
| Example     | ->:ADJ:CLEA                      |

**:ADJust** (Set) →  
→ (Query)

|                  |  |
|------------------|--|
| Description      | Enable the zero clear function.                                  |
| Syntax           | :ADJust  |
| Query Syntax     | :ADJust?   |
| Return parameter | 0 Zero clear is successful.                                      |
|                  | 1 Zero clear is failed.  |
| Example          | ->:ADJ<br>->:ADJ?<br>->1   |
| Note             | Before performing zero clearing, be sure to short the test clip. |

## SAMPlE Commands

|                       |     |
|-----------------------|-----|
| :SAMPlE:RATE .....    | 143 |
| :SAMPlE:AVERAge ..... | 143 |

:SAMPlE:RATE 
 →  
 →

|                                |   |                                 |
|--------------------------------|---|---------------------------------|
| Description                    | Sets or returns the sampling rate.            |                                 |
| Syntax                         | SAMPlE:RATE{SLOW, MEdium, FAST, EXFast}       |                                 |
| Query Syntax                   | SAMPlE:RATE?                                  |                                 |
| Parameter/<br>Return parameter | SLOW  | Sampling rate is slow           |
|                                | MEdium  | Sampling rate is medium         |
|                                | FAST  | Sampling rate is fast           |
|                                | EXFAST  | Sampling rate is extremely fast |
| Example                        | ->:SAMP:RATE MED<br>->:SAMP:RATE?<br>->MEdium |                                 |

:SAMPlE:AVERAge 
 →  
 →

|                                |  |                              |
|--------------------------------|--|------------------------------|
| Description                    | Sets or returns the average times.     |                              |
| Syntax                         | SAMPlE:AVERAge<integer 0~256>          |                              |
| Query Syntax                   | SAMPlE:AVERAge?                        |                              |
| Parameter/<br>Return parameter | 0,1                                    | Disable the average function |
|                                | 2~256                                  | Set average times            |
| Example                        | ->:SAMP:AVER 5<br>->:SAMP:AVER?<br>->5 |                              |

**CALCulate Commands**

|   |     |
|---|-----|
| :CALCulate:AVERAge:STATe.....                     | 144 |
| :CALCulate:AVERAge.....                           | 145 |
| :CALCulate:LIMit:STATe .....                      | 145 |
| :CALCulate:LIMit:BEEPer .....                     | 146 |
| :CALCulate:LIMit:RESistance:MODE.....             | 146 |
| :CALCulate:LIMit:RESistance:UPPer .....           | 147 |
| :CALCulate:LIMit:RESistance:LOWer .....           | 148 |
| :CALCulate:LIMit:RESistance:REFerence .....       | 148 |
| :CALCulate:LIMit:RESistance:PERCent .....         | 149 |
| :CALCulate:LIMit:VOLTagE:MODE .....               | 149 |
| :CALCulate:LIMit:VOLTagE:UPPer .....              | 150 |
| :CALCulate:LIMit:VOLTagE:LOWer .....              | 151 |
| :CALCulate:LIMit:VOLTagE:REFerence .....          | 151 |
| :CALCulate:LIMit:VOLTagE:PERCent .....            | 152 |
| :CALCulate:LIMit:ABS .....                        | 152 |
| :CALCulate:STATistics[:STATe].....                | 153 |
| :CALCulate:STATistics:RESistance:NUMBer? .....    | 153 |
| :CALCulate:STATistics:RESistance:MEAN? .....      | 154 |
| :CALCulate:STATistics:RESistance:MAXimum? .....   | 154 |
| :CALCulate:STATistics:RESistance:MINimum? .....   | 154 |
| :CALCulate:STATistics:RESistance:LiMit? .....     | 155 |
| :CALCulate:STATistics:RESistance:DEViation? ..... | 155 |
| :CALCulate:STATistics:RESistance:CP? .....        | 156 |
| :CALCulate:STATistics:VOLTagE:NUMBer? .....       | 156 |
| :CALCulate:STATistics:VOLTagE:MEAN?.....          | 156 |
| :CALCulate:STATistics:VOLTagE:MAXimum?.....       | 157 |
| :CALCulate:STATistics:VOLTagE:MINimum?.....       | 157 |
| :CALCulate:STATistics:VOLTagE:LiMit? .....        | 157 |
| :CALCulate:STATistics:VOLTagE:DEViation? .....    | 158 |
| :CALCulate:STATistics:VOLTagE:CP?.....            | 158 |

:CALCulate:AVERAge:STATe 

|              |   |
|--------------|---|
| Description  | Disable the average function. Set the average count to 1. |
| Syntax       | :CALCulate:AVERAge:STATe{OFF}                             |
| Query Syntax | :CALCulate:AVERAge:STATe?                                 |



|                  |   |  |
|------------------|---|--|
| Parameter        | OFF   | Set the average count of device to one.    |
| Return parameter | OFF   | Average count of device is one.            |
|                  | ON  | Average count of device is more than once. |
| Example          | ->:CALC:AVER:STAT OFF<br>->:CALC:AVER:STAT?<br>->OFF  |  |
| Note             | It is recommended using SAMPLE:AVERage 0 command to substitute.<br><br>This command doesn't have enable function. Which means that CALC:AVER:STAT ON command is invalid. To enable average function, use SAMP:AVER <2 ~ 256> command instead. |  |

**:CALCulate:AVERage** 

  

|                              |  |                              |
|------------------------------|--|------------------------------|
| Description                  | Sets and returns count of average function.                |                              |
| Syntax                       | :CALCulate:AVERage <0 ~256>                                |                              |
| Query Syntax                 | :CALCulate:AVERage?  |                              |
| Parameter / Return parameter | 0, 1   | Disable the average function |
|                              | 2~256  | Set average frequency        |
| Example                      | ->: CALCulate:AVERage 10<br>->: CALCulate:AVERage?<br>->10 |                              |

**:CALCulate:LIMit:STATe** 

|                              |  |   |
|------------------------------|--|---|
| Description                  | Sets and returns the state of comparator for voltage and resistance. |   |
| Syntax                       | :CALCulate:LIMit:STATe{OFF/0, ON/1}                                  |   |
| Query Syntax                 | :CALCulate:LIMit:STATe?  |   |
| Parameter / Return parameter | ON   | Enable both the comparators for voltage and for resistance. |

|     |  |
|-----|--|
| OFF | Disable both the comparators for voltage and for resistance. |
|-----|--|

Example

```
->:CALC:LIM:STAT OFF
->:CALC:LIM:STAT?
->OFF
```

Note

:CALCulate:LiMit:STATe command enables or disables the comparators for voltage and for resistance simultaneously.

If a single comparator for resistance or voltage needs to be used, use the :RES:LMT:STATe and :VOLT:LMT:STATe commands.

Set →  
 → Query

**:CALCulate:LIMit:BEEPer**

|                  |  |                                      |
|------------------|--|--------------------------------------|
| Description      | Sets the comparator buzzer.                                    |                                      |
| Syntax           | :CALCulate:LIMit:BEEPer{0/OFF, HL/NG/FAIL, IN/OK/PASS}         |                                      |
| Query Syntax     | :CALCulate:LIMit:PEEPer?                                       |                                      |
| Return parameter | OFF  | Disable the comparator buzzer.       |
|                  | HL   | Buzzer sounds when testing is failed |
|                  | IN   | Buzzer sounds when testing is passed |
| Example          | <pre>-&gt;:CALC:LIM:BEEP HL -&gt;:CALC:LIM:BEEP? -&gt;HL</pre> |                                      |

Set →  
 → Query

**:CALCulate:LIMit:RESistance:MODE**

|                              |  |   |
|------------------------------|--|---|
| Description                  | Sets and returns the comparator mode for resistance. |   |
| Syntax                       | :CALCulate:LIMit:RESistance:MODE{HL, REF, ABS}       |   |
| Query Syntax                 | :CALCulate:LIMit:RESistance:MODE?                    |   |
| Parameter / Return parameter | HL   | Upper and lower limits of direct readout comparison (SEQ) |

|         |  |  |
|---------|--|--|
|         | REF  | Percentage comparison (% relative deviation) (PER) |
|         | ABS  | Absolute deviation comparison ( $\Delta$ )         |
| Example | ->:CALC:LIM:RES:MODE HL<br>->:CALC:LIM:RES:MODE?<br>->HL |  |

Set  $\rightarrow$   
 $\rightarrow$  Query

**:CALCulate:LIMit:RESistance:UPPer**

|                              |  |  |
|------------------------------|--|--|
| Description                  | Sets and returns upper limits for resistance comparator.     |  |
| Syntax                       | :CALCulate:LIMit:RESistance:UPPer<0 ~ 99999>                 |  |
| Query Syntax                 | :CALCulate:LIMit:RESistance:UPPer?                           |  |
| Parameter / Return parameter | 0~99999  | Positive integer. If the parameter is more than 99999, the parameter will be set to 99999 automatically. |
| Example                      | ->:CALC:LIM:RES:UPP 12345<br>->:CALC:LIM:RES:UPP?<br>->12345 |  |

**Note** The number of decimal digits and unit are related to the current range no. Please refer to the following table for their relationship.

| Range no.         | Number of decimal digits | Unit       | Description                |
|-------------------|--------------------------|------------|----------------------------|
| 0(3m $\Omega$ )   | 4                        | m $\Omega$ | 12345=1.2345 m $\Omega$    |
| 1(30m $\Omega$ )  | 3                        | m $\Omega$ | 12345=12.345 m $\Omega$    |
| 2(300m $\Omega$ ) | 2                        | m $\Omega$ | 12345=123.45 m $\Omega$    |
| 3(3 $\Omega$ )    | 4                        | $\Omega$   | 12345=1.2345 $\Omega$      |
| 4(30 $\Omega$ )   | 3                        | $\Omega$   | 12345=12.345 $\Omega$      |
| 5(300 $\Omega$ )  | 2                        | $\Omega$   | 12345=123.45 $\Omega$      |
| 6(3k $\Omega$ )   | 4                        | $\Omega$   | 12345=1.2345 (k $\Omega$ ) |

:CALCulate:LIMit:RESistance:LOWer (Set) →  
→ (Query)

|                              |  |  |
|------------------------------|--|--|
| Description                  | Sets and returns lower limits for resistance comparator.   |  |
| Syntax                       | :CALCulate:LIMit:RESistance:LOWer<0 ~ 99999>               |  |
| Query Syntax                 | :CALCulate:LIMit:RESistance:LOWer?                         |  |
| Parameter / Return parameter | 0~99999  | Positive integer. If the parameter is more than 99999, the parameter will be set to 99999 automatically. |
| Example                      | ->:CALC:LIM:RES:LOW 1000<br>->:CALC:LIM:RES:LOW?<br>->1000 |  |

Note The number of decimal digits and unit are related to the current range no. Please refer to the following table for their relationship.

| Range no. | Number of decimal digits | Unit | Description     |
|-----------|--------------------------|------|-----------------|
| 0(3mΩ)    | 4                        | mΩ   | 1000=0.1000 mΩ  |
| 1(30mΩ)   | 3                        | mΩ   | 1000=1.000 mΩ   |
| 2(300mΩ)  | 2                        | mΩ   | 1000=10.00 mΩ   |
| 3(3Ω)     | 4                        | Ω    | 1000=0.1000 Ω   |
| 4(30Ω)    | 3                        | Ω    | 1000=1.000 Ω    |
| 5(300Ω)   | 2                        | Ω    | 1000=10.00 Ω    |
| 6(3kΩ)    | 4                        | Ω    | 1000=0.1000(kΩ) |

:CALCulate:LIMit:RESistance:REFerence (Set) →  
→ (Query)

|              |   |  |
|--------------|---|--|
| Description  | Sets and returns nominal value for resistance comparator. |  |
| Syntax       | :CALCulate:LIMit:RESistance:REFerence<0 ~ 99999>          |  |
| Query Syntax | :CALCulate:LIMit:RESistance:REFerence?                    |  |

|                              |         |  |
|------------------------------|---------|--|
| Parameter / Return parameter | 0~99999 | Positive integer. If the parameter is more than 99999, the parameter will be set to 99999 automatically. |
|------------------------------|---------|--|

Example  
 ->:CALC:LIM:RES:REF 10000  
 ->:CALC:LIM:RES:REF?  
 ->10000

| Range no. | Number of decimal digits | Unit | Description     |
|-----------|--------------------------|------|-----------------|
| 0(3mΩ)    | 4                        | mΩ   | 10000=1.0000 mΩ |
| 1(30mΩ)   | 3                        | mΩ   | 10000=10.000 mΩ |
| 2(300mΩ)  | 2                        | mΩ   | 10000=100.00 mΩ |
| 3(3Ω)     | 4                        | Ω    | 10000=1.0000 Ω  |
| 4(30Ω)    | 3                        | Ω    | 10000=10.000 Ω  |
| 5(300Ω)   | 2                        | Ω    | 10000=100.00 Ω  |
| 6(3kΩ)    | 4                        | Ω    | 10000=1.0000 Ω  |

→  
 →

---

**:CALCulate:LIMit:RESistance:PERCent**

**Description** Sets and returns limit in percentage for resistance comparator.

**Syntax** :CALCulate:LIMit:RESistance:PERCent<float> (0.0 ~ 100.0)

**Query Syntax** :CALCulate:LIMit:RESistance:PERCent?

|                              |                 |  |
|------------------------------|-----------------|--|
| Parameter / Return parameter | (0.00 ~ 100.00) | It is a floating-point number and without positive and negative symbols. |
|------------------------------|-----------------|--|

Example  
 ->:CALC:LIM:RES:PERC 1.100  
 ->:CALC:LIM:RES:PERC?  
 ->1.100

**Note**

→  
 →

---

**:CALCulate:LIMit:VOLTage:MODE**

**Description** Sets and returns the comparator mode for voltage.

**Syntax** :CALCulate:LIMit:VOLTage:MODE{HL/REF/ABS}

|              |  |  |
|--------------|--|--|
| Query Syntax | :CALCulate:LIMit:VOLTage:MODE?                             |  |
|              | HL   | Upper and lower limits of direct readout comparison. (SEQ) |
|              | REF  | Percentage comparison. (% relative deviation) (PER)        |
|              | ABS  | Absolute deviation comparison ( $\Delta$ )                 |
| Example      | ->:CALC:LIM:VOLT:MODE HL<br>->:CALC:LIM:VOLT:MODE?<br>->HL |  |

Note

:CALCulate:LIMit:VOLTage:UPPer  

|                              |  |  |
|------------------------------|--|--|
| Description                  | Sets and returns upper limit for voltage comparator.             |  |
| Syntax                       | :CALCulate:LIMit:VOLTage:UPPer<0 ~ 999999>                       |  |
| Query Syntax                 | :CALCulate:LIMit:VOLTage:UPPer?                                  |  |
| Parameter / Return parameter | 0~999999   | Positive integer. If the parameter is more than 999999, the parameter will be set to 999999 automatically. |
| Example                      | ->:CALC:LIM:VOLT:UPP 123456<br>->:CALC:LIM:VOLT:UPP?<br>->123456 |  |

Note The number of decimal digits and unit are related to the current range no. Please refer to the following table for their relationship.

| Range no. | Number of decimal digits | Unit | Description     |
|-----------|--------------------------|------|-----------------|
| 0(8V)     | 5                        | V    | 123456=1.23456V |
| 1(80V)    | 4                        | V    | 123456=12.3456V |
| 2(300V)   | 3                        | V    | 123456=123.456V |

Set →

→ Query

**:CALCulate:LIMit:VOLTage:LOWer**

|                              |  |  |
|------------------------------|--|--|
| Description                  | Sets and returns lower limit for voltage comparator.             |  |
| Syntax                       | :CALCulate:LIMit:VOLTage:LOWer<0 ~999999>                        |  |
| Query Syntax                 | :CALCulate:LIMit:VOLTage:LOWer?                                  |  |
| Parameter / Return parameter | 0~999999   | Positive integer. If the parameter is more than 999999, the parameter will be set to 999999 automatically. |
| Example                      | ->:CALC:LIM:VOLT:LOW 100000<br>->:CALC:LIM:VOLT:LOW?<br>->100000 |  |

Note The number of decimal digits and unit are related to the current range no. Please refer to the following table for their relationship.

| Range no. | Number of decimal digits | Unit | Description     |
|-----------|--------------------------|------|-----------------|
| 0(8V)     | 5                        | V    | 100000=1.00000V |
| 1(80V)    | 4                        | V    | 100000=10.0000V |
| 2(300V)   | 3                        | V    | 100000=100.000V |

Set →

→ Query

**:CALCulate:LIMit:VOLTage:REFerence**

|                              |  |  |
|------------------------------|--|--|
| Description                  | Sets and returns nominal value for voltage comparator.           |  |
| Syntax                       | :CALCulate:LIMit:VOLTage:REFerence<0 ~ 999999>                   |  |
| Query Syntax                 | :CALCulate:LIMit:VOLTage:REFerence?                              |  |
| Parameter / Return parameter | 0~999999   | Positive integer. If the parameter is more than 999999, the parameter will be set to 999999 automatically. |
| Example                      | ->:CALC:LIM:VOLT:REF 100000<br>->:CALC:LIM:VOLT:REF?<br>->100000 |  |

Note The number of decimal digits and unit are related to the current range no. Please refer to the following table for their relationship.

| Range no. | Number of decimal digits | Unit | Description     |
|-----------|--------------------------|------|-----------------|
| 0(8V)     | 5                        | V    | 100000=1.00000V |
| 1(80V)    | 4                        | V    | 100000=10.0000V |
| 2(300V)   | 3                        | V    | 100000=100.000V |

Set →

**:CALCulate:LIMit:VOLTage:PERCent**

→ Query

Description Sets and returns limit in percentage for voltage comparator.

Syntax :CALCulate:LIMit:VOLTage:PERCent<float> (0.0 ~ 100.0)

Query Syntax :CALCulate:LIMit:VOLTage:PERCent?

Parameter / Return parameter (0.0 ~ 100.0) It is a floating-point number without positive and negative symbols.

Example  
 ->:CALC:LIM:VOLT:PERC 1.1  
 ->:CALC:LIM:VOLT:PERC?  
 ->1.100

Note

Set →

**:CALCulate:LIMit:ABS**

→ Query

Description Sets absolute deviation comparison for voltage.

Syntax :CALCulate:LIMit:ABS {ON/1, OFF/0}

Query Syntax :CALCulate:LIMit:ABS?

|                              |     |  |
|------------------------------|-----|--|
| Parameter / Return parameter | ON  | Sets the comparator for voltage to absolute deviation comparison.              |
|                              | OFF | Sets the comparator for voltage to relative deviation (percentage) comparison. |

Example  
 ->:CALC:LIM:ABS ON  
 ->:CALC:LIM:ABS?  
 ->ON



Note This command has the same function as VOLT:LMT:MODE ABS. This command is valid only for voltage.

Set →  
 → Query

**:CALCulate:STATistics[:STATe]**

|                                 |  |                                  |
|---------------------------------|--|----------------------------------|
| Description                     | Sets or returns the status of processing data. |                                  |
| Syntax                          | :CALCulate:STATistics[:STATe]{LOG, STAT}       |                                  |
| Query Syntax                    | :CALCulate:STATistics[:STATe]?                 |                                  |
| Parameter /<br>Return parameter | LOG  | Enable the data logging function |
|                                 | STAT   | Enable the statistics function   |
| Example                         | ->:CALC:STAT LOG<br>->:CALC:STAT?<br>->LOG     |                                  |

Note Please use command “LOG:START ON” to enable data logging and statistic function when trigger mode is set to INT.  
  
Please use trigger key to enable data logging and statistic function when trigger mode is set to EXT.

**:CALCulate:STATistics:RESistance:NUMBER?** → Query

|                  |   |                            |
|------------------|---|----------------------------|
| Description:     | Queries the numbers of statistics for resistance.   |                            |
| Query Syntax     | :CALCulate:STATistics:RESistance:NUMBER?  |                            |
| Return parameter | <Total No.>,<Effective No.>   | Both numbers are integers. |
| Example          | ->:CALC:STAT:RES:NUMB?<br>->10, 8   |                            |
| Note             | Effective quantity doesn't include the number of overflow (OF) or error (FAULT). The value is regarded as valid as long as it can be displayed on the screen. |                            |

**:CALCulate:STATistics:RESistance:MEAN? → Query**

**Description:** Queries the average value of the statistics for resistance.

**Query Syntax** :CALCulate:STATistics:RESistance:MEAN?

**Return parameter** < floating-point>

**Example** ->:CALC:STAT:RES:MEAN?  
->+1.2568E-3

**Note** Average value is  $\bar{x} = \frac{\sum x}{n}$

**:CALCulate:STATistics:RESistance:MAXimum? → Query**

**Description:** Queries the maximum of the statistics for resistance.

**Query Syntax** :CALCulate:STATistics:RESistance:MAXimum?

**Return parameter** <floating-point>, <the N-th data> N means that the N-th data is the maximum value from the measured data.

**Example** ->:CALC:STAT:RES:MAX?  
->+354.76E+0,2

**Note**

**:CALCulate:STATistics:RESistance:MINimum? → Query**

**Description:** Queries the minimum of the statistics for resistance.

**Query Syntax** :CALCulate:STATistics:RESistance:MINimum?

**Return parameter** <floating-point>, <the N-th data> N means that the N-th data is the minimum value from the measured data.

Example ->:CALC:STAT:RES:MIN?  
->+354.33E+0,7

### :CALCulate:STATistics:RESistance:LiMit? → Query

Description: Queries the result count of statistics for resistance.

Query Syntax :CALCulate:STATistics:RESistance:LiMit?

Return parameter <HI count>, <OK count>, <LO count>, <FAULT count>

Example ->:CALC:STAT:RES:LIM?  
->0, 10, 0, 0

Note When querying the file count of comparator, make sure the comparator function is enabled, otherwise 0, 0, 0, 0 will be returned for data.

### :CALCulate:STATistics:RESistance:DEVIation? → Query

Description: Queries the standard deviation value of statistics for resistance.

Query Syntax :CALCulate:STATistics:RESistance:DEVIation?

Return parameter < Standard deviation of maternal  $\sigma_n$ >,  
<Standard deviation of samples  $\sigma_{n-1}$  >

Example ->:CALC:STAT:RES:DEV?  
->0.0016, 0.0017

Note Standard deviation of maternal:  $\sigma_n = \sqrt{\frac{\sum(x-\bar{x})^2}{n}} = \sqrt{\frac{\sum x^2 - n\bar{x}^2}{n}}$

Standard deviation of samples:  $\sigma_{n-1} = \sqrt{\frac{\sum(x-\bar{x})^2}{n-1}} = \sqrt{\frac{\sum x^2 - n\bar{x}^2}{n-1}}$

**:CALCulate:STATistics:RESistance:CP?** → **Query**

**Description:** Queries process capability index of statistics for resistance.

**Query Syntax** :CALCulate:STATistics:RESistance:CP?

**Return parameter** <Cp (deviation) >, <Cpk(offset)>

**Example** ->:CALC:STAT:RES:CP?  
->99.85, 75.56

**Note** Process capability index (deviation)  $Cp = \frac{|Hi-Lo|}{6\sigma_{n-1}}$   
Process capability index (offset)  
 $CpK = \frac{|Hi-Lo|-|Hi+Lo-2\bar{x}|}{6\sigma_{n-1}}$

**:CALCulate:STATistics:VOLTage:NUMBer?** → **Query**

**Description:** Queries the number of statistics for voltage.

**Query Syntax** :CALCulate:STATistics:VOLTage:NUMBer?

**Return parameter** <Total No.>,<Effective No.> Both numbers are integers.

**Example** ->:CALC:STAT:VOLT:NUMB?  
->10, 10

**Note** Effective quantity doesn't include the number of overflow (OF) or error (FAULT). The value is regarded as valid as long as it can be displayed on the screen.

**:CALCulate:STATistics:VOLTage:MEAN?** → **Query**

**Description:** Queries the average value of the statistics for voltage.

**Query Syntax** :CALCulate:STATistics:VOLTage:NEAN?

**Return parameter** < floating-point>

Example           ->:CALC:STAT:VOLT:MEAN?  
                   ->+3.70601E+0

Note              Average value  $\bar{x} = \frac{\sum x}{n}$

**:CALCulate:STATistics:VOLTage:MAXimum?**   → **Query**

Description:      Queries the maximum of the statistics for voltage.

Query Syntax     :CALCulate:STATistics:VOLTage:MAXimum?

Return parameter <floating-point>,  
                   <the N-th data>    N means that the N-th data is the  
   maximum value from the  
   measured data.

Example           ->:CALC:STAT:VOLT:MAX?  
                   ->+3.70890E0, 4

Note

**:CALCulate:STATistics:VOLTage:MINimum?**   → **Query**

Description:      Queries the minimum of the statistics for voltage.

Query Syntax     :CALCulate:STATistics:VOLTage:MINimum?

Return parameter <floating-point>,  
                   <the N-th data>    N means that the N-th data is the  
   minimum value from the  
   measured data.

Example           ->:CALC:STAT:VOLT:MIN?  
                   ->+3.70566E0, 5

**:CALCulate:STATistics:VOLTage:LiMit?**       → **Query**

Description:      Queries the result count of statistics for voltage.

Query Syntax     :CALCulate:STATistics:VOLTage:LiMit?

Return parameter <HI count>, <OK count>, <LO count>, <FAULT  
                   count>

Example ->:CALC:STAT:VOLT:LIM?  
->0, 10, 0, 0

Note When querying the file count of comparator, make sure the comparator function is enabled, otherwise 0, 0, 0 will be returned for data.

**:CALCulate:STATistics:VOLTage:DEVIation? → (Query)**

Description: Queries the standard deviation value of statistics for voltage.

Query Syntax :CALCulate:STATistics:VOLTage:DEVIation?

Return parameter < Standard deviation of maternal  $\sigma_n$  >,  
<Standard deviation of samples  $\sigma_{n-1}$  >

Example ->:CALC:STAT:VOLT:DEV?  
->0.0002, 0.0002

Note Standard deviation of maternal:  $\sigma_n = \sqrt{\frac{\sum(x-\bar{x})^2}{n}} = \sqrt{\frac{\sum x^2 - n\bar{x}^2}{n}}$

Standard deviation of samples:  $\sigma_{n-1} = \sqrt{\frac{\sum(x-\bar{x})^2}{n-1}} = \sqrt{\frac{\sum x^2 - n\bar{x}^2}{n-1}}$

**:CALCulate:STATistics:VOLTage:CP? → (Query)**

Description: Queries process capability index of statistics for voltage.

Query Syntax :CALCulate:STATistics:VOLTage:CP?

Return parameter <Cp (deviation) >, <Cpk(offset)>

Example ->:CALC:STAT:VOLT:CP?  
->72.110, 8.6692

|      |   |
|------|---|
| Note | Process capability index (deviation) $Cp = \frac{ Hi-Lo }{6\sigma_{n-1}}$                   |
|      | Process capability index (offset)<br>$CpK = \frac{ Hi-Lo - Hi+Lo-2\bar{x} }{6\sigma_{n-1}}$ |

---

## LOGger (MEMory) Commands

|                       |     |
|-----------------------|-----|
| :LOGger[:STATe] ..... | 160 |
| :LOGger:START .....   | 160 |
| :LOGger:SIZE .....    | 161 |
| :LOGger:COUNt .....   | 161 |
| :LOGger:DATA? .....   | 161 |

:LOGger[:STATe] 

|                              |  |                                   |
|------------------------------|--|-----------------------------------|
| Description                  | Sets or returns the status of processing data. |                                   |
| Syntax                       | :LOGger[:STATe]{LOG, STAT}                     |                                   |
| Query Syntax                 | :LOGger[:STATe]?                               |                                   |
| Parameter / Return parameter | LOG  | Enable the data logging function. |
|                              | STAT   | Enable the statistics function.   |
| Example                      | ->:LOG:STAT LOG<br>->:LOG?<br>->LOG            |                                   |

:LOGger:START 

|                              |  |                    |
|------------------------------|--|--------------------|
| Description                  | Stop or start the process of data logging. |                    |
| Syntax                       | :LOGger:START{ON(1), OFF(0)}               |                    |
| Query Syntax                 | :LOGger:START?                             |                    |
| Parameter / Return parameter | 0  | Stop data logging  |
|                              | 1  | Start data logging |
| Example                      | ->:LOG:START ON<br>->:LOG:START?<br>->ON   |                    |



This command is valid only when Data logging function is enabled. Confirm the status of [DATA logging] on [SYSTEM CONFIG]Page.

If the current page is not on [MEAS DISPLAY] page, this command will automatically switch [MEAS DISPLAY] page.

|                              |   | Set →   |
|------------------------------|---|---|
|                              |   | → Query   |
| <b>:LOGger:SIZE</b>          |   |   |
| Description                  | Sets or returns buffer size for data recording. |   |
| Syntax                       | :LOGger:SIZE{<1~10000>, max}                    |   |
| Query Syntax                 | :LOGger:SIZE?                                   |   |
| Parameter / Return parameter | <1~10000>                                       | Integer. If the number is less than 1, it will be set to 1 automatically. |
|                              | Max   | Set the buffer to 10000   |
| Example                      | ->:LOG:SIZE 100<br>->:LOG:SIZE?<br>->100        |   |

|                              |   | → Query  |
|------------------------------|---|--|
| <b>:LOGger:COUNT</b>         |   |  |
| Description                  | Queries the total number of recorded data in buffer |  |
| Query Syntax                 | :LOGger:COUNT?                                      |  |
| Parameter / Return parameter | 0~10000   | If return value is zero, it means buffer is empty. |
| Example                      | ->:LOG:COUNT?<br>->10                               |  |

|                      |                                     | → Query |
|----------------------|-------------------------------------|---------|
| <b>:LOGger:DATA?</b> |                                     |         |
| Description          | Queries the value of data in buffer |         |
| Query Syntax         | :LOGger:DATA?                       |         |

|                  |  |  |
|------------------|--|--|
| Parameter        | 0~10000  | Integer.   |
| Return Parameter | <Total count> ; <Index num> <RES>,<VOLT>;  | If the specified index is greater than the total number of data or the specified index less than 1, return 0 |
| Example          | -> :LOG:DATA?<br>-> 3;<br>1,+12.345E+0,+8.7654E+0;<br>2,+12.345E+0,+8.7654E+0;<br>3,+12.345E+0,+8.7654E+0; |  |

## SYSTEM Commands

|                                |     |
|--------------------------------|-----|
| :SYSTem:TIME.....              | 163 |
| :SYSTem:KEYLock .....          | 163 |
| :SYSTem:CODE.....              | 164 |
| :SYSTem:BEEPer .....           | 164 |
| :SYSTem:CURRent .....          | 165 |
| :SYSTem:CALibration .....      | 165 |
| :SYSTem:CALibration:AUTO ..... | 166 |
| :SYSTem:RESult .....           | 166 |
| :SYSTem:DATAout .....          | 166 |
| :SYSTem:BACKup .....           | 167 |

### :SYSTem:TIME

Set →

→ Query

|               |  |
|---------------|--|
| Description   | Sets or returns and return system time.                                    |
| Syntax        | :SYSTem:TIME <YEAR>-<MONTH>-<DAY><br><HOUR>:<MINUTE>:<SECOND>              |
| Return syntax | :SYSTem:TIME?  |
| Example       | ->:SYST:TIME 2016,12,30,11,18,31<br>->:SYST:TIME?<br>->2016-12-30 11:18:31 |

### :SYSTem:KEYLock

Set →

→ Query

|                  |  |
|------------------|--|
| Description      | Sets or returns the state of the key protection. |
| Syntax           | :SYSTem:KEYLock {OFF/0, ON/1}                    |
| Query Syntax     | :SYSTem:KEYLock?                                 |
| Parameter/Return | 0 Turn the key protection function off           |
| Parameter        | 1 Turn the key protection function on            |
| Example          | ->:SYSTEM:KEYL OFF<br>->:SYSTEM:KEYL?<br>->OFF   |

Set →

→ Query

**:SYSTem:CODE**

|                  |   |                                   |
|------------------|---|-----------------------------------|
| Description      | Sets or returns the state of the error code function. |                                   |
| Syntax           | :SYSTem:CODE {OFF/0, ON/1}                            |                                   |
| Query Syntax     | :SYSTem:CODE?   |                                   |
| Parameter/       | 0   | Turn the error code function off. |
| Return parameter | 1   | Turn the error code function on.  |
| Example          | ->:SYST:CODE ON<br>->:SYST:CODE?<br>->ON              |                                   |

**Note**

- If command “:SYST:CODE” is enabled, the instrument will return an error code each time it receives an instruction. If command “:SYST:CODE” is disabled, user can obtain error code through command “ERR?”

- E00: No error.
- E01: Bad command.
- E02: Parameter error.
- E03: Missing parameter.
- E04: Buffer overruns.
- E05: Syntax error.
- E06: Invalid separator.
- E07: Invalid multiplier.
- E08: Numeric data error.
- E09: Value too long
- E10: Invalid command
- E11: Unknown error

Set →

→ Query

**:SYSTem:BEEPer**

|              |   |  |
|--------------|---|--|
| Description  | Sets or returns the key click beeper state. |  |
| Syntax       | :SYSTem:BEEPer {OFF/0, ON/1}                |  |
| Query Syntax | :SYSTem:BEEPer?                             |  |

|                                |  |   |
|--------------------------------|--|---|
| Parameter/<br>Return parameter | 0  | Turn the key click beeper function off. |
|                                | 1  | Turn the key click beeper function on.  |
| Example                        | ->:SYST:BEEP OFF<br>->:SYST:BEEP?<br>->OFF |   |

### :SYSTem:CURRent

Set →

→ Query

|                                |   |  |
|--------------------------------|---|--|
| Description                    | Sets or returns the current output mode.            |  |
| Syntax                         | :SYSTem:CURRent {CONTInous, PULSe}                  |  |
| Query Syntax                   | :SYSTem:CURRent?                                    |  |
| Parameter/<br>Return parameter | CONTINUOUS  | Current is output continuously.            |
|                                | PULSE   | Current is only output during measurement. |
| Example                        | ->:SYST:CURR PULS<br>->:SYST:CURR?<br>-> CONTINUOUS |  |

### :SYSTem:CALibration

Set →

|             |   |  |
|-------------|---|--|
| Description | Sets the self-calibration once.   |  |
| Syntax      | :SYSTem:CALibration   |  |
| Example     | ->:SYST:CAL   |  |
| Note        | A self-calibration takes about 40ms. If the command is sent out , it will be delayed by at least 40ms before the next command can be processed. |  |

Set →  
 → Query

**:SYSTem:CALibration:AUTO**

---

|                            |  |   |
|----------------------------|--|---|
| Description                | Sets or returns the status of self-calibration function. |   |
| Syntax                     | :SYSTem:CALibration:AUTO {OFF/0, ON/1}                   |   |
| Query Syntax               | :SYSTem:CALibration:AUTO?                                |   |
| Parameter/Return parameter | 0  | Disable the self-calibration function of device.  |
|                            | 1  | Enable the self-calibration function of device. The device will self-calibrate once per 30 minutes. |
| Example                    | ->:SYST:CAL:AUTO OFF<br>->:SYST:CAL:AUTO?<br>->OFF       |   |

Set →  
 → Query

**:SYSTem:RESult**

---

|                            |  |   |
|----------------------------|--|---|
| Description                | Sets or returns the means for sending data. Automatic or by using FETCH instruction. |   |
| Syntax                     | :SYSTem:RESult {FETCH, AUTO}   |   |
| Query Syntax               | :SYSTem:RESult?  |   |
| Parameter/Return parameter | FETCH  | The data can only be returned to the master through Fetch instruction. The device passively sends the data. |
|                            | AUTO   | The test results are automatically sent to the master after each test is completed.                         |
| Example                    | ->:SYST:RES AUTO<br>->:SYST:RES?<br>->AUTO   |   |

Set →  
 → Query

**:SYSTem:DATAout**

---

|             |   |  |
|-------------|---|--|
| Description | Sets or returns the means for sending data. |  |
|-------------|---|--|

|                            |  |   |  |   |   |
|----------------------------|--|---|--|---|---|
| Syntax                     | :SYSTem:DATAout {OFF/0, ON/1}  |   |  |   |   |
| Query Syntax               | :SYSTem:DATAout?   |   |  |   |   |
| Parameter/Return parameter | <table border="1"> <tr> <td>0</td> <td>The data can only be returned to the mater through Fetch instruction fetch. The device passively sends the data.</td> </tr> <tr> <td>1</td> <td>The test results are automatically sent to the master after each test is completed.</td> </tr> </table> | 0 | The data can only be returned to the mater through Fetch instruction fetch. The device passively sends the data. | 1 | The test results are automatically sent to the master after each test is completed. |
| 0                          | The data can only be returned to the mater through Fetch instruction fetch. The device passively sends the data.   |   |  |   |   |
| 1                          | The test results are automatically sent to the master after each test is completed.  |   |  |   |   |
| Example                    | <pre>-&gt;:SYST:DATA ON -&gt;:SYST:DATA? -&gt;ON</pre>   |   |  |   |   |
| Note                       | Both commands “:SYSTem:RESult” and “:SYSTem:DATAout” can set the means for sending data. Either by automatic or by using FETCH command. The only different are parameter and return parameter.   |   |  |   |   |

**:SYSTem:BACKup**

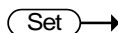

|             |   |
|-------------|---|
| Description | Sets to save measurement parameter to current file. |
| Syntax      | :SYSTem:BACKup                                      |
| Example     | ->:SYST:BACKup                                      |

## TRIGger Commands

|                           |     |
|---------------------------|-----|
| :TRIGger:SOURce.....      | 168 |
| :TRIGger:DElay .....      | 168 |
| :TRIGger:DElay:STATe..... | 169 |
| :TRG.....                 | 169 |

### :TRIGger:SOURce

Set →

→ Query

|                            |  |                                |
|----------------------------|--|--------------------------------|
| Description                | Sets or returns the trigger source.              |                                |
| Syntax                     | :TRIGger:SOURce {IMMEdiate, EXTErnal}            |                                |
| Query Syntax               | :TRIGger:SOURce ?                                |                                |
| Parameter Return parameter | IMMEDIATE  | Set trigger source as INT mode |
|                            | EXTERNAL   | Set trigger source as EXT mode |
| Example                    | ->:TRIG:SOUR EXT<br>->:TRIG:SOUR?<br>->:EXTERNAL |                                |

### :TRIGger:DElay



Set →

→ Query

|                            |   |                 |
|----------------------------|---|-----------------|
| Description                | Sets or returns the trigger delay timer.  |                 |
| Syntax                     | :TRIGger:DElay<0.001~10.000>  |                 |
| Query Syntax               | :TRIGger:DElay?   |                 |
| Parameter/Return parameter | <0.001~10.000>  | Unit is second. |
| Example                    | ->:TRIG:DEL 0.001<br>->:TRIG:DEL?<br>->0.001                                    |                 |
| Note                       | If the trigger delay function is not enabled, the command will enable it first. |                 |

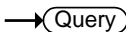

|                                |   |   |
|--------------------------------|---|---|
|                                |   |  |
|                                |   |  |
| <b>:TRIGger:DELay:STATe</b>    |   |   |
| Description                    | Sets or returns the status of trigger delay function. |   |
| Syntax                         | :TRIGger:DELay:STATe {OFF/0, ON/1}                    |   |
| Query Syntax                   | :TRIGger:DELay:STATe?                                 |   |
| Parameter/<br>Return parameter | 0   | Enable the trigger delay function.  |
|                                | 1   | Disable the trigger delay function.   |
| Example                        | ->:TRIG:DEL:STAT OFF<br>->:TRIG:DEL:STAT?<br>->OFF    |   |

|             |   |   |
|-------------|---|---|
|             |   |  |
|             |   |  |
| <b>:TRG</b> |   |   |
| Description | A trigger is generated when the trigger source is set to EXT mode, and data is returned after triggering. |   |
| Syntax      | :TRG  |   |
| Example     | ->:TRG  |   |

### FETCh (READ) commands

FETCh and READ commands are similar. FETCh command is used to return the last measurement data, and READ command is used to return the latest measurement data. Therefore, data is returned after a complete measurement cycle through READ commands and the implementation efficiency is slightly worse at slow measurement.

FETCh commands are used to obtain test data. Before using this command, you need to set the [Result] option to FETCH on the [SYSTEM CONFIG] page.

```
:FETCh? .....
:FETCh:FULL .....
```

### :FETCh?



|              |   |
|--------------|---|
| Description  | Returns the main test data.   |
| Query Syntax | :FETCh?   |
| Parameter    | <R>,<V> Return both the resistance and voltage value  |
|              | <R> Return the resistance value   |
|              | <V> Return the resistance value   |
| Example      | ->:FETC?<br>->22.005E+0, 3.69943E+0   |
| Note         | If current LCD screen is not displayed on [MEAS DISPLAY] or [ENLARGE DISPLAY] page, the LCD screen will be switched to [MEAS DISPLAY] page before returning the measurement data when using this command. |

:FETCh:FULL

→ Query

|              |   |
|--------------|---|
| Description  | Returns the fully test data including measurement data, comparator results and monitoring data.   |
| Query Syntax | :FETCh:FULL?  |
| Parameter    | <Floating point> First returned parameter is resistance value   |
|              | <Floating point> Second returned parameter is voltage value.  |
|              | <HI/OK/LO> Result for resistance  |
|              | <HI/OK/LO> Result for voltage   |
|              | <PASS/FAIL /WIRE/OPEN> Display total result   |
|              | Monitor type and value  |
| Example      | ->:FETCh:FULL?<br>->□□21.993e+0, □3.70088e+0, OK, HI, FAIL, RPER:+2.18930e+04   |
| Note         | If the current page is not on [MEAS DISPLAY] or [ENLARGE DISPLAY] page when using this command, the LCD screen will be switched to [MEAS DISPLAY] page before returns the measurement data. |

## CORRection command

:CORRection:SHORt

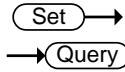

## FILE (MMEM) commands

|                    |     |
|--------------------|-----|
| :FILE:SAVE .....   | 173 |
| :FILE:LOAD .....   | 173 |
| :FILE:DELeTe ..... | 173 |

### :FILE:SAVE



**Description** To save current settings to the current file or specified file.

**Syntax** :FILE:SAVE {None| <File No. 0~9>}

|                  |                |                |
|------------------|----------------|----------------|
| <b>Parameter</b> | None           | Current file   |
|                  | <File No. 0~9> | Specified file |

**Example**  
 ->:FILE:SAVE  
 ->:FILE:SAVE 1

### :FILE:LOAD



**Description** To load instrument settings of current file or specified file to the system.

**Syntax** :FILE:L:OAD {None|<File No. 0~9>}

|                  |                |                |
|------------------|----------------|----------------|
| <b>Parameter</b> | None           | Current file   |
|                  | <File No. 0~9> | Specified file |

**Example**  
 ->:FILE:LOAD  
 ->:FILE:LOAD 1

### :FILE:DELeTe



**Description** To delete instrument settings of current file or specified file from the system.

**Syntax** :FILE:DEL {None|<File No. 0~9>}

---

|           |                |                |
|-----------|----------------|----------------|
| Parameter | None           | Current file   |
|           | <File No. 0-9> | Specified file |

---

|         |               |
|---------|---------------|
| Example | ->:FILE:DEL   |
|         | ->:FILE:DEL 1 |

---

## SCPI Commands

|         |     |
|---------|-----|
| *IDN?   | 175 |
| *ERRor? | 176 |
| *SAV    | 176 |

### \*IDN?



|                  |   |  |
|------------------|---|--|
| Description      | Queries the manufacturer, model number, serial number, and firmware version of the device.  |  |
| Query Syntax     | :*IDN? or :IDN?   |  |
| Return parameter | <character data>  | Returns the instrument identification as a character data in the following format:<br><br>GBM-3300,REV B1.21, GES110T4A, Good Will Instrument Co, Ltd.<br><br>Model number : GBM-3300<br><br>Firmware version : V1.X.X.X<br><br>Serial number : XXXXXXXX<br><br>Manufacturer: GWINSTEK |
| Example          | ->:IDN?<br>->GBM-3300,REV B1.21, GES110T4A, Good Will Instrument Co, Ltd.   |  |
| Note             | When receiving IDN? command, the instrument buzzer will sound to prompt to receive the information, and return the result.<br><br>This command is usually used for online testing when debugging communication. |  |

**\*ERRor?**

→ **Query**

**Description**            Queries the most recent error information. Please refer to page 164 for details about error code.

**Query Syntax**        :\*ERRor? or :ERRor?

**Example**                ->:ERR?  
                               ->\*E00 (No error)

**\*SAV**

**Set** →

**Description**            To save all modified settings to the device's internal memory.

**Syntax**                 :\*SAV or :SAV

**Example**                ->:SAV



# A

## PPENDIX

---

|   |     |
|---|-----|
| GBM-3300 Factory Default Settings ..... | 178 |
| Specifications .....                    | 180 |
| General Specifications .....            | 180 |
| AC Resistance.....                      | 181 |
| DC Voltage .....                        | 181 |
| Dimensions .....                        | 183 |
| Declaration of Conformity .....         | 184 |

## GBM-3300 Factory Default Settings

The following default settings are the factory configuration settings for the GBM-3300.

For details on how to return to the factory default settings, see page Restore to factory default setting 83.

| File           | Default Setting |
|----------------|-----------------|
| File No.       | 0               |
| File Media     | Internal        |
| File Recall    | File 0          |
| File Auto Save | 0               |
| System         | Default Setting |
| Baud           | 115200          |
| Terminator     | CR+LF           |
| Stop Bit       | 1               |
| Hand Shake     | OFF             |
| Error Code     | OFF             |
| Send Mode      | Fetch           |
| Protocol       | SCPI            |
| Key Lock       | OFF             |
| Key Beep       | ON              |
| Data Logger    | LOG             |
| Log Size       | 10,000          |
| Filter         | AUTO            |
| USB File       | Default Setting |
| USB File       | OFF             |
| Short Test     | Default Setting |
| Short          | ON              |
| Short Delay    | 0               |
| Setup          | Default Setting |
| FUNC           | R-V             |
| SPEED          | SLOW            |
| AVG            | 1               |
| SELF-CAL       | ON              |
| CURRENT        | CONTINUOUS      |
| RANGE MODE     | AUTO            |
| DELAY          | 0               |
| MONITOR        | OFF             |

---

|             |             |
|-------------|-------------|
| TRIGGER     | INT         |
| TRIG EDGE   | RISING EDGE |
| BIN Setup   | Setting     |
| R-COMP      | OFF         |
| V-COMP      | OFF         |
| R-COMP Mode | SEQ         |
| V-COMP Mode | SEQ         |
| BEEP        | OFF         |
| NOMINAL     | 0           |
| LOWER/UPPER | 0           |

## Specifications

Below are the basic conditions required to operate the GBM-3000 series within specification:

- Calibration: Yearly
- Reset adjustment: Perform short circuit clear before testing
- The specifications Apply when it warmed up for at least 60 minutes.
- Test current accuracy: 10%
- Test current frequency accuracy: 1kHz(±0.5Hz)

## General Specifications

### Specification Conditions:

Temperature: 18 °C~28 °C

Humidity: ≤ 70%RH (non-condensing)

### Operating Environment

Temperature Range: 0~40 °C

Relative Humidity: ≤ 70%RH (non-condensing)

### Storage Conditions

Temperature Range: -10~70 °C

Relative Humidity: ≤ 80%RH (non-condensing)

### General

Power Consumption: AC 100V~240V, 50/60Hz, Max.10W

Fuse: 250V 1A slow melting

Dimensions: 264 mm (W) X 107 mm (H) X 350 mm (D)

Weight: Approximately 2.8 kg

|         |              |                            |
|---------|--------------|----------------------------|
| Display | TFT LCD Type | 3.5" TFT LCD color display |
|---------|--------------|----------------------------|

|            |      |                |
|------------|------|----------------|
| Test speed | Slow | 3 time/ second |
|------------|------|----------------|

|        |                  |
|--------|------------------|
| Medium | 14 times/ second |
|--------|------------------|

|      |                  |
|------|------------------|
| Fast | 25 times/ second |
|------|------------------|

|              |                  |
|--------------|------------------|
| Extreme Fast | 65 times/ second |
|--------------|------------------|

|       |                                   |
|-------|-----------------------------------|
| Range | Auto range, Hold range, Nom range |
|-------|-----------------------------------|

|            |                  |
|------------|------------------|
| Comparator | ABS, PER and SEQ |
|------------|------------------|

|         |   |
|---------|---|
| Handler | Resistance HI/IN/LO, Voltage HI/IN/LO and |
|---------|---|

|        |                 |
|--------|-----------------|
| Buzzer | OFF, Pass, Fail |
|--------|-----------------|

|         |          |
|---------|----------|
| Trigger | INT, EXT |
|---------|----------|

|                      |             |
|----------------------|-------------|
| Interface            | RS232C      |
|                      | USB Port    |
|                      | Handler     |
| Programming language | SCPI        |
| Accessibility        | Keypad lock |

## AC Resistance

| Range No. | Range         | Maximum Displayed Values | Resolution      | Measured current |
|-----------|---------------|--------------------------|-----------------|------------------|
| 0         | 3m $\Omega$   | 3.1000m                  | 0.1 $\mu\Omega$ | 100mA            |
| 1         | 30m $\Omega$  | 31.000m                  | 1 $\mu\Omega$   | 100mA            |
| 2         | 300m $\Omega$ | 310.00m                  | 10 $\mu\Omega$  | 10mA             |
| 3         | 3 $\Omega$    | 3.1000                   | 100 $\mu\Omega$ | 1mA              |
| 4         | 30 $\Omega$   | 31.000                   | 1m $\Omega$     | 100 $\mu$ A      |
| 5         | 300 $\Omega$  | 310.00                   | 10m $\Omega$    | 10 $\mu$ A       |
| 6         | 3k $\Omega$   | 3200.0                   | 100m $\Omega$   | 10 $\mu$ A       |

| Range No. | Accuracy                        |                                 |                                 |                                 | Temperature coefficient                            |
|-----------|---------------------------------|---------------------------------|---------------------------------|---------------------------------|--|
|           | Slow                            | Medium                          | Fast                            | Ex. Fast                        |  |
| 0         | $\pm 0.5\%$ rdg<br>$\pm 10$ dgt | $\pm 0.5\%$ rdg<br>$\pm 15$ dgt | $\pm 0.5\%$ rdg<br>$\pm 20$ dgt | $\pm 0.5\%$ rdg<br>$\pm 40$ dgt | ( $\pm 0.05\%$ rdg<br>$\pm 1$ dgt)/ $^{\circ}$ C   |
| 1~6       | $\pm 0.5\%$ rdg<br>$\pm 5$ dgt  | $\pm 0.5\%$ rdg<br>$\pm 7$ dgt  | $\pm 0.5\%$ rdg<br>$\pm 7$ dgt  | $\pm 1\%$ rdg<br>$\pm 8$ dgt    | ( $\pm 0.05\%$ rdg<br>$\pm 0.5$ dgt)/ $^{\circ}$ C |

## DC Voltage

| Range No. | Range                    | Maximum Displayed Values | Resolution  |
|-----------|--------------------------|--------------------------|-------------|
| 0         | 8V                       | $\pm 8.08000$            | 10 $\mu$ V  |
| 1         | 80V                      | $\pm 80.8000$            | 100 $\mu$ V |
| 2         | 300V (For GBM-3300 only) | $\pm 303.000$            | 1mV         |

| Range No. | Accuracy                        |                                 |                                 |                                | Temperature coefficient                             |
|-----------|---------------------------------|---------------------------------|---------------------------------|--------------------------------|---|
|           | Slow                            | Medium                          | Fast                            | Ex. Fast                       |   |
| 0~2       | $\pm 0.01\%$<br>rdg $\pm 3$ dgt | $\pm 0.01\%$<br>rdg $\pm 5$ dgt | $\pm 0.05\%$<br>rdg $\pm 5$ dgt | $\pm 0.1\%$ rdg<br>$\pm 6$ dgt | ( $\pm 0.001\%$ rdg<br>$\pm 0.3$ dgt)/ $^{\circ}$ C |

If the instrument is used in areas with electromagnetic interference, the measurement accuracy may be affected. In this case, shielded mesh test lines can be used to reduce the impact on the measurement. It is recommended to use GTL-308 test lead with GBM-G1 ground lead to connect to the Frame Terminal on the back of the machine.

|   |  |
|---|--|
| Effect of radiated radio-frequency electromagnetic field(10V/m) | Resistance: $\pm 10\%rdg \pm 8000dgt$  |
|   | Voltage: $\pm 0.01\%rdg \pm 50dgt$     |
| Effect of conducted radio-frequency electromagnetic field(3V)   | Resistance: $\pm 0.5\%rdg \pm 1000dgt$ |

## Dimensions

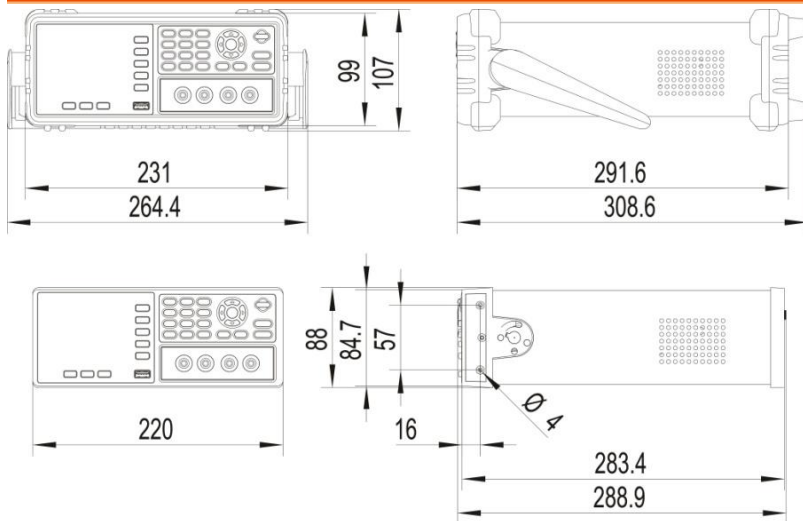

## Declaration of Conformity

We

**GOOD WILL INSTRUMENT CO., LTD.**

declare that the below mentioned product

**Type of Product: Battery meter**

**Model Number: GBM-3300/ GBM-3080**

satisfies all the technical relations application to the product within the scope of council:

**Directive:** 2014/30/EU; 2014/35/EU; 2011/65/EU; 2012/19/EU

The above product is in conformity with the following standards or other normative documents:

| © EMC   |  |
|---|--|
| EN 61326-1 :  | Electrical equipment for measurement, control and laboratory use — EMC requirements (2013) |
| EN 61326-2-1:   |  |
| Conducted and Radiated Emissions<br>EN 55011: 2009+A1: 2010 Class A | Electrical Fast Transients<br>EN 61000-4-4: 2012   |
| Current Harmonic<br>EN 61000-3-2: 2014                              | Surge Immunity<br>EN 61000-4-5: 2014   |
| Voltage Fluctuation<br>EN 61000-3-3: 2013                           | Conducted Susceptibility<br>EN 61000-4-6: 2014   |
| Electrostatic Discharge<br>EN 61000-4-2: 2009                       | Power Frequency Magnetic Field<br>EN 61000-4-8: 2010                                       |
| Radiated Immunity<br>EN 61000-4-3: 2006+A1: 2008+A2: 2010           | Voltage Dips/ Interrupts<br>EN 61000-4-11: 2004  |
| Low Voltage Equipment Directive 2014/35/EU                          |  |
| Safety Requirements   | EN 61010-1: 2010<br>EN 61010-2-030: 2010   |

**GOODWILL INSTRUMENT CO., LTD.**

No. 7-1, Jhongsing Road, Tucheng District, New Taipei City 236, Taiwan

Tel: [+886-2-2268-0389](tel:+886-2-2268-0389)

Fax: [+886-2-2268-0639](tel:+886-2-2268-0639)

Web: <http://www.gwinstek.com>

Email: [marketing@goodwill.com.tw](mailto:marketing@goodwill.com.tw)

**GOODWILL INSTRUMENT (SUZHOU) CO., LTD.**

No. 521, Zhujiang Road, Snd, Suzhou Jiangsu 215011, China

Tel: [+86-512-6661-7177](tel:+86-512-6661-7177)

Fax: [+86-512-6661-7277](tel:+86-512-6661-7277)

Web: <http://www.instek.com.cn>

Email: [marketing@instek.com.cn](mailto:marketing@instek.com.cn)

**GOODWILL INSTRUMENT EURO B.V.**

De Run 5427A, 5504DG Veldhoven, The Netherlands

Tel: [+31-\(0\)40-2557790](tel:+31-(0)40-2557790)

Fax: [+31-\(0\)40-2541194](tel:+31-(0)40-2541194)

Email: [sales@gw-instek.eu](mailto:sales@gw-instek.eu)