

Arbitrary Function Generator

AFG-3000 Series

USER MANUAL

GW INSTEK PART NO. 82FG-30820E01



ISO-9001 CERTIFIED MANUFACTURER

GW INSTEK

October 2010 edition

This manual contains proprietary information, which is protected by copyright. All rights are reserved. No part of this manual may be photocopied, reproduced or translated to another language without prior written consent of Good Will Corporation.

The information in this manual was correct at the time of printing. However, Good Will continues to improve its products and therefore reserves the right to change the specifications, equipment, and maintenance procedures at any time without notice.

Good Will Instrument Co., Ltd.
No. 7-1, Jhongsing Rd., Tucheng City, Taipei County 236, Taiwan.

Table of Contents

S AFETY INSTRUCTIONS.....	6
G ETTING STARTED.....	11
Main Features	11
Panel Overview.....	13
Setting up the Function Generator	19
Q UICK REFERENCE	21
How to use the Digital Inputs	23
How to use the Help Menu	24
Selecting a Waveform	26
Modulation.....	28
Sweep.....	32
Burst	33
ARB	35
Utility Menu	39
Menu Tree	42
Default Settings	53
O PERATION	55
Select a Waveform	56
M ODULATION	65
Amplitude Modulation (AM)	67
Frequency Modulation (FM)	75
Frequency Shift Keying (FSK) Modulation.....	83
Pulse Width Modulation	90
Frequency Sweep	97
Burst Mode	108

SECONDARY SYSTEM FUNCTION SETTINGS

.....	121
Save and Recall	122
Selecting the Remote Interface	125
System and Settings	129

ARBITRARY WAVEFORMS 137

Inserting Built-In Waveforms	138
Display an Arbitrary Waveform	151
Editing an Arbitrary Waveform	158
Output an Arbitrary Waveform	168
Saving/Loading an Arbitrary Waveform	174

REMOTE INTERFACE 182

Establishing a Remote Connection	183
Command Syntax	188
Command List	193
System Commands	196
Status Register Commands	200
Interface Configuration Commands	203
Apply Commands	204
Output Commands	211
Pulse Configuration Commands	221
Amplitude Modulation (AM) Commands	223
AM Overview	223
Frequency Modulation (FM) Commands	228
FM Overview	228
Frequency-Shift Keying (FSK) Commands	233
FSK Overview	233
Pulse Width Modulation (PWM) Commands	236
PWM Overview	236
Frequency Sweep Commands	241
Sweep Overview	241
Burst Mode Commands	251

Burst Mode Overview	251
Arbitrary Waveform Commands	262
Arbitrary Waveform Overview	262
Save and Recall Commands	273
Error Messages	275
SCPI Status Registers	289
APPENDIX	295
Fuse Replacement	295
AFG-3000 Series Specifications	296
EC Declaration of Conformity	302
INDEX	303

S SAFETY INSTRUCTIONS

This chapter contains important safety instructions that should be followed when operating and storing the function generator. Read the following before any operation to ensure your safety and to keep the function generator in the best condition.

Safety Symbols

These safety symbols may appear in this manual or on the instrument.



Warning: Identifies conditions or practices that could result in injury or loss of life.



Caution: Identifies conditions or practices that could result in damage to the function generator or to other objects or property.



DANGER High Voltage



Attention: Refer to the Manual



Protective Conductor Terminal



Earth (Ground) Terminal



DANGER Hot Surface



Double Insulated



Do not dispose electronic equipment as unsorted municipal waste. Please use a separate collection facility or contact the supplier from which this instrument was purchased.

Safety Guidelines

General Guideline



CAUTION

- Do not place heavy objects on the instrument.
- Do not place flammable objects on the instrument.
- Avoid severe impact or rough handling that may damage the function generator.
- Avoid discharges of static electricity on or near the function generator.
- Use only mating connectors, not bare wires, for the terminals.
- The instrument should only be disassembled by a qualified technician.

(Measurement categories) EN 61010-1:2001 specifies the measurement categories and their requirements as follows. The AFG-3000 falls under category II.

- Measurement category IV is for measurement performed at the source of a low-voltage installation.
- Measurement category III is for measurement performed in a building installation.
- Measurement category II is for measurement performed on circuits directly connected to a low voltage installation.
- Measurement category I is for measurements performed on circuits not directly connected to Mains.

Power Supply



WARNING

- AC Input voltage: 100 ~ 240V AC, 50 ~ 60Hz.
 - Connect the protective grounding conductor of the AC power cord to an earth ground to prevent electric shock.
-

Fuse



WARNING

- Fuse type: T0.63A/250V.
 - Only qualified technicians should replace the fuse.
 - To ensure fire protection, replace the fuse only with the specified type and rating.
 - Disconnect the power cord and all test leads before replacing the fuse.
 - Make sure the cause of fuse blowout is fixed before replacing the fuse.
-

Cleaning the
function
generator

- Disconnect the power cord before cleaning the function generator.
 - Use a soft cloth dampened in a solution of mild detergent and water. Do not spray any liquid into the function generator.
 - Do not use chemicals containing harsh products such as benzene, toluene, xylene, and acetone.
-

Operation
Environment

- Location: Indoor, no direct sunlight, dust free, almost non-conductive pollution (Note below) and avoid strong magnetic fields.
- Relative Humidity: < 80%
- Altitude: < 2000m
- Temperature: 0°C to 40°C

(Pollution Degree) EN 61010-1:2001 specifies pollution degrees and their requirements as follows. The function generator falls under degree 2.

Pollution refers to “addition of foreign matter, solid, liquid, or gaseous (ionized gases), that may produce a reduction of dielectric strength or surface resistivity”.

- Pollution degree 1: No pollution or only dry, non-conductive pollution occurs. The pollution has no influence.
- Pollution degree 2: Normally only non-conductive pollution occurs. Occasionally, however, a temporary conductivity caused by condensation must be expected.
- Pollution degree 3: Conductive pollution occurs, or dry, non-conductive pollution occurs which becomes conductive due to condensation which is expected. In such conditions, equipment is normally protected against exposure to direct sunlight, precipitation, and full wind pressure, but neither temperature nor humidity is controlled.

Storage environment

- Location: Indoor
- Relative Humidity: < 70%
- Temperature: -10°C to 70°C

Disposal



Do not dispose this instrument as unsorted municipal waste. Please use a separate collection facility or contact the supplier from which this instrument was purchased. Please make sure discarded electrical waste is properly recycled to reduce environmental impact.

Power cord for the United Kingdom

When using the function generator in the United Kingdom, make sure the power cord meets the following safety instructions.

NOTE: This lead/appliance must only be wired by competent persons

 **WARNING: THIS APPLIANCE MUST BE EARTHED**

IMPORTANT: The wires in this lead are coloured in accordance with the following code:

Green/ Yellow:	Earth
Blue:	Neutral
Brown:	Live (Phase)



As the colours of the wires in main leads may not correspond with the coloured marking identified in your plug/ appliance, proceed as follows:

The wire which is coloured Green & Yellow must be connected to the Earth terminal marked with either the letter E, the earth symbol (⊕) or coloured Green/Green & Yellow.

The wire which is coloured Blue must be connected to the terminal which is marked with the letter N or coloured Blue or Black.

The wire which is coloured Brown must be connected to the terminal marked with the letter L or P or coloured Brown or Red.

If in doubt, consult the instructions provided with the equipment or contact the supplier.

This cable/ appliance should be protected by a suitably rated and approved HBC mains fuse: refer to the rating information on the equipment and/or user instructions for details. As a guide, a cable of 0.75mm² should be protected by a 3A or 5A fuse. Larger conductors would normally require 13A types, depending on the connection method used.

Any exposed wiring from a cable, plug or connection that is engaged in a live socket is extremely hazardous. If a cable or plug is deemed hazardous, turn off the mains power and remove the cable, any fuses and fuse assemblies. All hazardous wiring must be immediately destroyed and replaced in accordance to the above standard.

G E T T I N G S T A R T E D

The Getting started chapter introduces the function generator's main features, appearance, set up procedure and power-up.

Main Features

Model name	Frequency bandwidth
AFG-3081	80MHz
AFG-3051	50MHz
Performance	<ul style="list-style-type: none"> • DDS Function Generator series • 1μHz high frequency resolution maintained at full range • 1ppm frequency stability • Full Function Arbitrary Waveform Capability <ul style="list-style-type: none"> 200 MSa/s sample rate 100 MSa/s repetition rate 1 M-point waveform length 16-bit amplitude resolution Ten 1M waveform memories True waveform output to display User define output section User defined marker output section D W R (Direct Waveform Reconstruction) capability Waveform editing capability sans PC N Cycle and Infinite output mode selectable

	<ul style="list-style-type: none">• -60dBc low distortion sine wave
Features	<ul style="list-style-type: none">• Sine, Square, Ramp, Pulse, Noise, Sinc standard waveforms• Internal and external LIN/LOG sweep with marker output• Int/Ext AM, FM, PWM, FSK modulation• Modulation/sweep signal output• Burst function with internal and external triggers without marker output• Store/recall 10 groups of setting memories• Output overload protection
Interface	<ul style="list-style-type: none">• GPIB, RS232, USB standard interfaces• 4.3 inch Color TFT LCD (480 × 272) Graphical User Interface.• AWES (Arbitrary Waveform Editing Software) PC software

Panel Overview

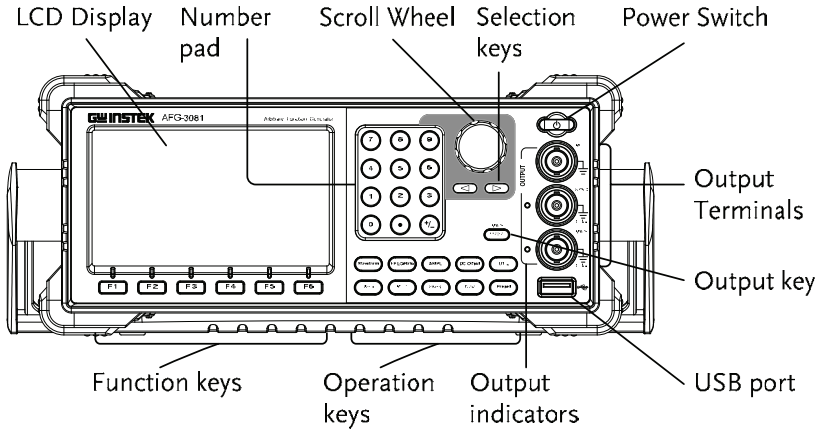

Front Panel



LCD display TFT color LCD display, 480 x 272 resolution.

Function keys: F1~F6  Activates the functions which appear in the bottom of the LCD display.

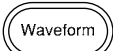
Operation keys

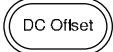
-  Waveform is used to select a waveform type.
-  The FREQ/Rate key is used to set the frequency or sample rate
-  AMPL sets the waveform amplitude.
-  Sets the DC offset.



The UTIL key is used to access the save and recall options, set the remote interface (USB, GPIB, RS232), use DSO link, update and view the firmware version, access the calibration options, output impedance settings, set the language and access the help menu.



ARB is used to set the arbitrary waveform parameters.



The MOD, Sweep and Burst keys are used to set the modulation, sweep and burst settings and parameters.



Preset



The preset key is used to recall a preset state.

Output key

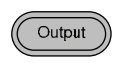

The Output key is used to turn on or off the waveform output.

Output indicators

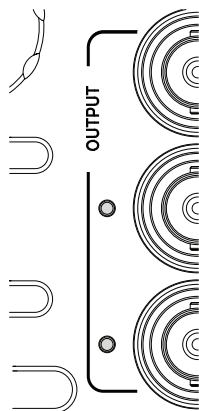

When an Output indicator is green, it indicates that the output is active.

USB host connector

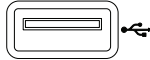

The USB Host connector is used to save and restore waveform data and images, as well as update the firmware.

Output terminals



Modulation output terminal.

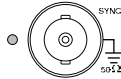

The SYNC output terminal. 50Ω output impedance.

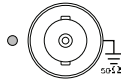

The primary output terminal. 50Ω output impedance.

Standby key

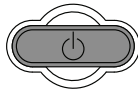

The standby key is used to turn the function generator on (green) or to put the function generator into standby mode (red).

Selection keys



Used to select digits when editing parameters.

Scroll Wheel

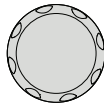

The scroll wheel is used to edit values and parameters.

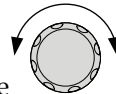

Decrease

Increase

Keypad

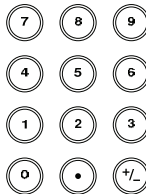

The digital keypad is used to enter values and parameters. The keypad is often used in conjunction with the selection keys and variable knob.

Rear Panel

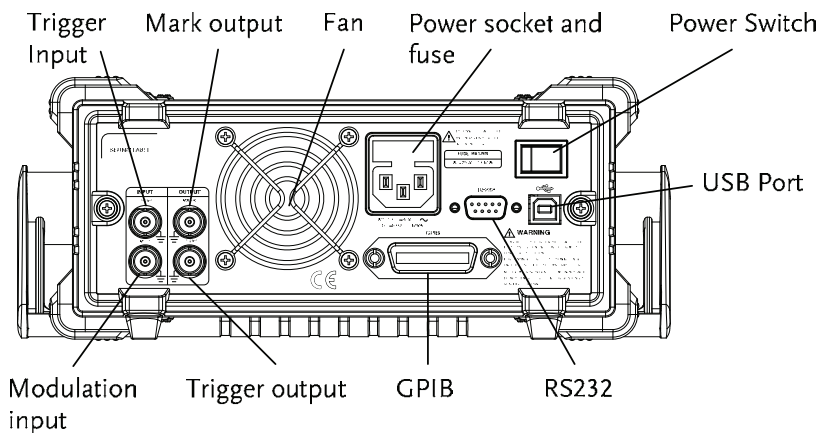

Trigger input



External trigger input. Used to receive external trigger signals.

MARK output



Mark output signal. Used for Sweep and ARB mode only.

Fan

Power Socket
Input and fuse

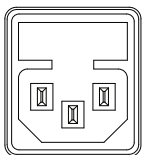

Power input: 100~240V AC
50~60Hz.

Fuse: T0.63A/250V

For the fuse replacement procedure, see page 295.

Power Switch

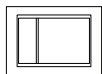

Main power switch.

USB port



The Mini-B type USB connector is used to connect the function generator to a PC for remote control.

RS232 port  9 pin female RS232 socket used for PC remote control.

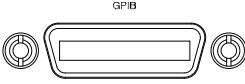
GPIB  24 pin female GPIB connector for PC remote control.

Trigger output  Trigger output terminal.

MOD input  Modulation input terminal.

Display

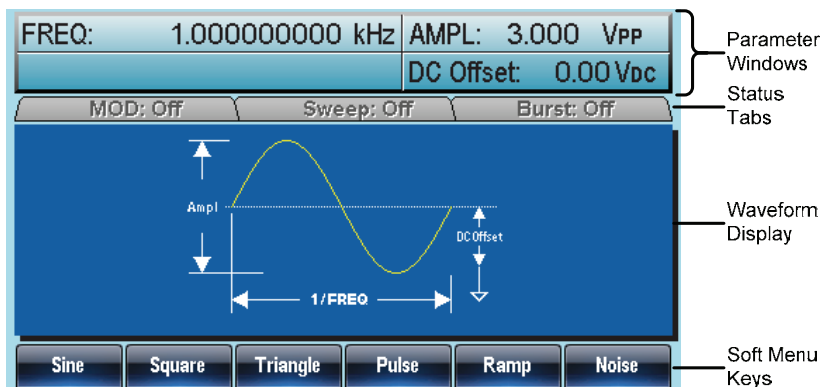

Parameter Windows The Parameter display and edit window.

Status Tabs Shows the status of MOD, Sweep and Burst modes.

Waveform Display The Waveform Display is used to output the waveform on the display.

Soft Menu Keys The function keys (F1~F6) below the Soft Menu keys correspond to the soft keys.

Setting up the Function Generator

Background This section describes how adjust the handle and power up the function generator.

Adjusting the stand Pull out the handle sideways and rotate it.

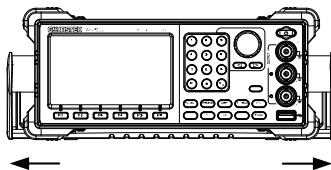

Place AFG horizontally,

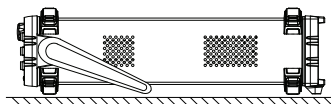

Or tilt stand.

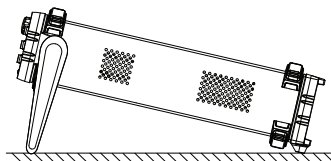

Place the handle vertically to hand carry.

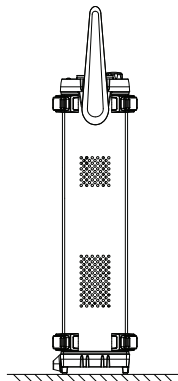

Power Up

1. Connect the power cord to the socket on the rear panel.

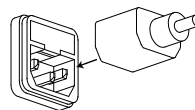

2. Turn on the power switch on the rear panel.

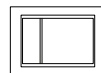

3. Press and hold the Standby key on the front panel to turn the machine on. The standby key will change from red (standby) to green (on).

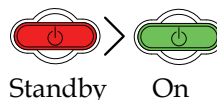

4. When the standby key turns green, the instrument will turn on showing a loading screen.



Made to Measure.

Loading ○○○○

The function generator is now ready to be used.

QUICK REFERENCE

This chapter lists operation shortcuts, built-in help coverage, and default factory settings. Use this chapter as a handy reference for instrument functions. This chapter is to be used as a quick reference, for detailed explanations on parameters, settings and limitations, please see the operation chapter (page 55) or specifications (page 296).

How to use the Digital Inputs	23
How to use the Help Menu	24
Selecting a Waveform	26
Square Wave.....	26
Triangle Wave.....	26
Sine Wave.....	27
Modulation.....	28
AM	28
FM	29
FSK Modulation.....	30
PWM Modulation.....	31
Sweep.....	32
Burst	33
ARB	35
ARB – Add Built-In Waveform.....	35
ARB – Add Built-In Waveform - Pulse.....	35
ARB - Add Point.....	36
ARB - Add Line	36
ARB – Output Section	37
ARB – Output N Cycle.....	37
ARB – Output Infinite Cycles	38
ARB – Output Markers.....	39
Utility Menu	39
Save	39
Recall	40
Interface GPIB	40
Interface RS232	41

Interface USB	41
Menu Tree	42
Waveform	43
ARB-Display.....	43
ARB-Edit	44
ARB-Built in	45
ARB- Built in- More	46
ARB-Save	47
ARB-Load.....	47
ARB-Output.....	48
MOD	49
Sweep	49
Sweep - More	50
Burst – N Cycle	51
Burst - Gate	51
UTIL.....	52
UTIL - Interface	52
Default Settings.....	53

How to use the Digital Inputs

Background

The AFG-3000 has three main types of digital inputs: the number pad, selection keys and scroll wheel. The following instructions will show you how to use the digital inputs to edit parameters.

1. To select a menu item, press the corresponding function keys below (F1~F6). For example the function key F1 corresponds to the Soft key "Sine".

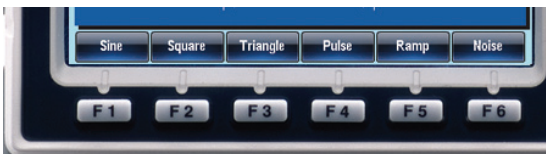

2. To edit a digital value, use the selector key to move the cursor to the digit that needs to be edited.



3. Use the scroll wheel to edit the digit under the cursor. Clockwise increases the value, counterclockwise decreases the value.

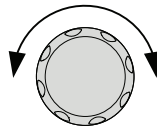

4. Alternatively, the number pad can be used to set the value of a highlighted parameter.

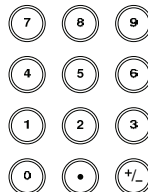

How to use the Help Menu

Background Every key and function has a detailed description in the help menu.

1. Press UTIL.



2. Press System (F5).



3. Press Help (F3).



4. Use the scroll wheel to navigate to a help item. Press Select to choose the item.

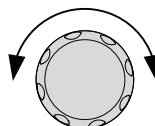

Keypad	Provides help on any front panel key that is pressed.
Create Arbitrary Waveform	Provides help on creating arbitrary waveforms.
Modulation Function	Explains how to create Modulated waveforms.
Sweep Function	Provides help on the Sweep function.

- Burst Function Provides help on the Burst function.
- DSO Link Provides help on DSO link.
- Hardcopy Explains how to use the Hardcopy function.

5. For example select item 4 to see help on the sweep function.

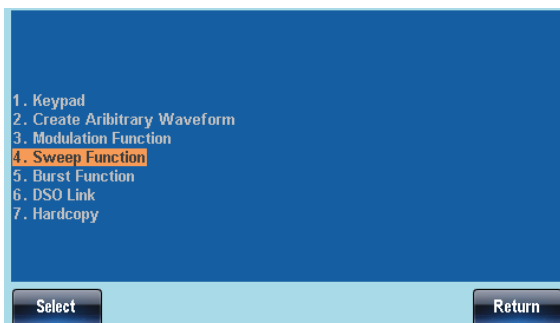

6. Use the scroll wheel to navigate to each help page.

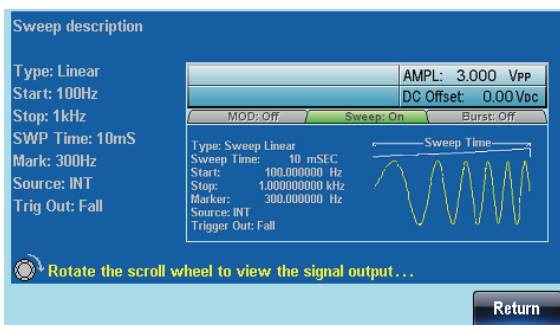

7. Press F6 to return to the previous menus.



Selecting a Waveform

Square Wave

Example: Square Wave, 3Vpp, 75% Duty, 1 kHz

Output

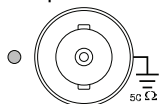

1. Press the Waveform key and select Square (F2).



2. Press Duty (F1), followed by 7 + 5 + % (F5)



Input: N/A

3. Press the Freq/Rate key, followed by 1 + kHz (F5).



4. Press the AMPL key, followed by 3 + VPP (F6).



5. Press the output key.



Triangle Wave

Example: Triangle Wave, 5Vpp, 10kHz

Output

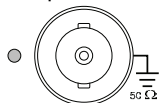



1. Press the Waveform key and select Triangle (F3).



2. Press the Freq/Rate key, followed by 1 + 0 + kHz (F5).



Input: N/A

3. Press the AMPL key, followed by 5 +VPP (F6).
 
4. Press the output key.
 



Sine Wave

Example: Sine Wave, 10Vpp,100kHz

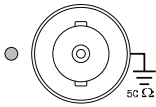
Output

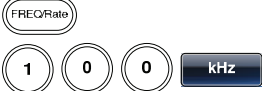

Input: N/A

1. Press the Waveform key and select Sine (F1).
 
2. Press the Freq/Rate key, followed by 1 + 0 + 0 + kHz (F5).
 
3. Press the AMPL key, followed by 1 + 0 +VPP (F6).
 
4. Press the output key.
 

Modulation

AM

Example: AM modulation. 100Hz modulating square wave. 1kHz Sine wave carrier. 80% modulation depth.

Output

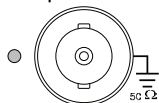

Input: N/A

1. Press the MOD key and select AM (F1).



2. Press Waveform and select Sine (F1).



3. Press the Freq/Rate key, followed by 1 + kHz (F5).



4. Press the MOD key, select AM (F1), Shape (F4), Square (F2).



5. Press the MOD key, select AM (F1), AM Freq (F3).



6. Press 1 + 0 + 0 + Hz (F2).





7. Press the MOD key, select AM (F1), Depth (F2).



8. Press 8 + 0 + % (F1).



9. Press MOD, AM (F1), Source (F1), INT (F1).
 
10. Press the output key.
 





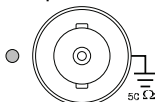

FM



Example: FM modulation. 100Hz modulating square wave. 1kHz Sine wave carrier. 100 Hz frequency deviation. Internal Source.

Output

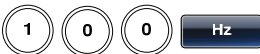

Input: N/A

1. Press the MOD key and select FM (F2).
 
2. Press Waveform and select Sine (F1).
 
3. Press the Freq/Rate key, followed by 1 + kHz (F5).
 
4. Press the MOD key, select FM (F2), Shape (F4), Square (F2).
 
5. Press the MOD key, select FM (F2), FM Freq (F3).
 
6. Press 1 + 0 + 0 + Hz (F2).
 
7. Press the MOD key, select FM (F2), Freq Dev (F2).
 



8. Press 1 + 0 + 0 + Hz (F3). 
9. Press MOD, FM (F2), Source (F1), INT (F1). 
10. Press the output key. 

FSK Modulation



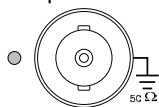

Example: FSK modulation. 100Hz Hop frequency. 1kHz Carrier wave. Triangle wave. 10 Hz Rate. Internal Source.



Output



1. Press the MOD key and select FSK (F3). 
2. Press Waveform and select Triangle (F3). 

Input: N/A

3. Press the Freq/Rate key, followed by 1 + kHz (F5). 
4. Press the MOD key, select FSK (F3), FSK Rate (F3). 
5. Press 1 + 0 + Hz (F2). 
6. Press the MOD key, select FSK (F3), Hop Freq (F2). 





7. Press 1 + 0 + 0 + Hz (F3). 
8. Press MOD, FSK (F3), Source (F1), INT (F1). 
9. Press the output key. 

PWM Modulation

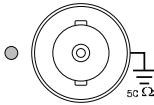

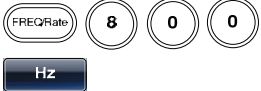

Example: PWM modulation. 800Hz Carrier wave. 15 kHz modulating sine wave. 50% Duty Cycle. Internal Source.

Output



1. Press Waveform and select Square (F2). 
2. Press the MOD key and select PWM (F4). 
3. Press the Freq/Rate key, followed by 8 + 0 + 0 + Hz (F4). 
4. Press the MOD key, select PWM (F4), Shape (F4), Sine (F1). 
5. Press the MOD key, PWM (F4), PWM Freq (F3). 

Input: N/A

- 6. Press 1 + 5 + kHz (F3). 
- 7. Press MOD, PWM (F4), Duty (F2). 
- 8. Press 5 + 0 + % (F1). 
- 9. Press MOD, PWM (F4), Source (F1), INT (F1). 
- 10. Press the output key. 





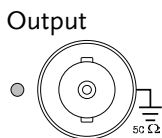

















Sweep

Example: Frequency Sweep. Start Frequency 10mHz, Stop frequency 1MHz. Log sweep, 1 second sweep, Marker Frequency 550 Hz, Manual Trigger, Trigger out, rising edge.



- 1. Press Sweep, Start (F3). 
- 2. Press 1 + 0 + mHz (F2). 
- 3. Press Sweep, Stop (F4). 
- 4. Press 1 + MHz (F5). 
- 5. Press Sweep, Type (F2), Log (F2). 

Input: N/A





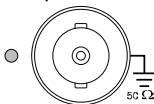

6. Press Sweep, SWP Time (F5).  
7. Press 1 + SEC (F2).  
8. Press Sweep, More (F6), Marker (F3), ON/OFF (F2), Freq (F1).     
9. Press 5 + 5 + 0 + Hz (F3)    
10. Press Sweep, More (F6), TRIG out (F4), ON/OFF (F3), Rise (F1).     
11. Press the output key. 
12. Press Sweep, Source (F1), Manual (F3), Trigger (F1).    

Burst



Example: Burst Mode, N-Cycle (Internally triggered), 1kHz burst frequency, Burst count = 5, 10 ms Burst period, 0° burst phase, Internal trigger, 10 us delay, rising edge trigger out



Output









1. Press FREQ/Rate 1 kHz (F5).   
2. Press Burst, N Cycle (F1), Cycles (F1).   



Input: N/A





3. Press 5 + Cyc (F5).  





4. Press Burst, N Cycle (F1), Period (F4).   



5. Press 1 + 0 + msec (F2).   







6. Press Burst, N Cycle (F1), Phase (F3).   

7. Press 0 + Degree (F5).  

8. Press Burst, N Cycle (F1), TRIG Setup (F5), INT (F1).   

9. Press Burst, N Cycle (F1), TRIG Setup (F5), Delay (F4).   

10. Press 1 + 0 + uSEC (F2).   

11. Press Burst, N Cycle (F1), TRIG Setup (F5), TRIG out (F5), ON/OFF (F3), Rise (F1).   
  

12. Press the output key. 

ARB

ARB – Add Built-In Waveform

Example: ARB Mode, Exponential Rise. Start 0, Length 100, Scale 32767.

Output

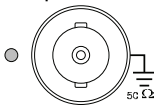

1. Press ARB, Built in (F3), More (F5), Exp Rise (F1).



2. Press Start (F1), 0 + Enter (F5), Return (F6).



3. Press Length (F2), 100, Enter (F5), Return (F6).



4. Press Scale (F3), 32767, Enter (F5), Return (F6), Done (F4).

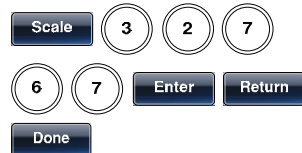

ARB – Add Built-In Waveform - Pulse

Example: ARB Mode, Pulse. Start 0, Frequency 1kHz, Duty 25%.

Output

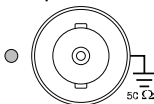

5. Press ARB, Built in (F3), More (F5), Exp Rise (F1).



6. Press Freq.(F1),1, kHz (F5), Return (F6).



7. Press Duty (F2), 25, % (F5), Return (F6).



8. Press Scale (F3), 32767, Enter (F5), Return (F6), Done (F4).

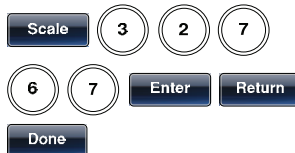

ARB - Add Point

Example: ARB Mode, Add point, Address 40, data 30,000.

Output

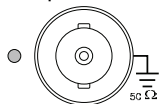

1. Press ARB, Edit (F2), Point (F1), Address (F1).



2. Press 4 + 0 + Enter (F5), Return (F6).



3. Press Data (F2), 3+0+0+0+0, Enter (F5).



ARB - Add Line

Example: ARB Mode, Add line, Address:Data (10:30, 50:100)

Output

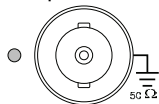

1. Press ARB, Edit (F2), Line (F2), Start ADD (F1).





2. Press 1 + 0 + Enter (F5), Return (F6).





3. Press Start Data (F2), 3 + 0, Enter (F5), Return (F6).















4. Press Stop ADD (F3), 5 + 0, Enter (F5), Return (F6).















5. Press Stop Data (F4), 1 + 0 + 0, Enter (F5), Return (F6), Done (F5).



















ARB – Output Section

Example: ARB Mode, Output ARB Waveform, Start 0, Length 1000.

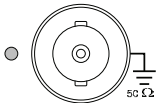
Output





1. Press ARB, Output (F6).







2. Press Start (F1), 0 + Enter (F5), Return (F6).













3. Press Length (F2), 1 + 0 + 0, Enter (F5), Return (F6).



















ARB – Output N Cycle

Example: ARB Mode, Output N Cycle, Start 0, Length 1000, N Cycle 10.

Output

1. Press ARB, Output (F6).





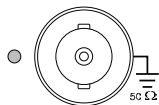

2. Press Start (F1), 0 + Enter (F5), Return (F6).



3. Press Length (F2), 1 + 0 + 0, Enter (F5), Return (F6).



4. Press N Cycle (F4).



5. Press Cycles (F1), 1 + 0.



6. To trigger the output once, press Trigger (F5).



ARB – Output Infinite Cycles

Example: ARB Mode, Output N Cycle, Start 0, Length 1000, Cycles Infinite.

Output

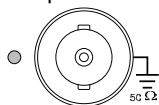

1. Press ARB, Output (F6).



2. Press Start (F1), 0 + Enter (F5), Return (F6).



3. Press Length (F2), 1 + 0 + 0, Enter (F5), Return (F6).



4. Press Infinite (F5), Return (F6).



ARB – Output Markers

Example: ARB Mode, Output Markers, Start 0, Length 80.

Output

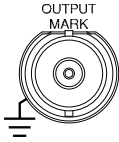

1. Press ARB, Output (F6), Marker (F3).



2. Press Start (F1), 3+0, Enter (F5), Return (F6).



3. Press Length (F2), 8 + 0, Enter (F5), Return (F6).



Utility Menu

Save

Example: Save to Memory file #5.

1. Press UTIL, Memory (F1), Store (F1).



2. Choose a file using the scroll wheel and Select (F1), press Done (F5).



Recall

Example: Recall Memory file #5.

1. Press UTIL, Memory (F1), Recall (F2).



2. Choose a file using the scroll wheel and Select (F1), press Done (F5).



Interface GPIB

Example: GPIB interface, Address 10.

GPIB

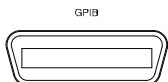

1. Press UTIL, Interface (F2), GPIB (F1), Address (F1).



2. Press 1 + 0 + Done (F5).



Interface RS232

Example: RS232 interface, Baud 115200, Parity None, Bits 8.

RS232

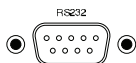

1. Press UTIL,
Interface (F2), RS232
(F2).



2. Press Baud Rate
(F1), 115k (F5).



3. Press UTIL,
Interface (F2), RS232
(F2).



4. Press Parity/Bits
(F2), None/8Bits
(F1).



Interface USB

Example: USB interface.

USB B



1. Press UTIL,
Interface (F2), USB
(F3).



Menu Tree

Convention Use the menu trees as a handy reference for the function generator functions and properties. The AFG-3000 menu system is arranged in a hierarchical tree. Each hierarchical level can be navigated with the operation or soft menu keys. Pressing the Return soft key will return you to the previous menu level.

For example: To set the parity to Even/7Bits;

- (1) Press the UTIL key.
- (2) The Interface softkey.
- (3) RS232.
- (4) Parity/Bits
- (5) Even/7Bits.

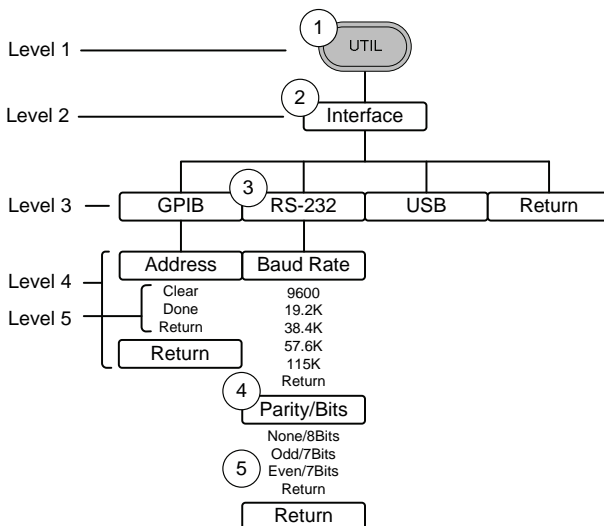

Waveform

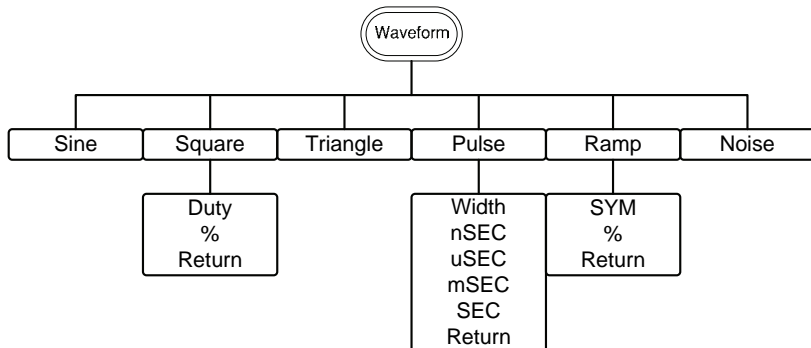

ARB-Display

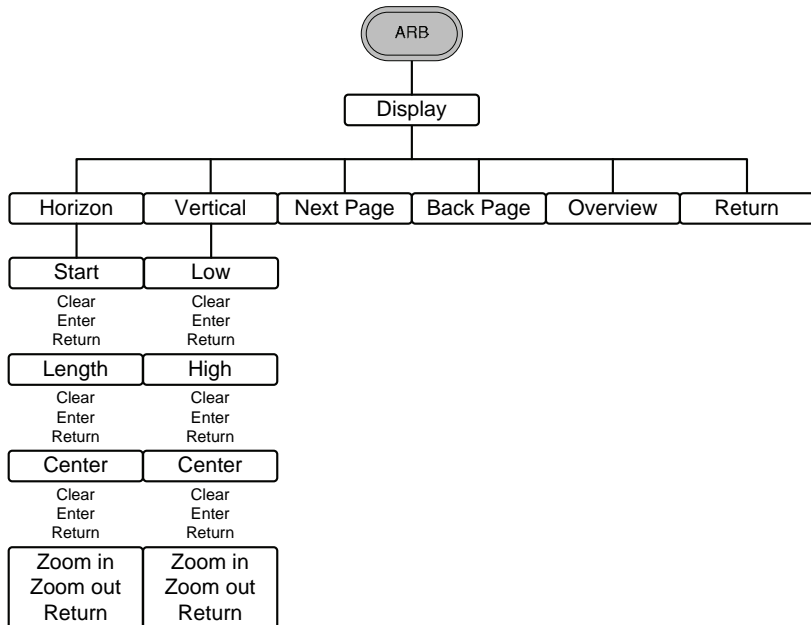

ARB-Edit

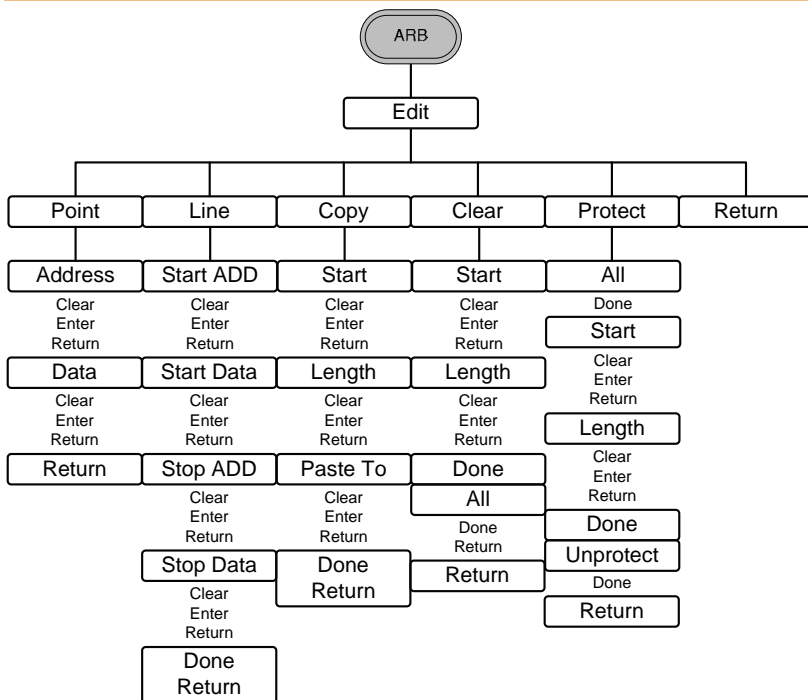

ARB-Built in

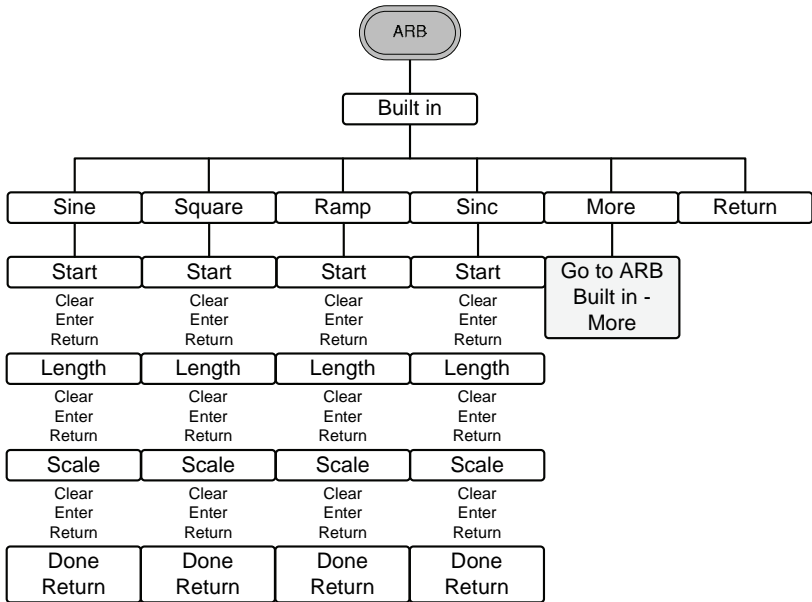

ARB- Built in- More

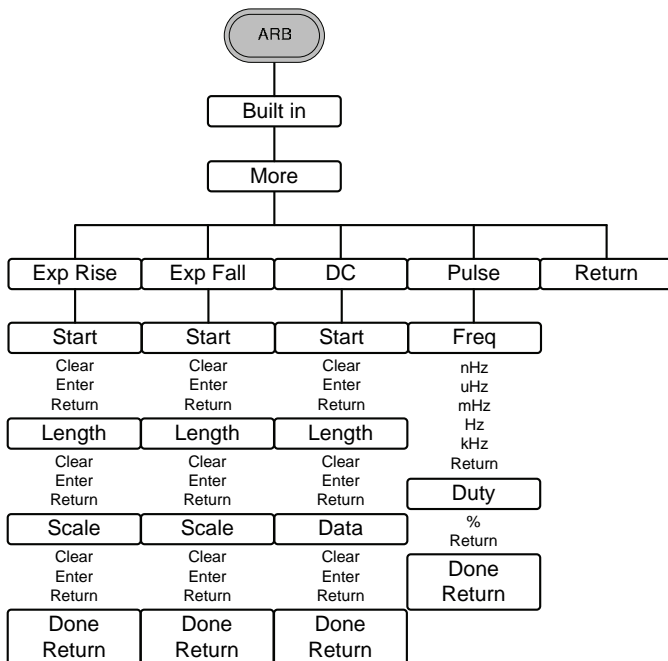

ARB-Save

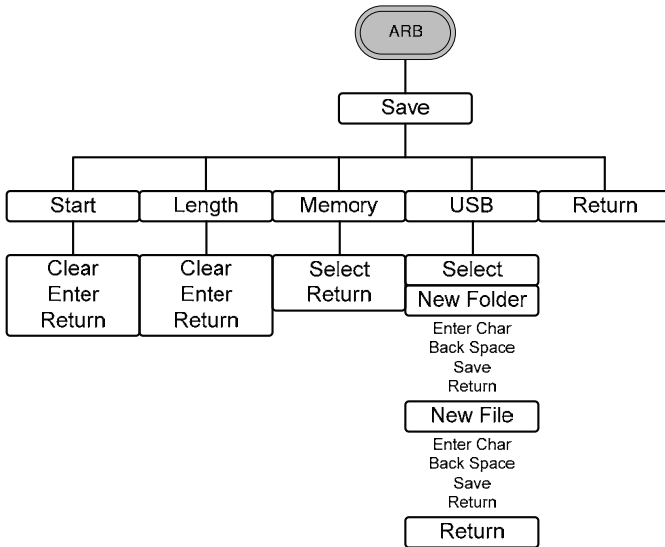

ARB-Load

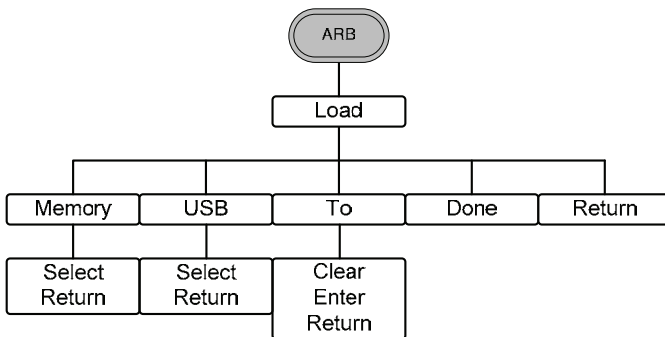

ARB-Output

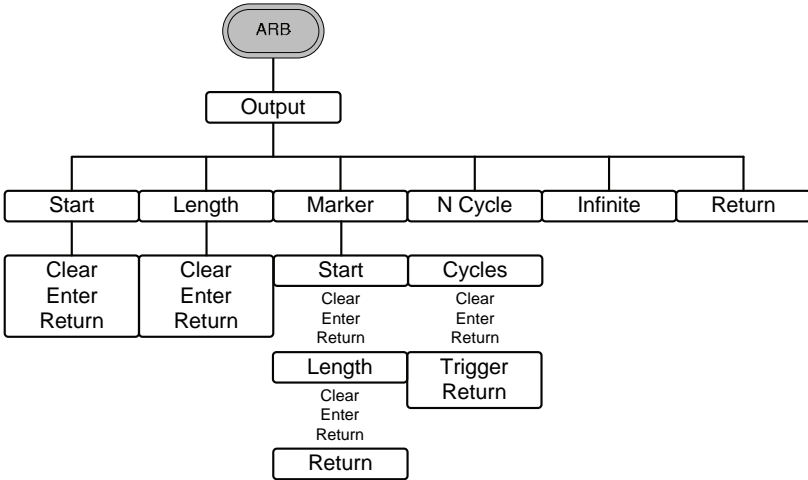

MOD

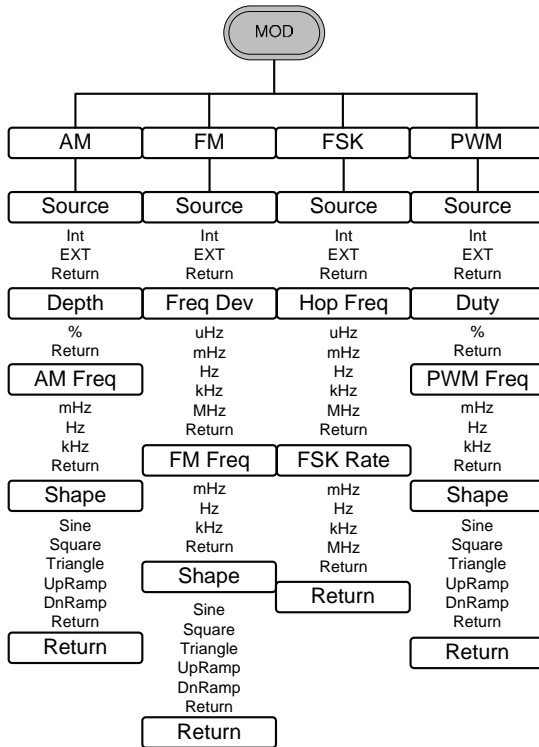

Sweep

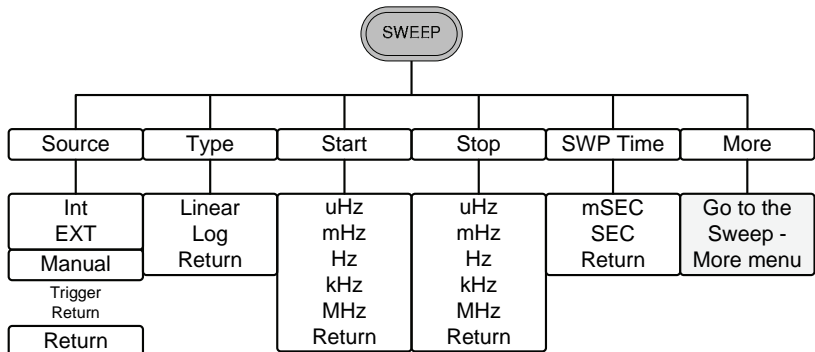

Sweep - More

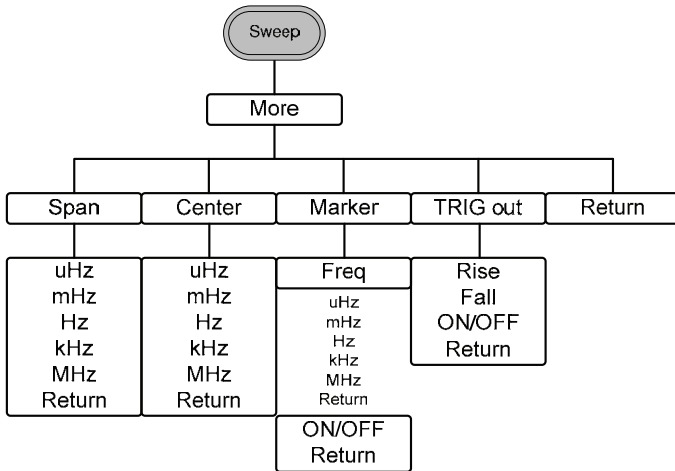

Burst – N Cycle

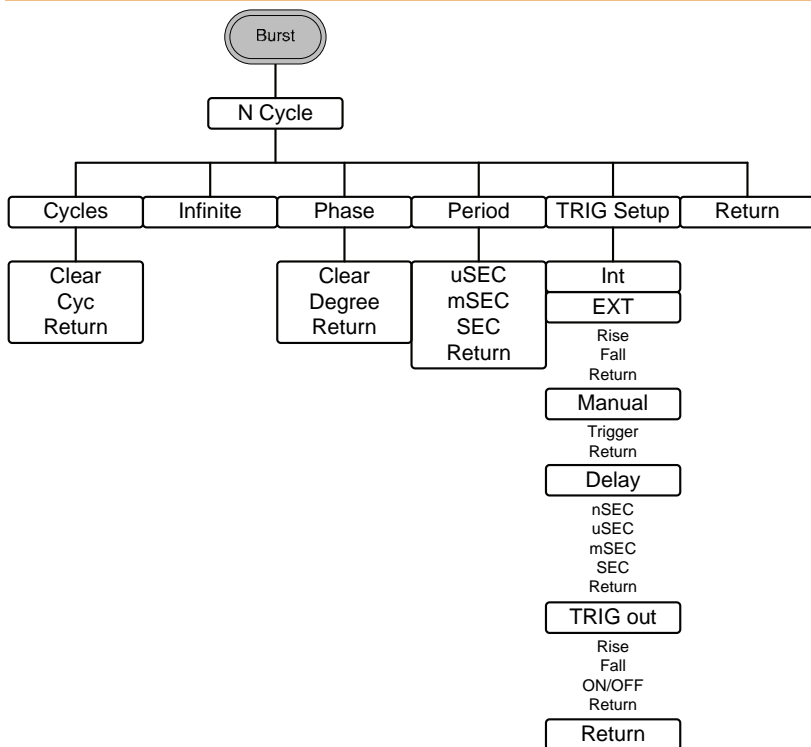

Burst - Gate

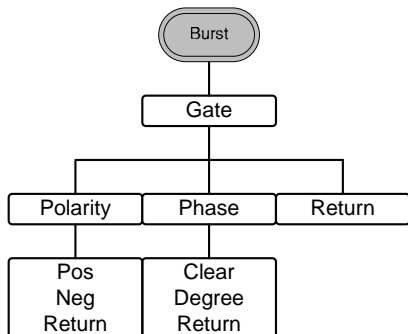

UTIL

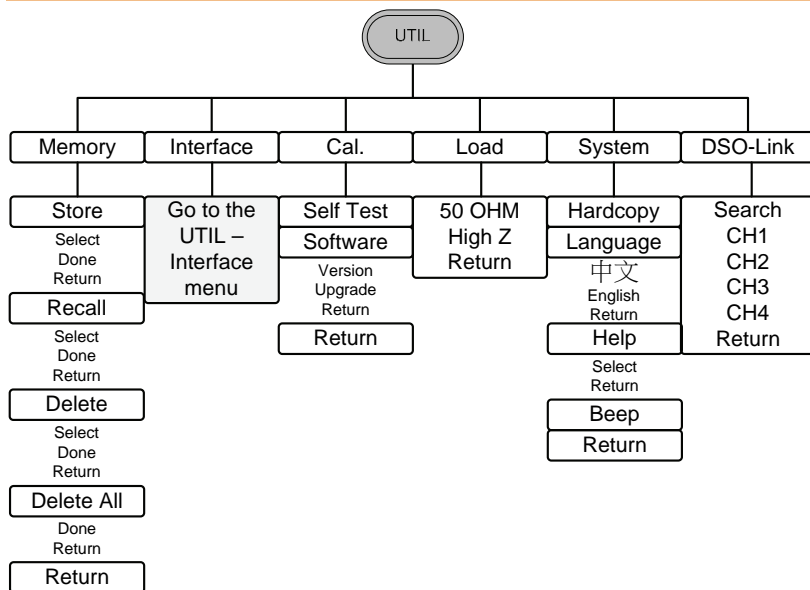

UTIL - Interface

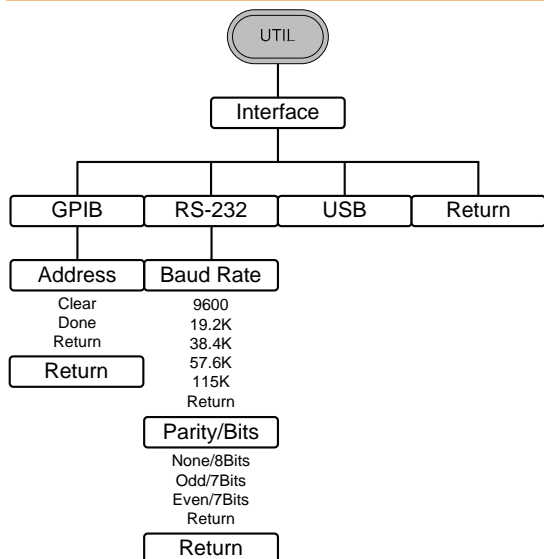

Default Settings

Here are the default panel settings which appear when pressing the Preset key.



Output Config.	Function	Sine wave
	Frequency	1kHz
	Amplitude	3.000 Vpp
	Offset	0.00V dc
	Output units	Vpp
	Output terminal	50Ω
Modulation (AM/FM/FSK)	Carrier Wave	1kHz Sine wave
	Modulation waveforms	100Hz Sine wave
	AM Depth	100%
	FM Deviation	100Hz
	FSK Hop Frequency	100Hz
	FSK Frequency	10Hz
	PWM Duty	50%
	PWM Frequency	20kHz
	Modem Status	Off
Sweep	Start/Stop frequency	100Hz/1kHz
	Sweep time	1s
	Sweep type	Linear
	Sweep status	Off

Burst	Burst Frequency	1kHz
	Ncycle	1
	Burst period	10ms
	Burst starting phase	0°
	Burst status	Off
System settings	Power off signal	On
	Display mode	On
	Error queue	cleared
	Memory settings	No change
	Output	Off
Trigger	Trigger source	Internal (immediate)
Interface config.	GPIB Address	10
	Interface	RS232
	Baud rate	115200
	Parity	None (8 data bits)
Calibration	Calibration Menu	Restricted

O PERATION

The Operation chapter shows how to output basic waveform functions. For details on modulation, sweep, burst and arbitrary waveforms, please see the Modulation and Arbitrary waveform chapters on pages 65 and 137.

Select a Waveform	56
Sine Wave	56
Setting a Square Wave	57
Triangle Wave	58
Setting the Pulse Width	59
Setting a Ramp	60
Noise Wave	61
Setting the Frequency	61
Setting the Amplitude	63
Setting the DC Offset	64

Select a Waveform

The AFG-3000 can output six standard waveforms: sine, square, triangle, pulse, ramp and noise waveforms.

Sine Wave



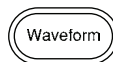

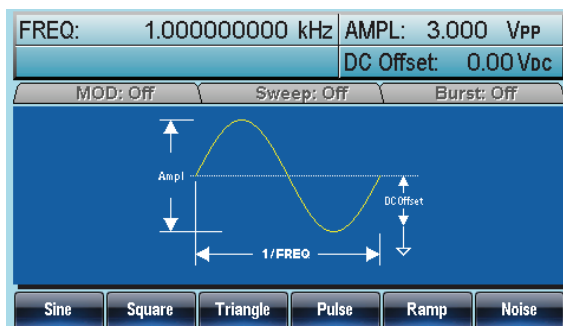

Panel Operation 1. Press the Waveform key.

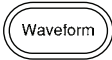

2. Press F1 (Sine).

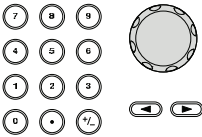

Setting a Square Wave

- Panel Operation
1. Press the Waveform key. 
 2. Press F2 (Square) to create a square waveform.  
 3. Press F1 (Duty). The Duty parameter will be highlighted in the parameter window.  
- | | |
|-----------------------|---------------------|
| FREQ: 1.000000000 kHz | AMPL: 3.000 Vpp |
| DUTY: 50.0% | DC Offset: 0.00 Vdc |
4. Use the selector keys and scroll wheel or number pad to enter the Duty range. 
 5. Press F5 (%) to choose % units.  

Range	Frequency	Duty Range
	≤25MHz	20%~80%
	25MHz~≤50MHz	40%~60%
	>50MHz~80MHz	50% (Fixed)

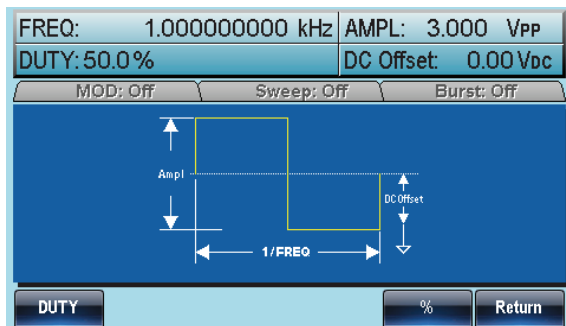

Triangle Wave

Panel Operation

1. Press the Waveform key.

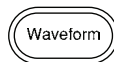

2. Press F3 (Triangle).

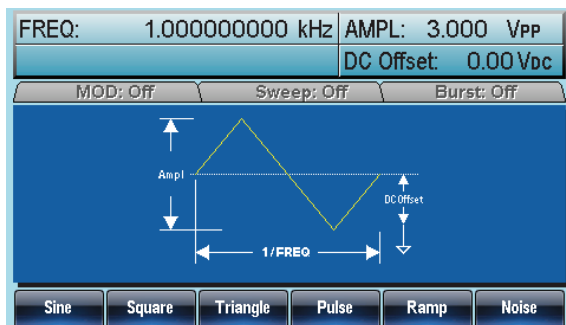

Setting the Pulse Width

Panel Operation

1. Press the Waveform key.



2. Press F4 (Pulse) to create a pulse waveform.



3. Press F1 (Width). The Width parameter will be highlighted in the parameter window.



FREQ:	1.000000000 kHz	AMPL:	3.000 Vpp
WIDTH:	50.000 uSec	DC Offset:	0.00 Vdc

4. Use the selector keys and scroll wheel or number pad to enter the pulse width.

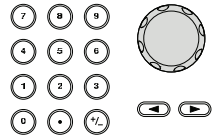

5. Press F2~F5 choose the unit range.



Range	Pulse Width	8ns~1999.9s
! Note	Minimum Pulse Width	Freq ≤ 50MHz: 8ns pulse width Freq ≤ 6.25 MHz: 5% duty cycle
	Resolution	Freq ≤ 50MHz: 1ns pulse width Freq ≤ 6.25 MHz: 1% duty cycle

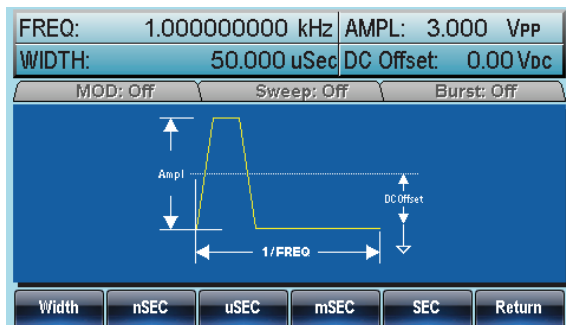

Setting a Ramp

Panel Operation

1. Press the Waveform key.

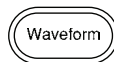

2. Press F5 (Ramp) to create a ramp waveform.



3. Press F1 (SYM). The SYMM parameter will be highlighted in the parameter window.

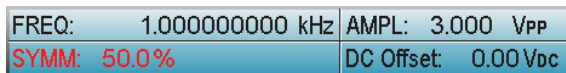

4. Use the selector keys and scroll wheel or number pad to enter the symmetry percentage.

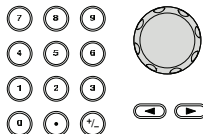

5. Press F5 (%) to choose % units.



Range

Symmetry

0%~100%

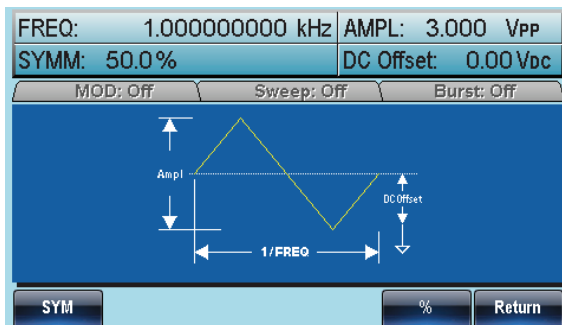

Noise Wave

Panel Operation 1. Press the Waveform key.

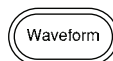

2. Press F6 (Noise).

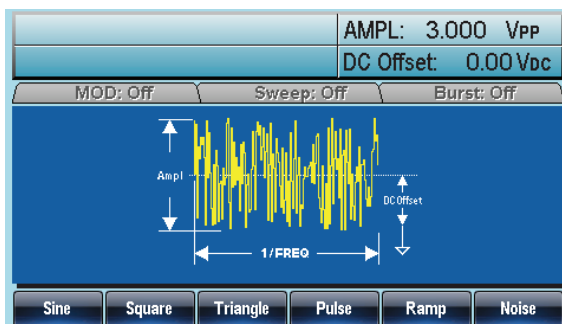

Setting the Frequency

Panel Operation 1. Press the FREQ/Rate key.



2. The FREQ parameter will become highlighted in the parameter window.

FREQ: 1.00000000 kHz	AMPL: 3.000 Vpp
DC Offset: 0.00 Vdc	

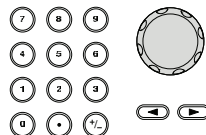
3. Use the selector keys and scroll wheel or number pad to enter the frequency.
- 

4. Choose a frequency unit by pressing F2~F6.
- 

Range	Sine	1μHz~80MHz(3081)/50MHz(3051)
	Square	1μHz~80MHz(3081)/50MHz(3051)
	Triangle	1μHz~1MHz
	Pulse	500μHz~50MHz
	Ramp	1μHz~1MHz

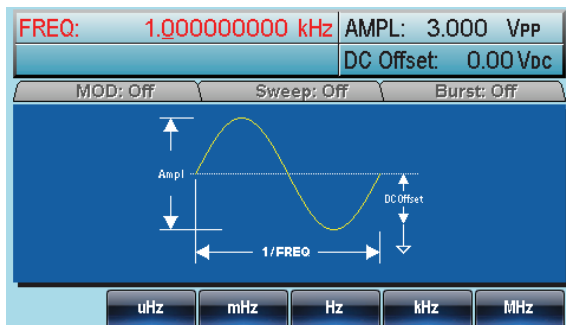

Setting the Amplitude

Panel Operation

1. Press the AMPL key.



2. The AMPL parameter will become highlighted in the parameter window.

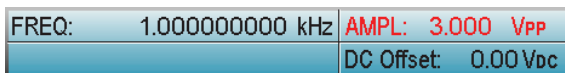

3. Use the selector keys and scroll wheel or number pad to enter the amplitude.

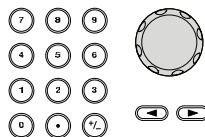

4. Choose a unit type by pressing F2~F6.



	50Ω load	High Z
Range	10mVpp~10Vpp	20mVpp~20Vpp
Unit	Vpp, Vrms, dBm	

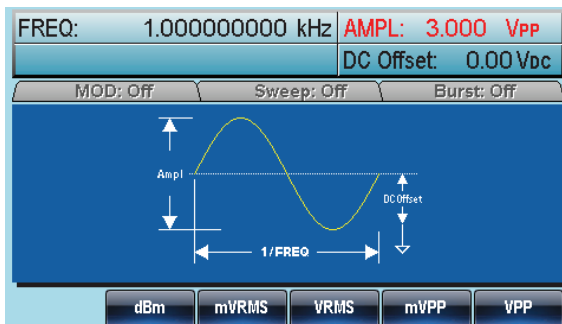

Setting the DC Offset

Panel Operation

1. Press the DC Offset key.

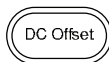

2. The DC Offset parameter will become highlighted in the parameter window.

FREQ:	1.000000000 kHz	AMPL:	3.000 Vpp
		DC Offset:	0.00 Vdc

3. Use the selector keys and scroll wheel or number pad to enter the DC Offset.

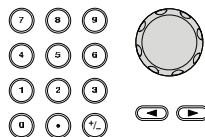

4. Press F5 (mVDC) or F6 (VDC) to choose a voltage range.



	50Ω load	High Z
Range	±5Vpk	±10Vpk

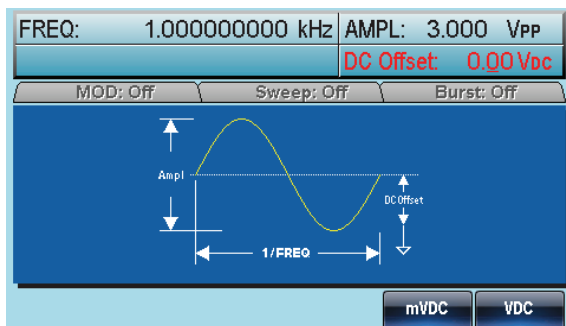

M MODULATION

The AFG-3000 Series Arbitrary Function Generators are able to produce AM, FM, FSK and PWM modulated waveforms. Depending on the type of waveform produced, different modulation parameters can be set. Only one modulation mode can be active at any one time. The function generator also will not allow sweep or burst mode to be used with AM/FM. Activating a modulation mode will turn the previous modulation mode off.

Amplitude Modulation (AM)	67
Selecting AM Modulation	68
AM Carrier Shape	68
Carrier Frequency	69
Modulating Wave Shape	70
AM Frequency	71
Modulation Depth	72
Selecting (AM) Modulation Source	73
Frequency Modulation (FM)	75
Selecting Frequency Modulation (FM)	76
FM Carrier Shape	76
FM Carrier Frequency	77
FM Wave Shape	78
Frequency Modulation Waveform	79
Frequency Deviation	80
Selecting (FM) Modulation Source	81
Frequency Shift Keying (FSK) Modulation	83
Selecting FSK Modulation	84
FSK Carrier Shape	84
FSK Carrier Frequency	85
FSK Hop Frequency	86
FSK Rate	87
FSK Source	88
Pulse Width Modulation	90
Selecting Pulse Width Modulation	91
PWM Carrier Shape	91
PWM Carrier Frequency	92

PWM Modulating Wave Shape.....	92
Modulating Waveform Frequency.....	93
Modulation Duty Cycle	94
PWM Source	95
Frequency Sweep	97
Selecting Sweep Mode.....	98
Setting Start and Stop Frequency.....	98
Center Frequency and Span.....	100
Sweep Mode.....	102
Sweep Time.....	103
Marker Frequency	104
Sweep Trigger Source	105
Trigger Output	106
Burst Mode	108
Selecting Burst Mode.....	109
Burst Modes.....	109
Burst Frequency	110
Burst Cycle/Burst Count	111
Infinite Burst Count	112
Burst Period	113
Burst Phase	115
Burst Trigger Source	116
Burst Delay.....	118
Burst Trigger Output	119

Amplitude Modulation (AM)

An AM waveform is produced from a carrier waveform and a modulating waveform. The amplitude of the modulated carrier waveform depends on the amplitude of the modulating waveform. The AFG-3000 function generator can set the carrier frequency, amplitude and offset as well as internal or external modulation sources.

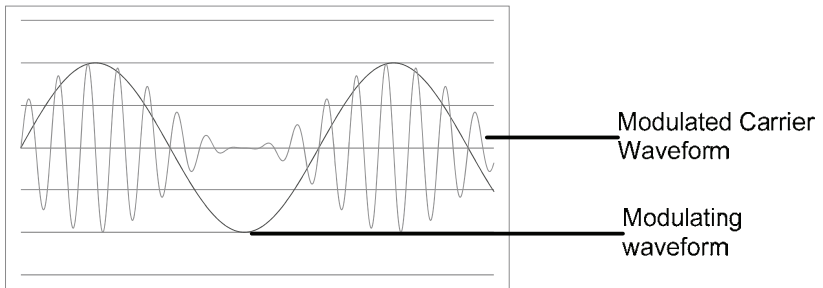

Selecting AM Modulation

Panel Operation 1. Press the MOD key.



2. Press F1 (AM).

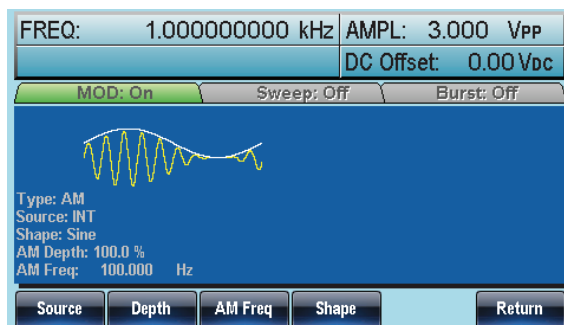

AM Carrier Shape

Background

The shape function selects the AM carrier waveform shape. Sine, square, triangle, ramp, pulse or arbitrary waveforms can be used as the carrier shape. The default waveform shape is set to sine. Noise is not available as a carrier shape. Before the carrier shape can be selected, choose AM modulation mode, see page 28 or 70.

Select a Standard Carrier Shape 1. Press the Waveform key.

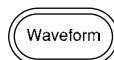

2. Press F1~F5 to choose the carrier wave shape.



Select an Arbitrary Waveform Carrier Shape.	3. See the Arbitrary waveform quick guide or chapter to use an arbitrary waveform.	Page 35 Page 137
---	--	---------------------

Range	AM Carrier Shape	sine, square, triangle, upramp, dn ramp, arbitrary waveform
-------	------------------	---

Carrier Frequency

The maximum carrier frequency depends on the carrier shape selected. The default carrier frequency for all carrier shapes is 1kHz.

- Panel Operation
- With a carrier waveform, press the **FREQ/Rate** key. 
 - The **FREQ** parameter will become highlighted in the parameter window.

FREQ: 1.00000000 kHz	AMPL: 3.000 Vpp
	DC Offset: 0.00 Vdc
 - Use the selector keys and scroll wheel or number pad to enter the carrier frequency.

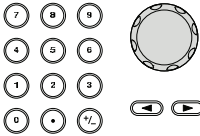
 - Press **F2~F6** to select the frequency range.

uHz

~

MHz

~











F2

F6

Range	Carrier Shape	Carrier Frequency
	Sine	1μHz~80MHz(3081)/ 50MHz(3051)
	Square	1μHz~80MHz(3081)/ 50MHz(3051)
	Triangle	1μHz~1MHz
	Pulse	500μHz~50MHz
	Ramp	1μHz~1MHz

Modulating Wave Shape

The function generator can accept internal as well as external sources. The AFG-3000 has sine, square, triangle, up ramp and down ramp modulating waveform shapes. Sine waves are the default wave shape.

- | | | |
|-----------------|--|--|
| Panel Operation | 1. Select MOD. |  |
| | 2. Press F1 (AM). |   |
| | 3. Press F4 (Shape). |   |
| | 4. Press F1~F5 to select the waveform shape. |  ~ 
  |
| | 5. Press F6 (Return) to return to the menu. |   |

Note	Square wave	50% Duty cycle
	UpRamp	100% Symmetry
	Triangle	50% Symmetry
	DnRamp	0% Symmetry

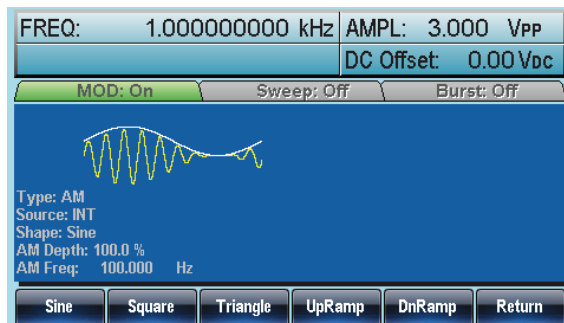

AM Frequency

The frequency of the modulation waveform (AM Frequency) can be set from 2mHz to 20kHz.

Panel Operation

1. Press the MOD key.



2. Press F1 (AM).



3. Press F3 (AM Freq).



4. The AM Freq parameter will become highlighted in the Waveform display area.

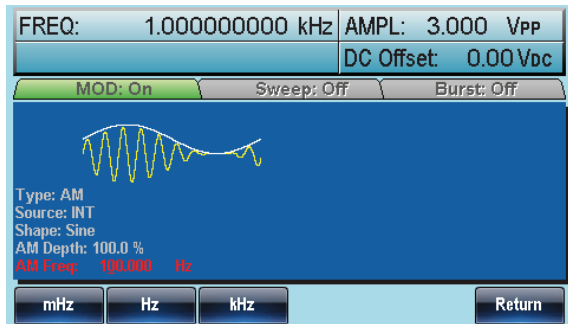

5. Use the selector keys and scroll wheel or number pad to enter the AM frequency.

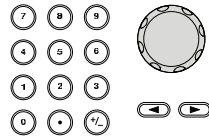

6. Press F1~F3 to select the frequency range.



Range

Modulation frequency 2mHz~20kHz

Default frequency 100Hz

Modulation Depth

Modulation depth is the ratio (as a percentage) of the unmodulated carrier amplitude and the minimum amplitude deviation of the modulated waveform. In other words, modulation depth is the maximum amplitude of the modulated waveform compared to the carrier waveform as a percentage.

Panel Operation

1. Press the MOD key.



2. Press F1 (AM).



3. Press F2 (Depth).



4. The AM Depth parameter will become highlighted in the waveform display area.

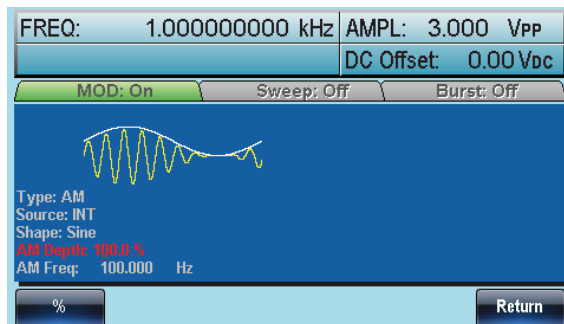

5. Use the selector keys and scroll wheel or number pad to enter the AM depth.

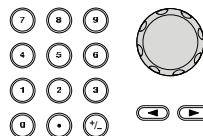

6. Press F1 (%) to choose % units. 





Range	Depth	0%~120%
	Default depth	100%

Note When the modulation depth is greater than 100%, the output cannot exceed $\pm 5V_{Peak}$ (10k Ω load).

If an external modulation source is selected, modulation depth is limited to $\pm 5V$ from the MOD INPUT terminal on the rear panel. For example, if modulation depth is set to 100%, then the maximum amplitude is +5V, and the minimum amplitude is -5V.

Selecting (AM) Modulation Source

The function generator will accept an internal or external source for AM modulation. The default source is internal.

- Panel Operation**
1. Press the MOD key. 
 2. Press F1 (AM). 
 3. Press F1 (Source). 
 4. To select the source, press F1 (Internal) or F2 (External). 
 5. Press F6 (Return) to return to the menu. 

External Source Use the MOD INPUT terminal on the rear panel when using an external source.

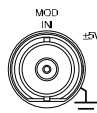

Note If an external modulation source is selected, modulation depth is limited to $\pm 5V$ from the MOD INPUT terminal on the rear panel. For example, if modulation depth is set to 100%, then the maximum amplitude is +5V, and the minimum amplitude is -5V.



Frequency Modulation (FM)

A FM waveform is produced from a carrier waveform and a modulating waveform. The instantaneous frequency of the carrier waveform varies with the magnitude of the modulating waveform. When using the AFG-3000 function generator, only one type of modulated waveform can be created at any one time.

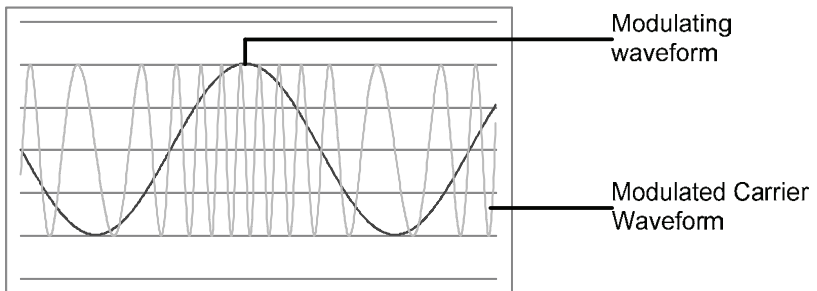

Selecting Frequency Modulation (FM)

When FM is selected, the modulated waveform depends on the carrier frequency, the output amplitude and offset voltage.

Panel Operation 1. Press the MOD key.



2. Press F2 (FM).

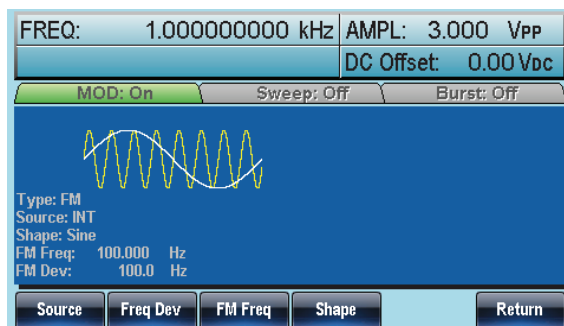

FM Carrier Shape

Background The Shape mode selects the FM carrier waveform shape. The default waveform shape is set to sine. Noise and Pulse waveforms cannot be used as a carrier wave.

Panel Operation 1. Press the Waveform key.

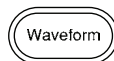

2. Press F1~F5 to choose the carrier wave shape. (bar F4)



Range	Carrier Shape	Sine, Square, Triangle, Ramp.
-------	---------------	-------------------------------

FM Carrier Frequency

When using the AFG-3000 function generator, the carrier frequency must be equal to or greater than the frequency deviation. If the frequency deviation is set to value greater than the carrier frequency, the deviation is set to the maximum allowed. The maximum frequency of the carrier wave depends on the waveform shape chosen.

- Panel Operation
- To select the carrier frequency, press the **FREQ/Rate** key. 

- The **FREQ** parameter will become highlighted in the parameter window.



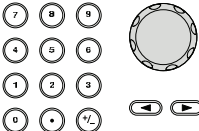









- Use the selector keys and scroll wheel or number pad to enter the carrier frequency. 

- Press **F2~F6** to select the frequency unit. 

Range	Carrier Shape	Carrier Frequency
	Sine	1 μ Hz~80MHz(3081)/50MHz(3051)
	Square	1 μ Hz~80MHz(3081)/50MHz(3051)
	Triangle	1 μ Hz~1MHz
	Ramp	1 μ Hz~1MHz
	Default frequency	1 kHz

FM Wave Shape

The function generator can accept internal as well as external sources. The AFG-3000 has sine, square, triangle, positive and negative ramps (UpRamp, DnRamp) as the internal modulating waveform shapes. Sine is the default wave shape.



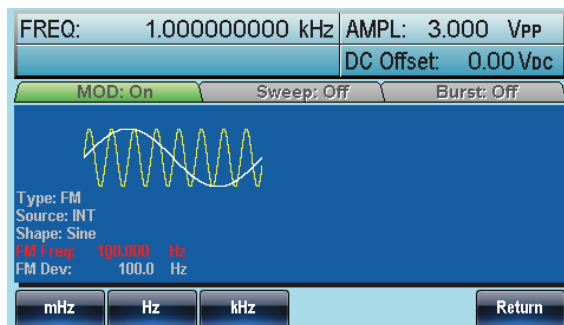

- | | | |
|-----------------|--|--|
| Panel Operation | 1. Select MOD. |  |
| | 2. Press F2 (FM). |   |
| | 3. Press F4 (Shape). |   |
| | 4. Press F1~F5 to select the waveform shape. |  ~ 
  |
| | 5. Press F6 (Return) to return to the menu. |   |

Note	Square wave	50% Duty cycle
	UpRamp	100% Symmetry
	Triangle	50% Symmetry
	DnRamp	0% Symmetry





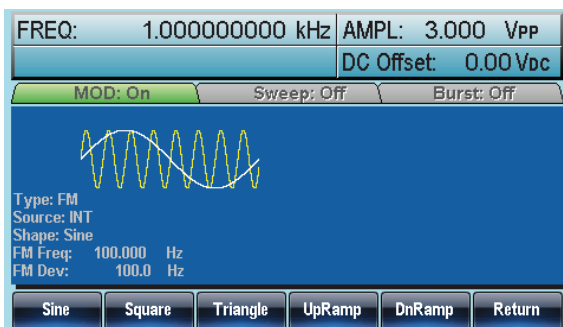

Frequency Modulation Waveform

For frequency modulation, the function generator will accept internal or external sources.

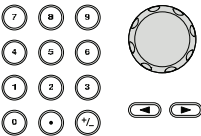
- Panel Operation
1. Press the MOD key. 
 2. Press F2 (FM).  
 3. Press F3 (FM Freq).  
 4. The FM Freq parameter will become highlighted in waveform display panel.



5. Use the selector keys and scroll wheel or number pad to enter the FM frequency. 
6. Press F1~F3 to select the frequency unit.    

Range	Modulation frequency	2mHz~20kHz
	Default frequency	100Hz

Frequency Deviation

The frequency deviation is the peak frequency deviation from the carrier wave and the modulated wave.

Panel Operation 1. Press the MOD key.



2. Press F2 (FM).



3. Press F2 (Freq Dev).



4. The Freq Dev parameter will become highlighted in the waveform display panel.

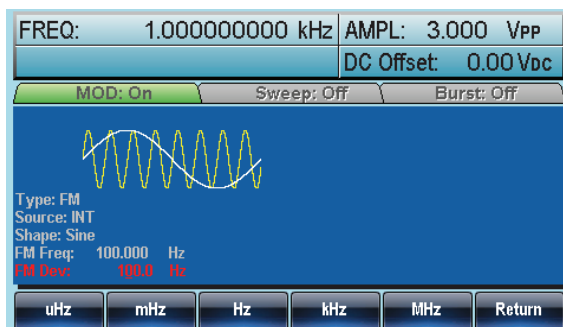

5. Use the selector keys and scroll wheel or number pad to enter the frequency deviation.

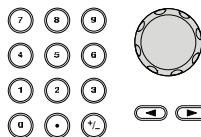





6. Press F1~ F5 to choose the frequency units.



Range	Frequency Deviation	DC~80MHz (3081) DC~50MHz (3051) DC~1MHz (Triangle)
	Default depth	100kHz

Selecting (FM) Modulation Source

The function generator will accept an internal or external source for FM modulation. The default source is internal.

- Panel Operation
1. Press the MOD key. 
 2. Press F2 (FM). 
 3. Press F1 (Source). 
 4. To select the source, press F1 (Internal) or F2 (External). 
 5. Press F6 (Return) to return to the menu. 

External Source Use the MOD INPUT terminal on the rear panel when using an external source.

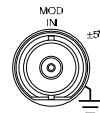

Note

If an external modulating source is selected, the frequency deviation is limited to the $\pm 5V$ MOD INPUT terminal on the rear panel. The frequency deviation is proportional to the signal level of the modulation in voltage. For example, if the modulation in voltage is +5V, then the frequency deviation would be equal to the set frequency deviation. Lower signal levels reduce the frequency deviation while negative voltage levels produce frequency deviations with frequencies below the carrier waveform.

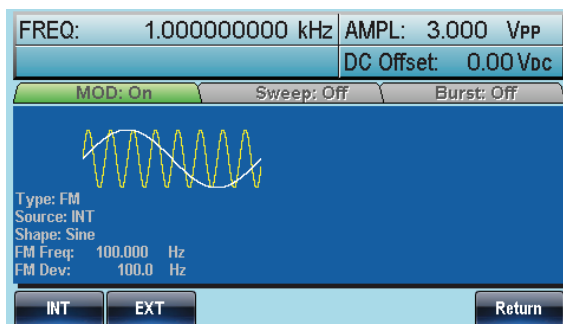

Frequency Shift Keying (FSK) Modulation

Frequency Shift Keying Modulation is used to shift the frequency output of the function generator between two preset frequencies (carrier frequency, hop frequency). The frequency at which the carrier and hop frequency shift is determined by the internal rate generator or the voltage level from the Trigger INPUT terminal on the rear panel.

Only one modulation mode can be used at once. When FSK modulation is enabled, any other modulation modes will be disabled. Sweep and Burst also cannot be used with FSK modulation. Enabling FSK will disable Sweep or Burst mode.

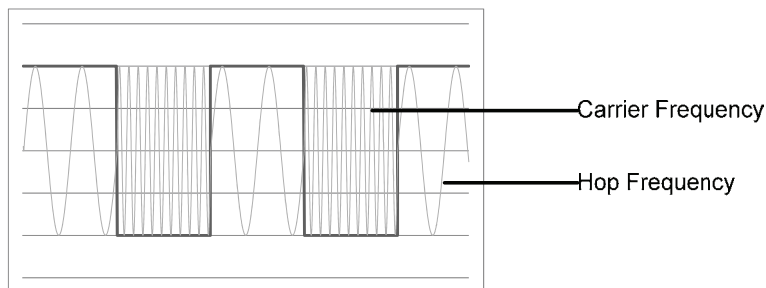

Selecting FSK Modulation

When using FSK mode, the output waveform uses the default settings for carrier frequency, amplitude and offset voltage.

Panel Operation 1. Press the MOD key.



2. Press F3 (FSK).

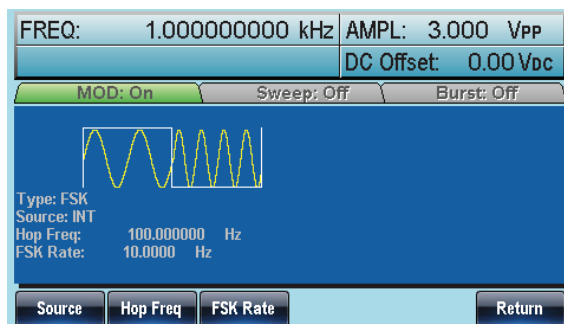

FSK Carrier Shape

Background The shape function selects the FSK carrier waveform shape. The default waveform shape is set to sine. Noise waveforms cannot be used as carrier waves.

Panel Operation 1. Press the Waveform key.

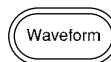

2. Press F1~F5 to choose the carrier wave shape. (bar F4)



Range

Carrier Shape

Sine, Square, Triangle, Ramp, Pulse



FSK Carrier Frequency

The maximum carrier frequency depends on the carrier shape. The default carrier frequency for all carrier shapes is 1kHz. The voltage level of the Trigger INPUT signal controls the output frequency when EXT is selected. When the Trigger INPUT signal is logically low the carrier frequency is output and when the signal is logically high, the hop frequency is output.

Panel Operation

- To select the carrier frequency, press the **FREQ/Rate** key.
 
- The **FREQ** parameter will become highlighted in the parameter window.

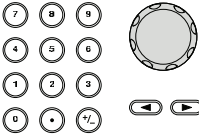

- Use the selector keys and scroll wheel or number pad to enter the carrier frequency.
 
- Press **F2~F6** to select the FSK frequency units.
 

Range	Carrier Shape	Carrier Frequency
	Sine	1 μ Hz~80MHz(3081)/ 50MHz(3051)
	Square	1 μ Hz~80MHz(3081)/ 50MHz(3051)
	Triangle	1 μ Hz~1MHz
	Ramp	1 μ Hz~1MHz
	Pulse	500 μ Hz~50MHz

FSK Hop Frequency

The default Hop frequency for all waveform shapes is 100 Hz. A square wave with a duty cycle of 50% is used for the internal modulation waveform. The voltage level of the Trigger INPUT signal controls the output frequency when EXT is selected. When the Trigger INPUT signal is logically low the carrier frequency is output and when the signal is logically high, the hop frequency is output.

Panel Operation

1. Press the MOD key.



2. Press F3 (FSK).



3. Press F2 (Hop Freq).



4. The Hop Freq parameter will become highlighted in the Waveform Display area.

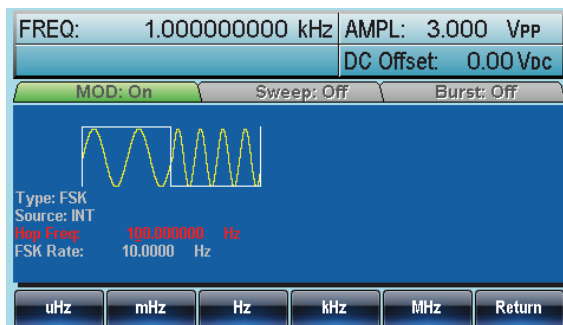

5. Use the selector keys and scroll wheel or number pad to enter the hop frequency.

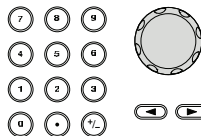

6. Press F1~F5 to select the frequency range.



Range	Waveform	Carrier Frequency
	Sine	1μHz~80MHz(3081)/ 50MHz(3051)
	Square	1μHz~80MHz(3081)/ 50MHz(3051)
	Triangle	1μHz~1MHz
	Ramp	1μHz~1MHz
	Pulse	500μHz~50MHz

FSK Rate.

FSK Rate function is used to determine rate at which the output frequency changes between the carrier and hop frequencies. The FSK Rate function only applies to internal FSK sources.

Panel Operation

1. Select MOD.



2. Press F3 (FSK).



3. Press F3 (FSK Rate).



4. The FSK Rate parameter will become highlighted in the waveform display area.

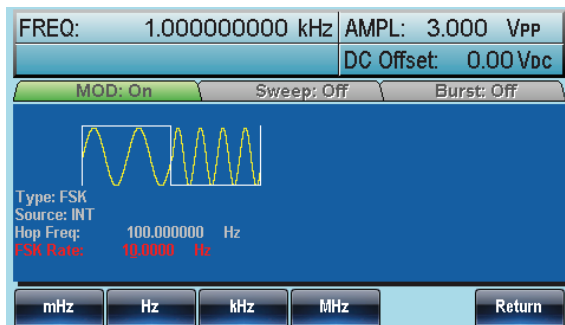

5. Use the selector keys and scroll wheel or number pad to enter the FSK rate.

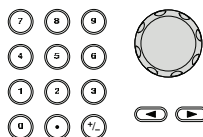

6. Press F1~F5 to select the frequency unit.



Range	FSK Rate	2mHz~100kHz
	Default	10Hz

Note If an external source is selected, FSK Rate settings are ignored.

FSK Source

The AFG-3000 accepts internal and external FSK sources, with internal as the default source. When the FSK source is set to internal, the FSK rate is configured using the FSK Rate function. When an external source is selected the FSK rate is equal to the frequency of the Trigger INPUT signal on the rear panel.

- Panel Operation 1. Press the MOD key.



2. Press F3 (FSK).



3. Press F1 (Source).



4. To select the source, press F1 (Internal) or F2 (External).



5. Press F6 (Return) to return to the menu.



Note

Note that the Trigger INPUT terminal cannot configure edge polarity.

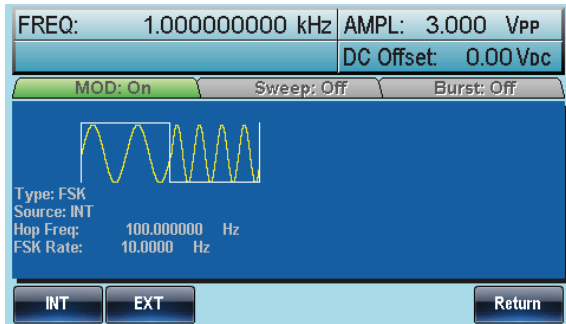





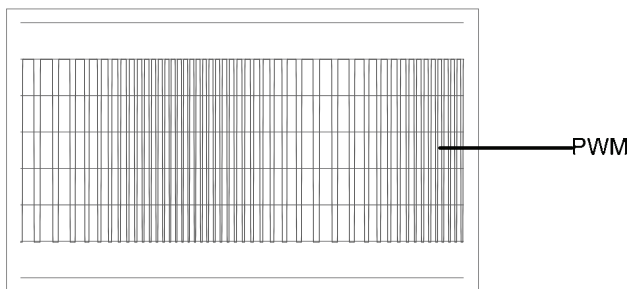

Pulse Width Modulation

For pulse width modulation the instantaneous voltage of the modulating waveform determines the width of the pulse waveform. Only one mode of modulation can be enabled at any one time. If PWM is enabled, any other modulation mode will be disabled. Likewise, burst and sweep modes cannot be used with PWM and will be disabled when PWM is enabled.

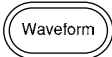

Selecting Pulse Width Modulation

When selecting PWM, the current setting of the carrier frequency, the amplitude modulation frequency, output, and offset voltage must be considered.

- Panel Operation
1. Press the MOD key. 
 2. Press F2 (Square).  
 3. Press the MOD key. 
 4. Press F4 (PWM).  



PWM Carrier Shape

PWM uses a square wave as the carrier shape. Other wave shapes cannot be used with PWM. If a carrier shape other than square is used with PWM, an error message will appear.

PWM Carrier Frequency

The carrier frequency depends on the square wave. The default carrier frequency is 1kHz.

Panel Operation

- To select the carrier frequency, press the **FREQ/Rate** key.



- The **FREQ** parameter will become highlighted in the parameter window.

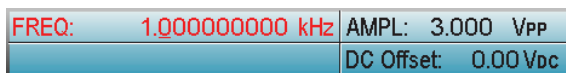

- Use the selector keys and scroll wheel or number pad to enter the carrier frequency.

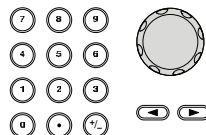

- Press **F2~F6** to select the PWM frequency unit.



PWM Modulating Wave Shape

The modulating wave shapes for internal sources include sine, square, triangle, up ramp and down ramp. The default wave shape is sine.

Panel Operation

- Press the **MOD** key.







- Press **F4 (PWM)**.





- Press **F4 (Shape)**.



4. Press F1~F5 to select a waveform shape.

 ~ 
 
5. Press F6 (Return) to return to the menu.

 

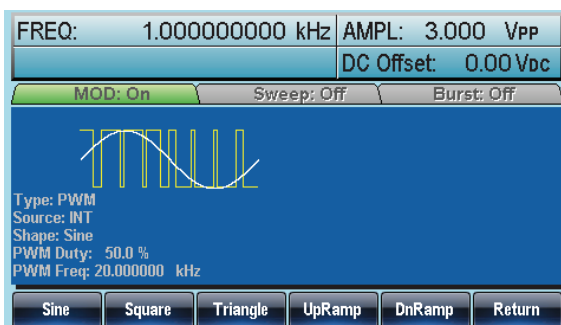

Range	Waveform	
	Square	50% Duty cycle
	UpRamp	100% Symmetry
	Triangle	50% Symmetry
	DnRamp	0% Symmetry





Modulating Waveform Frequency

- Panel Operation
1. Select MOD.

 2. Press F4 (PWM).

 
 3. Press F3 (PWM Frequency).

 
 4. The PWM Freq parameter will become highlighted in the Waveform Display area.

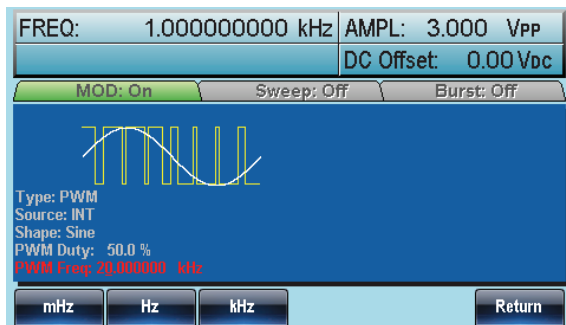

5. Use the selector keys and scroll wheel or number pad to enter the PWM frequency.
-

6. Press F1~F3 to select the frequency unit range.
-

Range	PWM Frequency	2mHz~20kHz
	Default	20kHz

Modulation Duty Cycle

Duty function is used to set the duty cycle as percentage.

- Panel Operation
1. Press the MOD key.
 2. Press F4 (PWM).
 3. Press F2 (Duty).
 4. The Duty parameter will become highlighted in the waveform display area.



5. Use the selector keys and scroll wheel or number pad to enter the Duty cycle.

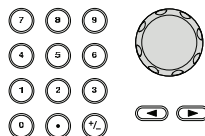

6. Press F1 (%) to select percentage units.



Range	Duty cycle	0% ~ 100%
	Default	50%

Note Pulse waveforms can be modulated with an external source using the external source function. When using an external source the pulse width is controlled by the $\pm 5V$ MOD INPUT terminal.

PWM Source

The AFG-3000 accepts internal and external PWM sources. Internal is the default source for PWM sources.

- Panel Operation** 1. Press the MOD key.



2. Press F4 (PWM).



3. Press F1 (Source).



4. To select the source, press F1 (Internal) or F2 (External).



5. Press F6 (Return) to return to the menu.



External Source

Use the MOD INPUT terminal on the rear panel when using an external source.

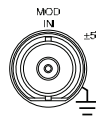

Note

If an external modulation source is selected, pulse width modulation is controlled by the $\pm 5V$ from the MOD INPUT terminal on the rear panel. For example, if modulation depth is set to 100%, then the maximum pulse width occurs at +5V, and the minimum pulse width at -5V.

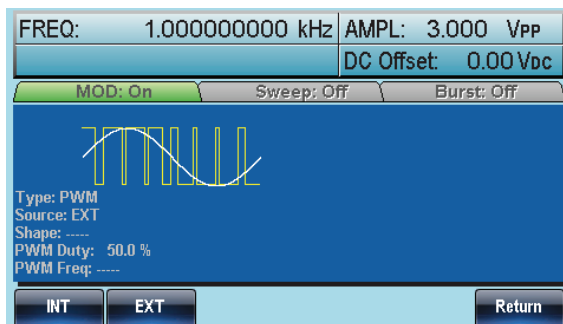

Frequency Sweep

The function generator can perform a sweep for sine, square or ramp waveforms, but not noise, and pulse. When Sweep mode is enabled, Burst or any other modulation modes will be disabled. When sweep is enabled, burst mode is automatically disabled.

In Sweep mode the function generator will sweep from a start frequency to a stop frequency over a number of designated steps. If manual or external sources are used, the function generator can be used to output a single sweep. The step spacing of the sweep can linear or logarithmic. The function generator can also sweep up or sweep down in frequency.

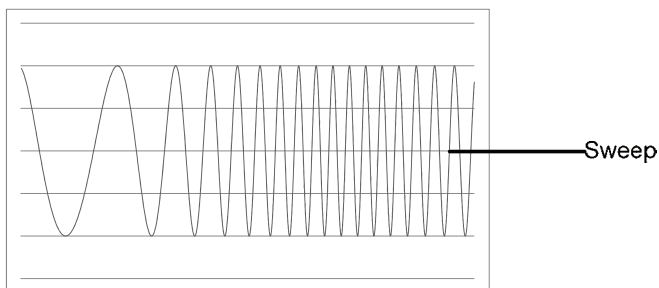

Selecting Sweep Mode

The Sweep button is used to output a sweep. If no settings have been configured, the default settings for output amplitude, offset and frequency are used.

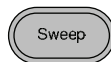

Setting Start and Stop Frequency

The start and stop frequencies define the upper and lower sweep limits. The function generator will sweep from the start through to the stop frequency and cycle back to the start frequency. The sweep is phase continuous over the full range sweep range (100µHz-80MHz: AFG-3081/50MHz: AFG-3051).

Panel Operation

1. Press the SWEEP key.



2. To select the start or stop frequency, press F3 (Start) or F4 (Stop).



3. The Start or Stop parameter will become highlighted in the waveform display area.

Start

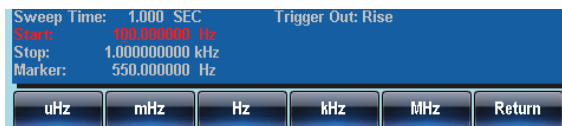

Stop

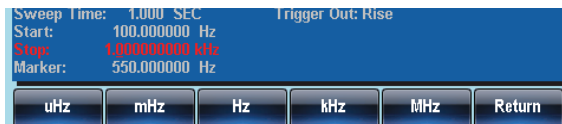

4. Use the selector keys and scroll wheel or number pad to enter the Stop/Start frequency.

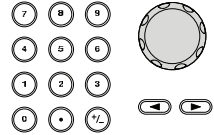

5. Press F1~F5 to select the Start/Stop frequency units.



Range	Sweep Range	100μHz~80MHz(3081) 100μHz~50MHz(3051) (Sine/Square) 100μHz~1MHz (Triangle)
	Start - Default	100Hz
	Stop - Default	1kHz

Note

To sweep from low to high frequencies, set the start frequency less than the stop frequency.

To sweep from high to low frequencies, set the start frequency greater than the stop frequency.

When marker is off, the SYNC signal is a square wave with a duty cycle of 50%. At the start of the sweep, the SYNC signal is at a TTL low level that rises to a TTL high level at the frequency midpoint. The frequency of the SYNC signal is equal to the sweep time.

When marker is on, at the start of the sweep, the SYNC signal is at a TTL high level that drops to a TTL low level at the marker. The SYNC signal is output from the mark output terminal.

Center Frequency and Span

A center frequency and span can be set to determine the upper and lower sweep limits (start/stop).

Panel Operation

1. Press the SWEEP key.



2. Press F6 (More).



3. To select span or center, press F1 (Span) or F2 (Center).



4. The Span or Center parameter will become highlighted in the Waveform Display area.

Span

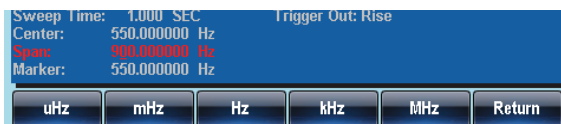

Center

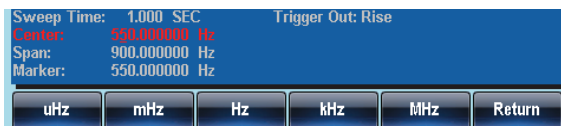

5. Use the selector keys and scroll wheel or number pad to enter the Span/Center frequency.

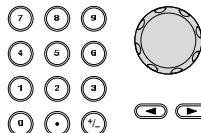

6. Press F1~F5 to select the Start/Stop frequency units.



Range	Center Frequencies	100μHz~80MHz(3081) 100μHz~50MHz(3051) (Sine/Square) 100μHz~1MHz (Triangle)
	Span Frequency	DC~80MHz(3081) DC~50MHz(3051) (Sine/Square) DC ~1MHz (Triangle)
	Center - Default	550Hz
	Span – Default	900Hz

Note

To sweep from low to high frequencies, set a positive span.

To sweep from high to low frequencies, set a negative span.

When marker is off, the SYNC signal is a square wave with a duty cycle of 50%. At the start of the sweep, the SYNC signal is at a TTL low level that rises to a TTL high level at the frequency midpoint. The frequency of the SYNC signal is equal to the sweep time.

When marker is on, at the start of the sweep, the SYNC signal is at a TTL high level that drops to a TTL low level at the marker. The SYNC signal is output from the mark output terminal.

Sweep Mode

Sweep mode is used to select between linear or logarithmic sweeping. Linear sweeping is the default setting.

Panel Operation

1. Press the SWEEP key.

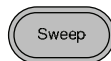

2. Press F2 (Type).



3. To select linear or logarithmic sweep, press F1 (Linear) or F2 (Log).



4. Press F6 (Return) to return to the menu.

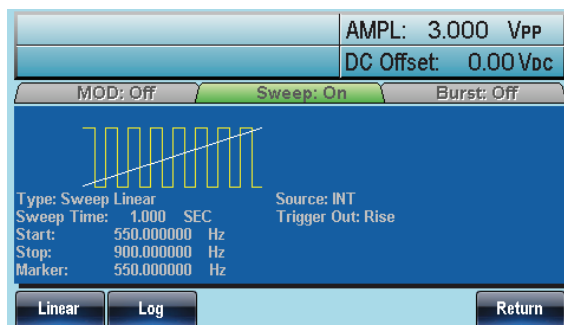

Sweep Time

The sweep time is used to determine how long it takes to perform a sweep from the start to stop frequencies. The function generator automatically determines the number of discrete frequencies used in the scan depending on the length of the scan.

Panel Operation

1. Press the SWEEP key.



2. Press F5 (SWP Time).



3. The Sweep Time parameter will become highlighted in the Waveform display area.

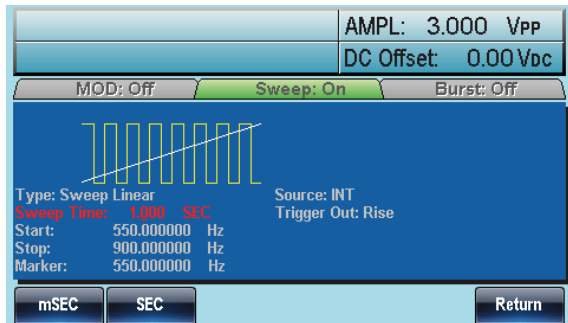

4. Use the selector keys and scroll wheel or number pad to enter the Sweep time.

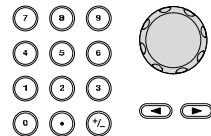

5. Press F1~F2 to select the time unit.









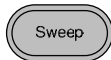

Range	Sweep time	1ms ~ 500s
	Default	1s

Marker Frequency

The marker frequency is the frequency at which the marker signal goes low (The marker signal is high at the start of each sweep). The marker signal is output from the MARK terminal on the rear panel. The default is 550 Hz.

Panel Operation

1. Press the SWEEP key. 
2. Press F6 (More).  
3. Press F3 (Marker).  
4. Press F2 (ON/OFF) to toggle the Marker  
5. Press F1 (Freq) to select the marker frequency.  
6. The Freq parameter will become highlighted in the Waveform Display area.

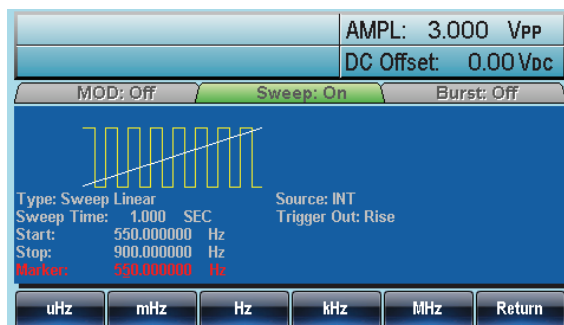

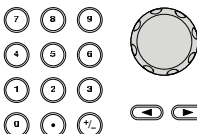
7. Use the selector keys and scroll wheel or number pad to enter the frequency. 

8. Press F1~F5 to select the frequency unit.



Range	Frequency	100μHz~80MHz(3081)
		100μHz~50MHz(3051)
		100μHz~1MHz (Ramp)
	Default	550Hz

Note The marker frequency must be set to a value between the start and stop frequencies. If no value is set, the marker frequency is set to the average of the start and stop frequencies.

Marker mode will override SYNC mode settings when sweep mode is active.

Sweep Trigger Source

In sweep mode the function generator will sweep each time a trigger signal is received. After a sweep output has completed, the function generator outputs the start frequency and waits for a trigger signal before completing the sweep. The default trigger source is internal.

Panel Operation 1. Press the SWEEP key.

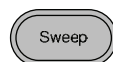

2. Press F1 (Source).





3. To select the source, press F1 (Internal), F2 (External) or F3 (Manual).



4. Press F6 (Return) to return to the menu.





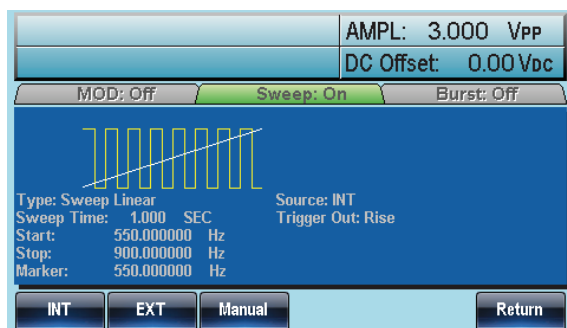

Note Using the Internal source will produce a continuous sweep using the sweep time settings. With an external source, a sweep is output each time a trigger pulse (TTL) is received from the Trigger INPUT terminal on the rear panel. The trigger period must be equal to or greater than the sweep time plus 1ms.

- If manual is selected, press   (F1 (Trigger)) to manually start each sweep.



Trigger Output

For sweep and burst mode, a trigger out signal can be output from the Trig Out terminal on the rear panel. By default the trigger out signal will output a rising edge TTL square wave at the beginning of a sweep. The signal can also be set to falling edge.

- Panel Operation**
- Press the SWEEP key. 
 - Press F6 (More).  
 - Press F4 (TRIG out).  

4. Press F3 (ON/OFF).



5. To choose the trigger edge, press F1 (Rise) or F2 (Fall).



Note

When an internal trigger source is selected, a square wave with a 50% duty cycle is output at the beginning of each sweep from the Trig out terminal. The waveform frequency is equal to the sweep time.

Using an external trigger source will disable the trig out signal.

When the manual trigger is selected, a >1us pulse is output from the trig out terminal at the start of each sweep or burst.

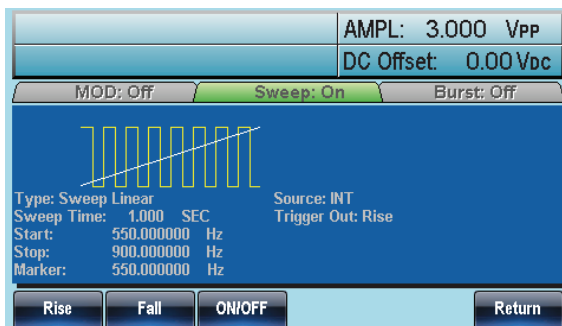

Burst Mode

The function generator can create a waveform burst with a designated number of cycles. Burst mode supports sine, square, triangle and ramp waveforms.

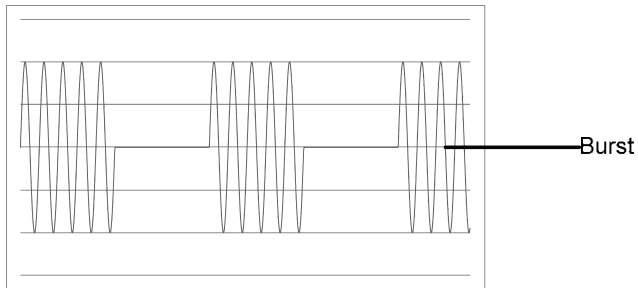

Selecting Burst Mode

When burst mode is selected, any modulation or sweep modes will be automatically disabled. If no settings have been configured, the default settings for output amplitude, offset and frequency are used.



Burst Modes

Burst mode can be configured using Triggered (N Cycle mode) or Gated mode. Using N Cycle/Triggered mode, each time the function generator receives a trigger, the function generator will output a specified number of waveform cycles (burst). After the burst, the function generator will wait for the next trigger before outputting another burst. N Cycle is the default Burst mode. Triggered mode can use internal or external triggers.

The alternative to using a specified number of cycles, Gate mode uses the external trigger to turn on or off the output. When the Trigger INPUT signal is high, waveforms are continuously output. When the Trigger INPUT signal goes low, the waveforms will stop being output after the last waveform completes its period. The voltage level of the output will remain equal to the starting phase of the burst waveforms, ready for the signal to go high again.

Burst Mode	Burst Count	Burst Period	Phase	Trigger Source
Triggered (Int)	Available	Available	Available	Immediate
Triggered (Ext)	Available	Unused	Available	EXT, Bus
Gated pulse (Ext)	Unused	Unused	Available	Unused

In Gated mode, burst count, burst cycle and trigger source are ignored. If a trigger is input, then the trigger will be ignored and will not generate any errors.

Panel Operation

1. Press the Burst key.



2. Select either N Cycle (F1) or Gate (F2).



Burst Frequency

In the N Cycle and Gated modes, the waveform frequency sets the repetition rate of the burst waveforms. In N-Cycle mode, the burst is output at the waveform frequency for the number of cycles set. In Gated mode the waveform frequency is output while the trigger is high. Burst mode supports sine, square, triangle or ramp waveforms.

Panel Operation

1. Press the FREQ/Rate key.



2. The FREQ parameter will become highlighted in the parameter window.



3. Use the selector keys and scroll wheel or number pad to enter the frequency.

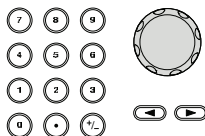

4. Press F2~F6 to choose the frequency unit.







Range	Frequency	2mHz~80MHz(3081)/ 50MHz(3051)
-------	-----------	----------------------------------

Frequency – Ramp	2mHz~1MHz
Default	1kHz

Note Waveform frequency and burst period are not the same. The burst period is the time between the bursts in N-Cycle mode.

Burst Cycle/Burst Count

The burst cycle (burst count) is used to define the number of cycles that are output for a burst waveform. Burst cycle is only used with N-cycle mode (internal, external or manual source). The default burst cycle is 1.

- Panel Operation**
1. Press the Burst key. 
 2. Press F1 (N Cycle).  
 3. Press F1 (Cycles).  
 4. The Cycles parameter will become highlighted in the Waveform Display area.

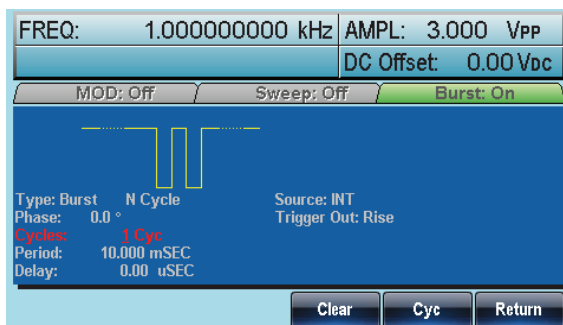

5. Use the selector keys and scroll wheel or number pad to enter the number of cycles.

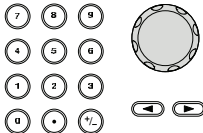

6. Press F5 to select the Cyc unit.



Range	Cycles	1~1,000,000
-------	--------	-------------

Note Burst cycles are continuously output when the internal trigger is selected. The burst period determines the rate of bursts and the time between bursts.

Burst cycle must be less than the product of the burst period and wave frequency.

$$\text{Burst Cycle} < (\text{Burst Period} \times \text{Wave Frequency})$$

If the burst cycle exceeds the above conditions, the burst period will be automatically increased to satisfy the above conditions.

If gated burst mode is selected, burst cycle is ignored. Though, if the burst cycle is changed remotely whilst in gated mode, the new burst cycle is remembered when used next.

Infinite Burst Count

Panel Operation 1. Press the Burst key.



2. Press F1 (N Cycle).



3. Press F2 (Infinite).



Note Infinite burst is only available when using manual triggering.

Above 25MHz, Infinite burst is only available with square and sine waveforms.

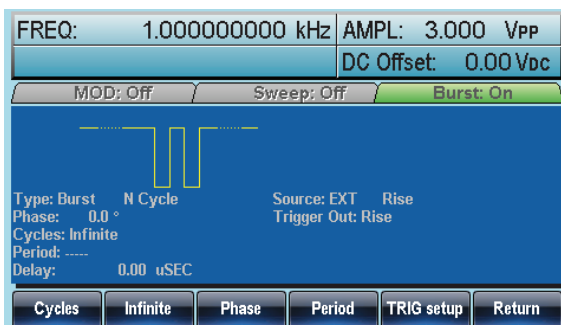

Burst Period

The burst period is used to determine the time between the start of one burst and the start of the next burst. It is only used for internally triggered bursts.

Panel Operation

1. Press the Burst key.



2. Press F1 (N Cycle).



3. Press F4 (Period).



4. The Period parameter will become highlighted in the Waveform Display area.

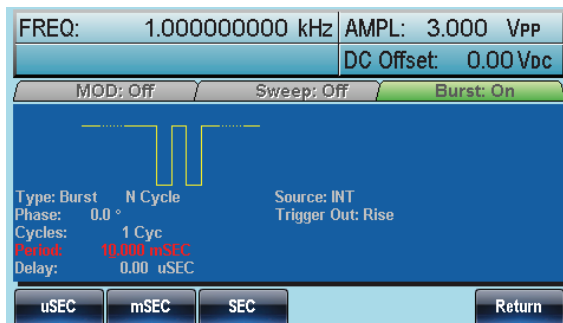

5. Use the selector keys and scroll wheel or number pad to enter period time.

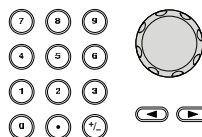

6. Press F1~F3 to choose the period time unit.



Range	Period time	1ms~500s
	Default	10ms

Note

Burst period is only applicable for internal triggers. Burst period settings are ignored when using gated burst mode or for external and manual triggers.

The burst period must be large enough to satisfied the condition below:

Burst Period > Burst Count / Wave frequency + 200ns.

Burst Phase

Burst Phase defines the starting phase of the burst waveform. The default is 0°.

Panel Operation

1. Press the Burst key.



2. Press F1 (N Cycle).



3. Press F3 (Phase).



4. The Phase parameter will become highlighted in the Waveform Display area.

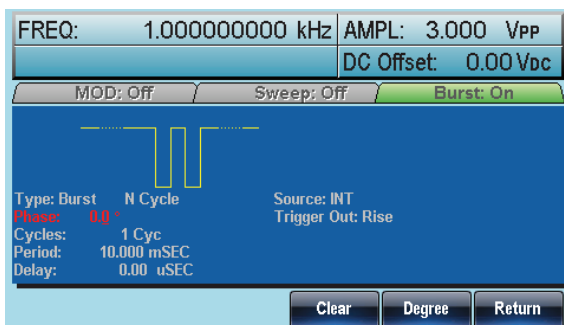

5. Use the selector keys and scroll wheel or number pad to enter the phase.

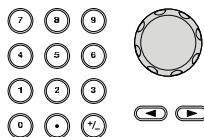

6. Press F5 (Degree) to select the phase unit.



Range	Phase	-360° ~ +360°
	Default	0°





Note When using sine, square, triangle or ramp waveforms, 0° is the point where the waveforms are at zero volts.

0° is the starting point of a waveform. For sine, square or Triangle, Ramp waveforms, 0° is at 0 volts (assuming there is no DC offset).

Burst Phase is used for both N cycle and Gated burst modes. In gated burst mode, when the Trigger INPUT signal goes low the output is stopped after the current waveform is finished. The voltage output level will remain equal to the voltage at the starting burst phase.

Burst Trigger Source

Each time the function generator receives a trigger in triggered burst (N-Cycle) mode, a waveform burst is output. The number of waveforms in each burst is designated by the burst cycle (burst count). When a burst has completed, the function generator waits for the next trigger. Internal source is the default triggered burst (N-cycle) mode on power up.

Panel Operation	<ol style="list-style-type: none"> 1. Press the Burst key. 	
	<ol style="list-style-type: none"> 2. Press F1 (N Cycle). 	
	<ol style="list-style-type: none"> 3. Press F5 (TRIG setup). 	
	<ol style="list-style-type: none"> 4. Choose a trigger type by pressing F1 (INT), F2 (EXT) or F3 (Manual). 	

Manual Triggering

If a manual source is selected, the trigger softkey (F1) must be pressed each time to output a burst.

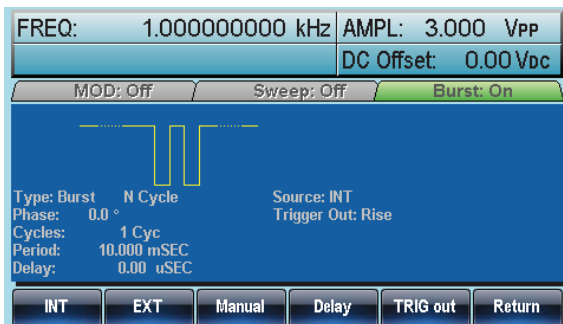

Note

When the internal trigger source is chosen, the burst is output continuously at a rate defined by the burst period setting. The interval between bursts is defined by the burst period.

When the external trigger is selected the function generator will receive a trigger signal (TTL) from the Trigger INPUT terminal on the rear panel. Each time the trigger is received, a burst is output (with the defined number of cycles). If a trigger signal is received during a burst, it is ignored.

When using the manual or external trigger only the burst phase and burst cycle/count are applicable, the burst period is not used.

A time delay can be inserted after each trigger, before the start of a burst.

Burst Delay

Panel Operation

1. Press the Burst key.



2. Press F1 (N Cycle).



3. Press F5 (TRIG setup).



4. Press F4 (Delay).



5. The Delay parameter will become highlighted in the Waveform Display area.



6. Use the selector keys and scroll wheel or number pad to enter period time.

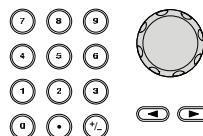











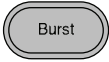

7. Press F1~F4 to choose the delay time unit.



Range	Delay time	0s~80s
	Default	0s

Burst Trigger Output

The Trig Out terminal on the rear panel can be used for burst or sweep modes to output a TTL compatible trigger signal. By default the trigger signal is rising edge. The trigger signal is output at the start of each burst.

Panel Operation	1. Press the Burst key.	
	2. Press F1 (N Cycle).	 
	3. Press F5 (TRIG setup).	 
	4. Press F5 (TRIG out).	 
	5. Press F3 (ON/OFF) to toggle Trigger out ON/OFF.	 
	6. Select F1 (Rise) or F2 (Fall) edge trigger.	   

Note When the internal trigger is selected, a square wave with a 50% duty cycle is output at the beginning of each burst.

Trig Out cannot be used with manual triggering and will be disabled if manual triggering is set. For manual triggering, a pulse is output (>1us) from the Trig Out connector at the start of each burst.

FREQ: 1.00000000 kHz		AMPL: 3.000 V _{PP}
		DC Offset: 0.00 V _{dc}
MOD: Off	Sweep: Off	Burst: On



Type: Burst N Cycle Source: INT
 Phase: 0.0 ° Trigger Out: Rise
 Cycles: 1 Cyc
 Period: 10.000 mSEC
 Delay: 0.00 uSEC

Rise	Fall	ON/OFF	Return
------	------	--------	--------

S ECONDARY SYSTEM FUNCTION SETTINGS

The secondary system functions are used to store and recall settings, set the RS232/USB/GPIB settings, view the software version, update the firmware, perform self calibration, set the output impedance, change the language and configure DSO link.

Save and Recall	122
Selecting the Remote Interface	125
GPIB Interface	125
RS232 Interface	126
RS232 Parity/Bit Settings	127
USB Interface	128
System and Settings	129
Viewing and Updating the Firmware Version	129
Setting the output impedance	131
Language Selection	132
Setting the Sound Beep	133
Screen Capture	134
DSO Link	135

Save and Recall

The AFG-3000 has non-volatile memory to store instrument state and ARB data. There are 10 memory files numbered 0~9. Each memory file can either store arbitrary waveform data (ARB), settings or both. When data (ARB or Setting data) is stored in a memory file, the data will be shown in red. If a file has no data, it will be shown in blue.

Save/Recall properties	ARB	
	<ul style="list-style-type: none"> • Rate • Frequency • Length • Display horizontal 	<ul style="list-style-type: none"> • Display vertical • Output Start • Output length
	Setting	
	<ul style="list-style-type: none"> • Functions <ul style="list-style-type: none"> • Waveform • Frequency • Pulse Width • Square wave Duty • Ramp Symmetry • Amplitude • Amplitude unit • Offset • Modulation type • Beep setting • Impedance • Main output • Sweep <ul style="list-style-type: none"> • Source • Type • Trigger out 	<ul style="list-style-type: none"> • AM <ul style="list-style-type: none"> • Source • Shape • Depth • AM frequency • FM <ul style="list-style-type: none"> • Source • Shape • Deviation • FM frequency • FSK <ul style="list-style-type: none"> • Source • Shape • Rate • Hop frequency • PWM <ul style="list-style-type: none"> • Source

- Marker
- Time
- Start frequency
- Stop frequency
- Center frequency
- Span frequency
- Marker frequency
- Shape
- Duty
- Frequency
- Burst Type
- Source
- Trigger out
- Type
- Cycles
- Phase
- Period
- Delay

Panel Operation

1. Press the UTIL key.



2. Press F1 (Memory).



3. Choose a file operation:



Press F1 to store a file, press F2 to recall a file, or press F3 to delete a file.

- Use the scroll wheel to highlight a memory file. Press F1 (Select) to choose the file.

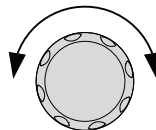

- Use the scroll wheel now to highlight the data type. Press F1 (Select) to choose the data type.

Range	Memory file	Memory0 ~ Memory9
	Data type	ARB, Setting, ARB+Setting

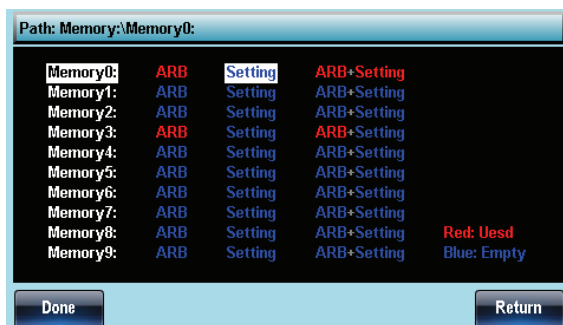

- Press F5 (Done) to confirm the operation.



Delete All

- To delete all the files for Memory0~Memory9, press F4.



- Press F1 (Done) to confirm the deletion of all files.







Selecting the Remote Interface

The AFG-3000 has RS232, GPIB and USB interfaces for remote control. Only one remote interface can be used at any one time.

GPIB Interface

Background When using the GPIB interface, a GPIB address must be specified. The default GPIB interface is 10.

- Panel Operation**
1. Press the UTIL key. 
 2. Press F2 (Interface). 
 3. Press F1 (GPIB). 
 4. Press F1 (Address) 
 5. GPIB will become highlighted.

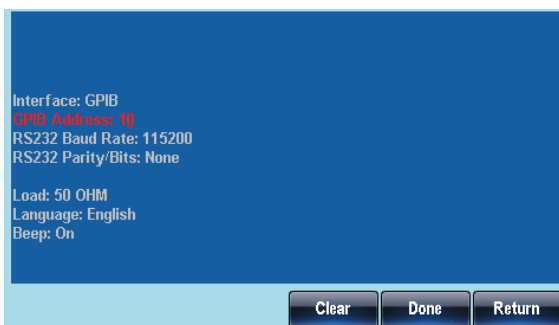

6. Use the selector keys and scroll wheel or number pad to enter the GPIB address.

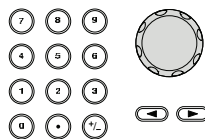

7. Press F5 (Done) to confirm the GPIB address.



Range	GPIB address	1~30
-------	--------------	------

RS232 Interface

Background When using the RS232 interface, a baud rate must be specified.

Panel Operation

1. Press the UTIL key.



2. Press F2 (Interface).



3. Press F2 (RS-232).



4. Press F1 (Baud Rate).



5. RS232 Baud Rate will become highlighted in the parameter window.

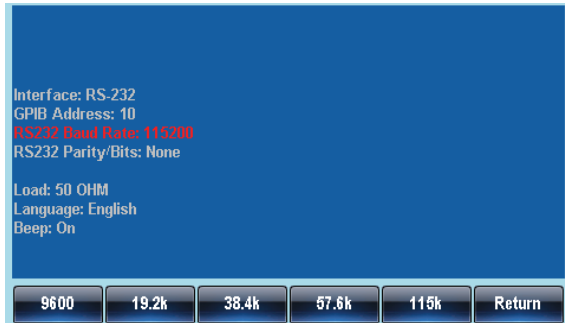





6. Press F1~F5 to choose a baud rate.



Range	Baud rate	9600, 19200, 38400, 57600, 115200
-------	-----------	-----------------------------------

RS232 Parity/Bit Settings

Background When RS232 is selected as the remote interface, parity can be configured. By default the parity is set to none with 8 data bits.

- Panel Operation**
1. Press the UTIL key. 
 2. Press F2 (Interface). 
 3. Press F2 (RS-232). 
 4. Press F2 (Parity). 
 5. The RS232 Parity/Bits will become highlighted in the parameter window.

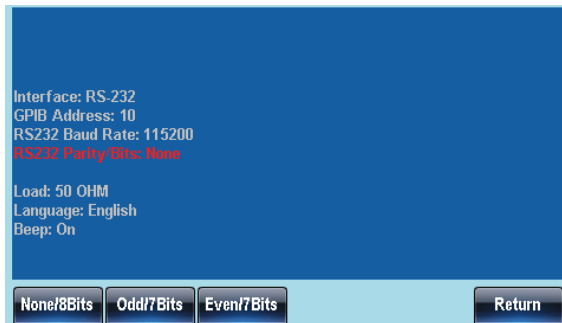

6. Press F1, F2 or F3 to choose the parity and bits.



Range None/8Bits, Odd/7Bits, Even/7Bits

USB Interface

Background For remote control via USB

Panel Operation 1. Press the UTIL key.



2. Press F2 (Interface).



3. Press F3 (USB).



System and Settings

There are a number of miscellaneous settings such as language options, output impedance settings, DSO link, and firmware settings that can be configured.

Viewing and Updating the Firmware Version

Panel Operation

1. Press the UTIL key.



2. Press F3 (Cal.).



3. Press F2 (Software).



View Version

4. To view the firmware version, press F1 (Version)



The version information will be shown on screen:
Instrument, Version, FPGA Revision, Bootload version

Update Firmware

5. To update the firmware, insert a USB flash drive with a firmware file in the USB host drive. Press F2 (Upgrade).



The firmware file (*.bin) must be located in a directory named UPGRADE, directly off the USB root directory. UPGRADE must be all capitals.

Interface: USB
GPIB Address: 10
RS232 Baud Rate: 115200
RS232 Parity/Bits: None

Load: 50 OHM
Language: English
Beep: On



Version

Upgrade





Return

Setting the output impedance

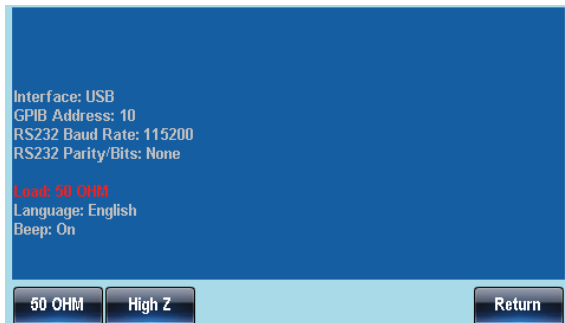
Background The AFG-3000 has selectable output impedances: 50Ω or high impedance. The default output impedance is 50Ω. The output impedances are to be used as a reference only. If the actual load impedance is different to that specified, then the actual amplitude and offset will vary accordingly.

- Panel Operation**
1. Press the UTIL key. 
 2. Press F4 (Load).  
 3. Load will become highlighted in red.



4. Select F1 (50 OHM) or F2 (High Z) to select the output impedance.    

Language Selection

Background The AFG-3000 can be operated in either English or Simplified Chinese. By default, the language is set to English.

Panel Operation 1. Press the UTIL key.



2. Press F5 (System).



3. Press F2 (Language).



4. The Language parameter will become highlighted.

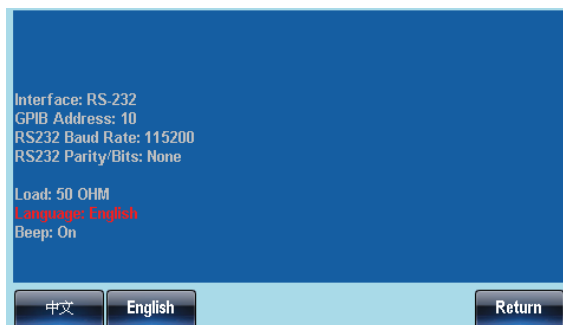

5. Select F1 (中文) or F2 (English) to choose the language.



Setting the Sound Beep

Background A beeper sound can be set on or off for when a key is pressed or the scroll wheel is turned.

Panel Operation

1. Press the UTIL key.



2. Press F5 (System).



3. Press F3 (Beep) to toggle the beeper on or off.



4. The Beep parameter will become highlighted.





Screen Capture

Background The function generator is able to capture screen shots and save them to a USB flash drive.

Connection 1. Insert a USB key into the USB port on the front panel. 

Panel Operation 2. Press the UTIL key. 

3. Press F5 (System).  

4. Press F1 (Hardcopy).  

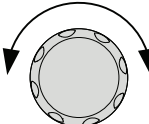
5. Use the scroll wheel to scroll through the different screen shots. A screen shot is captured each time a function is used. 

Function: Waveform, ARB, MOD (AM, FM, FSK, PWM), Sweep, Burst, UTIL

6. When a screen is selected, press F1 to save the screen shot. The utility menu will reappear after 2 seconds. This indicates that the screen shot was saved. 

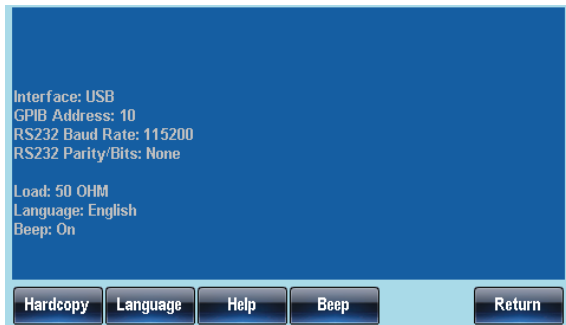

DSO Link

Background

DSO Link enables the AFG-3000 to receive lossless data from a GDS-2000 Series DSO to create ARB data.

1. Connect the AFG-3000 USB host port to the GDS-2000's USB B device port.

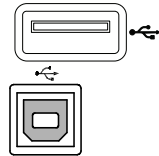

Panel Operation

2. Press the UTIL key.



3. Press F6 (DSOLink).



4. Press F1 (Search).



5. To select the DSO channel, press F2 (CH1), F3 (CH2), F4 (CH3) or F5 (CH4). The acquired data can then be displayed.





ARBITRARY WAVEFORMS

The AFG-3000 can create user-defined arbitrary waveforms. Each waveform can include up to 1M data points. Each data point has a vertical range of 65535 (± 32767) with a sample rate of 200MHz.

Inserting Built-In Waveforms	138
Creating a Sine Waveform.....	138
Creating a Square Waveform	139
Creating a Ramp Waveform.....	141
Creating a Sinc Waveform.....	142
Creating an Exponential Rise Waveform	144
Creating an Exponential Fall Waveform	145
Creating a DC Waveform	147
Creating a Pulse Waveform.....	148
Display an Arbitrary Waveform	151
Set the Horizontal Display Range.....	151
Set the Vertical Display Properties.....	153
Page Navigation (Back Page).....	155
Page Navigation (Next Page).....	156
Display.....	157
Editing an Arbitrary Waveform	158
Adding a point to an Arbitrary Waveform.....	158
Adding a line to an Arbitrary Waveform	159
Copy a Waveform	161
Clear the Waveform.....	163
ARB Protection	165
Output an Arbitrary Waveform.....	168
Output an Arbitrary Waveform	168
Output an N Cycle Arbitrary Waveform.....	169
Output Arbitrary Waveforms – Infinite Cycles.....	171
Output Markers.....	172
Saving/Loading an Arbitrary Waveform.....	174
Saving a Waveform to Internal Memory.....	174
Saving a Waveform to USB Memory	175
Load a Waveform from Internal Memory.....	178
Load a Waveform from USB	180

Inserting Built-In Waveforms

The AFG-3000 Series contain a number of functions to create a number of common waveforms including sine, square, ramp, sinc, exponential rise, exponential fall and DC waveforms.

Creating a Sine Waveform

Panel Operation

1. Press the ARB key.



2. Press F3(Built in).



3. Press F1 (Sine).



4. Press F1 (Start).



5. The Start property will become highlighted in red.

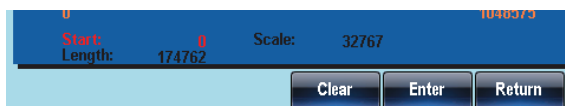

6. Use the selector keys and scroll wheel or number pad to enter the Start address.

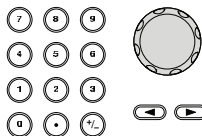

7. Press F5 (Enter) to confirm the Start point.



8. Press F6 (Return) to return to the previous menu.



9. Repeat steps 4~8 for Length (F2) and Scale (F3).

Length ~ Scale

F 2
F 3

10. Press F4 (Done) to complete the operation.

Done
F 4

11. Press F6 (Return) to return to the previous menu.

Return
F 6

Below a sine wave created at start:0, Length: 524288, Scale: 32767

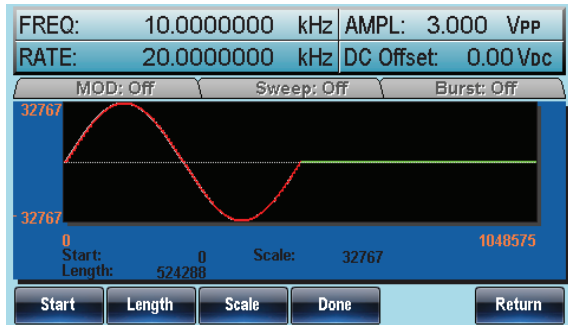

Creating a Square Waveform

- Panel Operation
1. Press the ARB key.

ARB

 2. Press F3 (Built in).

Built in
F 3

 3. Press F2 (Square).







Square
F 2

 4. Press F1 (Start).

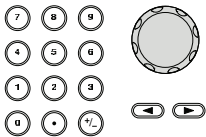
Start
F 1

 5. The Start property will become highlighted in red.







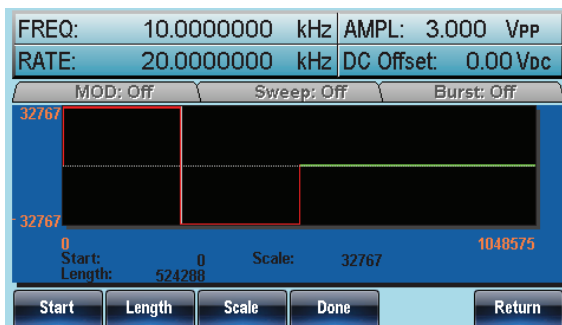

6. Use the selector keys and scroll wheel or number pad to enter the Start address.
 
7. Press F5 (Enter) to confirm the Start point.
 
8. Press F6 (Return) to return to the previous menu.
 
9. Repeat steps 4~8 for Length (F2) and Scale (F3).
 
10. Press F4 (Done) to complete the operation.
 
11. Press F6 (Return) to return to the previous menu.
 

Below a square wave created at start:0, Length: 524288, Scale: 32767



Creating a Ramp Waveform





- Panel Operation
1. Press the ARB key. 
 2. Press F3 (Built in).  
 3. Press F3 (Ramp).  
 4. Press F1 (Start).  
 5. The Start property will become highlighted in red.

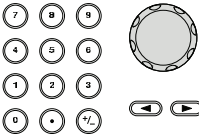

0 1048575

Start: 0 Scale: 32767

Length: 174762

Clear Enter Return
 6. Use the selector keys and scroll wheel or number pad to enter the Start address.



 7. Press F5 (Enter) to confirm the Start point.  
 8. Press F6 (Return) to return to the previous menu.  
 9. Repeat steps 4~8 for Length (F2) and Scale (F3).

 10. Press F4 (Done) to complete the operation.  

11. Press F6 (Return) to return to the previous menu.

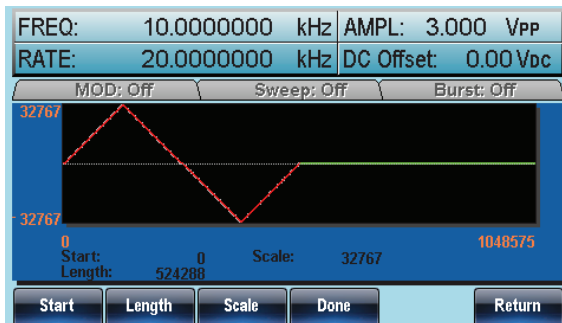

Below a ramp wave created at start:0, Length: 524288, Scale: 32767



Creating a Sinc Waveform

Panel Operation

1. Press the ARB key.



2. Press F3 (Built in).



3. Press F4 (Sinc).







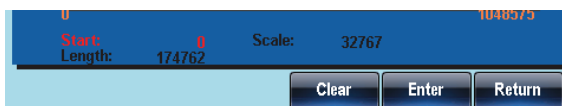

4. Press F1 (Start).

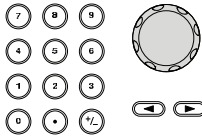

5. The Start property will become highlighted in red.



6. Use the selector keys and scroll wheel or number pad to enter the Start address.
 
7. Press F5 (Enter) to confirm the Start point.
 
8. Press F6 (Return) to return to the previous menu.
 
9. Repeat steps 4~8 for Length (F2) and Scale (F3).
 
10. Press F4 (Done) to complete the operation.
 
11. Press F6 (Return) to return to the previous menu.
 

Below a sinc wave created at start:0, Length: 524288, Scale: 32767

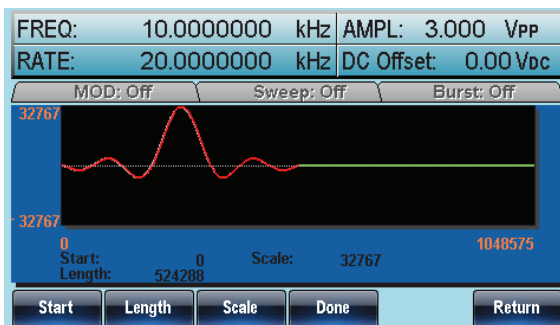

Creating an Exponential Rise Waveform

Panel Operation

1. Press the ARB key.



2. Press F3 (Built in).



3. Press F5 (More).



4. Press F1 (Exp Rise).



5. Press F1 (Start).



6. The Start property will become highlighted in red.

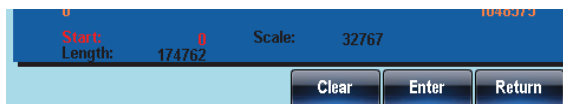

7. Use the selector keys and scroll wheel or number pad to enter the Start address.

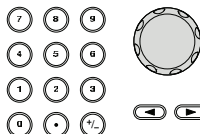

8. Press F5 (Enter) to confirm the Start point.



9. Press F6 (Return) to return to the previous menu.



10. Repeat steps 4~8 for Length (F2) and Scale (F3).



11. Press F4 (Done) to complete the operation. Done F 4

12. Press F6 (Return) to return to the previous menu. Return F 6



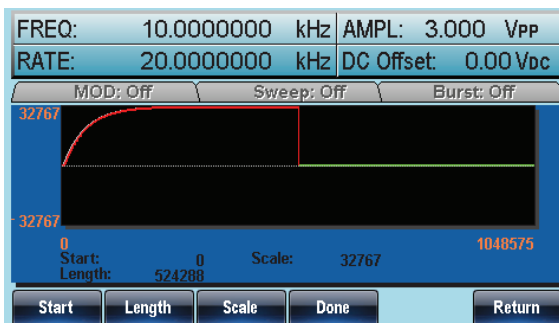



Below an exponential rise wave created at start:0, Length: 524288, Scale: 32767

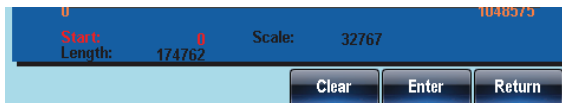

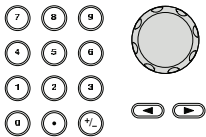
Creating an Exponential Fall Waveform

- Panel Operation
1. Press the ARB key. ARB
 2. Press F3 (Built in). Built in F 3
 3. Press F5 (More). More F 5
 4. Press F2 (Exp Fall). Exp Fall F 2
 5. Press F1 (Start). Start F 1
 6. The Start property will become highlighted in red.







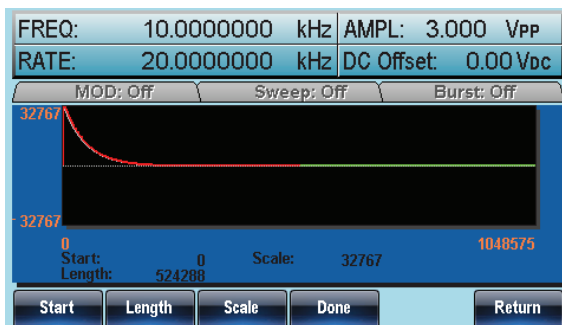



7. Use the selector keys and scroll wheel or number pad to enter the Start address.
 
8. Press F5 (Enter) to confirm the Start point.
 
9. Press F6 (Return) to return to the previous menu.
 
10. Repeat steps 4~8 for Length (F2) and Scale (F3).
 
11. Press F4 (Done) to complete the operation.
 
12. Press F6 (Return) to return to the previous menu.
 







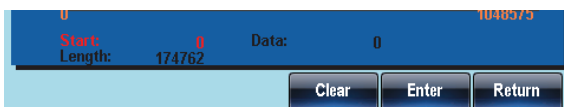

Below an exponential fall wave created at start:0, Length: 524288, Scale: 32767.

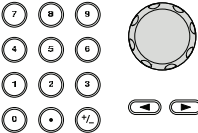





Creating a DC Waveform

- Panel Operation
1. Press the ARB key. 
 2. Press F3 (Built in).  
 3. Press F5 (More).  
 4. Press F3 (DC).  
 5. Press F1 (Start).  
 6. The Start property will become highlighted in red.



7. Use the selector keys and scroll wheel or number pad to enter the Start address. 
8. Press F5 (Enter) to confirm the Start point.  
9. Press F6 (Return) to return to the previous menu.  
10. Repeat steps 4~8 for Length (F2) and Data (F3).  
 

11. Press F5 (Done) to complete the operation.  



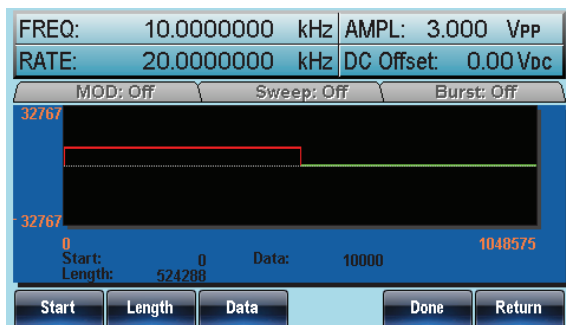

12. Press F6 (Return) to return to the previous menu.  

Below a DC waveform created at start:0, Length: 524288, Data: 10000.



Creating a Pulse Waveform

Range	Frequency	Resolution	Duty Resolution
	1pHz~5Hz	1pHz	0.0001%
	>5Hz~50Hz	1uHz	0.0001%
	>50Hz~500Hz	10uHz	0.001%
	>500Hz~5kHz	100uHz	0.01%
	>5kHz~50kHz	1mHz	0.1%
	>50kHz~500kHz	10mHz	1%

- Panel Operation
1. Press the ARB key. 
 2. Press F3 (Built in).  
 3. Press F5 (More).  

4. Press F4 (Pulse).



5. Press F1 (Freq).



6. The Pulse Freq property will become highlighted in red.

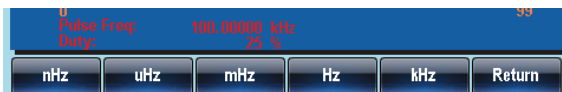

7. Use the selector keys and scroll wheel or number pad to enter the pulse frequency.

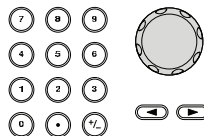

8. Press F1~F5 to select the frequency unit.



9. Press F6 (Return) to return to the previous menu.



10. Press F2 (Duty) and use the number pad or scroll wheel to choose the duty.

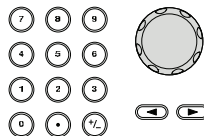

11. Press F5 (%) to complete the operation.



12. Press F6 (Return) to return to the previous menu.



13. Press F5 (Done) to complete the operation.



14. Press F6 (Return) to return to the previous menu.



Below a Pulse waveform created with a frequency of 200Hz and a duty cycle of 25%.

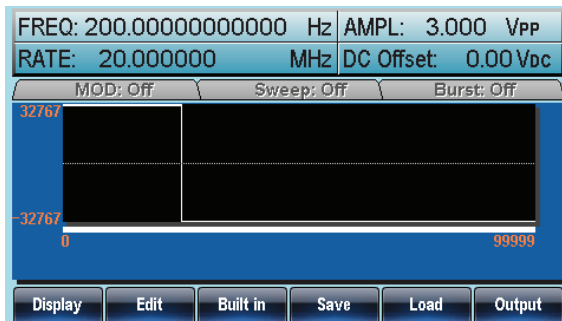

Display an Arbitrary Waveform

Set the Horizontal Display Range

The horizontal window bounds can be set in one of two ways: Using a start point and length, or a center point and length.

Panel Operation

1. Press the ARB key.



2. Press F1 (Display) to enter the display menu.



3. Press F1 (Horizon) to enter the horizontal menu.



Using a Start Point

4. Press (F1) Start.



5. The parameter Horizontal From will become highlighted.

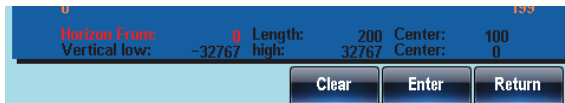

6. Use the selector keys and scroll wheel or number pad to enter the Horizontal from value.

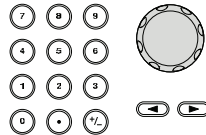











7. To undo, Clear (F4, Not F1) can be pressed before Enter is used.



8. Press F5 (Enter) to save settings.





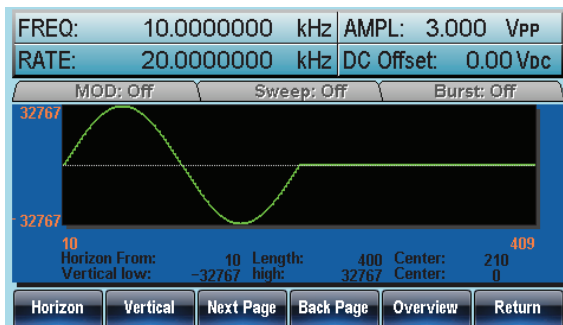

- | | | | |
|----------------------|---|---|---|
| | 9. Press F6 (Return) to return to the previous menu. |  |  |
| Setting the Length. | 10. Repeat steps 4~9 for Length (F2). |  |  |
| Using a Center Point | 11. Repeat steps 4~9 for Length (F3). |  |  |
| Zoom in | 12. To zoom into the arbitrary waveform, press F4 (Zoom In). The Zoom In function will reduce the length by half each time the function is used. The minimum allowable length is 3. |  |  |
| Zoom out | 13. To zoom out from the center point of the waveform, press F5 (Zoom out). The Zoom out function will increase the length by 2. The maximum allowable length is 1048576. |  |  |



Below, an arbitrary sine waveform has a start of 10, length of 400 and is centered at 210.







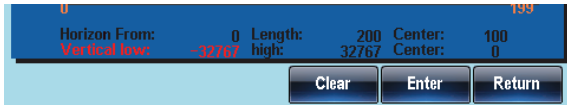

Set the Vertical Display Properties

Like the horizontal properties, the vertical display properties of the waveform display can be created in two ways: Setting high and low values, or setting the center point.

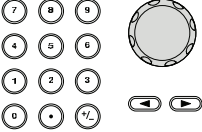
- | | | |
|-----------------|-------------------------|---|
| Panel Operation | 1. Press the ARB key. |  |
| | 2. Press F1 (Display). |   |
| | 3. Press F2 (Vertical). |   |

- | | | |
|-----------------------|--|---|
| Setting the Low Point | 4. Press F1 (Low). |   |
| | 5. The parameter Vertical Low will become highlighted. | |



- | | |
|--|---|
| 6. Use the selector keys and scroll wheel or number pad to enter the Vertical Low value. |  |
| 7. To undo, Clear (F4) can be pressed before Enter is used. |   |
| 8. Press F5 (Enter) to save settings. |   |
| 9. Press F6 (Return) to return to the previous menu. |   |

Setting the High Point 10. Repeat steps 4~9 for High Point **High** **F 2**

Setting the Center Point 11. Repeat steps 4~9 for Length (F3). **Center** **F 3**

Zoom 12. To zoom in from the center of the arbitrary waveform, press F4 (Zoom In). The Zoom In function will reduce the length by half each time the function is used. The minimum allowable vertical low is -2, and the minimum vertical high is 2.



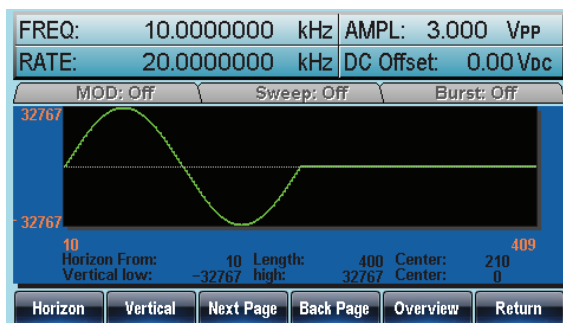

13. To zoom out of the waveform, press F5 (Zoom out). The Zoom out function will increase the length by 2. The Vertical low maximum can be set to -32767 and the vertical high maximum can be set to +32767.

Below, the sine wave is with a vertical low of -32767, a vertical high 32767 and a center of 0.



Page Navigation (Back Page)

Background When viewing the waveform, the display window can be moved forward and backward using the Next/Back Page functions.

- Panel Operation**
1. Press the ARB key. 
 2. Press F1 (Display).  
 3. Press F4 (Back Page) to move the display window one view length backward.  

$$\text{Horizon start}^* = \text{Horizon start} - \text{Length}$$

$$\text{Center}^* = \text{Center} - \text{Length}$$

*Length until 0

Below, shows the display after Back Page has been pressed.

Horizon From: 10 → 0



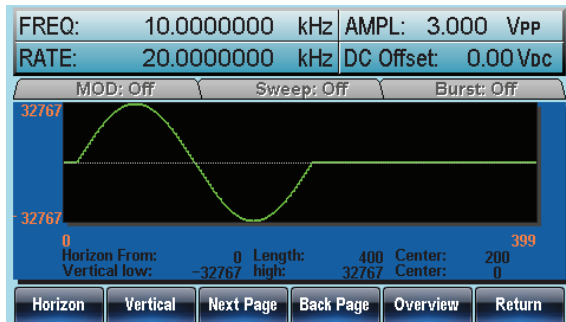

Length: 400

Center: 210 → 200



Page Navigation (Next Page)

Background When viewing the waveform, the display window can be moved forward and backward using the Next/Back Page functions.

- Panel Operation**
1. Press the ARB key. 
 2. Press F1 (Display).  
 3. Press F3 (Next Page) to move the display window one view length forward.  

Horizon start* = Horizon start + Length

Center = Center + Length

*Horizon start + Length ≤ 1048576

Below, shows the display after Next Page has been pressed.

Horizon From: 10 → 410

Length: 400

Center: 210 → 610

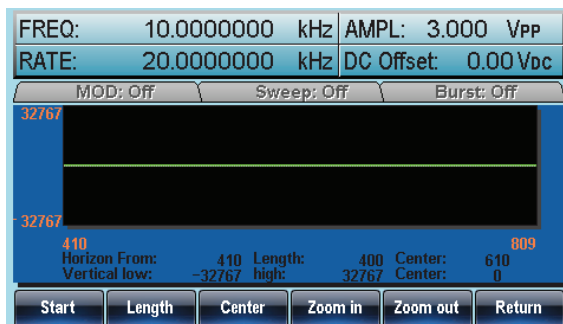

Display

Panel Operation

1. Press the ARB key.



2. Press F1 (Display).



3. To make the display window cover the whole waveform, press F5 (Overview).



Horizontal: 0~1048575,
Vertical: 32767~ -328767

Below shows the display after Overview has been selected.

Horizon From: 0 → 0
Length: 400→1048576
Center:200→ 524288
Vertical low/high: ±32767

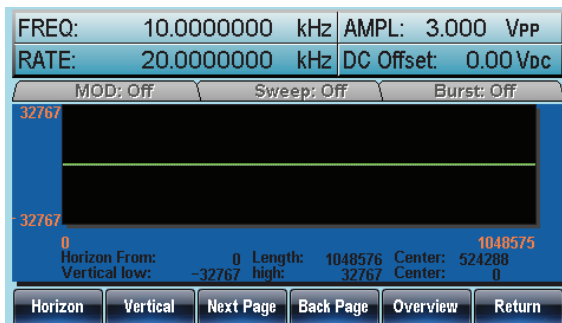

Editing an Arbitrary Waveform

Adding a point to an Arbitrary Waveform

Background The AFG-3000 has a powerful editing function that allows you to create points or lines anywhere on the waveform.

Panel Operation 1. Press the ARB key.



2. Press F2 (Edit).



3. Press F1 (Point).



4. Press F1 (Address).



5. The Address parameter will become highlighted in red.



6. Use the selector keys and scroll wheel or number pad to enter the Address value.

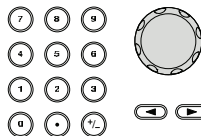

7. Press F5 (Enter) to save settings.



8. Press F6 (Return) to return to the previous menu.



9. Press F2 (Data).



10. The Value parameter will become highlighted in red.

11. Use the selector keys and scroll wheel or number pad to enter a Data value.

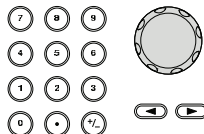

12. Press F5 (Enter) to save settings.



13. Press F6 (Return) to return to the previous menu.



14. Press F6 (Return) again to return to the ARB menu.



Below shows Address and Data set to 40 and 30,000. The edited area is shown in red.



Adding a line to an Arbitrary Waveform

Background

The AFG-3000 has a powerful editing function that allows you to create points or lines anywhere on the waveform.

Panel Operation

1. Press the ARB key.



2. Press F2 (Edit).



3. Press F2 (Line).



4. Press F1 (Start ADD).



5. The Start Address parameter will become highlighted in red.

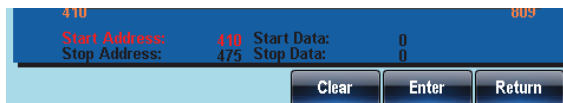

6. Use the selector keys and scroll wheel or number pad to enter the start address.

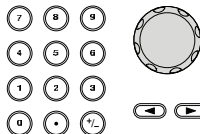

7. Press F5 (Enter) to save settings.



8. Press F6 (Return) to return to the previous menu.



9. Repeat steps 4~8 for Start Data (F2), Stop Address (F3) and Stop Data (F4)

10. Press F5 (Done) to confirm the line edit.



11. Press F6 (Return) to return to the previous menu.



A red line was created below with the following properties:

Start Address: 10, Start Data: 30

Stop Address: 50, Stop Data: 100

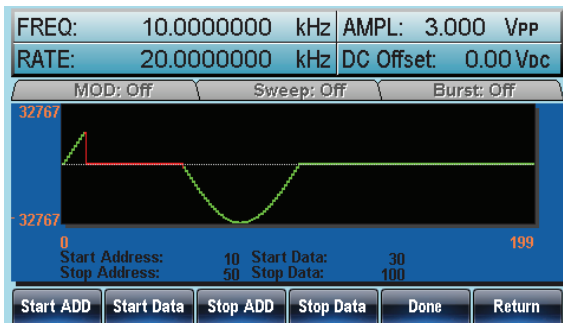

Copy a Waveform

Panel Operation 1. Press the ARB key.



2. Press F2 (Edit).



3. Press F3 (Copy).



4. Press F1 (Start).



5. The Copy From properties will become highlighted in red.

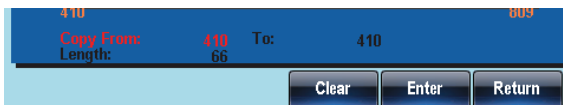

6. Use the selector keys and scroll wheel or number pad to enter the Copy From address.

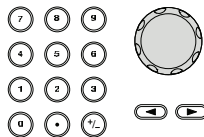

7. Press F5 (Enter) to save settings.



8. Press F6 (Return) to return to the previous menu.



9. Repeat steps 4~8 for Length (F2) and Paste To (F3).

10. Press F5 (Done) to confirm the selection.



11. Press F6 (Return) to return to the previous menu.



A section of the waveform from points 50~80 was copied to points 100~130:







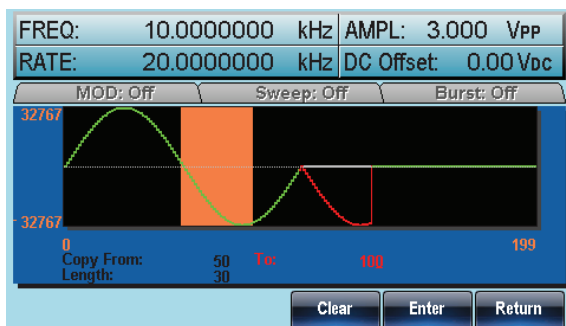

Copy From: 50

Length: 30

To: 100

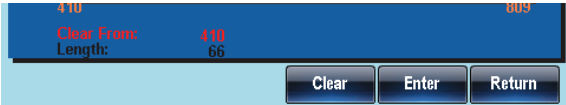
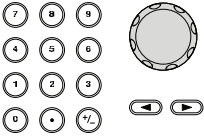

Clear the Waveform

- | | | |
|-----------------|--|---|
| Panel Operation | <ol style="list-style-type: none"> 1. Press the ARB key. |  |
| | <ol style="list-style-type: none"> 2. Press F2 (Edit). |  |
| | <ol style="list-style-type: none"> 3. Press F4 (Clear). |  |
| | <ol style="list-style-type: none"> 4. Press F1 (Start). |  |
| | <ol style="list-style-type: none"> 5. The Clear From property will become highlighted in red. | |
| | |  |
| | <ol style="list-style-type: none"> 6. Use the selector keys and scroll wheel or number pad to enter the Clear From address. |  |
| | <ol style="list-style-type: none"> 7. Press F5 (Enter) to save settings. |  |
| | <ol style="list-style-type: none"> 8. Press F6 (Return) to return to the previous menu. |  |
| | <ol style="list-style-type: none"> 9. Repeat steps 4~8 for Length (F2). |  |
| | <ol style="list-style-type: none"> 10. Press F3 (Done) to clear the section of the arbitrary waveform. |  |

11. Press F6 (Return) to return to the previous menu.



12. Press F5 (ALL) to delete the whole waveform.



Delete All

13. Press F5 (Done) again to confirm the deletion.



14. Press F6 (Return) to return to the previous menu.



Start: 100, Length: 50.

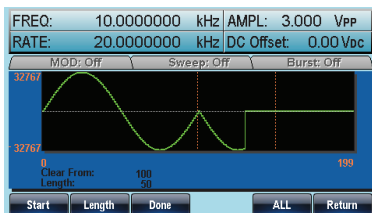

The same area after being cleared.

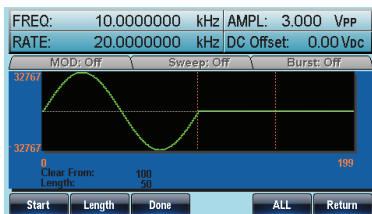

The result after the whole waveform is deleted.

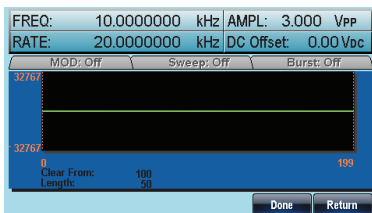

ARB Protection

The protection function designates an area of the arbitrary waveform that cannot be altered.

Panel Operation

1. Press the ARB key.



2. Press F2 (Edit).



3. Press F5 (Protect).



4. Press F2 (Start).



5. The Protect Start property will become highlighted in red.

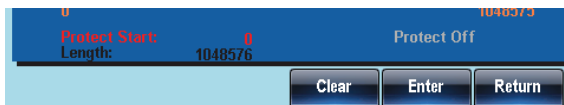

6. Use the selector keys and scroll wheel or number pad to enter the Protect Start address.

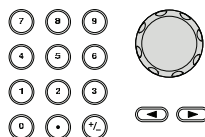

7. Press F5 (Enter) to save settings.



8. Press F6 (Return) to return to the previous menu.



















9. Repeat steps 4~8 for Length (F3).



10. Press F5 (Done) to confirm the protected area.



	11. Press F6 (Return) to return to the previous menu.		
	12. Press F4 (Done) to protect the selected region or the waveform.		
<hr/>			
Protect All	13. Press F1 (ALL) to delete the whole waveform.		
	14. Press F6 (Done) to confirm.		
	15. Press F6 (Return) to return to the previous menu.		
<hr/>			
Unprotect All	16. Press F5 (Unprotect) to delete the whole waveform.		
	17. Press F6 (Done) to confirm.		
	18. Press F6 (Return) to return to the previous menu.		
	19. The waveform background will return back to black. The property “Unprotected” be will grayed out.		

Below, the protected areas of the waveform are shown with an orange background:

Start:0, Length: 200000.

FREQ:	10.0000000 kHz	AMPL:	3.000 Vpp
RATE:	20.0000000 kHz	DC Offset:	0.00 Vdc
MOD: Off		Sweep: Off	
Burst: Off			

0 Protect Start: 0 Protect On 1048575
Length: 200000

ALL Start Length Done Unprotect Return

Output an Arbitrary Waveform

Up to 1 Mpts (0~1048575) of an arbitrary waveform can be output from the function generator. Arbitrary waveforms can also be output for a defined or infinite amount of cycles.

The output can also be output as pulse widths from the marker output.

Output an Arbitrary Waveform

Panel Operation

1. Press the ARB key.



2. Press F6 (Output).



3. Press F1 (Start).



4. The Start property will become highlighted in red.

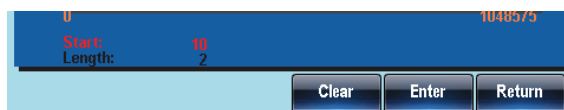

5. Use the selector keys and scroll wheel or number pad to enter the Start address.

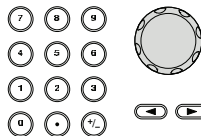

6. Press F5 (Enter) to confirm the Start point.



7. Press F6 (Return) to return to the previous menu.



8. Repeat steps 4~7 for Length (F2). Length F 2

9. Press F6 (Return) to return to the previous menu. Return F 6

Below the waveform from position 0 with a length of 100 is output from the front panel terminal.

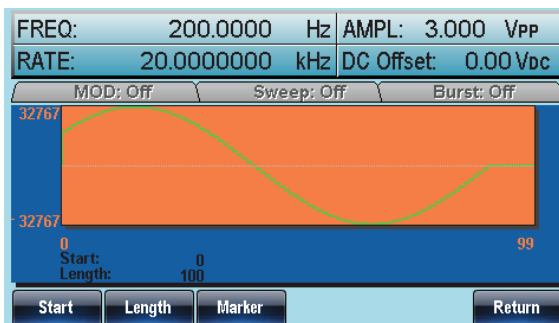

Output an N Cycle Arbitrary Waveform

Background The output of an arbitrary waveform can be repeated for a designated number of cycles. The N Cycle function uses a soft key trigger to trigger the output.

Range 1 to 1048575 cycles

- Panel Operation**
1. Press the ARB key. ARB

 2. Press F6 (Output). Output F 6

 3. Define the Start and Length of the arbitrary waveform output. Page 168.

Note: Changing the length will change the duty/frequency of pulse waveforms.



4. Press F4 (N Cycle).  

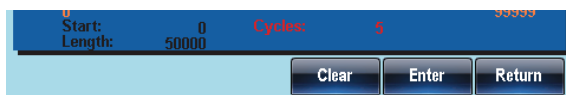

5. Press F1 (Cycles).  

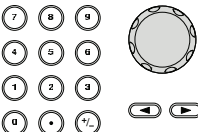

6. The Cycles property will become highlighted in red.





7. Use the selector keys and scroll wheel or number pad to enter the number of cycles. 

8. Press F5 (Enter) to confirm the number of cycles.  

9. Press F6 (Return) to return to the previous menu.  

10. Press Trigger (F5) to internally trigger the output once.  

Note: Ensure the output key has already been pressed and the OUTPUT light is lit *before* pressing F5 (Trigger).

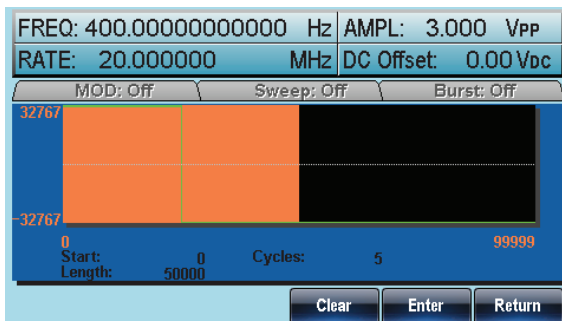

11. Press F6 (Return) to return to the previous menu.  

Below a pulse waveform of 5 cycles is output from the front panel terminal.







Output Arbitrary Waveforms – Infinite Cycles

Background The output of an arbitrary waveform can be repeated an infinite amount of times to create a cyclic waveform.

- Panel Operation**
1. Press the ARB key. 
 2. Press F6 (Output).  
 3. Define the Start and Length of the arbitrary waveform output. [Page 168.](#)

Note: Changing the length will change the duty/frequency of pulse waveforms.

4. Press F5 (Infinite) to output the arbitrary waveform infinitely.  
5. Press F6 (Return) to return to the previous menu.  

Below an infinite pulse waveform is output from the front panel terminal.

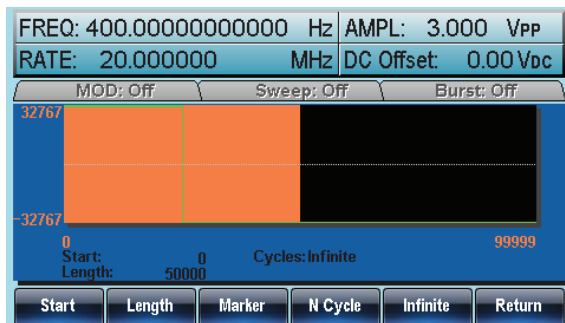

Output Markers

Panel Operation

1. Press the ARB key.



2. Press F6 (Output).



3. Press F3 (Marker).



4. Press F1 (Start).



5. The Start property will become highlighted in red.

6. Use the selector keys and scroll wheel or number pad to enter the Start address.

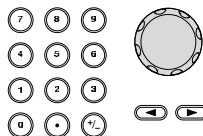

7. Press F5 (Enter) to confirm the Start point.



8. Press F6 (Return) to return to the previous menu.



9. Repeat steps 4~8 for Length (F2).



10. Press F6 (Return) to return to the previous menu.



Marker Output

Use the MARK output terminal on the rear panel when outputting markers.

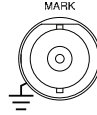

Below shows the marker output from point 30 to 80 (Start: 30, Length 50).

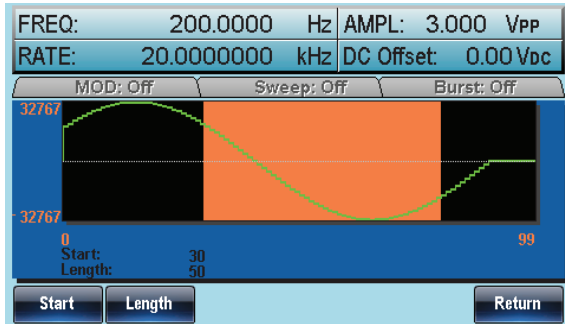

Saving/Loading an Arbitrary Waveform

The AFG-3000 Series contain a number of functions to create a number of common waveforms including sine, square, ramp, sinc, exponential rise, exponential fall and DC waveforms.

Saving a Waveform to Internal Memory

Panel Operation

1. Press the ARB key.



2. Press F4 (Save).



3. Press F1 (Start).



4. The Start property will become highlighted in red.

5. Use the selector keys and scroll wheel or number pad to enter the Start address.

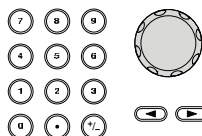

6. Press F5 (Enter) to confirm the Start point.



7. Press F6 (Return) to return to the previous menu.



8. Repeat steps 4~8 for Length (F2).



9. Press F3 (Memory).



10. Select a memory file using the scroll wheel.

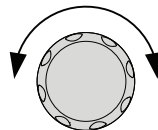

ARB0~ARB9

11. Press F1 (Select) to save the waveform to the selected file.



12. Press F6 (Return) to return to the previous menu.



Below the file ARB1 is selected using the scroll wheel.

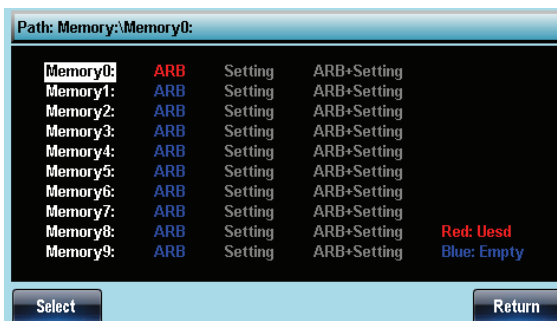

Saving a Waveform to USB Memory

Panel Operation

1. Press the ARB key.



2. Press F4 (Save).



3. Press F1 (Start).



4. The Start property will become highlighted in red.

5. Use the selector keys and scroll wheel or number pad to enter the Start address.

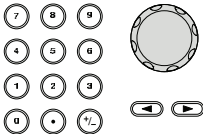

6. Press F5 (Enter) to confirm the Start point.



7. Press F6 (Return) to return to the previous menu.



8. Repeat steps 4~8 for Length (F2).



1. Press F4 (USB).



2. Use the scroll wheel to navigate the filesystem.

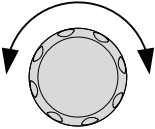

3. Press Select to select directories or file names.



Create a Folder 4. Press F2 (New Folder).



5. The text editor will appear with a default folder name of "NEW_FOL".

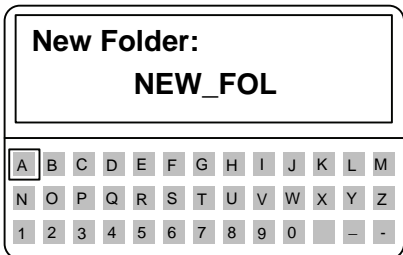

6. Use the scroll wheel to move the cursor.

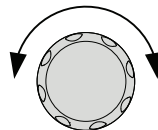

7. Use F1 (Enter Char) or F2 (Backspace) to create a folder name.



8. Press F5 (Save) to save the folder name.



Create New File

9. Press F3 (New File).



10. The text editor will appear with a default file name of "NEW_FIL".

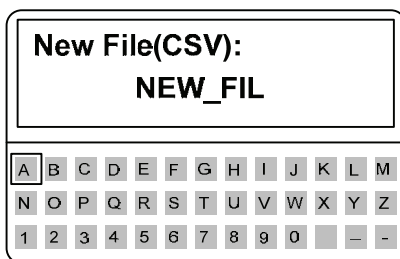

11. Use the scroll wheel to move the cursor.

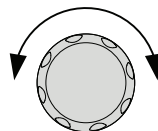

12. Use F1 (Enter Char) or F2 (Backspace) to create a file name.



13. Press F5 (Save) to save the file name.



Below the folder ABC and the file AFG.CSV have been created in the root directory.

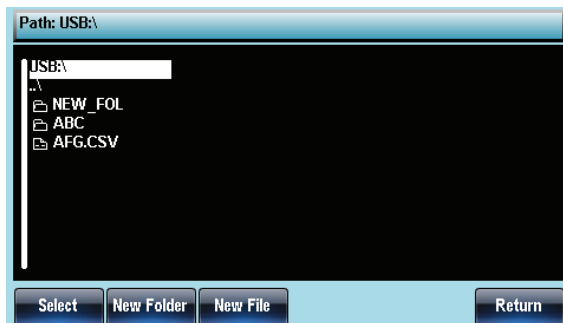

Load a Waveform from Internal Memory

Panel Operation

1. Press the ARB key.



2. Press F5 (Load).



3. Press F1 (Memory).



4. Use the scroll wheel to navigate the filesystem.

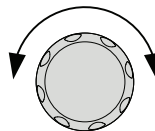

5. Press Select to select directories or file names.



6. Press F3 (To) to choose the starting point for the loaded waveform.



- The "Load To" property will become highlighted in red.

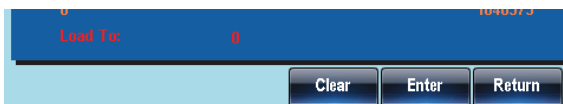

- Use the selector keys and scroll wheel or number pad to enter the starting point.

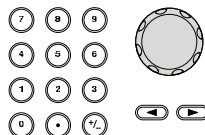

- Press F5 (Enter) to confirm the Start point.



- Press F6 (Return) to go back to the previous menu.







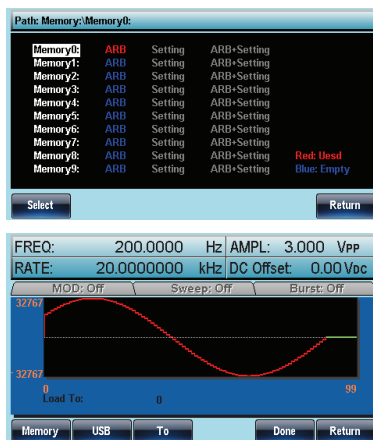

- Press F5 (Done).



Below the file ARB1 is selected using the scroll wheel loaded to position 0.

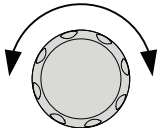

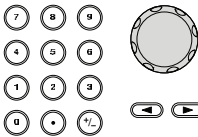
Load a Waveform from USB

- Panel Operation
1. Press the ARB key.
 
 2. Press F5 (Load).
 
 3. Press F2 (USB).
 
 4. Use the scroll wheel to choose a file name.
 
 5. Press F1 (Select) to select the file to load.
 
 6. Press F3 (To) to choose the starting point for the loaded waveform.
 
 7. The "Load To" property will become highlighted in red.
 8. Use the selector keys and scroll wheel or number pad to enter the starting point.
 
 9. Press F5 (Enter) to confirm the Start point.
 
 10. Press F5 (Done).
 

Below the file AFG.CSV is selected using the scroll wheel loaded to position 0.

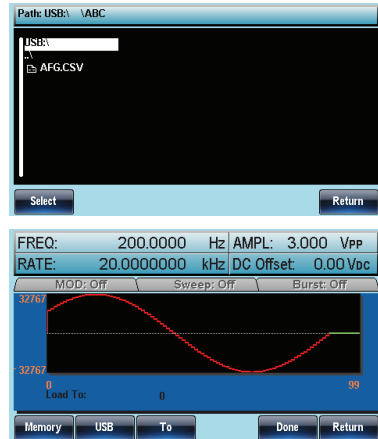

REMOTE INTERFACE

Establishing a Remote Connection	183
Configure USB interface	183
Configure RS232 interface	184
Configure GPIB interface	185
Remote control terminal connection.....	186
Command Syntax.....	188
Command List	193
System Commands	196

Establishing a Remote Connection

The AFG-3000 supports USB, RS232 and GPIB remote connections.

Configure USB interface

USB configuration	PC side connector	Type A, host
	AFG-3000 side connector	Type B, slave
	Speed	1.1/2.0 (full speed)

Panel Operation

1. Press the Utility key followed by Interface (F2) and USB (F3).



2. Connect the USB cable to the rear panel USB B (slave) port.



3. When the PC asks for the USB driver, select XXXXXXXX.inf included in the software package or download the driver from the GW website, www.gwinstek.com.

Configure RS232 interface

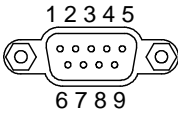
RS-232C configuration	Connector	DB-9, Male
	Baud rate	9600, 19200, 38400, 57600, 115200
	Parity	None/8Bits, Odd/7Bits, Even/7Bits
	Stop bits	1 (fixed)
Pin assignment		2: RxD (Receive data) 3: TxD (Transmit data) 5: GND 4, 6 ~ 9: No connection

PC connection Use the Null Modem connection as in the below diagram.

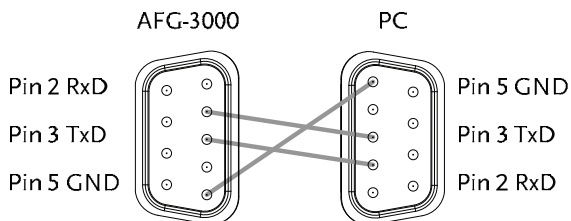

Panel Operation

1. Connect the RS-232 cable to the rear panel RS-232 port.

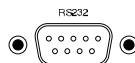

2. Press the Utility key followed by Interface (F2) and RS-232 (F2).



3. Press Baud Rate (F1) and choose a baud rate (F1)~(F5). Press return

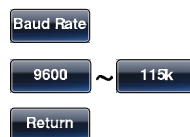

- Press Parity/Bits (F2) and choose a parity (F1)~(F3). Press return.

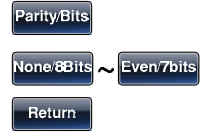

Configure GPIB interface

GPIB configuration	Connector	24 pin Female
	GPIB address	1-30

- GPIB constraints
- Maximum 15 devices altogether, 20m cable length, 2m between each device
 - Unique address assigned to each device
 - At least 2/3 of the devices turned On
 - No loop or parallel connection

Pin assignment

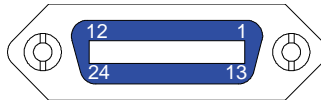

Pin1	Data line 1	Pin13	Data line 5
Pin2	Data line 2	Pin14	Data line 6
Pin3	Data line 3	Pin15	Data line 7
Pin4	Data line 4	Pin16	Data line 8
Pin5	EOI	Pin17	REN
Pin6	DAV	Pin18	Ground
Pin7	NRFD	Pin19	Ground
Pin8	NDAC	Pin20	Ground
Pin9	IFC	Pin21	Ground
Pin10	SRQ	Pin22	Ground
Pin11	ATN	Pin23	Ground
Pin12	Shield (screen)	Pin24	Signal ground

- Panel Operation
- Connect the GPIB cable to the rear panel GPIB port.

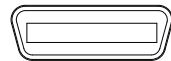

2. Press the Utility key followed by Interface and GPIB. Press Address (F1).



3. Use the scroll wheel or number pad to choose an address.

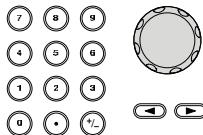

4. Press Done (F5) to confirm.



Remote control terminal connection

Terminal application

Invoke the terminal application such as MTTY (Multi-Threaded TTY). For RS-232C, set the COM port, baud rate, stop bit, data bit, and parity accordingly.

To check the COM port No, see the Device Manager in the PC. For WinXP, Control panel → System → Hardware tab.

Functionality check

Run this query command via the terminal.
*!dn?

This should return the Manufacturer, Model number, Serial number, and Firmware version in the following format.

GW INSTEK, AFG-3081, SN:XXXXXXXX, Vm.mm

Note: ^j or ^m can be used as the terminal character when using a terminal program.

PC Software

The proprietary PC software, downloadable from GWInstek website, can be used for remote control.

Display

When a remote connection is established all panel keys are locked bar F6.

1. Press REM/LOCK (F6) to return the function generator to local mode.

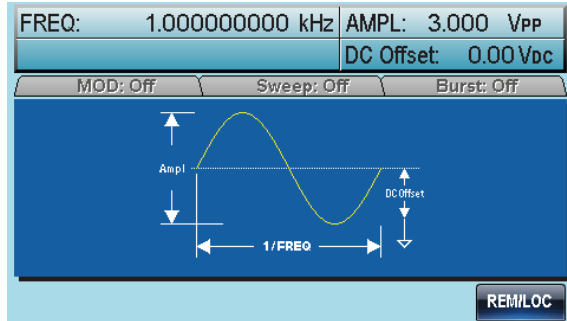

Command Syntax

- | | |
|---------------------|---|
| Compatible standard | <ul style="list-style-type: none"> • IEEE488.2, 1992 (fully compatible) • SCPI, 1994 (partially compatible) |
|---------------------|---|

Command Tree	The SCPI standard is an ASCII based standard that defines the command syntax and structure for programmable instruments.
--------------	--

Commands are based on a hierarchical tree structure. Each command keyword is a node on the command tree with the first keyword as the root node. Each sub node is separated with a colon.

Shown below is a section of the SOURce[1] root node and the :PWM and :PULSe sub nodes.

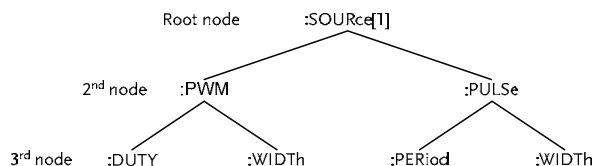

Command types	Commands can be separated in to three distinct types, simple commands, compound commands and queries.
---------------	---

Simple	A single command with/without a parameter
--------	---

Example	*OPC
---------	------

Compound	Two or more commands separated by a colon (:) with/without a parameter
----------	---

Example	SOURce:PULSe:WIDTh
---------	--------------------

Query	A query is a simple or compound command followed by a question mark (?). A parameter (data) is returned. The maximum or minimum value for a parameter can also be queried where applicable.
Example	SOURce1:FREQuency? SOURce1:FREQuency? MIN

Command forms Commands and queries have two different forms, long and short. The command syntax is written with the short form of the command in capitals and the remainder (long form) in lower case.

The diagram shows the command `SOURce1:DCOffset`. Brackets are drawn under `SOURce1` and `DCOffset`. Below the `SOURce1` bracket is the word "short". Above the `SOURce1` bracket is the word "long". Similarly, below the `DCOffset` bracket is the word "short", and above it is the word "long".

The commands can be written in capitals or lower-case, just so long as the short or long forms are complete. An incomplete command will not be recognized.

Below are examples of correctly written commands:

```
LONG  SOURce1:DCOffset
      SOURCE1:DCOFFSET
      source1:dcoffset
```

```
SHORT SOUR1:DCO
      sour1:dco
```

Command Format	$\text{SOURCE1:DCOffset} \underbrace{\langle \text{offset} \rangle}_{\text{LF}}$ <div style="display: flex; justify-content: center; gap: 20px; margin-top: -10px;"> 1 2 3 4 </div>	<p>1: command header</p> <p>2: single space</p> <p>3: parameter</p> <p>4: message terminator</p>
-------------------	---	--

Square Brackets [] Commands that contain squares brackets indicate that the contents are optional. The function of the command is the same with or without the square bracketed items. Brackets are not sent with the command.

For example, the frequency query below can use any of the following 3 forms:

SOURCE1:FREQUENCY? [MINimum|MAXimum]

SOURCE1:FREQUENCY? MAXimum

SOURCE1:FREQUENCY? MINimum

SOURCE1:FREQUENCY?

Braces {} Commands that contain braces indicate one item within the braces must be chosen. Braces are not sent with the command.

Angled Brackets <> Angle brackets are used to indicate that a value must be specified for the parameter. See the parameter description below for details. Angled brackets are not sent with the command.

Bars | Bars are used to separate multiple parameter choices in the command format.

Parameters	Type	Description	Example
	<Boolean>	Boolean logic	0, 1/ON,OFF
	<NR1>	integers	0, 1, 2, 3
	<NR2>	decimal numbers	0.1, 3.14, 8.5
	<NR3>	floating point	4.5e-1, 8.25e+1
	<NRf>	any of NR1, 2, 3	1, 1.5, 4.5e-1

	<NRf+> <Numeric>	NRf type with a suffix including MINimum, MAXimum or DEFault parameters.	1, 1.5, 4.5e-1 MAX, MIN,
	<aard>	Arbitrary ASCII characters.	
	<discrete>	Discrete ASCII character parameters	IMM, EXT, MAN
	<frequency> <peak deviation in Hz> <rate in Hz>	NRf+ type including frequency unit suffixes.	1 KHZ, 1.0 HZ, MHZ
	<amplitude>	NRf+ type including voltage peak to peak.	VPP
	<offset>	NRf+ type including volt unit suffixes.	V
	<seconds>	NRf+ type including time unit suffixes.	NS, S MS US
	<percent> <depth in percent>	NRf type	N/A
Message terminators	LF CR	line feed code (new line) and carriage return.	
	LF	line feed code (new line)	
	EOI	IEEE-488 EOI (End-Or-Identify)	
 Note	Λj or Λm should be used when using a terminal program.		

Command Separators	Space	A space is used to separate a parameter from a keyword/command header.
	Colon (:)	A colon is used to separate keywords on each node.
	Semicolon (;)	A semi colon is used to separate subcommands that have the same node level. For example: SOURce[1]:DCOffset? SOURce[1]:OUTPut? →SOURce1:DCOffset?;OUTPut?
	Colon + Semicolon (;:)	A colon and semicolon can be used to combine commands from different node levels. For example: SOURce1:PWM:SOURce? SOURce:PULSe:WIDTh? →SOURce1:PWM:SOURce?::SOURce:PULSe:WIDTh?
	Comma (,)	When a command uses multiple parameters, a comma is used to separate the parameters. For example: SOURce:APPLy:SQUare 10KHZ, 2.0 VPP, -1V

Command List

System Commands	196
SYSTem:ERRor?	196
*IDN?	196
*RST	197
*TST?	197
SYSTem:VERSion?	197
*OPC	198
*OPC?	198
*WAI	199
SYSTem:LANGuage	199
Status Register Commands	200
*CLS	200
*ESE	200
*ESR?	201
*STB?	201
*SRE	202
Interface Configuration Commands	203
SYSTem:INTerface	203
SYSTem:LOCal	203
SYSTem:REMote	203
Apply Commands	204
SOURce[1]:APPLY:SINusoid	206
SOURce[1]:APPLY:SQUare	206
SOURce[1]:APPLY:RAMP	207
SOURce[1]:APPLY:PULSe	207
SOURce[1]:APPLY:NOISe	208
SOURce[1]:APPLY:TRIangle	208
SOURce[1]:APPLY:DC	209
SOURce[1]:APPLY:USER	209
SOURce[1]:APPLY?	210
Output Commands	211
SOURce[1]:FUNction	211
SOURce[1]:FREQuency	212
SOURce[1]:AMPlitude	214
SOURce[1]:DCOffset	215
SOURce[1]:SQUare:DCYCle	216
SOURce[1]:RAMP:SYMMetry	217
OUTPut	218
OUTPut:LOAD	218
SOURce[1]:VOLTage:UNIT	219
Pulse Configuration Commands	221

SOURce[1]:PULSe:PERiod	221
SOURce[1]:PULSe:WIDTh	222
Amplitude Modulation (AM) Commands	223
AM Overview	223
SOURce[1]:AM:STATe	224
SOURce[1]:AM:SOURce	224
SOURce[1]:AM:INTernal:FUNction	225
SOURce[1]:AM:INTernal:FREQuency	225
SOURce[1]:AM:DEPTH	226
Frequency Modulation (FM) Commands	228
FM Overview	228
SOURce[1]:FM:STATe	229
SOURce[1]:FM:SOURce	229
SOURce[1]:FM:INTernal:FUNction	230
SOURce[1]:FM:INTernal:FREQuency	231
SOURce[1]:FM:DEVIation	231
Frequency-Shift Keying (FSK) Commands	233
FSK Overview	233
SOURce[1]:FSKey:STATe	233
SOURce[1]:FSKey:SOURce	234
SOURce[1]:FSKey:FREQuency	234
SOURce[1]:FSKey:INTernal:RATE	235
Pulse Width Modulation (PWM) Commands	236
PWM Overview	236
SOURce[1]:PWM:STATe	237
SOURce[1]:PWM:SOURce	237
SOURce[1]:PWM:INTernal:FUNction	238
SOURce[1]:PWM:INTernal:FREQuency	238
SOURce[1]:PWM:DUTY	239
Frequency Sweep Commands	241
Sweep Overview	241
SOURce[1]:SWEp:STATe	242
SOURce[1]:FREQuency:START	243
SOURce[1]:FREQuency:STOP	243
SOURce[1]:FREQuency:CENTer	244
SOURce[1]:FREQuency:SPAN	245
SOURce[1]:SWEp:SPACing	245
SOURce[1]:SWEp:TIME	246
SOURce[1]:SWEp:SOURce	247
OUTPut[1]:TRIGger:SLOPe	247
OUTPut[1]:TRIGger	248
SOURce[1]:MARKer:FREQuency	249
SOURce[1]:MARKer	250
Burst Mode Commands	251

Burst Mode Overview.....	251
SOURce[1]:BURSt:STATe	253
SOURce[1]:BURSt:MODE	253
SOURce[1]:BURSt:NCYCles	254
SOURce[1]:BURSt:INTernal:PERiod	255
SOURce[1]:BURSt:PHASe	256
SOURce[1]:BURSt:TRIGger:SOURce	256
SOURce[1]:BURSt:TRIGger:DELay	257
SOURce[1]:BURSt:TRIGger:SLOPe	258
SOURce[1]:BURSt:GATE:POLarity	259
SOURce[1]:BURSt:OUTPut:TRIGger:SLOPe	260
OUTPut:TRIGger	261
Arbitrary Waveform Commands	262
Arbitrary Waveform Overview	262
SOURce[1]:FUNCTion USER	263
DATA:DAC	263
SOURce[1]:ARB:EDIT:COPIY	264
SOURce[1]:ARB:EDIT:DELeTe	264
SOURce[1]:ARB:EDIT:DELeTe:ALL	265
SOURce[1]:ARB:EDIT:POINt	265
SOURce[1]:ARB:EDIT:LINE	266
SOURce[1]:ARB:EDIT:PROTect.....	266
SOURce[1]:ARB:EDIT:PROTect:ALL	266
SOURce[1]:ARB:EDIT:UNProtect.....	267
SOURce[1]:ARB:BUILt:SINusoid	267
SOURce[1]:ARB:BUILt:SQUare	267
SOURce[1]:ARB:BUILt:PULSe	268
SOURce[1]:ARB:BUILt:RAMP	269
SOURce[1]:ARB:BUILt:SINC	269
SOURce[1]:ARB:BUILt:EXPRise	270
SOURce[1]:ARB:BUILt:EXPFail	270
SOURce[1]:ARB:BUILt:DC.....	271
SOURce[1]:ARB:NCYCles	271
SOURce[1]:ARB:OUTPut:MARKer	272
SOURce[1]:ARB:OUTPut	272
Save and Recall Commands	273
*SAV	273
*RCL	273
MEMory:STATe:DELeTe.....	273
MEMory:STATe:DELeTe ALL	274

System Commands

SYSTem:ERRor?		System Query
Description	Reads an error from the error queue. See page 294 for details regarding the error queue.	
Query Syntax	SYSTem:ERRor?	
Return parameter	<string>	Returns an error string, <256 ASCII characters.
Example	SYSTem:ERRor? -138 Suffix not allowed Returns an error string.	

*IDN?		System Query
Description	Returns the function generator manufacturer, model number, serial number and firmware version number in the following format: GW INSTEK,AFG-3081,SN:XXXXXXXX,Vm.mm	
Query Syntax	IDN?	
Return parameter	<string>	
Example	*IDN? GW INSTEK,AFG-3081,SN:XXXXXXXX,Vm.mm Returns the identification of the function generator.	

***RST** System Command

Description Reset the function generator to its factory default state.

Note Note the *RST command will not delete instrument save states in memory.

Syntax ***RST**

***TST?** System Query

Description Performs a system self-test and returns a pass or fail judgment. An error message will be generated if the self test fails.

Note The error message can be read with the SYST:ERR? query.

Query Syntax ***TST?**

Return parameter	+0	Pass judgment
	+1	Fail judgment

Example ***TST?**
 +0
 The function generator passed the self-test.

SYSTem:VERSion? System Query

Description Performs a system version query. Returns a string with the instrument, firmware version, FPGA revision and bootloader.

Query Syntax **SYSTem:VERSion?**

Return parameter <string>

Example **SYST:VERS?**
 AFG-3000 VX.XXX_XXXX FPGA:XXXX
 BootLoad:XXXX

Returns the year (2010) and version for that year (1).

***OPC** System Command

Description This command sets the Operation Complete Bit (bit 0) of the Standard Event Status Register after the function generator has completed all pending operations. For the AFG-3000, the *OPC command is used to indicate when a sweep or burst has completed.

Note Before the OPC bit is set, other commands may be executed.

Syntax ***OPC**

***OPC?** System Query

Description Returns the OPC bit to the output buffer when all pending operations have completed. I.e. when the OPC bit is set.

Note Commands cannot be executed until the *OPC? query has completed.

Query Syntax ***OPC?**

Return parameter 1

Example ***OPC?**
1
 Returns a "1" when all pending operations are complete.

***WAI** System Command

Description	This command waits until all pending operations have completed before executing additional commands. I.e. when the OPC bit is set.
Note	This command is only used for triggered sweep and burst modes.
Syntax	*WAI

SYSTem:LANGUage System Command

Description	Sets or queries the display language. Select the language shown on the function generator front-panel display. Only one language can be enabled at a time. SYSTem:LANGUage? query returns "Chinese" or "English".				
Note	Only one language can be set.				
Syntax	SYSTem:LANGUage {CHINese ENGLISH}				
Example	SYST:LANG ENG Sets the display language to English.				
Query Syntax	SYSTem:LANGUage?				
Return Parameter	<table style="width: 100%; border-collapse: collapse;"> <tr> <td style="width: 30%; border-right: 1px solid black;">CHIN</td> <td>Chinese</td> </tr> <tr> <td style="border-right: 1px solid black;">ENG</td> <td>English</td> </tr> </table>	CHIN	Chinese	ENG	English
CHIN	Chinese				
ENG	English				
Query Example	SYST:LANG? ENG The current language is English.				

Status Register Commands

***CLS** System Command

Description The *CLS command clears all the event registers, the error queue and cancels an *OPC command.

Syntax ***CLS**

***ESE** System Command

Description The Standard Event Status Enable command determines which events in the Standard Event Status Event register can set the Event Summary Bit (ESB) of the Status Byte register. Any bit positions set to 1 enable the corresponding event. Any enabled events set bit 5 (ESB) of the Status Byte register.

Note The *CLS command clears the event register, but not the enable register.

Syntax ***ESE <enable value>**

Parameter <enable value> 0~255

Example ***ESE 20**
Sets a bit weight of 20 (bits 2 and 4).

Query Syntax ***ESE?**

Return Parameter	Bit	Register	Bit	Register
	0	Not used	4	Message Available
	1	Not used	5	Standard Event
	2	Error Queue	6	Master Summary
	3	Questionable Data	7	Not used

Example ***ESE?**
 4
 Bit 2 is set.

***ESR?** System Command

Description Reads and clears the Standard Event Status Register. The bit weight of the standard event status register is returned.

Note The *CLS will also clear the standard event status register.

Query Syntax ***ESR?**

Return Parameter	Bit	Register	Bit	Register
	0	Operation Complete	4	Execution Error
	1	Not Used	5	Command Error
	2	Query Error	6	Not Used
	3	Device Error	7	Power On

Query Example ***ESR?**
 5
 Returns the bit weight of the standard event status register (bit 0 and 2).

***STB?** System Command

Description Reads the Status byte condition register.

Note Bit 6, the master summary bit, is not cleared.

Syntax ***STB?**

***SRE** System Command

Description The Service Request Enable Command determines which events in the Status Byte Register are allowed to set the MSS (Master summary bit). Any bit that is set to "1" can cause the MSS bit to be set.

Note The *CLS command clears the status byte event register, but not the enable register.

Syntax ***SRE <enable value>**

Parameter <enable value> 0~255

Example ***SRE 12**

Sets a bit weight of 12 (bits 2 and 3) for the service request enable register.

Query Syntax ***SRE?**

Return Parameter	Bit	Register	Bit	Register
	0	Not used	4	Message Available
	1	Not used	5	Standard Event
	2	Error Queue	6	Master Summary
	3	Questionable Data	7	Not used

Query Example ***SRE?**
12

Returns the bit weight of the status byte enable register.

Interface Configuration Commands

SYSTem:INTErface System Command

Description Selects the remote interface. RS-232 is the factory default.

Note There is no interface query.

Syntax **SYSTem:INTErface {GPIB|RS232|USB}**

Example **SYST:INT USB**
Sets the interface to USB.

SYSTem:LOCal System Command

Description Sets the function generator to local mode. In local mode, all front panel keys are operational.

Syntax **SYSTem:LOCal**

Example **SYST:LOC**

SYSTem:REMote System Command

Description Disables the front panel keys and puts the function generator into remote mode (RS-232).

Syntax **SYSTem:REMote**

Example **SYST:REM**

Apply Commands

The APPLy command has 8 different types of outputs (Sine, Square, Ramp, Pulse, Noise, Triangle, DC, User). The command is the quickest, easiest way to output waveforms remotely. Frequency, amplitude and offset can be specified for each function.

As only basic parameters can be set with the Apply command, other parameters use the instrument default values.

The Apply command will set the trigger source to immediate and disable burst, modulation and sweep modes. Turns on the output command SOURce[1]:OUTP ON. The termination setting will not be changed.

As the frequency, amplitude and offset parameters are in nested square brackets, amplitude can only be specified if the frequency has been specified and offset can only be specified if amplitude has been set. For the example:

```
SOURce[1]:APPLY:SINusoid [<frequency> [,<amplitude>
[,<offset>] ]]
```

Output Frequency For the output frequency, MINimum, MAXimum and DEFault can be used. The default frequency for all functions is set to 1 kHz. The maximum and minimum frequency depends on the function used. If a frequency output that is out of range is specified, the max/min frequency will be used instead. A "Data out range error will be generated" from the remote terminal.

Output
Amplitude

When setting the amplitude, MINimum, MAXimum and DEFault can be used. The range depends on the function being used and the output termination (50Ω or high impedance). The default amplitude for all functions is 100 mVpp (50Ω).

If the amplitude has been set and the output termination is changed from 50Ω to high impedance, the amplitude will double. Changing the output termination from high impedance to 50Ω will half the amplitude.

Vrms, dBm or Vpp units can be used to specify the output unit to use with the current command. The VOLT:UNIT command can be used to set the units when no unit is specified with the Apply command. If the output termination is set to high impedance, dBm units cannot be used. The units will default to Vpp.

The output amplitude can be affected by the function and unit chosen. Vpp and Vrms or dBm values may have different maximum values due to differences such as crest factor. For example, a 5Vrms square wave must be adjusted to 3.536 Vrms for a sine wave.

DC Offset voltage The offset parameter can be set to MINimum, MAXimum or DEFault. The default offset is 0 volts. The offset is limited by the output amplitude as shown below.

$$|V_{offset}| < V_{max} - V_{pp}/2$$

If the output specified is out of range, the maximum offset will be set.

The offset is also determined by the output termination (50Ω or high impedance). If the offset has been set and the output termination has changed from 50Ω to high impedance, the offset will double. Changing the output termination from high impedance to 50Ω will half the offset.

SOURce[1]:APPLY:SINusoid		Source Specific Command
Description	Outputs a sine wave from the selected channel when the command has executed. Frequency, amplitude and offset can also be set.	
Syntax	SOURce[1]:APPLY:SINusoid [<frequency> [,<amplitude> [,<offset>]]]	
Parameter	<frequency>	1μHz~80MHz(3081)/50MHz(3051)
	<amplitude>	10mV~10V (50Ω) (3.536 Vrms)
	<offset>	0~4.99V (50Ω)
Example	SOUR1:APPL:SIN 2KHZ,MAX,MAX Sets frequency to 2kHz and sets the amplitude and offset to the maximum.	

SOURce[1]:APPLY:SQUare		Source Specific Command
Description	Outputs a square wave from the selected channel when the command has executed. Frequency, amplitude and offset can also be set. The duty cycle is set to 50%.	
Syntax	SOURce[1]:APPLY:SQUare [<frequency> [,<amplitude> [,<offset>]]]	
Parameter	<frequency>	1μHz~80MHz(3081)/50MHz(3051)
	<amplitude>	10mV~10V (50Ω)

	<code><offset></code>	0~4.99V (50Ω)
--	-----------------------------	---------------

Example **SOUR1:APPL:SQU 2KHZ,MAX,MAX**

Sets frequency to 2kHz and sets the amplitude and offset to the maximum.

SOURce[1]:APPLy:RAMP Source Specific Command

Description Outputs a ramp wave from the selected channel when the command has executed. Frequency, amplitude and offset can also be set. The symmetry is set to 100%.

Syntax **SOURce[1]:APPLy:RAMP [`<frequency>` [`<amplitude>` [`<offset>`]]]**

Parameter	<code><frequency></code>	1μHz~1MHz
	<code><amplitude></code>	10mV~10V (50Ω)
	<code><offset></code>	0~4.99V (50Ω)

Example **SOUR1:APPL:RAMP 2KHZ,MAX,MAX**

Sets frequency to 2kHz and sets the amplitude and offset to the maximum.

SOURce[1]:APPLy:PULSe Source Specific Command

Description Outputs a ramp wave from the selected channel when the command has executed. Frequency, amplitude and offset can also be set.

Note The PW settings from the SOURce[1]:PULS: WIDT command are preserved. Edge and pulse width may be adjusted to supported levels.

Repetition rates will be approximated from the frequency. For accurate repetition rates, the period should be adjusted using the SOURce[1]:PULS:PER command

Syntax **SOUR[1]:APPLy:PULSe [`<frequency>` [`<amplitude>` [`<offset>`]]]**

Parameter	<frequency>	500μHz~50MHz
	<amplitude>	10mV~10V (50Ω)
	<offset>	0~4.99V (50Ω)

Example **SOUR1:APPL:PULS 1KHZ,MIN,MAX**

Sets frequency to 1kHz and sets the amplitude to minimum and the and offset to the maximum.

SOURce[1]:APPLY:NOISe Source Specific Command

Description Outputs Gaussian noise with a 50 MHz bandwidth. Amplitude and offset can also be set.

Note Frequency cannot be used with the noise function; however a value (or DEFault) must be specified. The frequency is remembered for the next function used.

Syntax **SOURce[1]:APPLY:NOISe [<frequency>DEFault> [,<amplitude> [,<offset>]]]**

Parameter	<frequency>	Not applicable
	<amplitude>	10mV~10V (50Ω)
	<offset>	0~4.99V (50Ω)

Example **SOUR1:APPL:NOIS DEF, 3.0, 1.0**

Sets the amplitude to 3 volts with an offset of 1 volt.

SOURce[1]:APPLY:TRiangle Source Specific Command

Description Outputs a triangle wave from the selected channel when the command has executed. Frequency, amplitude and offset can also be set.

Syntax **SOURce[1]:APPLY:TRiangle [<frequency> [,<amplitude> [,<offset>]]]**

Parameter	<frequency>	1μHz~1MHz
	<amplitude>	10mV~10V (50Ω)

	<code><offset></code>	0~4.99V (50Ω)
--	-----------------------------	---------------

Example **SOUR1:APPL:TRI 2khz, 3.0, 1.0**

Sets the frequency to 1 MHz with an amplitude of 3 volts and with an offset of 1 volt.

SOURce[1]:APPLy:DC	Source Specific Command
---------------------------	----------------------------

Description Outputs a triangle wave from the selected channel when the command has executed. Frequency, amplitude and offset can also be set.

Note Frequency and amplitude cannot be used with the DC function; however a value (or DEFault) must be specified. The values are remembered for the next function used.

Syntax **SOUR[1]:APPLy:DC [<frequency|DEFault> [,<amplitude>|DEFault> [,<offset>]]]**

Parameter	<code><frequency></code>	Not applicable
	<code><amplitude></code>	Not applicable
	<code><offset></code>	±5V (50Ω), ±10V (open)

Example **SOUR1:APPL:DC DEF, DEF, 1.0**

Sets the DC offset to 1 volt.

SOURce[1]:APPLy:USER	Source Specific Command
-----------------------------	----------------------------

Description Outputs an arbitrary waveform from the selected channel. The output is that specified from the FUNC:USER command.

Note Frequency and amplitude cannot be used with the DC function; however a value (or DEFault) must be specified. The values are remembered for the next function used.

Syntax **SOURce[1]:APPLy:USER [<frequency> [,<amplitude> [,<offset>]]]**

Parameter	<frequency> <amplitude> <offset>	1μHz~100MHz 0~10V (50Ω) 0~5V (50Ω)
Example	SOUR1:APPL:USER	
		Source Specific Command
SOURce[1]:APPLY?		
Description	Outputs a string with the current settings.	
Note	The string can be passed back appended to the Apply Command.	
Syntax	SOURce[1]:APPLY?	
Return Parameter	<string>	Function, frequency, amplitude, offset
Example	SOUR1:APPL? SIN +5.000000000000E+03,+3.0000E+00,-2.50E+00 Returns a string with the current function and parameters, Sine, 5kHz, 3 Vpp, -2.5V offset.	

Output Commands

Unlike the Apply commands, the Output commands are low level commands to program the function generator.

This section describes the low-level commands used to program the function generator. Although the APPLY command provides the most straightforward method to program the function generator, the low-level commands give you more flexibility to change individual parameters.

	Source Specific Command
SOURce[1]:FUNction	
Description	The FUNCTION command selects and outputs the selected output. The User parameter outputs an arbitrary waveform previously set by the SOURce[1]:FUNC:USER command.
Note	<p>If the function mode is changed and the current frequency setting is not supported by the new mode, the frequency setting will be altered to next highest value.</p> <p>Vpp and Vrms or dBm amplitude values may have different maximum values due to differences such as crest factor. For example, if a 5Vrms square wave is changed to a sinewave, then the Vrms is automatically adjusted to 3.536.</p> <p>The modulation, burst and sweep modes can only be used with some of the basic waveforms. If a mode is not supported, the conflicting mode will be disabled. See the table below.</p>

	Sine	Squ	Tri	Ramp	Pulse	Noise	ARB
AM	✓	✓	✓	✓	✓	×	✓
FM	✓	✓	✓	✓	×	×	×
PWM	×	✓	×	×	×	×	×
FSK	✓	✓	✓	✓	✓	×	×
SWEEP	✓	✓	✓	✓	×	×	×
BRUST	✓	✓	✓	✓	×	×	×

Syntax **SOURce[1]:FUNction {SINusoid|SQUare|RAMP|PULSe|NOISe|TRIAnge|DC| USER}**

Example **SOUR1:FUNC SIN**
Sets the output as a sine function.

Query Syntax **SOURce[1]:FUNction?**

Return Parameter SIN, SQU, RAMP, PULS, NOIS, DC, TRI, USER Returns the current output type.

Example **SOUR1:FUNC?**
SIN
Current output is sine.

SOURce[1]:FREQuency Source Specific Command

Description Sets the output frequency for the SOURce[1]:FUNction command. The query command returns the current frequency setting.

Note The maximum and minimum frequency depends on the function mode.

Sine, Square	1μHz~80MHz(3081)/ 50MHz(3051)
Ramp, Triangle	1μHz~80MHz(3081)/ 50MHz(3051)
Pulse	50μHz~50MHz
Noise, DC	Not applicable

User 1μHz~100MHz

If the function mode is changed and the current frequency setting is not supported by the new mode, the frequency setting will be altered to next highest value.

The duty cycle of square waveforms depends on the frequency settings.

20% to 80% (*frequency* < 25 MHz)

40% to 60% (25 MHz < *frequency* < 50 MHz)

50% (*frequency* > 50 MHz)

If the frequency is changed and the set duty cycle cannot support the new frequency, the highest duty cycle available at that frequency will be used. A “settings conflict” error will result from the above scenario.

Syntax **SOURce[1]:FREQuency**
{<frequency>|MINimum|MAXimum}

Example **SOUR1:FREQ MAX**
Sets the frequency to the maximum for the current mode.

Query Syntax **SOURce[1]:FREQuency?**

Return Parameter <NR3> Returns the frequency for the current mode.

Example **SOUR1:FREQ? MAX**
+1.0000000000000E+03
The maximum frequency that can be set for the current function is 1MHz.

SOURce[1]:AMPlitude	Source Specific Command
Description	Sets the output amplitude for the SOURce[1]:FUNctIon command. The query command returns the current amplitude settings.
Note	<p>The maximum and minimum amplitude depends on the output termination. The default amplitude for all functions is 100 mVpp (50Ω). If the amplitude has been set and the output termination is changed from 50Ω to high impedance, the amplitude will double. Changing the output termination from high impedance to 50Ω will half the amplitude.</p> <p>The offset and amplitude are related by the following equation.</p> $ V_{offset} < V_{max} - V_{pp}/2$ <p>If the output termination is set to high impedance, dBm units cannot be used. The units will default to Vpp.</p> <p>The output amplitude can be affected by the function and unit chosen. Vpp and Vrms or dBm values may have different maximum values due to differences such as crest factor. For example, a 5Vrms square wave must be adjusted to 3.536 Vrms for a sine wave.</p> <p>The amplitude units can be explicitly used each time the SOURce[1]:AMPlitude command is used. Alternatively, the VOLT:UNIT command can be used to set the amplitude units for all commands.</p>
Syntax	SOURce[1]:AMPlitude {< amplitude> MINimum MAXimum}

Example **SOUR1:AMP MAX**
 Sets the amplitude to the maximum for the current mode.

Query Syntax **SOURce[1]:AMPlitude? {MINimum|MAXimum}**

Return Parameter <NR3> Returns the amplitude for the current mode.

Example **SOUR1:AMP? MAX**
 +5.0000E+00
 The maximum amplitude that can be set for the current function is 5 volts.

SOURce[1]:DCOffset Source Specific Command

Description Sets or queries the DC offset for the current mode.

Note
 The offset parameter can be set to MINimum, MAXimum or DEFault. The default offset is 0 volts. The offset is limited by the output amplitude as shown below.

$$|V_{offset}| < V_{max} - V_{pp}/2$$

If the output specified is out of range, the maximum offset will be set.
 The offset is also determined by the output termination (50Ω or high impedance). If the offset has been set and the output termination has changed from 50Ω to high impedance, the offset will double. Changing the output termination from high impedance to 50Ω will half the offset.

When trying to set a DC voltage, the SOURce[1]:FUNC DC should be used prior to setting an offset.

Syntax **SOURce[1]:DCOffset {< offset> |MINimum|MAXimum}**

Example	SOUR1:DCO MAX Sets the offset to the maximum for the current mode.
Query Syntax	SOURce[1]:DCOffset? {MINimum MAXimum}
Return Parameter	<NR3> Returns the offset for the current mode.
Example	SOUR1:DCO? +3.0000E+00 The offset for the current mode is set to +3 volts.

SOURce[1]:SQUare:DCYClE Source Specific Command

Description	Sets or queries the duty cycle for square waves only. The setting is remembered if the function mode is changed. The default duty cycle is 50%.
Note	The duty cycle of square waveforms depend on the frequency settings. 20% to 80% (<i>frequency < 25 MHz</i>) 40% to 60% (<i>25 MHz < frequency < 50 MHz</i>) 50% (<i>frequency > 50 MHz</i>) If the frequency is changed and the set duty cycle cannot support the new frequency, the highest duty cycle available at that frequency will be used. A "settings conflict" error will result from the above scenario. For square waveforms, the Apply command and AM/FM modulation modes ignore the duty cycle settings.

Syntax	SOURce[1]:SQUare:DCYClE {< percent> MINimum MAXimum}
--------	--

Example	SOUR1:SQU:DCYC MAX
---------	---------------------------

Sets the duty cycle to the highest possible for the current frequency.

Query Syntax **SOURce[1]:SQUare:DCYcle? {MINimum|MAXimum}**

Return Parameter <NR3> Returns the duty cycle as a percentage.

Example **SOUR1:SQU:DCYC?**
 +5.00E+01
 The duty cycle is set 50%.

SOURce[1]:RAMP:SYMMetry Source Specific Command

Description Sets or queries the symmetry for ramp waves only. The setting is remembered if the function mode is changed. The default symmetry is 50%.

Note For ramp waveforms, the Apply command and AM/FM modulation modes ignore the current symmetry settings.

Syntax **SOURce[1]:RAMP:SYMMetry {< percent> |MINimum|MAXimum}**

Example **SOUR[1]:RAMP:SYMM MAX**
 Sets the symmetry to the 100%.

Query Syntax **SOURce[1]:RAMP:SYMMetry? {MINimum|MAXimum}**

Return Parameter <NR3> Returns the symmetry as a percentage.

Example **SOUR1:RAMP:SYMMetry?**
 +1.0000E+02
 The symmetry is set as 100%.

OUTPut Source Specific Command

Description	Enables/Disables or queries the front panel output. The default is set to off.				
Note	<p>If the output is overloaded by an external voltage, the output will turn off and an error message will be displayed. The overload must first be removed before the output can be turned on again with output command.</p> <p>Using the Apply command automatically sets the front panel output to on.</p>				
Syntax	OUTPut {OFF ON}				
Example	<p>OUTP ON</p> <p>Turns the output on.</p>				
Query Syntax	OUTPut?				
Return Parameter	<table border="1"> <tr> <td>1</td> <td>ON</td> </tr> <tr> <td>0</td> <td>OFF</td> </tr> </table>	1	ON	0	OFF
1	ON				
0	OFF				
Example	<p>OUTP?</p> <p>1</p> <p>The output is currently on.</p>				

OUTPut:LOAD Source Specific Command

Description	<p>Sets or queries the output termination. Two impedance settings can be chosen, DEFault (50Ω) and INFinity (high impedance >10 kΩ).</p> <p>The output termination is to be used as a reference only. If the output termination is set 50Ω but the actual load impedance is not 50Ω, then the amplitude and offset will not be correct.</p>
Note	<p>If the amplitude has been set and the output termination is changed from 50Ω to high impedance, the amplitude will double. Changing</p>

	the output termination from high impedance to 50Ω will half the amplitude.
	If the output termination is set to high impedance, dBm units cannot be used. The units will default to Vpp.
Syntax	OUTPut:LOAD {DEFault INFinity}
Example	OUTP:LOAD DEF Sets the output termination to 50Ω.
Query Syntax	OUTPut:LOAD?
Return Parameter	DEF Default INF INFinity
Example	OUTP:LOAD? DEF The output is set to the default of 50Ω.

	Source Specific Command
SOURce[1]:VOLTage:UNIT	
Description	Sets or queries the output amplitude units. There are three types of units: VPP, VRMS and DBM.
Note	The units set with the VOLTage:UNIT command will be used as the default unit for all amplitude units unless a different unit is specifically used for a command. If the output termination is set to high impedance, dBm units cannot be used. The Units will automatically default to Vpp.
Syntax	SOURce[1]:VOLTage:UNIT {VPP VRMS DBM}
Example	SOUR1:VOLT:UNIT VPP Sets the amplitude units to Vpp.
Query Syntax	SOURce[1]:VOLTage:UNIT?
Return Parameter	VPP Vpp VRMS Vrms

	DBM	dBm
Example	SOUR1:VOLT:UNIT? VPP The amplitude units are set to Vpp.	

Pulse Configuration Commands

The pulse chapter is used to control and output pulse waveforms. Unlike the APPLy command, low level control is possible including setting the rise time, fall time, period and pulse width.

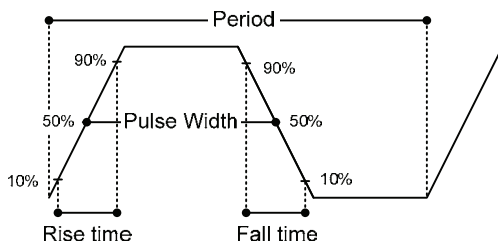

	Source Specific Command
	SOURce[1]:PULSe:PERiod
Description	Sets or queries the pulse period. The default period is 1 ms.
Note	<p>The pulse period must be greater than the pulse width and edge time(1.6x) combined.</p> <p>$Pulse\ Width + (1.6 * Edge\ Time) < Period$</p> <p>If the edge time or pulse width are too great, they will automatically be reduced to fit the period by the function generator.</p> <p>The PULSe:PERiod function will change the period for all functions, not just for the pulse waveforms. If a different function is chosen and the current period is out of range, the period will be automatically adjusted to suit the new function.</p>
Syntax	SOURce[1]:PULSe:PERiod {<seconds> MINimum MAXimum}
Example	SOUR1:PULS:PER MIN Sets the period to the minimum time allowed.
Query Syntax	SOURce[1]:PULSe:PERiod? [MINimum MAXimum]
Return Parameter	<seconds> 20 ns ~ 2000 seconds

Example **SOUR1:PULS:PER?**
 +1.0000E+01
 The period is set to 10 seconds.

SOURce[1]:PULSe:WIDTh	Source Specific Command
-----------------------	-------------------------

Description	<p>Sets or queries the pulse width. The default pulse width is 100us.</p> <p>The minimum pulse width is affected by the period time. If the period is over 20 or 200 seconds, then the minimum pulse width is 1us and 10us, respectively.</p> <p>Pulse width is defined as the time from the rising to falling edges (at a threshold of 50%).</p>
-------------	---

Note	<p>The pulse width cannot be less than the edge time times 1.6.</p> <p>$Pulse\ Width > 1.6 * Edge\ Time$</p> <p>The pulse width must be less than the period minus the edge time (x1.6).</p> <p>$Pulse\ Width < Period - (1.6 * Edge\ Time)$</p>
------	--

Syntax	SOURce[1]:PULSe:WIDTh {<seconds> MINimum MAXimum}
--------	--

Example	<p>SOUR1:PULS:WIDTh MAX</p> <p>Sets the pulse width to the maximum allowed.</p>
---------	--

Query Syntax	SOURce[1]:PULSe:WIDTh? [MINimum MAXimum]
--------------	---

Return Parameter	<seconds> 8 ns ~ 2000 seconds
------------------	--

Example	<p>SOUR1:PULS:WIDTh? MIN</p> <p>+8.0000E-09</p> <p>The pulse width is set to 8 nanoseconds.</p>
---------	--

Amplitude Modulation (AM) Commands

AM Overview

To successfully create an AM waveform, the following commands must be executed in order.

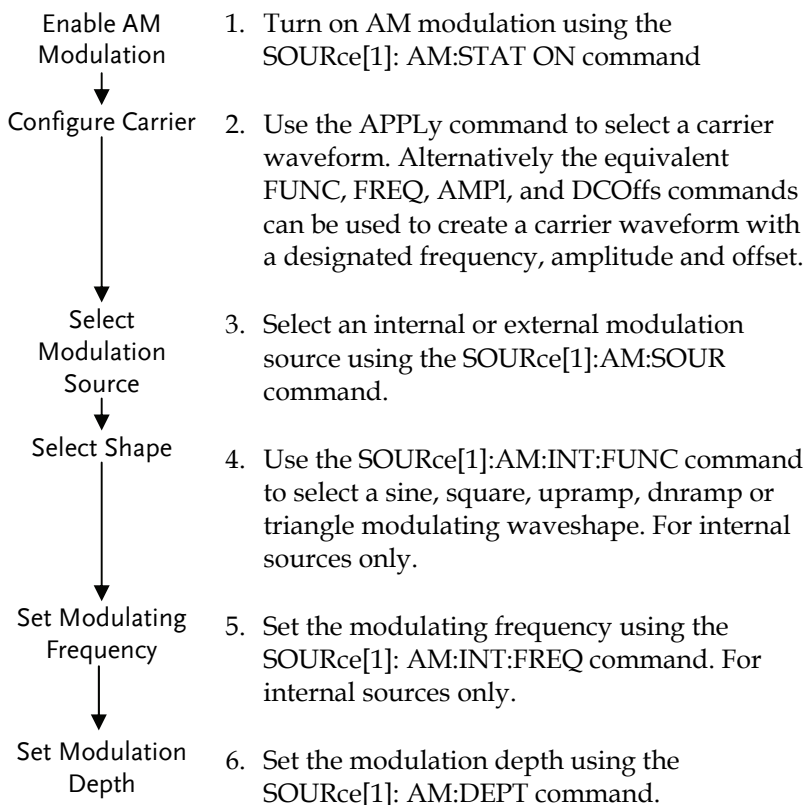

SOURce[1]:AM:STATe		Source Specific Command
Description	Sets or disables AM modulation. By default AM modulation is disabled. AM modulation must be enabled before setting other parameters.	
Note	Burst or sweep mode will be disabled if AM modulation is enabled. As only one modulation is allowed at any one time, other modulation modes will be disabled when AM modulation is enabled.	
Syntax	SOURce[1]:AM:STATe {OFF ON}	
Example	SOUR1:AM:STAT ON Enables AM modulation.	
Query Syntax	SOURce[1]:AM:STATe?	
Return Parameter	0	Disabled (OFF)
	1	Enabled (ON)
Example	SOUR1:AM:STAT? 1 AM modulation mode is currently enabled.	

SOURce[1]:AM:SOURce		Source Specific Command
Description	Sets or queries the modulation source as internal or external. Internal is the default modulation source.	
Note	If an external modulation source is selected, modulation depth is limited to $\pm 5V$ from the MOD INPUT terminal on the rear panel. For example, if modulation depth is set to 100%, then the maximum amplitude is +5V, and the minimum amplitude is -5V.	
Syntax	SOURce[1]:AM:SOURce {INTernal EXTernal}	
Example	SOUR1:AM:SOUR EXT	

Sets the modulation source to external.

Query Syntax **SOURce[1]:AM:SOURce?**

Return Parameter	INT	Internal
	EXT	External

Example **SOUR1:AM:SOUR?**
INT

The modulation source is set to internal.

SOURce[1]:AM:INTernal:FUNCtion Source Specific Command

Description Sets the shape of the modulating waveform from sine, square, triangle, upramp and dn ramp. The default shape is sine.

Note Square and triangle waveforms have a 50% duty cycle. Upramp and dn ramp have a symmetry of 100% and 0%, respectively.

Syntax **SOURce[1]:AM:INTernal:FUNCtion {SINusoid|SQUare|TRIangle|UPRamp|DNRamp}**

Example **SOUR1:AM:INT:FUNC SIN**
Sets the AM modulating wave shape to sine.

Query Syntax **SOURce[1]:AM:INTernal:FUNCtion?**

Return Parameter	SIN	Sine	UPRAMP	Upramp
	SQU	Square	DNRAMP	Dn ramp
	TRI	Triangle		

Example **SOUR1:AM:INT:FUNC?**
SIN
The shape for the modulating waveform is Sine.

SOURce[1]:AM:INTernal:FREQency Source Specific Command

Description Sets the frequency of the internal modulating waveform only. The default frequency is 100Hz.

Syntax	SOURce[1]:AM:INTernal:FREQuency {<frequency> MINimum MAXimum}	
Parameter	<frequency>	2 mHz~ 20 kHz
Example	SOUR1:AM:INT:FREQ +1.0000E+02 Sets the modulating frequency to 100Hz.	
Query Syntax	SOURce[1]:AM:INTernal:FREQuency? [MINimum MAXimum]	
Return Parameter	<NR3>	Returns the frequency in Hz.
Example	SOUR1:AM:INT:FREQ? MIN +1.0000E+02 Returns the minimum frequency allowed.	

SOURce[1]:AM:DEPT Source Specific Command

Description	Sets or queries the modulation depth for internal sources only. The default is 100%.	
Note	The function generator will not output more than $\pm 5V$, regardless of the modulation depth. The modulation depth of an external source is controlled using the $\pm 5V$ MOD INPUT terminal on the rear panel, and not the SOURce[1]:AM:DEPT command.	
Syntax	SOURce[1]:AM:DEPT {<depth in percent> [MINimum MAXimum]	
Parameter	<depth in percent>	0~120%
Example	SOUR1:AM:DEPT 50 Sets the modulation depth to 50%.	
Query Syntax	SOURce[1]:AM:DEPT? [MINimum MAXimum]	
Return Parameter	<NR3>	Return the modulation depth as a percentage.

Example

SOUR1:AM:DEPT?

+1.0000E+02

The modulation depth is 100%.

Frequency Modulation (FM) Commands

FM Overview

The following is an overview of the steps required to generate an FM waveform.

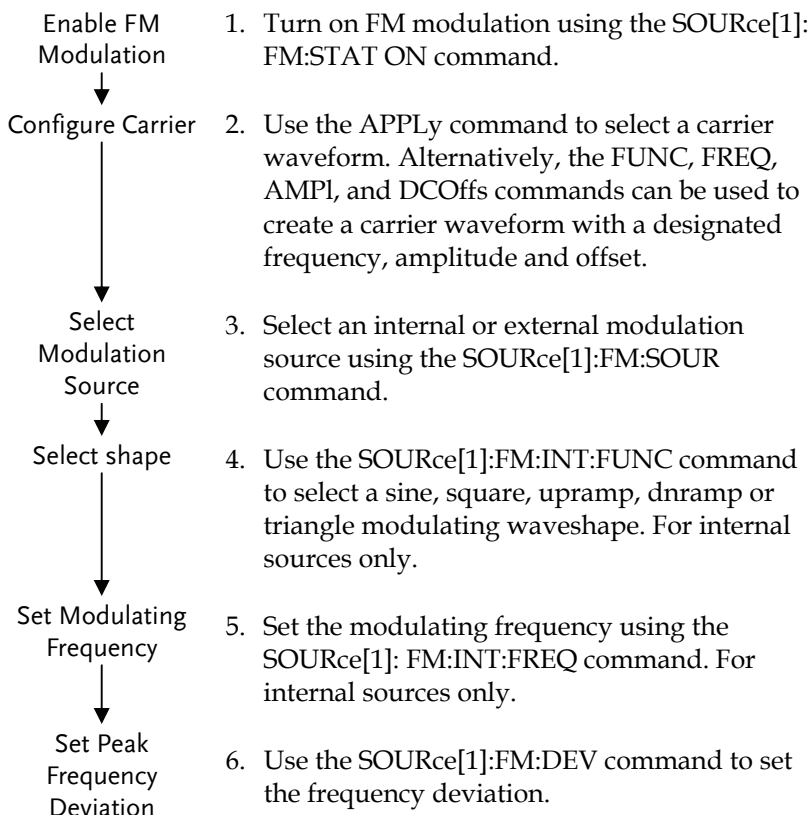

SOURce[1]:FM:STATe Source Specific Command

Description Sets or disables FM modulation. By default FM modulation is disabled. FM modulation must be enabled before setting other parameters.

Note Burst or sweep mode will be disabled if FM modulation is enabled. As only one modulation is allowed at any one time, other modulation modes will be disabled when FM modulation is enabled.

Syntax **SOUR[1]:FM:STATe {OFF|ON}**

Example **SOUR1:FM:STAT ON**
Enables FM modulation.

Query Syntax **SOURce[1]:FM:STATe?**

Return Parameter	0	Disabled (OFF)
-------------------------	----------	----------------

	1	Enabled (ON)
--	----------	--------------

Example **SOUR1:FM:STAT?**
1
FM modulation mode is currently enabled.

SOURce[1]:FM:SOURce Source Specific Command

Description Sets or queries the modulation source as internal or external. Internal is the default modulation source.

Note If an external modulation source is selected, modulation depth is limited to $\pm 5V$ from the MOD INPUT terminal on the rear panel. For example, if modulation depth is set to 100%, then the maximum amplitude is +5V, and the minimum amplitude is -5V.

Syntax **SOURce[1]:FM:SOURce {INTernal|EXTernal}**

Example **SOUR1:FM:SOUR EXT**
 Sets the modulation source to external.

Query Syntax **SOURce[1]:FM:SOURce?**

Return Parameter	INT	Internal
	EXT	External

Example **SOUR1:FM:SOUR?**
INT
 The modulation source is set to internal.

SOURce[1]:FM:INTernal:FUNcTion Source Specific Command

Description Sets the shape of the modulating waveform from sine, square, triangle, upramp and dn ramp. The default shape is sine.

Note Square and triangle waveforms have a 50% duty cycle. Upramp and dn ramp have a symmetry of 100% and 0%, respectively.

Syntax **SOURce[1]:FM:INTernal:FUNcTion**
{SINusoid|SQUare|TRIangle|UPRamp|DNRamp}

Example **SOUR1:FM:INT:FUNC SIN**
 Sets the FM modulating wave shape to sine.

Query Syntax **SOURce[1]:FM:INTernal:FUNcTion?**

Return Parameter	SIN	Sine	UPRAMP	Upramp
	SQU	Square	DNRAMP	Dn ramp
	TRI	Triangle		

Example **SOUR1:FM:INT:FUNC?**
SIN
 The shape for the modulating waveform is Sine.

SOURce[1]:FM:INTernal:FREQuency Source Specific Command

Description	Sets the frequency of the internal modulating waveform only. The default frequency is 10Hz.	
Syntax	SOURce[1]:FM:INTernal:FREQuency {<frequency> MINimum MAXimum}	
Parameter	<frequency>	2 mHz~ 20 kHz
Example	SOUR1:FM:INT:FREQ +1.0000E+02 Sets the modulating frequency to 100Hz.	
Query Syntax	SOURce[1]:FM:INTernal:FREQuency? [MINimum MAXimum]	
Return Parameter	<NR3>	Returns the frequency in Hz.
Example	SOUR1:FM:INT:FREQ? MAX +2.0000E+04 Returns the maximum frequency allowed.	

SOURce[1]:FM:DEVIation Source Specific Command

Description	Sets or queries the peak frequency deviation of the modulating waveform from the carrier waveform. The default peak deviation is 100Hz. The frequency deviation of external sources is controlled using the ±5V MOD INPUT terminal on the rear panel. A positive signal (>0~+5V) will increase the deviation (up to the set frequency deviation), whilst a negative voltage will reduce the deviation.	
Note	The relationship of peak deviation to modulating frequency and carrier frequency is shown below. Peak deviation = modulating frequency - carrier frequency. The carrier frequency must be greater than or	

equal to the peak deviation frequency. The sum of the deviation and carrier frequency must not exceed the maximum frequency for a specific carrier shape. If an out of range deviation is set for any of the above conditions, the deviation will be automatically adjusted to the maximum value allowed and an “out of range” error will be generated.

For square wave carrier waveforms, the deviation may cause the duty cycle frequency boundary to be exceeded. In these conditions the duty cycle will be adjusted to the maximum allowed and a “settings conflict” error will be generated.

Syntax	SOURce[1]:FM:DEVIation {<peak deviation in Hz> MINimum MAXimum}	
Parameter	<peak deviation in Hz>	DC~80MHz(3081)/ 50MHz(3051) DC~1MHz (Ramp)
Example	SOUR1:FM:DEV MAX Sets the frequency deviation to the maximum value allowed.	
Query Syntax	SOURce[1]:FM:DEVIation? [MINimum MAXimum]	
Return Parameter	<NR3>	Returns the frequency deviation in Hz.
Example	SOURce[1]:FM:DEVIation? MAX +8.0000E+04 The maximum frequency deviation for the current function is 80MHz.	

Frequency-Shift Keying (FSK) Commands

FSK Overview

The following is an overview of the steps required to generate an FSK modulated waveform.

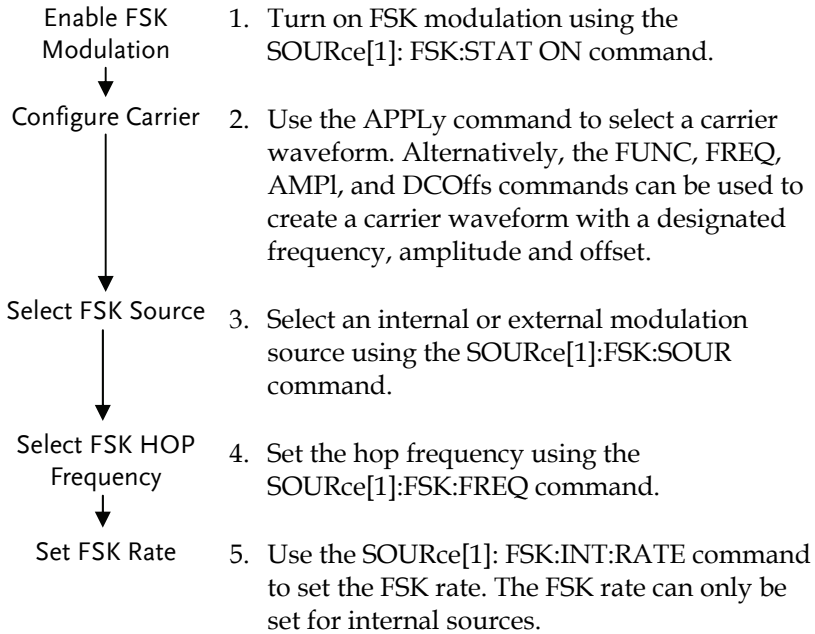

SOURCE[1]:FSKey:STATe		Source Specific Command
Description	Turns FSK Modulation on or off. By default FSK modulation is off.	
Note	Burst or sweep mode will be disabled if FSK modulation is enabled. As only one modulation is allowed at any one time, other modulation modes will be disabled when FSK modulation is enabled.	
Syntax	SOURCE[1]:FSKey:STATe {OFF ON}	

Example **SOUR1:FSK:STAT ON**
 Enables FSK modulation

Query Syntax **SOURce[1]:FSKey:STATe?**

Return Parameter	0	Disabled (OFF)
	1	Enabled (ON)

Example **SOUR1:FSK:STAT?**
ON
 FSK modulation is currently enabled.

SOURce[1]:FSKey:SOURce Source Specific Command

Description Sets or queries the FSK source as internal or external. Internal is the default source.

Note If an external FSK source is selected, FSK rate is controlled by the Trigger INPUT terminal on the rear panel.

Syntax **SOURce[1]:FSKey:SOURce {INTernal|EXTernal}**

Example **SOUR1:FSK:SOUR EXT**
 Sets the FSK source to external.

Query Syntax **SOURce[1]:FSKey:SOURce?**

Return Parameter	INT	Internal
	EXT	External

Example **SOUR1:FSK:SOUR?**
INT
 The FSK source is set to internal.

SOURce[1]:FSKey:FREQuency Source Specific Command

Description Sets the FSK hop frequency. The default hop frequency is set to 100Hz.

Note	For FSK, the modulating waveform is a square wave with a duty cycle of 50%.	
Syntax	SOURce[1]:FSKey:FREQuency {<frequency> MINimum MAXimum}	
Parameter	<frequency>	1 μHz~ 80 MHz(3081)/ 50MHz(3051)
Example	SOUR1:FSK:FREQ +1.0000E+02 Sets the FSK hop frequency to to 100Hz.	
Query Syntax	SOURce[1]:FSKey:FREQuency? [MINimum MAXimum]	
Return Parameter	<NR3>	Returns the frequency in Hz.
Example	SOUR1:FSK:FREQ? MAX +8.0000E+07 Returns the maximum hop frequency allowed.	

SOURce[1]:FSKey:INTernal:RATE Source Specific Command

Description	Sets or queries the FSK rate for internal sources only.	
Note	External sources will ignore this command.	
Syntax	SOURce[1]:FSKey:INTernal:RATE {<rate in Hz> MINimum MAXimum}	
Parameter	<rate in Hz>	2 mHz~100 kHz
Example	SOUR1:FSK:INT:RATE MAX Sets the rate to the maximum (100kHz).	
Query Syntax	SOURce[1]:FSKey:INTernal:RATE? [MINimum MAXimum]	
Return Parameter	<NR3>	Returns the FSK rate in Hz.
Example	SOUR1:FSK:INT:RATE? MAX +1.0000E+05	

Returns the maximum FSK rate allowed.

Pulse Width Modulation (PWM) Commands

PWM Overview

The following is an overview of the steps required to generate a PWM modulated waveform.

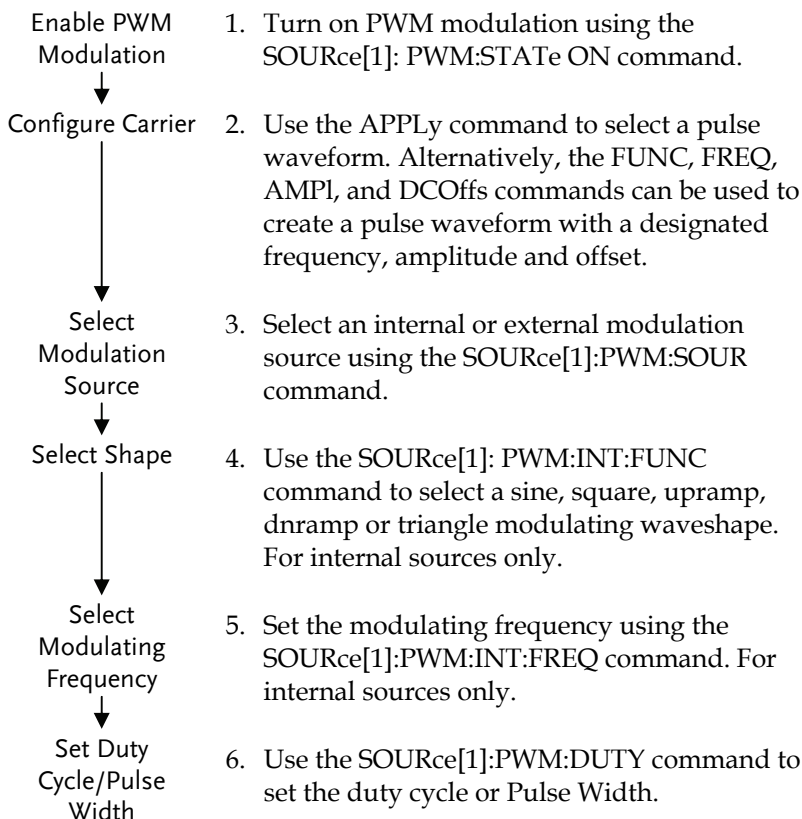

SOURce[1]:PWM:STATe Source Specific Command

Description	Turns FSK Modulation on or off. By default FSK modulation is off.	
Note	Burst or sweep mode will be disabled if PWM modulation is enabled. As only one modulation is allowed at any one time, other modulation modes will be disabled when FSK modulation is enabled.	
Syntax	SOURce[1]:PWM:STATe {OFF ON}	
Example	SOUR1:PWM:STAT ON Enables PWM modulation	
Query Syntax	SOURce[1]:PWM:STATe?	
Return Parameter	0	Disabled (OFF)
	1	Enabled (ON)
Example	SOUR1:PWM:STAT? ON FSK modulation is currently enabled.	

SOURce[1]:PWM:SOURce Source Specific Command

Description	Sets or queries the PWM source as internal or external. Internal is the default source.	
Note	If an external PWM source is selected, the duty cycle/pulse width is controlled by the MOD INPUT terminal on the rear panel.	
Syntax	SOURce[1]:PWM:SOURce {INTernal EXTernal}	
Example	SOUR1:PWM:SOUR EXT Sets the PWM source to external.	
Query Syntax	SOURce[1]:PWM:SOURce?	
Return Parameter	INT	Internal
	EXT	External

Example **SOUR1:PWM:SOUR?**
INT
 The PWM source is set to internal.

SOURce[1]:PWM:INTernal:FUNction Source Specific Command

Description Sets the shape of the modulating waveform from sine, square, triangle, upramp and dn ramp. The default shape is sine.

Note Square and triangle waveforms have a 50% duty cycle. Upramp and dn ramp have a symmetry to 100% and 0%, respectively.
 Carrier must be a pulse or PWM waveform.

Syntax **SOURce[1]:PWM:INTernal:FUNction**
{SINusoid|SQUare|TRIangle|UPRamp|DNRamp}

Example **SOUR1:PWM:INT:FUN SIN**
 Sets the PWM modulating wave shape to sine. .

Query Syntax **SOURce[1]:PWM:INTernal:FUNction?**

Return Parameter	SIN	Sine	UPRAMP	Upramp
	SQU	Square	DNRAMP	Dn ramp
	TRI	Triangle		

Example **SOUR1:PWM:INT:FUN?**
SIN
 The shape for the modulating waveform is Sine.

SOURce[1]:PWM:INTernal:FREQuency Source Specific Command

Description Sets the modulating waveform frequency for internal sources. The default frequency is set to 10Hz.

Syntax **SOURce[1]:PWM:INTernal:FREQuency**
{<frequency>|MINimum|MAXimum}

Parameter	<frequency>	2 mHz~ 20 kHz
Example	SOUR1:PWM:INT:FREQ MAX Sets the frequency to the maximum value.	
Query Syntax	SOURce[1]:PWM:INTernal:FREQuency?	
Return Parameter	<NR3>	Returns the frequency in Hz.
Example	SOUR1:PWM:INT:FREQ? MAX +2.0000E+04 Returns the modulating frequency. (20kHz)	

SOURce[1]:PWM:DUTY Source Specific Command

Description	Sets or queries the duty cycle deviation. The default duty cycle is 50%.	
Note	<p>The duty cycle is limited by period, edge time and minimum pulse width.</p> <p>The duty cycle deviation of an external source is controlled using the $\pm 5V$ MOD INPUT terminal on the rear panel. A positive signal ($>0\sim+5V$) will increase the deviation (up to the set duty cycle deviation), whilst a negative voltage will reduce the deviation.</p>	
Syntax	SOURce[1]:PWM:DUTY {< percent> minimum maximum}	
Parameter	<percent>	0%~100% (limited, see above)
Example	SOUR1:PWM:DUTY +3.0000E+01 Sets the duty cycle to 30%.	
Query Syntax	SOURce[1]:PWM:DUTY?	
Return Parameter	<NR3>	Returns the deviation in %.

Example

SOUR1:PWM:DUTY?

+3.0000E+01

The current duty cycle is 30%.

Frequency Sweep Commands

Sweep Overview

Below shows the order in which commands must be executed to perform a sweep.

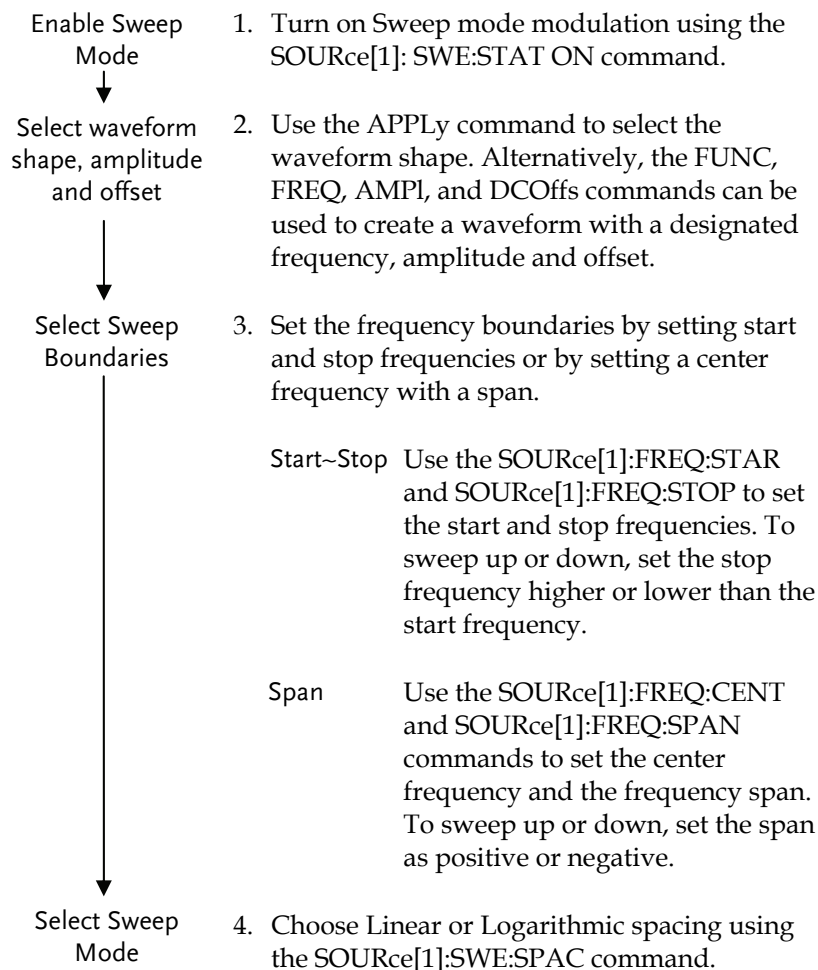

- | | |
|--------------------------------------|--|
| Select Sweep Time
↓ | 5. Choose the sweep time using the SOURce[1]:SWE:TIME command. |
| Select the sweep trigger source
↓ | 6. Select an internal or external sweep trigger source using the SOURce[1]:SOUR command. |
| Select the marker frequency | 7. To output a marker frequency from the SYNC terminal, use The SOURce[1]:MARK:FREQ command. To enable marker frequency output, use the SOURce[1]:MARK ON command. |

The marker frequency can be set to a value within the sweep span.

SOURce[1]:SWEep:STATe		Source Specific Command
Description	Sets or disables Sweep mode. By default Sweep is disabled. FM modulation must be enabled before setting other parameters.	
Note	Any modulation modes or Burst mode will be disabled if sweep mode is enabled.	
Syntax	SOURce[1]:SWEep:STATe {OFF ON}	
Example	SOUR1:SWE:STAT ON Enables sweep mode.	
Query Syntax	SOURce[1]:SWEep:STATe?	
Return Parameter	0	Disabled (OFF)
	1	Enabled (ON)
Example	SOUR1:SWE:STAT? 1 Sweep mode is currently enabled.	

SOURce[1]:FREQuency:STARt Source Specific Command

Description Sets the start frequency of the sweep. 100Hz is the default start frequency.

Note To sweep up or down, set the stop frequency higher or lower than the start frequency.

Syntax **SOURce[1]:FREQuency:STARt**
{<frequency>|MINimum|MAXimum}

Parameter <frequency> 100μHz~ 80MHz(3081)/
 50MHz(3051)
 100μHz~ 1MHz (Ramp)

Example **SOUR1:FREQ:STAR +2.0000E+03**
 Sets the start frequency to 2kHz.

Query Syntax **SOURce[1]:FREQuency:STARt? [MINimum|MAXimum]**

Return Parameter <NR3> Returns the start frequency in Hz.

Example **SOUR1:FREQ:STAR? MAX**
+8.0000E+07
 Returns the maximum start frequency allowed.

SOURce[1]:FREQuency:STOP Source Specific Command

Description Sets the stop frequency of the sweep. 1 kHz is the default start frequency.

Note To sweep up or down, set the stop frequency higher or lower than the start frequency.

Syntax **SOURce[1]:FREQuency:STOP**
{<frequency>|MINimum|MAXimum}

Parameter <frequency> 100μHz~ 80MHz(3081)/
 50MHz(3051)
 100μHz~ 1MHz (Ramp)

Example	SOUR1:FREQ:STOP +2.0000E+03 Sets the stop frequency to 2kHz.	
Query Syntax	SOURce[1]:FREQuency:STOP? [MINimum] MAXimum]	
Return Parameter	<NR3>	Returns the stop frequency in Hz.
Example	SOUR1:FREQ:STOP? MAX +8.0000E+07 Returns the maximum stop frequency allowed.	

SOURce[1]:FREQuency:CENTer Source Specific Command

Description	Sets and queries the center frequency of the sweep. 550 Hz is the default center frequency.	
Note	The maximum center frequency depends on the sweep span and maximum frequency: $\text{max center freq} = \text{max freq} - \text{span} / 2$	
Syntax	SOURce[1]:FREQuency:CENTer {<frequency> MINimum MAXimum}	
Parameter	<frequency>	100μHz~ 80MHz(3081)/ 50MHz(3051) 100μHz~ 1MHz (Ramp)
Example	SOUR1:FREQ:CENT +2.0000E+03 Sets the center frequency to 2kHz.	
Query Syntax	SOURce[1]:FREQuency:CENTer? [MINimum] MAXimum]	
Return Parameter	<NR3>	Returns the stop frequency in Hz.
Example	SOUR1:FREQ:CENT? MAX +8.0000E+06 Returns the maximum center frequency allowed, depending on the span.	

SOURce[1]:FREQuency:SPAN Source Specific Command

Description Sets and queries the frequency span of the sweep. 900 Hz is the default frequency span. The span frequency is equal to the stop-start frequencies.

Note To sweep up or down, set the span as positive or negative.
 The maximum span frequency has a relationship to the center frequency and maximum frequency:
 $\text{max freq span} = 2(\text{max freq} - \text{center freq})$

Syntax **SOURce[1]:FREQuency:SPAN {<frequency>|MINimum|MAXimum}**

Parameter <frequency> 100μHz~ 80MHz(3081)/50MHz(3051)100μHz~1MHz (Ramp)

Example **SOUR1:FREQ:SPAN +2.0000E+03**
 Sets the frequency span to 2kHz.

Query Syntax **SOURce[1]:FREQuency:SPAN? [MINimum|MAXimum]**

Return Parameter <NR3> Returns the frequency span in Hz.

Example **SOUR1:FREQ:SPAN? +2.0000E+03**
 Returns the frequency span for the current sweep.

SOURce[1]:SWEep:SPACing Source Specific Command

Description Sets linear or logarithmic sweep spacing. The default spacing is linear.

Syntax **SOURce[1]:SWEep:SPACing {LINear|LOGarithmic}**

Example **SOUR1:SWE:SPAC LIN**
 Sets the spacing to linear.

Query Syntax	SOURce[1]:SWEep:SPACing?	
Return Parameter	LIN	Linear spacing
	LOG	Logarithmic spacing

Example **SOUR1:SWE:SPAC?**
LOG
 The spacing is currently set as linear.

SOURce[1]:SWEep:TIME Source Specific Command

Description Sets or queries the sweep time. The default sweep time is 1 second.

Note The function generator automatically determines the number of frequency points that are used for the sweep based on the sweep time.

Syntax **SOURce[1]:SWEep:TIME**
{<seconds>|MINimum|MAXimum}

Parameter <seconds> 1 ms ~ 500 s

Example **SOUR1:SWE:TIME +1.0000E+00**
 Sets the sweep time to 1 second.

Query Syntax **SOURce[1]:SWEep:TIME? {<seconds>|MINimum|MAXimum}**

Return Parameter <NR3> Returns sweep time in seconds.

Example **SOUR1:SWE:TIME?**
+2.0000E+01
 Returns the sweep time (20 seconds).

SOURce[1]:SWEep:SOURce Source Specific Command

Description Sets or queries the trigger source as immediate (internal), external or manual. Immediate (internal) is the default trigger source. IMMEDIATE will constantly output a swept waveform. EXTERNAL will output a swept waveform after each external trigger pulse. Manual will output a swept waveform after the trigger softkey is pressed.

Note If the APPLY command was used to create the waveform shape, the source is automatically set to IMMEDIATE.
The *OPC/*OPC? command/query can be used to signal the end of the sweep.

Syntax **SOURce[1]: SWEep:SOURce {IMMEDIATE|EXTERNAL|MANUAL}**

Example **SOUR1: SWE:SOUR EXT**
Sets the sweep source to external.

Query Syntax **SOURce[1]: SWEep:SOURce?**

Return Parameter	IMM	Immediate
	EXT	External
	MANual	Manual

Example **SOUR1:SWE:SOUR?**
IMM
The sweep source is set to immediate.

OUTPut[1]:TRIGger:SLOPe Source Specific Command

Description Configures the trigger output signal (TTL) as a positive or negative slope. A positive slope will output a pulse with a rising edge and a negative slope will output a pulse with a falling edge.

Note The Trig out signal depends on the selected trigger source.

Trigger Source	Description
Immediate	A square wave is output from the Trig out terminal with a 50% duty cycle at the start of every sweep.
External	Trigger Output is disconnected.
Manual	A pulse (>1 us) is output from the Trig out terminal at the start of each sweep.

Syntax **OUTPut[1]:TRIGger:SLOPe {POSitive|NEGative}**

Example **OUTP1:TRIG:SLOP NEG**
Sets the Trig out signal as negative edge.

Query Syntax **OUTPut[1]:TRIGger:SLOPe?**

Return Parameter	POS	Positive edge
	NEG	Negative edge

Example **OUTP1:TRIG:SLOP?**
NEG
The Trig out signal is set to negative edge.

OUTPut[1]:TRIGger Source Specific Command

Description Turns the trigger out signal on or off from the Trig out terminal on the rear panel. When set to on, a trigger signal (TTL) is output at the start of each pulse. The default is setting is off.

Syntax **OUTPut[1]:TRIGger {OFF|ON}**

Example **OUT OUTP1:TRIG ON**
Enables the Trig out signal.

Query Syntax **OUTPut[1]:TRIGger?**

Return Parameter	0	Disabled
	1	Enable

Example	OUTP1:TRIG? 1	
	The Trig out signal is enabled.	
SOURce[1]:MARKer:FREQuency		Source Specific Command
Description	Sets or queries the marker frequency. The default marker frequency is 500 Hz. The marker frequency is used to output a SYNC signal from the SYNC terminal on the front panel. The SYNC signal goes logically high at the start of each sweep and goes low at the marker frequency.	
Note	The marker frequency must be between the start and stop frequencies. If the marker frequency is set to a value that is out of the range, the marker frequency will be set to the center frequency and a “settings conflict” error will be generated.	
Syntax	SOURce[1]:MARKer:FREQuency {<frequency> MINimum MAXimum}	
Parameter	<frequency>	100 µHz ~ 80 MHz(3081)/ 50MHz(3051)100 µHz ~ 1 MHz (Ramp)
Example	SOUR1:MARK:FREQ +1.0000E+03	Sets the marker frequency to 1 kHz.
Query Syntax	SOURce[1]:MARKer:FREQuency? [MINimum MAXimum]	
Return Parameter	<NR3>	Returns the marker frequency in Hz.
Example	SOUR1:MARK:FREQ? MAX +1.0000E+03	Returns the marker frequency (1 kHz).

SOURce[1]:MARKer		Source Specific Command
Description	Turns the marker frequency on or off. The default is off.	
Note	MARKer ON	The SYNC signal goes logically high at the start of each sweep and goes low at the marker frequency.
	MARKer OFF	The SYNC terminal outputs a square wave with a 50% duty cycle at the start of each sweep.
Syntax	SOURce[1]:MARKer {OFF ON}	
Example	SOUR1:MARK ON	
	Enables the marker frequency.	
Query Syntax	SOURce[1]:MARKer?	
Return Parameter	0	Disabled
	1	Enabled
Example	SOUR1:MARK?	
	1	The marker frequency is enabled.

Burst Mode Commands

Burst Mode Overview

Burst mode can be configured to use an internal trigger (N Cycle mode) or an external trigger (Gate mode) using the Trigger INPUT terminal on the rear panel. Using N Cycle mode, each time the function generator receives a trigger, the function generator will output a specified number of waveform cycles (burst). After the burst, the function generator will wait for the next trigger before outputting another burst. N Cycle is the default Burst mode.

The alternative to using a specified number of cycles, Gate mode uses the external trigger to turn on or off the output. When the Trigger INPUT signal is high*, waveforms are continuously output (creating a burst). When the Trigger INPUT signal goes low*, the waveforms will stop being output after the last waveform completes its period. The voltage level of the output will remain equal to the starting phase of the burst waveforms, ready for the signal to go high* again.

*assuming the Trigger polarity is not inverted.

Only one burst mode can be used at any one time. The burst mode depends on the source of the trigger (internal, external, manual) and the source of the burst.

Burst Mode & Source	N Cycle*	Function	
		Cycle	Phase
Triggered – IMMEDIATE, BUS	Available	Available	Available
Triggered - EXTERNAL, MANUAL	Available	Unused	Available
Gated pulse - IMMEDIATE	Unused	Unused	Available

*burst count

The following is an overview of the steps required to generate a burst waveform.

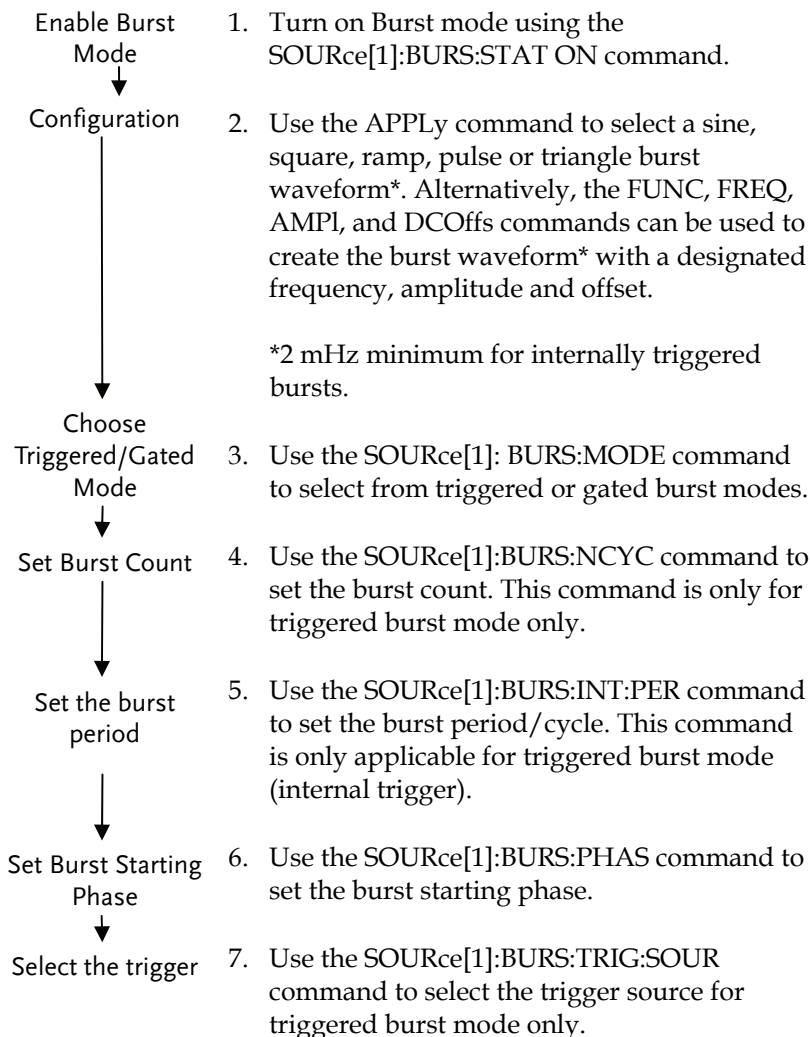

*2 mHz minimum for internally triggered bursts.

SOURce[1]:BURSt:STATe		Source Specific Command
<hr/>		
Description	Turns burst mode on or off. By default burst mode is turned off.	
Note	When burst mode is turned on, sweep and any modulation modes are disabled.	
Syntax	SOURce[1]:BURSt:STATe {OFF ON}	
Example	SOUR1:BURSt:STAT OFF Turns burst mode on.	
Query Syntax	SOURce[1]:BURSt:STATe?	
Return Parameter	0	Disabled
	1	Enabled
Example	SOUR1:BURSt:STAT? OFF Burst mode is off.	

SOURce[1]:BURSt:MODE		Source Specific Command
<hr/>		
Description	Sets or queries the burst mode as gated or triggered. The default burst mode is triggered.	
Note	The burst count, period, trigger source and any manual trigger commands are ignored in gated burst mode.	
Syntax	SOURce[1]:BURSt:MODE {TRIGgered GATed}	
Example	SOUR1:BURSt:MODE TRIG Sets the burst mode to triggered.	
Query Syntax	SOURce[1]:BURSt:MODE?	
Return Parameter	TRIG	Triggered mode
	GAT	Gated mode

Example	<p>SOUR1:BURS:MODE?</p> <p>TRIG</p> <p>The current burst mode is triggered.</p>									
	<p style="text-align: right;">Source Specific Command</p>									
SOURce[1]:BURSt:NCYCles										
Description	<p>Sets or queries the number of cycles (burst count) in triggered burst mode. The default number of cycles is 1. The burst count is ignored in gated mode.</p>									
Note	<p>If the trigger source is set to immediate, the product of the burst period and waveform frequency must be greater than the burst count:</p> <p style="padding-left: 20px;">Burst Period X Waveform frequency > burst count</p> <p>If the burst count is too large, the burst period will automatically be increased and a “Settings conflict” error will be generated.</p> <p>Only sine and square waves are allowed infinite burst above 25 MHz.</p>									
Syntax	<p>SOURce[1]:BURSt:NCYCles{< # cycles> INFIInity MINIMUM MAXimum}</p>									
Parameter	<table border="1" style="width: 100%; border-collapse: collapse;"> <tr> <td style="width: 30%;"><# cycles></td> <td>1~1,000,000 cycles.</td> </tr> <tr> <td>INFIInity</td> <td>Sets the number to continuous.</td> </tr> <tr> <td>MINIMUM</td> <td>Sets the number to minimum allowed.</td> </tr> <tr> <td>MAXimum</td> <td>Sets the number to maximum allowed.</td> </tr> </table>		<# cycles>	1~1,000,000 cycles.	INFIInity	Sets the number to continuous.	MINIMUM	Sets the number to minimum allowed.	MAXimum	Sets the number to maximum allowed.
<# cycles>	1~1,000,000 cycles.									
INFIInity	Sets the number to continuous.									
MINIMUM	Sets the number to minimum allowed.									
MAXimum	Sets the number to maximum allowed.									
Example	<p>SOUR1:BURS:NCYCl INF</p> <p>Sets the number of burst cycles to continuous (infinite).</p>									
Query Syntax	<p>SOURce[1]:BURSt:NCYCles? [MINIMUM MAXimum]</p>									
Return Parameter	<table border="1" style="width: 100%; border-collapse: collapse;"> <tr> <td style="width: 30%;"><NR3></td> <td>Returns the number of cycles.</td> </tr> <tr> <td>INF</td> <td>INF is returned if the number of cycles is continuous.</td> </tr> </table>		<NR3>	Returns the number of cycles.	INF	INF is returned if the number of cycles is continuous.				
<NR3>	Returns the number of cycles.									
INF	INF is returned if the number of cycles is continuous.									

Example	SOUR1:BURS:NCYC? +1.0000E+02	
	The burst cycles are set to 100.	
SOURce[1]:BURSt:INTerNal:PERiod	Source Specific Command	
Description	Sets or queries the burst period. Burst period settings are only applicable when the trigger is set to immediate. The default burst period is 10 ms. During manual triggering, external triggering or Gate burst mode, the burst period settings are ignored.	
Note	The burst period must be long enough to output the designated number of cycles for a selected frequency. Burst period > burst count / (waveform frequency + 200 ns) If the period is too short, it is automatically increased so that a burst can be continuously output. A "data out of range" error will also be generated.	
Syntax	SOURce[1]:BURSt:INTerNal:PERiod {<seconds> MINimum MAXimum}	
Parameter	<seconds >	1 us ~ 500 seconds
Example	SOUR1:BURS:INT:PER +1.0000E+01 Sets the period to 10 seconds.	
Query Syntax	SOURce[1]:BURSt:INTerNal:PERiod? [MINimum MAXimum]	
Return Parameter	<NR3>	Returns the burst period in seconds.
Example	SOUR1:BURS:INT:PER? +1.0000E+01 The burst period is 10 seconds.	

SOURce[1]:BURSt:PHASe Source Specific Command

Description	<p>Sets or queries the starting phase for the burst. The default phase is 0 degrees. At 0 degrees, sine square and ramp waveforms are at 0 volts.</p> <p>In gated burst mode, waveforms are continuously output (burst) when the Trig signal is true. The voltage level at the starting phase is used to determine the voltage level of the signal in-between bursts.</p>
Note	<p>The phase command is not used with pulse waveforms.</p>
Syntax	<p>SOURce[1]:BURSt:PHASe {<angle> MINimum MAXimum}</p>
Parameter	<p><angle> -360 ~ 360 degrees</p>
Example	<p>SOUR1:BURSt:PHAS MAX</p> <p>Sets the phase to 360 degrees.</p>
Query Syntax	<p>SOURce[1]:BURSt:PHASe? [MINimum MAXimum]</p>
Return Parameter	<p><NR3> Returns the phase angle in degrees.</p>
Example	<p>SOUR1:BURSt:PHAS? +1.2000E+01</p> <p>The burst phase is 120 degrees.</p>

SOURce[1]:BURSt:TRIGger:SOURce Source Specific Command

Description	<p>Sets or queries the trigger source for triggered burst mode. In triggered burst mode, a waveform burst is output each time a trigger signal is received and the number of cycles is determined by the burst count.</p> <p>There are three trigger sources for triggered burst mode:</p>
-------------	--

	Immediate	A burst is output at a set frequency determined by the burst period.
	External	EXTERNAL will output a burst waveform after each external trigger pulse. Any additional trigger pulse signals before the end of the burst are ignored.
	Manual	Manual triggering will output a burst waveform after the trigger softkey is pressed.
Note	<p>If the APPLy command was used, the source is automatically set to IMMEDIATE.</p> <p>The *OPC/*OPC? command/query can be used to signal the end of the burst.</p>	
Syntax	SOURCE[1]:BURSt:TRIGger:SOURCE {IMMEDIATE EXTERNAL MANUAL}	
Example	<p>SOUR1:BURS:TRIG:SOuR EXT</p> <p>Sets the burst trigger source to external.</p>	
Query Syntax	SOURCE[1]:BURSt:TRIGger:SOURCE?	
Return Parameter	IMM	Immediate
	EXT	External
	MANUAL	Manual
Example	<p>SOUR1:BURS:TRIG:SOuR?</p> <p>IMM</p> <p>The burst trigger source is set to immediate.</p>	
	SOURCE[1]:BURSt:TRIGger:DELay	Source Specific Command
Description	<p>The DELay command is used to insert a delay (in seconds) before a burst is output. The delay starts after a trigger is received. The default delay is 0 seconds.</p>	

Syntax	SOURce[1]: BURSt:TRIGger:DELay {<seconds> MINimum MAXimum}	
Parameter	<seconds>	0~85 seconds
Example	SOUR1:BURS:TRIG:DEL +1.0000E+01 Sets the trigger delay to 10 seconds.	
Query Syntax	SOURce[1]:BURSt:TRIGger:DELay? [MINimum MAXimum]	
Return Parameter	<NRf>	Delay in seconds
Example	SOUR1:BURS:TRIG:DEL +1.0000E+01 The trigger delay is 10 seconds.	

SOURce[1]:BURSt:TRIGger:SLOPe Source Specific Command

Description	Sets or queries the trigger edge for externally triggered bursts from the Trigger INPUT terminal on the rear panel. By default the trigger is rising edge (Positive).	
Syntax	SOURce[1]:BURSt:TRIGger:SLOPe {POSitive NEGative}	
Parameter	POSitive NEGative	rising edge falling edge
Example	SOUR1:BURS:TRIG:SLOP NEG Sets the trigger slope to negative.	
Query Syntax	SOURce[1]:BURSt:TRIGger:SLOPe?	
Return Parameter	POS NEG	rising edge falling edge
Example	SOUR1:BURS:TRIG:SLOP NEG The trigger slope is negative.	

SOURce[1]:BURSt:GATE:POLarity		Source Specific Command
Description	In gated mode, the function generator will output a waveform continuously while the external trigger receives logically true signal from the Trigger INPUT terminal. Normally a signal is logically true when it is high. The logical level can be inverted so that a low signal is considered true.	
Syntax	SOURce[1]:BURSt:GATE:POLarity{NORMal INVertes}	
Parameter	NORMal	Logically high
	INVertes	Logically low
Example	SOUR1:BURS:GATE:POL INV Sets the state to logically low (inverted).	
Query Syntax	SOURce[1]:BURSt:GATE:POLarity?	
Return Parameter	NORM	Normal(High) logical level
	INV	Inverted (low) logical level
Example	SOUR1:BURS:GATE:POL? INV The true state is inverted(logically low).	

SOURce[1]:BURSt:OUTPut:TRIGger:SLOPe Source Specific Command

Description Sets or queries the trigger edge of the trigger output signal. The signal is output from the trigger out terminal on the rear panel. The default trigger output slope is positive.

Note The trigger output signal on the rear panel depends on the burst trigger source or mode:

Immediate	50% duty cycle square wave is output at the start of each burst.
External	Trigger output disabled.
Gated mode	Trigger output disabled.
Manual	A >1 ms pulse is output at the start of each burst.

Syntax **SOURce[1]:BURSt:OUTPut:TRIGger:SLOPe {POSitive|NEGative}**

Parameter	POSitive	Rising edge.
	NEGative	Falling edge.

Example **SOUR1:BURS:OUTP:TRIG:SLOP POS**

Sets the trigger output signal slope to positive (rising edge).

Query Syntax **SOURce[1]:BURSt:OUTPut:TRIGger:SLOPe?**

Return Parameter	POS	Rising edge.
	NEG	Falling edge.

Example **SOUR1:BURS:OUTP:TRIG:SLOP?**

POS

The trigger output signal slope to positive.

OUTPut:TRIGger		Source Specific Command
Description	Sets or queries the trigger output signal on or off. By default the signal is disabled. When enabled, a TTL compatible square wave is output. This function applies to sweep as well as burst mode.	
Syntax	OUTPut[1]:TRIGger {OFF ON}	
Parameter	OFF	Turns the output off.
	ON	Turns the output on.
Example	OUTP1:TRIG ON Turns the output on.	
Query Syntax	OUTPut[1]:TRIGger?	
Return Parameter	0	Disabled
	1	Enabled
Query Example	OUTP1:TRIG? 1 The trigger output is enabled.	

Arbitrary Waveform Commands

Arbitrary Waveform Overview

Use the steps below to output an arbitrary waveform over the remote interface.

- | | |
|---|--|
| Output Arbitrary Waveform | 1. Use the SOURce[1]:FUNCtion USER command to output the arbitrary waveform currently selected in memory. |
| ↓ | |
| Select Waveform Frequency, amplitude and offset | 2. Use the APPLy command to select frequency, amplitude and DC offset. Alternatively, the FUNC, FREQ, AMPL, and DCOffs commands can be used. |
| ↓ | |
| Load Waveform Data | 3. Waveform data (1 to 1,048,576 points per waveform) can be downloaded into volatile memory using the DATA:DAC command. Binary integer or decimal integer values in the range of ± 32767 can be used. |
| ↓ | |
| Set Waveform Rate | 4. The waveform rate is the product of the number of points in the waveform and the waveform frequency. |

$$\text{Rate} = \text{Hz} \times \# \text{ points}$$

Range:	Rate: 10 μ Hz ~ 200MHz
	Frequency: 10 μ Hz ~ 100MHz
	# points: 1~1,048,576

SOURce[1]:FUNction USER Source Specific Command

Description Use the SOURce[1]:FUNction USER command to output the arbitrary waveform currently selected in memory. The waveform is output with the current frequency, amplitude and offset settings.

Syntax **SOURce[1]:FUNction USER**

Example **SOUR1:FUNC USER**
 Selects and outputs the current waveform in memory.

DATA:DAC Source Specific Command

Description The DATA:DAC command is used to download binary or decimal integer values into memory using the IEEE-488.2 binary block format or as an ordered list of values.

Note The integer values (± 32767) correspond to the maximum and minimum peak amplitudes of the waveform. For instance, for a waveform with an amplitude of 5Vpp (0 offset), the value 32767 is the equivalent of 2.5 Volts. If the integer values do not span the full output range, the peak amplitude will be limited.

The IEEE-488.2 binary block format is comprised of three parts:

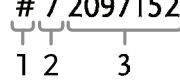
- | | |
|---|--|
| $\# \ 7 \ 2097152$
 | <ol style="list-style-type: none"> 1. Initialization character (#) 2. Digit length (in ASCII) of the number of bytes 3. Number of bytes |
|---|--|

IEEE 488.2 uses two bytes to represent waveform data (16 bit integer). Therefore the number of bytes is always twice the number of data points.

Syntax	DATA:DAC VOLATILE, <start>, {<binary block> <value>, <value>, ... }	
Parameter	<start>	Start address of the arbitrary waveform
	<binary block>	
	<value>	Decimal or integer values ±32767
Example	<p>DATA:DAC VOLATILE, #216 Binary Data</p> <p>The command above downloads 5 data values (stored in 16 bytes) using the binary block format.</p> <p>DATA:DAC VOLATILE, 1000, 32767, 2048, 0, -2048, -32767</p> <p>Downloads the data values (32767, 2048, 0, -2048, -32767) to address 1000.</p>	

SOURce[1]:ARB:EDIT:COPY Source Specific Command

Description	Copies a segment of a waveform to a specific starting address.	
Syntax	SOURce[1]:ARB:EDIT:COPY [<start>[, <length>[, <paste>]]]	
Parameter	<start>	Start address: 0~1048,576
	<length>	0 ~ 1048,576
	<paste>	Paste address: 0~1048,576
Example	<p>SOUR1:ARB:EDIT:COPY 1000, 256, 1257</p> <p>Copies 256 data values starting at address 1000 and copies them to address 1257.</p>	

SOURce[1]:ARB:EDIT:DELeTE Source Specific Command

Description	Deletes a segment of a waveform from memory. The segment is defined by a starting address and length.	
-------------	---	--

Note	A waveform/waveform segment cannot be deleted when output.	
Syntax	SOURce[1]:ARB:EDIT:DELeTe [<START>[,<LENGTh>]]	
Parameter	<START>	Start address: 0~1048,576
	<LENGTh>	0 ~ 1048,576
Example	SOURce1:ARB:EDIT:DEL 1000, 256 Deletes a section of 256 data points from the waveform starting at address 1000.	

SOURce[1]:ARB:EDIT:DELeTe:ALL Source Specific Command

Description	Deletes all user-defined waveforms from non-volatile memory and the current waveform in volatile memory.	
Note	A waveform cannot be deleted when output.	
Syntax	SOURce[1]:ARB:EDIT:DELeTe:ALL	
Example	SOUR1:ARB:EDIT:DEL:ALL Deletes all user waveforms from memory.	

SOURce[1]:ARB:EDIT:POINt Source Specific Command

Description	Edit a point on the arbitrary waveform.	
Note	A waveform/waveform segment cannot be deleted when output.	
Syntax	SOURce[1]:ARB:EDIT:POINt [<address> [, <data>]]	
Parameter	<address>	Address of data point: 0~1,048,576
	<data>	Value data: ± 32,767
Example	SOUR1:ARB:EDIT:POIN 1000, 32767 Creates a point on the arbitrary waveform at address 1000 with the highest amplitude.	

SOURce[1]:ARB:EDIT:LINE		Source Specific Command
Description	Edit a line on the arbitrary waveform. The line is created with a starting address and data point and a finishing address and data point.	
Note	A waveform/ waveform segment cannot be deleted when output.	
Syntax	SOURce[1]:ARB:EDIT:LINE [<address1>[,<data>[,<address2>[,<data2>]]]]	
Parameter	<address1>	Address of data point1: 0~1,048,576
	<data1>	Value data2: ± 32,767
	<address2>	Address of data point2: 0~1,048,576
	<data2>	Value data2: ± 32,767
Example	SOUR1:ARB:EDIT:LINE 40, 50, 100, 50 Creates a line on the arbitrary waveform at 40,50 to 100,50.	

SOURce[1]:ARB:EDIT:PROTect		Source Specific Command
Description	Protects a segment of the arbitrary waveform from deletion or editing.	
Syntax	SOURce[1]:ARB:EDIT:PROTect [<START>[,<LENGTh>]]	
Parameter	<START>	Start address: 0~1048,576
	<LENGTh>	0 ~ 1048,576
Example	SOUR1:ARB:EDIT:PROT 40, 50 Protects a segment of the waveform from address 40 for 50 data points.	

SOURce[1]:ARB:EDIT:PROTect:ALL		Source Specific Command
		Command

Description Protects the arbitrary waveform currently in non-volatile memory/ currently being output.

Syntax **SOURce[1]:ARB:EDIT:PROTECT:ALL**

Example **SOUR1:ARB:EDIT:PROT:ALL**

SOURce[1]:ARB:EDIT:UNProtect Source Specific Command

Description Uprotects the arbitrary waveform currently in non-volatile memory/ currently being output.

Syntax **SOURce[1]:ARB:EDIT:UNProtect**

Example **SOUR1:ARB:EDIT:UNP**

SOURce[1]:ARB:BUILt:SINusoid Source Specific Command

Description Creates a sinusoid with a specified start address, length and scale.

Syntax **SOURce[1]:ARB:BUILt:SINusoid**
[<START>[,<LENGth>[,<SCALE>]]]

Parameter	<START>	Start address*: 0~1048,576
	<LENGth>	Length*: 0 ~ 1048,576
	<SCALE>	Scale: ±32767

* Start + Length ≤ 1,048,576

Example **SOUR1:ARB:BUIL:SIN 1000, 1000, 100**
 Creates a sin wave 1000 points in length with a scale of 100 and a start address of 1000.

SOURce[1]:ARB:BUILt:SQUare Source Specific Command

Description Creates a square wave with a specified start address, length and scale.

Syntax **SOURce[1]:ARB:BUILt:SQUare**
[<START>[,<LENGth>[,<SCALE>]]]

Parameter	<START>	Start address*: 0~1048,576
	<LENGth>	Length*: 0 ~ 1048,576
	<SCALe>	Scale: ±32767
* Start + Length ≤ 1,048,576		

Example **SOUR1:ARB:BUIL:SQU 1000, 1000, 100**
 Creates a square wave 1000 points in length with a scale of 100 and a start address of 1000.

SOURce[1]:ARB:BUILt:PULSe Source Specific Command

Description Creates a pulse wave with a specified frequency and duty.

Syntax **SOURce[1]:ARB:BUILt:PULSe**
[<FREQUency>[,<DUTY>]]

Parameter	<FREQUency>	1pHz~500kHz*	
	<DUTY>	0.0001%~99.9999%	
	*Frequency	Resolution	Duty Resolution
	1pHz~5Hz	1pHz	0.0001%
	>5Hz~50Hz	1uHz	0.0001%
	>50Hz~500Hz	10uHz	0.001%
	>500Hz~5kHz	100uHz	0.01%
	>5kHz~50kHz	1mHz	0.1%
	>50kHz~500kHz	10mHz	1%

Example **SOUR1:ARB:BUIL:PULSe +1.00000002E+03,**
+1.002E+01
 Creates a 1000.0002Hz pulse wave with a 10.02% duty cycle.

SOURce[1]:ARB:BUILt:RAMP Source Specific Command

Description	Creates a ramp wave with a specified start address, length and scale.	
Syntax	SOURce[1]:ARB:BUILt:RAMP[<START>,<LENGth>,<SCALe>]]]	
Parameter	<START>	Start address*: 0~1048,576
	<LENGth>	Length*: 0 ~ 1048,576
	<SCALe>	Scale: ±32767
	* Start + Length ≤ 1,048,576	
Example	SOUR1:ARB:BUIL:RAMP 1000, 1000, 100 Creates a ramp wave 1000 points in length with a scale of 100 and a start address of 1000.	

SOURce[1]:ARB:BUILt:SINC Source Specific Command

Description	Creates a sinc wave with a specified start address, length and scale.	
Syntax	SOURce[1]:ARB:BUILt:SINC [<START>,<LENGth>,<SCALe>]]]	
Parameter	<START>	Start address*: 0~1048,576
	<LENGth>	Length*: 0 ~ 1048,576
	<SCALe>	Scale: ±32767
	* Start + Length ≤ 1,048,576	
Example	SOUR1:ARB:BUIL:SINC 1000, 1000, 100 Creates a sinc wave 1000 points in length with a scale of 100 and a start address of 1000.	

SOURce[1]:ARB:BUILt:EXPRise		Source Specific Command
Description	Creates an exponential rise wave with a specified start address, length and scale.	
Syntax	SOURce[1]:ARB:BUILt:EXPRise [<START>[,<LENGth>[,<SCALE>]]]	
Parameter	<START>	Start address*: 0~1048,576
	<LENGth>	Length*: 0 ~ 1048,576
	<SCALE>	Scale: ±32767
	* Start + Length ≤ 1,048,576	
Example	SOUR1:ARB:BUIL:EXPR 1000, 1000, 100 Creates a exponential rise wave 1000 points in length with a scale of 100 and a start address of 1000.	

SOURce[1]:ARB:BUILt:EXPFail		Source Specific Command
Description	Creates a DC waveform with a specified start address, length and scale.	
Syntax	SOURce[1]:ARB:BUILt:EXPFail [<START>[,<LENGth>[,<SCALE>]]]	
Parameter	<START>	Start address*: 0~1048,576
	<LENGth>	Length*: 0 ~ 1048,576
	<SCALE>	Scale: ±32767
	* Start + Length ≤ 1,048,576	
Example	SOUR1:ARB:BUIL:EXPF 1000, 1000, 100 Creates an exponential fall wave 1000 points in length with a scale of 100 and a start address of 1000.	

SOURce[1]:ARB:BUILt:DC Source Specific Command

Description	Creates an exponential fall wave with a specified start address, length and scale.	
Syntax	SOURce[1]:ARB:BUILt:DC [<START>[,<LENGth>[,<SCALe>]]]	
Parameter	<START>	Start address*: 0~1048,576
	<LENGth>	Length*: 0 ~ 1048,576
	<SCALe>	Scale: ±32767
	* Start + Length ≤ 1,048,576	
Example	SOUR1:ARB:BUIL:DC 1000, 1000, 100 Creates an exponential fall wave 1000 points in length with a scale of 100 and a start address of 1000.	

SOURce[1]:ARB:NCYCles Source Specific Command

Description	The arbitrary waveform output can be repeated for a designated number of cycles.	
Syntax	SOURce[1]:ARB:NCYCles {< #cycles> INFinity MINimum MAXimum}	
Parameter	<# cycles>	1~1,048,575 cycles
	INFinity	Sets the number of cycles to continuous.
	MINimum	Sets the number of cycles to the minimum allowed.
	MAXimum	Sets the number of cycles to the maximum allowed.
Example	SOUR1:ARB:NCYCI INF Sets the number of ARB waveform output cycles to continuous (infinite).	
Query Syntax	SOURce[1]:ARB:NCYCles? [MINimum MAXimum]	

Return Parameter	<NR3>	Returns the number of cycles.
	INF	INF is returned if the number of cycles is continuous.

Example **SOUR1:ARB:NCYC?**
+1.0000E+02
 The number of ARB waveform output cycles is returned (100).

SOURce[1]:ARB:OUTPut:MARKer Source Specific Command

Description Define a section of the arbitrary waveform for marker output. The marker is output from the SYNC terminal on the front panel.

Syntax **SOURce[1]:ARB:OUTPut:MARKer**
[<START>[,<LENGth>]]

Parameter	<START>	Start address*: 0~1048,576
	<LENGth>	Length*: 0 ~ 1048,576
* Start + Length ≤ currently output arbitrary waveform		

Example **SOUR1:ARB:OUTP:MARK 1000, 1000**
 The marker output is for a start address of 1000 with a length of 1000.

SOURce[1]:ARB:OUTPut Source Specific Command

Description Output the current arbitrary waveform in volatile memory. A specified start and length can also be designated.

Syntax **SOURce[1]:ARB:OUTPut [<START>[,<LENGth>]]**

Parameter	<START>	Start address*: 0~1048,576
	<LENGth>	Length*: 0 ~ 1048,576
* Start + Length ≤ currently output arbitrary waveform		

Example **SOUR1:ARB:OUTP 20 200**

Outputs the current arbitrary waveform in memory.

Save and Recall Commands

Up to 10 different instrument states can be stored to non-volatile memory (memory locations 0~9).

		Instrument Command
*SAV		
Description	Saves the current instrument state to a specified save slot. When a state is saved, all the current instrument settings, functions and waveforms are also saved.	
Note	The *SAV command doesn't save waveforms in non-volatile memory, only the instrument state. The *RST command will not delete saved instrument states from memory.	
Syntax	*SAV {0 1 2 3 4 5 6 7 8 9}	
Example	*SAV 0 Save the instrument state to memory location 0.	
*RCL		Instrument Command
Description	Recall previously saved instrument states from memory locations 0~9.	
Syntax	*RCL {0 1 2 3 4 5 6 7 8 9}	
Example	*RCL 0 Recall instrument state from memory location 0.	
MEMory:STATe:DElete		Instrument Command
Description	Delete memory from a specified memory location.	

Syntax **MEMory:STATe:DELeTe {0|1|2|3|4|5|6|7|8|9}**

Example **MEM:STAT:DEL 0**
 Delete instrument state from memory location 0.

MEMory:STATe:DELeTe ALL Instrument Command

Description Delete memory from all memory locations, 0~9.

Syntax **MEMory:STATe:DELeTe ALL**

Example **MEM:STAT:DEL ALL**
 Deletes all the instrument states from memory locations 0~9.

Error Messages

The AFG-3000 has a number of specific error codes. Use the SYSTem:ERRor command to recall the error codes. For more information regarding the error queue, see page 294.

Command Error Codes

-101 Invalid character

An invalid character was used in the command string. Example: #, \$, %.

```
SOURce1:AM:DEPTH MIN%
```

-102 Syntax error

Invalid syntax was used in the command string. Example: An unexpected character may have been encountered, like an unexpected space.

```
SOURce1:APPL:SQUare , 1
```

-103 Invalid separator

An invalid separator was used in the command string. Example: a space, comma or colon was incorrectly used.

```
APPL:SIN 1 1000 OR SOURce1:APPL:SQUare
```

-108 Parameter not allowed

The command received more parameters than were expected. Example: An extra (not needed) parameter was added to a command

```
SOURce1:APPL? 10
```

-109 Missing parameter

The command received less parameters than expected. Example: A required parameter was omitted.

```
SOURce1:APPL:SQUare
```

-112 Program mnemonic too long

A command header contains more than 12 characters:

OUTP:SYNCHRONIZATION ON

-113 Undefined header

An undefined header was encountered. The header is syntactically correct. Example: the header contains a character mistake.

SOUR1:AMM:DEPT MIN

-123 Exponent too large

Numeric exponent exceeds 32,000. Example:

SOURce[1]:BURSt:NCYCles 1E34000

-124 Too many digits

The mantissa (excluding leading 0's) contains more than 255 digits.

-128 Numeric data not allowed

An unexpected numeric character was received in the command. Example: a numeric parameter is used instead of a character string.

SOURce1:BURSt:MODE 123

-131 Invalid suffix

An invalid suffix was used. Example: An unknown or incorrect suffix may have been used with a parameter.

SOURce1:SWEep:TIME 0.5 SECS

-138 Suffix not allowed

A suffix was used where none were expected. Example: Using a suffix when not allowed.

SOURce1:BURSt: NCYCles 12 CYC

-148 Character data not allowed

A parameter was used in the command where not allowed. Example: A discrete parameter was used where a numeric parameter was expected.

SOUR1:MARK:FREQ ON

-158 String data not allowed

An unexpected character string was used where none were expected. Example: A character string is used instead of a valid parameter.

SOURce1:SWEep:SPACing 'TEN'

-161 Invalid block data

Invalid block data was received. Example: The number of bytes sent with the DATA:DAC command doesn't correlate to the number of bytes specified in the block header.

-168 Block data not allowed

Block data was received where block data is not allowed. Example:

SOURce1:BURSt: NCYCles #10

-170~178 expression errors

Example: The mathematical expression used was not valid.

Execution Errors

-211 Trigger ignored

A trigger was received but ignored. Example: Triggers will be ignored until the function that can use a trigger is enabled (burst, sweep, etc.).

-223 Too much data

Data was received that contained too much data. Example: An arbitrary waveform with over 1,048,576 points cannot be used.

-221 Settings conflict; turned off infinite burst to allow immediate trigger source

Example: Infinite burst is disabled when an immediate trigger source is selected. Burst count set to 1,000,000 cycles.

-221 Settings conflict; infinite burst changed trigger source to MANUAL

Example: The trigger source is changed to immediate from manual when infinite burst mode is selected.

-221 Settings conflict; burst period increased to fit entire burst

Example: The function generator automatically increases the burst period to allow for the burst count or frequency.

-221 Settings conflict; burst count reduced

Example: The burst count is reduced to allow for the waveform frequency if the burst period is at its maximum.

-221 Settings conflict; trigger delay reduced to fit entire burst

Example: The trigger delay is reduced to allow the current period and burst count.

-221 Settings conflict; triggered burst not available for noise

Example: Triggered burst cannot be used with noise.

-221 Settings conflict; amplitude units changed to Vpp due to high-Z load

Example: If a high impedance load is used, dBm units cannot be used. The units are automatically set to Vpp.

-221 Settings conflict; trigger output disabled by trigger external

Example: The trigger output terminal is disabled when an external trigger source is selected.

-221 Settings conflict; trigger output connector used by FSK

Example: The trigger output terminal cannot be used in FSK mode.

-221 Settings conflict; trigger output connector used by burst gate

Example: The trigger output terminal cannot be used in gated burst mode.

-221 Settings conflict;trigger output connector used by trigger external

Example: The trigger output connector is disabled when the trigger source is set to external.

-221 Settings conflict;frequency reduced for pulse function

Example: When the function is changed to pulse, the output frequency is automatically reduced if over range.

-221 Settings conflict;frequency reduced for ramp function

Example: When the function is changed to ramp, the output frequency is automatically reduced if over range.

-221 Settings conflict;frequency made compatible with burst mode

Example: When the function is changed to burst, the output frequency is automatically adjusted if over range.

-221 Settings conflict;frequency made compatible with FM

Example: When the function is changed to FM, the frequency is automatically adjusted to suit the FM settings.

-221 Settings conflict;burst turned off by selection of other mode or modulation

Example: Burst mode is disabled when sweep or a modulation mode is enabled.

-221 Settings conflict;FSK turned off by selection of other mode or modulation

Example: FSK mode is disabled when burst, sweep or a modulation mode is enabled.

-221 Settings conflict;FM turned off by selection of other mode or modulation

Example: FM mode is disabled when burst, sweep or a modulation mode is enabled.

-221 Settings conflict;AM turned off by selection of other mode or modulation

Example: AM mode is disabled when burst, sweep or a modulation mode is enabled.

-221 Settings conflict; sweep turned off by selection of other mode or modulation

Example: Sweep mode is disabled when burst or a modulation mode is enabled.

-221 Settings conflict;not able to modulate this function

Example: A modulated waveform cannot be generated with dc voltage, noise or pulse waveforms.

-221 Settings conflict;not able to sweep this function

Example: A swept waveform cannot be generated with dc voltage, noise or pulse waveforms.

-221 Settings conflict;not able to burst this function

Example: A burst waveform cannot be generated with the dc voltage function.

-221 Settings conflict;not able to modulate noise, modulation turned off

Example: A waveform cannot be modulated using the noise function.

-221 Settings conflict;not able to sweep pulse, sweep turned off

Example: A waveform cannot be swept using the pulse function.

-221 Settings conflict;not able to modulate dc, modulation turned off

Example: A waveform cannot be modulated using the dc voltage function.

-221 Settings conflict;not able to sweep dc, modulation turned off

Example: A waveform cannot be swept using the dc voltage function.

-221 Settings conflict;not able to burst dc, burst turned off

Example: The burst function cannot be used with the dc voltage function.

-221 Settings conflict;not able to sweep noise, sweep turned off

Example: A waveform cannot be swept using the noise function.

-221 Settings conflict;pulse width decreased due to period

Example: The pulse width has been adjusted to suit the period settings.

-221 Settings conflict;amplitude changed due to function

Example: The amplitude (VRM / dBm) has been adjusted to suit the selected function. For the AFG-3000, a typical square wave has a much higher amplitude (5V Vrms) compared to a sine wave (~3.54) due to crest factor.

-221 Settings conflict;offset changed on exit from dc function

Example: The offset level is adjusted on exit from a DC function.

-221 Settings conflict;FM deviation cannot exceed carrier

Example: The deviation cannot be set higher than the carrier frequency

-221 Settings conflict;FM deviation exceeds max frequency

Example: If the FM deviation and carrier frequency combined exceeds the maximum frequency plus 100 kHz, the deviation is automatically adjusted.

-221 Settings conflict;frequency forced duty cycle change

Example: If the frequency is changed and the current duty cannot be supported at the new frequency, the duty will be automatically adjusted.

-221 Settings conflict;offset changed due to amplitude

Example: The offset is not a valid offset value, it is automatically adjusted, considering the amplitude.

$$|\text{offset}| \leq \text{max amplitude} - V_{pp}/2$$

-221 Settings conflict;amplitude changed due to offset

Example: The amplitude is not a valid value, it is automatically adjusted, considering the offset.

$$V_{pp} \leq 2X (\text{max amplitude} - |\text{offset}|)$$

-221 Settings conflict;low level changed due to high level

Example: The low level value was set too high. The low level is set 1 mV less than the high level.

-221 Settings conflict;high level changed due to low level

Example: The high level value was set too low. The high level is set 1 mV greater than the low level.

-222 Data out of range;value clipped to upper limit

Example: The parameter was set out of range. The parameter is automatically set to the maximum value allowed.

SOURCE[1]:FREQUENCY 80.1MHz.

-222 Data out of range;value clipped to lower limit

Example: The parameter was set out of range. The parameter is automatically set to the minimum value allowed.

SOURCE[1]:FREQUENCY 0.1μHz.

-222 Data out of range;period; value clipped to ...

Example: If the period was set to a value out of range, it is automatically set to an upper or lower limit.

-222 Data out of range;frequency; value clipped to ...

Example: If the frequency was set to a value out of range, it is automatically set to an upper or lower limit.

-222 Data out of range;user frequency; value clipped to upper limit

Example: If the frequency is set to a value out of range for an arbitrary waveform using, SOURce[1]: APPL: USER or SOURce[1]: FUNC:USER, it is automatically set to the upper limit.

-222 Data out of range;ramp frequency; value clipped to upper limit

Example: If the frequency is set to a value out of range for a ramp waveform using, SOURce[1]: APPL: RAMP or SOURce[1]: FUNC:RAMP, it is automatically set to the upper limit.

-222 Data out of range;pulse frequency; value clipped to upper limit

Example: If the frequency is set to a value out of range for a pulse waveform using, SOURce[1]: APPL:PULS or SOURce[1]: FUNC:PULS, it is automatically set to the upper limit.

-222 Data out of range;burst period; value clipped to ...

Example: If the burst period was set to a value out of range, it is automatically set to an upper or lower limit.

222 Data out of range;burst count; value clipped to ...

Example: If the burst count was set to a value out of range, it is automatically set to an upper or lower limit.

-222 Data out of range; burst period limited by length of burst; value clipped to upper limit

Example: The burst period must be greater than burst count divided by the frequency + 200 ns. The burst period is adjusted to satisfy these conditions.

$\text{burst period} > 200 \text{ ns} + (\text{burst count} / \text{burst frequency})$.

-222 Data out of range; burst count limited by length of burst; value clipped to lower limit

Example: The burst count must be less than burst period * the waveform frequency when the trigger source is set to immediate (SOURce[1]:TRIG:SOUR IMM). The burst count is automatically set to the lower limit.

-222 Data out of range; amplitude; value clipped to ...

Example: If the amplitude was set to a value out of range, it is automatically set to an upper or lower limit.

-222 Data out of range; offset; value clipped to ...

Example: If the offset was set to a value out of range, it is automatically set to an upper or lower limit.

-222 Data out of range; frequency in burst mode; value clipped to ...

Example: If the frequency was set to a value out of range in burst mode. The burst frequency is automatically set to an upper or lower limit, taking the burst period into account.

-222 Data out of range; frequency in FM; value clipped to ...

Example: The carrier frequency is limited by the frequency deviation (SOURce[1]:FM:DEV). The carrier frequency is automatically adjusted to be less than or equal to the frequency deviation.

-222 Data out of range;marker confined to sweep span; value clipped to ...

Example: The marker frequency is set to a value outside the start or stop frequencies. The marker frequency is automatically adjusted to either the start or stop frequency (whichever is closer to the set value).

-222 Data out of range;FM deviation; value clipped to ...

Example: The frequency deviation is outside of range. The deviation is automatically adjusted to an upper or lower limit, depending on the frequency.

-222 Data out of range;trigger delay; value clipped to upper limit

Example: The trigger delay was set to a value out of range. The trigger delay has been adjusted to the maximum (85 seconds).

-222 Data out of range; trigger delay limited by length of burst; value clipped to upper limit

Example: The trigger delay and the burst cycle time combined must be less than the burst period.

-222 Data out of range;duty cycle; value clipped to ...

Example: The duty cycle is limited depending on the frequency.

Duty Cycle	Frequency
50%	> 50MHz
40%~60%	25 MHz ~ 50MHz
20%~80%	< 25 MHz

-222 Data out of range; duty cycle limited by frequency; value clipped to upper limit

Example: The duty cycle is limited depending on the frequency. When the frequency is greater than 50 MHz, the duty cycle is automatically limited to 50%.

-313 Calibration memory lost;memory corruption detected

Indicates that a fault (check sum error) has occurred with the non-volatile memory that stores the calibration data.

-314 Save/recall memory lost;memory corruption detected

Indicates that a fault (check sum error) has occurred with the non-volatile memory that stores the save/recall files.

-315 Configuration memory lost;memory corruption detected

Indicates that a fault (check sum error) has occurred with the non-volatile memory that stores the configuration settings.

-350 Queue overflow

Indicates that the error queue is full (over 20 messages generated, and not yet read). No more messages will be stored until the queue is empty. The queue can be cleared by reading each message, using the *CLS command or restarting the function generator.

-361 Parity error in program message

Indicates that there is a RS232 parity setting mismatch between the host PC and the function generator.

-362 Framing error in program message

Indicates that there is a RS232 stop bit setting mismatch between the host PC and the function generator.

-363 Input buffer overrun

Indicates that too many characters have been sent to the function generator via RS232. Ensure handshaking is used.

Query Errors

-410 Query INTERRUPTED

Indicates that a command was received but the data in the output buffer from a previous command was lost.

-420 Query UNTERMINATED

The function generator is ready to return data, however there was no data in the output buffer. For example: Using the APPLY command.

-430 Query DEADLOCKED

Indicates that a command generates more data than the output buffer can receive and the input buffer is full. The command will finish execution, though all the data won't be kept.

Arbitrary Waveform Errors

-770 Nonvolatile arb waveform memory corruption detected

Indicates that a fault (check sum error) has occurred with the non-volatile memory that stores the arbitrary waveform data.

-781 Not enough memory to store new arb waveform; bad sectors

Indicates that a fault (bad sectors) has occurred with the non-volatile memory that stores the arbitrary waveform data. Resulting in not enough memory to store arbitrary data.

-787 Not able to delete the currently selected active arb waveform

Example: The currently selected waveform is being output and cannot be deleted.

800 Block length must be even

Example: As block data (DATA:DAC VOLATILE) uses two bytes to store each data point, there must be an even number of bytes for a data block.

SCPI Status Registers

The status registers are used to record and determine the status of the function generator.

The function generator has a number of register groups:

Questionable Status Registers

Standard Event Status Registers

Status Byte Register

As well as the output and error queues.

Each register group is divided into three types of registers: condition registers, event registers and enable registers.

Register types

Condition Register	The condition registers indicate the state of the function generator in real time. The condition registers are not triggered. I.e., the bits in the condition register change in real time with the instrument status. Reading a condition register will not clear it. The condition registers cannot be cleared or set.
Event Register	The Event Registers indicate if an event has been triggered in the condition registers. The event registers are latched and will remain set unless the *CLS command is used. Reading an event register will not clear it.
Enable Register	The Enable register determines which status event(s) are enabled. Any status events that are not enabled are ignored. Enabled events are used to summarize the status of that register group.

AFG-3000 Status System

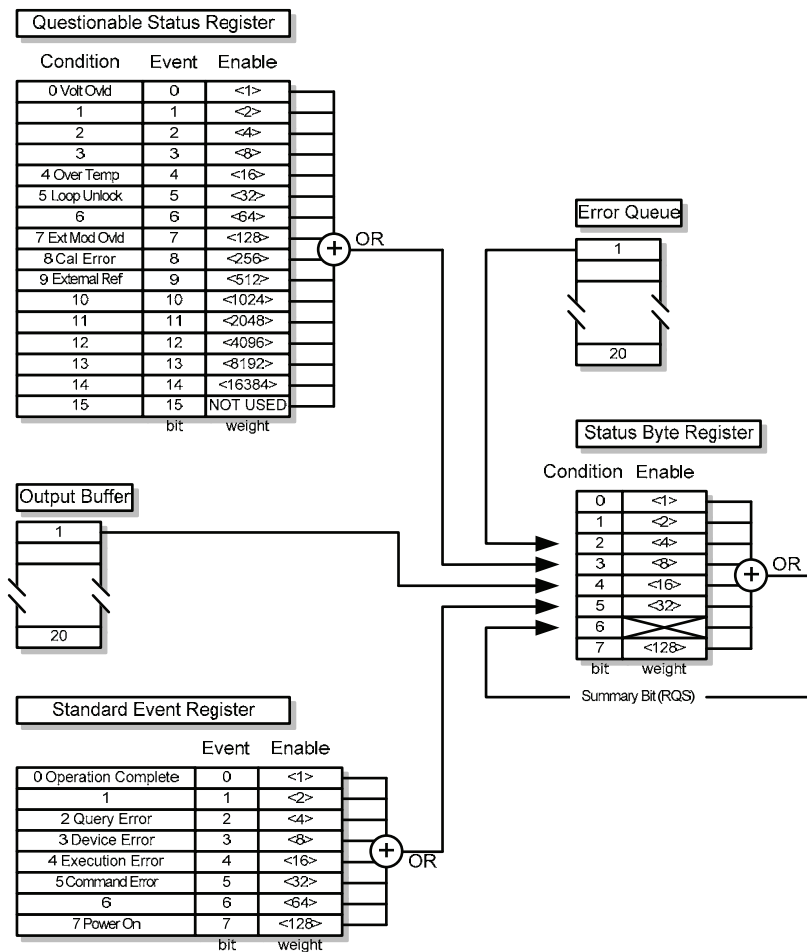

Questionable Status Register

Description	The Questionable Status Registers will show if any faults or errors have occurred.		
Bit Summary	Register	Bit	Bit Weight
	Voltage overload	0	1
	Over temperature	4	16
	Loop unlock	5	32
	Ext Mod Overload	7	128
	Cal Error	8	256
	External Reference	9	512

Standard Event Status Registers

Description	The Standard Event Status Registers indicate when the *OPC command has been executed or whether any programming errors have occurred.
Notes	<p>The Standard Event Status Enable register is cleared when the *ESE 0 command is used.</p> <p>The Standard Event Status Event register is cleared when the *CLS command or the *ESR? command is used.</p>

Bit Summary	Register	Bit	Bit Weight
	Operation complete bit	0	1
	Query Error	2	4
	Device Error	3	8
	Execution Error	4	16
	Command Error	5	32
	Power On	7	128

Error Bits	Operation complete	The operation complete bit is set when all selected pending operations are complete. This bit is set in response to the *OPC command.
	Query Error	The Query Error bit is set when there is an error reading the Output Queue. This can be caused by trying to read the Output Queue when there is no data present.
	Device Error	The Device Dependent Error indicates a failure of the self-test, calibration, memory or other device dependent error.
	Execution Error	The Execution bit indicates an execution error has occurred.
	Command Error	The Command Error bit is set when a syntax error has occurred.
	Power On	Power has been reset.

The Status Byte Register

Description	<p>The Status Byte register consolidates the status events of all the status registers. The Status Byte register can be read with the *STB? query or a serial poll and can be cleared with the *CLS command.</p> <p>Clearing the events in any of the status registers will clear the corresponding bit in the Status Byte register.</p>		
Notes	<p>The Status byte enable register is cleared when the *SRE 0 command is used.</p> <p>The Status Byte Condition register is cleared when the *CLS command is used.</p>		
Bit Summary	Register	Bit	Bit Weight
	Error Queue	2	4
	Questionable Data	3	8
	Message Available	4	16
	Standard Event	5	32
	Master Summary / Request Service	6	64
Status Bits	Error Queue	There are error message(s) waiting in the error queue.	
	Questionable data	The Questionable bit is set when an “enabled” questionable event has occurred.	
	Message Available	The Message Available bit is set when there is outstanding data in the Output Queue. Reading all messages in the output queue will clear the message available bit.	

Standard Event The Event Status bit is set if an “enabled” event in the Standard Event Status Event Register has occurred.

Master Summary/Service Request bit The Master Summary Status is used with the *STB? query. When the *STB? query is read the MSS bit is not cleared.

The Request Service bit is cleared when it is polled during a serial poll.

Output Queue

Description The Output queue stores output messages in a FIFO buffer until read. If the Output Queue has data, the MAV bit in the Status Byte Register is set.

Error Queue

Description The error queue is queried using the SYSTem:ERRor? command. The Error queue will set the “Error Queue” bit in the status byte register if there are any error messages in the error queue. If the error queue is full the last message will generate a “Queue overflow” error and additional errors will not be stored. If the error queue is empty, “No error” will be returned.

Error messages are stored in the error queue in a first-in-first-out order. The errors messages are character strings that can contain up to 255 characters.

APPENDIX

Fuse Replacement

- Procedure
4. Remove the power cord and remove the fuse socket using a minus driver.

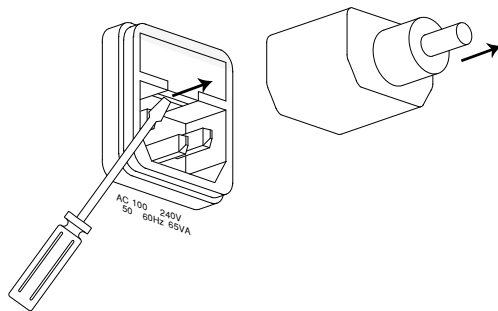

5. Replace the fuse in the holder.

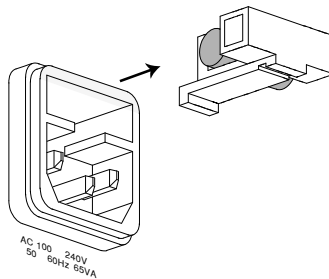

Ratings T0.63A, 250V

AFG-3000 Series Specifications

The specifications apply when the function generator is powered on for at least 30 minutes under +20°C~+30°C.

Waveforms	AFG-3051	AFG-3081	
	Sine, Square, Ramp, Pulse, Noise, DC, Sin(x)/x, Exponential Rise, Exponential Fall, Negative Ramp		
Arbitrary Waveforms			
	ARB Function	Built in	
	Sample Rate	200 MSa/s	
	Repetition Rate	100MHz	
	Waveform Length	1M points	
	Amplitude	16 bits	
	Resolution		
	Non-Volatile Memory	Ten 1M waveforms(1)	
	User defined Output Section	Any section from 2 to 1M points	
	User defined Mark Output	Any section from 2 to 1M points	
	Output mode	1 to 1048575 cycles or Infinite mode selectable	
Frequency Characteristics			
Range	Sine	50MHz	80MHz
	Square	50MHz	80MHz
	Triangle, Ramp		1MHz
Resolution		1μHz	
Accuracy	Stability	±1 ppm 0 to 50°C	
		±0.3 ppm 18 to 28°C	
	Aging	±1 ppm, per 1 year	
	Tolerance	≤1 μHz	
Output Characteristics(2)			
Amplitude	Range	10 mVpp to 10 Vpp(into 50Ω)	
		20 mVpp to 20 Vpp(open-circuit)	
	Accuracy	± 1% of setting ±1 mVpp (at 1 kHz,>10 mVpp)	
	Resolution	0.1 mV or 4 digits	

	Flatness	± 1% (0.1dB) <10 MHz ± 2% (0.2 dB) 10 MHz to 50 MHz ± 10% (0.9 dB) 50 MHz to 70 MHz ± 20% (1.9 dB) 70 MHz to 80 MHz (sine wave relative to 1 kHz)
Offset	Units	Vpp, Vrms, dBm,
	Range	±5 Vpk ac +dc (into 50Ω) ±10Vpk ac +dc (Open circuit)
Waveform Output	Accuracy	1% of setting + 2 mV + 0.5% Amplitude
	Impedance	50Ω typical (fixed) > 10MΩ (output disabled)
	Protection	Short-circuit protected Overload relay automatically disables main output
Sync Output	Level	TTL-compatible into>1kΩ
	Impedance	50Ω nominal
Sine wave Characteristics		
	Harmonic distortion(5)	-60 dBc DC~1 MHz, Ampl<3 Vpp -55 dBc DC~1 MHz, Ampl>3 Vpp -45 dBc 1MHz~5 MHz, Ampl>3 Vpp -30 dBc 5MHz~80 MHz, Ampl>3 Vpp
	Total Harmonic Distortion	< 0.2%+0.1mVrms DC to 20 kHz
	Spurious (non-harmonic)(5)	-60 dBc DC~1 MHz -50 dBc 1MHz~20MHz -50 dBc+ 6 dBc/octave 1MHz~80MHz
	Phase Noise	< -65dBc typical 10MHz, 30 kHz band < -47dBc typical 80MHz, 30 kHz band
Square wave Characteristics		
	Rise/Fall Time	<8 ns(3)
	Overshoot	<5%
	Asymmetry	1% of period +1 ns
	Variable duty Cycle	20.0% to 80.0% ≤ 25 MHz 40.0% to 60.0% 25~50MHz 50.0%(Fixed) 50~80MHz
	Jitter	0.01%+525ps < 2 MHz 0.1%+75ps > 2 MHz
Ramp Characteristics		
	Linearity	< 0.1% of peak output
	Variable Symmetry	0% to 100%
Pulse Characteristics		
	Period	20ns~ 2000s

	Pulse Width	8ns ~ 1999.9s Minimum Pulse Width: 8nS when $FREQ \leq 50MHz$ 5% of setting period when $FREQ \leq 6.5MHz$ Resolution: 1nS when $FREQ \leq 50MHz$ 1% of setting period when $FREQ \leq 6.5MHz$
	Overshoot	<5%
	Jitter	100 ppm +50 ps
AM Modulation		
	Carrier Waveforms	Sine, Square, Triangle, Ramp, Pulse, Arb
	Modulating Waveforms	Sine, Square, Triangle, Up/Dn Ramp
	Modulating Frequency	2 mHz to 20 kHz
	Depth	0% to 120.0%
	Source	Internal / External
FM Modulation		
	Carrier Waveforms	Sine, Square, Triangle, Ramp
	Modulating Waveforms	Sine, Square, Triangle, Up/Dn Ramp
	Modulating Frequency	2 mHz to 20 kHz
	Peak Deviation	DC to 50 MHz DC to 80 MHz
	Source	Internal / External
PWM		
	Carrier Waveforms	Square
	Modulating Waveforms	Sine, Square, Triangle, Up/Dn Ramp
	Modulating Frequency	2 mHz to 20 kHz
	Deviation	0% ~ 100.0% of pulse width
	Source	Internal / External
FSK		
	Carrier Waveforms	Sine, Square, Triangle, Ramp, Pulse
	Modulating Waveforms	50% duty cycle square
	Internal Rate	2 mHz to 100 kHz
	Frequency Range	DC to 50 MHz DC to 80 MHz
	Source	Internal / External
Sweep		
	Waveforms	Sine, Square, Triangle, Ramp
	Type	Linear or Logarithmic

	Direction	Up or Down
	Start/Stop Freq	100 μ Hz to 50 MHz 100 μ Hz to 80 MHz
	Sweep Time	1 ms to 500 s
	Trigger	Single, External, Internal
	Marker	Falling edge of Mark signal (Programmable frequency)
	Source	Internal / External
Burst		
	Waveforms	Sine, Square, Triangle, Ramp
	Frequency	1 μ Hz to 50 MHz(4) 1 μ Hz to 80 MHz(4)
	Burst Count	1 to 1000000 cycles or Infinite
	Start/Stop Phase	-360.0 $^{\circ}$ to +360.0 $^{\circ}$
	Internal Period	1 ms to 500 s
	Gate Source	External Trigger
	Trigger Source	Single, External or Internal Rate
Trigger Delay	N-Cycle, Infinite	0s to 85 s
External Modulation Input		
	Type	For AM, FM, Sweep, PWM
	Voltage Range	\pm 5V full scale
	Input Impedance	10k Ω
	Frequency	DC to 20kHz
External Trigger Input		
	Type	For FSK, Burst, Sweep
	Input Level	TTL Compatibility
	Slope	Rising or Falling (Selectable)
	Pulse Width	>100ns
	Input Impedance	10k Ω , DC coupled
Latency	Sweep	<10us (typical)
	Burst	<100ns (typical)
Jitter	Sweep	2.5 us
	Burst	1 ns; except pulse, 300 ps
Modulation Output		
	Type	For AM, FM, Sweep, PWM
Amplitude	Range	\geq 1Vpp
	Impedance	> 10k Ω typical (fixed)
Trigger Output		
	Type	For Burst, Sweep
	Level	TTL Compatible into 50 Ω
	Pulse Width	>450 ns
	Maximum Rate	1 MHz
	Fan-out	\geq 4 TTL load
	Impedance	50 Ω Typical
Marker Output		
	Type	For ARB, Sweep

Level	TTL Compatible into 50Ω
Fan-out	≥4 TTL load
Impedance	50Ω Typical
Store/Recall	10 Groups of Setting Memories
Interface	GPIB, RS232, USB
Display	4.3 inch TFT LCD 480 × 3 (RGB) × 272

System Characteristics

Configuration Times (typical)	Function Change: Standard---->102ms Pulse----->660ms Built-In Arb->240ms Frequency Change: 24ms Amplitude Change: 50ms Offset Change: 50ms Select User Arb: < 2s for 1M points Modulation Change: < 200ms		
Arb Download Times (typical)	Binary Code		ASCII Code
	GPIB/RS232 (115 Kbps)	USB Device	USB Host
1M points	189 sec	34 sec	70 sec
512K points	95 sec	18sec	35 sec
256K points	49 sec	9 sec	18 sec
64K points	16 sec	3 sec	6 sec
16K points	7 sec	830 ms	1340 ms
8K points	6 sec	490 ms	780 ms
4K points	6 sec	365 ms	520 ms
2K points	5 sec	300 ms	390 ms

General Specifications

Power Source	AC100~240V, 50~60Hz
Power Consumption	65 VA
Operating Environment	Temperature to satisfy the specification : 18 ~ 28°C Operating temperature : 0 ~ 40°C Relative Humidity: ≤ 80%, 0 ~ 40°C ≤ 70%, 35 ~ 40°C Installation category : CAT II
Operating Altitude	2000 Meters

Dimensions (WxHxD)	Pollution Degree	IEC 61010 Degree 2, Indoor Use
	Storage Temperature	-10~70°C, Humidity: ≤70%
	Bench Top	265 (W) x 107 (H) x 374 (D)
	Weight	Approx. 4kg
	Safety Designed to	EN61010-1
	EMC Tested to	EN 55011, IEC-61326
Accessories	Test cable(GTL-110× 1), User Manual Compact Disk × 1, Quick Start Guide × 1, Power cord × 1	

- (1). A total of ten waveforms can be stored. (Every waveform can be composed of 1M points maximum.)
- (2). Add 1/10th of output amplitude and offset specification per °C for operation outside of 0°C to 28°C range (1-year specification).
- (3). Edge time decreased at higher frequency.
- (4). Sine and square waveforms above 25 MHz are allowed only with an “Infinite” burst count.
- (5). Harmonic distortion and Spurious noise at low amplitudes is limited by a -70 dBm floor.

EC Declaration of Conformity

We

GOOD WILL INSTRUMENT CO., LTD.

No.7-1, Jhongsing Rd., Tucheng City, Taipei County 236, Taiwan

GOOD WILL INSTRUMENT (SUZHOU) CO., LTD.

No. 69, Lushan Road, Suzhou New District Jiangsu, China

declares that the below mentioned product

AFG-3081, AFG-3051

Are herewith confirmed to comply with the requirements set out in the Council Directive on the Approximation of the Law of Member States relating to Electromagnetic Compatibility (2004/108/EC) and Low Voltage Equipment Directive (2006/95/EC). For the evaluation regarding the Electromagnetic Compatibility and Low Voltage Equipment Directive, the following standards were applied:

© EMC

EN 61326-1 : EN 61326-2-1:	Electrical equipment for measurement, control and laboratory use — EMC requirements (2006)	
Conducted and Radiated Emissions EN 55011: 2007+A2: 2007	Electrostatic Discharge EN 61000-4-2: 2009	
Current Harmonic EN 61000-3-2: 2006+A1: 2009+A2: 2009	Radiated Immunity EN 61000-4-3: 2006+A1: 2008	
Voltage Fluctuation EN 61000-3-3: 2008	Electrical Fast Transients IEC 61000-4-4: 2004+Corr.1 : 2006+Corr.2 : 2007	
-----	Surge Immunity EN 61000-4-5: 2006	
-----	Conducted Susceptibility EN 61000-4-6: 2009	
-----	Power Frequency Magnetic Field EN 61000-4-8: 1993+A1: 2001	
-----	Voltage Dips/ Interrupts EN 61000-4-11: 2004	

© Safety

Low Voltage Equipment Directive 2006/95/EC
Safety Requirements IEC/EN 61010-1: 2001

INDEX

Arbitrary waveforms.....	137	List of features	11
Built-In	138	Menu Tree	42
display	151	Modulation	65
editing	158	AM	67
inserting	138	Burst.....	108
Output	168	FM	75
saving	174	FSK.....	83
Beeper.....	133	PWM.....	90
Caution symbol.....	6	Operation	
Cleaning the instrument	8	Amplitude	63
Declaration of conformity	302	Frequency	61
Default settings	53	Noise Wave	61
Digital inputs.....	23	Offset	64
Display		Pulse width.....	59
diagram	18	Ramp	60
Disposal		Sine.....	56
symbol	7	Square.....	57
Disposal instructions.....	9	Triangle	58
DSO link.....	135	Operation keys	
EN61010		key overview	13
measurement category	7	Operation menu	55
pollution degree.....	9	Output arbitrary waveforms ..	168
Environment		Output indicators.....	14
safety instructions	8	Output terminals.....	15
Firmware.....	129	Power on/off	
Front panel diagram.....	13	safety instruction	7
Function keys		Power up.....	20
key overview	13	Quick reference	21
Fuse replacement.....	275, 295	Rear panel diagram	16
safety instruction	8	remote control	
GPIB		interface configuration	183
remote control interface	185	Remote interface.....	182
Ground		Error messages.....	275
symbol	6	functionality check.....	186
Help menu	24	SCPI registers	289
interface.....	183	screen lock	187
Language selection	132	Syntax	188
		terminal connection	186

RS-232C interface.....	184	Setting up the instrument	19
Screen capture.....	134	software download.....	186
Screen lock.....	187	Specifications.....	296
Secondary System Settings.....	121	UK power cord.....	10
Remote interface.....	125	Updating Firmware.....	129
System and Settings	129	USB	
Service operation		remote control interface	183
about disassembly	7	Warning symbol	6
Set output impedance	131		