

User Manual

BCS Series

Battery Charger/Simulator and DC Power Supply



Safety Summary

The following safety precautions apply to both operating and maintenance personnel and must be followed during all phases of operation, service, and repair of this instrument.

WARNING

Before applying power to this instrument:

- Read and understand the safety and operational information in this manual.
- Apply all the listed safety precautions.
- Verify that the voltage selector at the line power cord input is set to the correct line voltage. Operating the instrument at an incorrect line voltage will void the warranty.
- Make all connections to the instrument before applying power.
- Do not operate the instrument in ways not specified by this manual or by B&K Precision.

Failure to comply with these precautions or with warnings elsewhere in this manual violates the safety standards of design, manufacture, and intended use of the instrument. B&K Precision assumes no liability for a customer's failure to comply with these requirements.

Category rating

The IEC 61010 standard defines safety category ratings that specify the amount of electrical energy available and the voltage impulses that may occur on electrical conductors associated with these category ratings. The category rating is a Roman numeral of I, II, III, or IV. This rating is also accompanied by a maximum voltage of the circuit to be tested, which defines the voltage impulses expected and required insulation clearances. These categories are:

Category I (CAT I): Measurement instruments whose measurement inputs are not intended to be connected to the mains supply. The voltages in the environment are typically derived from a limited-energy transformer or a battery.

Category II (CAT II): Measurement instruments whose measurement inputs are meant to be connected to the mains supply at a standard wall outlet or similar sources. Example measurement environments are portable tools and household appliances.

Category III (CAT III): Measurement instruments whose measurement inputs are meant to be connected to the mains installation of a building. Examples are measurements inside a building's circuit breaker panel or the wiring of permanently-installed motors.

Category IV (CAT IV): Measurement instruments whose measurement inputs are meant to be connected to the primary power entering a building or other outdoor wiring.

 WARNING

Do not use this instrument in an electrical environment with a higher category rating than what is specified in this manual for this instrument.

 WARNING

You must ensure that each accessory you use with this instrument has a category rating equal to or higher than the instrument's category rating to maintain the instrument's category rating. Failure to do so will lower the category rating of the measuring system.

Electrical Power

This instrument is intended to be powered from a CATEGORY II mains power environment. The mains power should be 115 V RMS or 230 V RMS. Use only the power cord supplied with the instrument and ensure it is appropriate for your country of use.

Ground the Instrument

 WARNING

To minimize shock hazard, the instrument chassis and cabinet must be connected to an electrical safety ground. This instrument is grounded through the ground conductor of the supplied, three-conductor AC line power cable. The power cable must be plugged into an approved three-conductor electrical outlet. The power jack and mating plug of the power cable meet IEC safety standards.

 WARNING

Do not alter or defeat the ground connection. Without the safety ground connection, all accessible conductive parts (including control knobs) may provide an electric shock. Failure to use a properly-grounded approved outlet and the recommended three-conductor AC line power cable may result in injury or death.

 WARNING

Unless otherwise stated, a ground connection on the instrument's front or rear panel is for a reference of potential only and is not to be used as a safety ground. Do not operate in an explosive or flammable atmosphere.

 WARNING

Do not operate the instrument in the presence of flammable gases or vapors, fumes, or finely-divided particulates.

 WARNING

The instrument is designed to be used in office-type indoor environments. Do not operate the instrument

- In the presence of noxious, corrosive, or flammable fumes, gases, vapors, chemicals, or finely-divided particulates.
- In relative humidity conditions outside the instrument's specifications.
- In environments where there is a danger of any liquid being spilled on the instrument or where any liquid can condense on the instrument.
- In air temperatures exceeding the specified operating temperatures.
- In atmospheric pressures outside the specified altitude limits or where the surrounding gas is not air.
- In environments with restricted cooling air flow, even if the air temperatures are within specifications.
- In direct sunlight.

This instrument is intended to be used in an indoor pollution degree 2 environment. The operating temperature range is 0°C to 40°C and 20% to 80% relative humidity, with no condensation allowed. Measurements made by this instrument may be outside specifications if the instrument is used in non-office-type environments. Such environments may include rapid temperature or humidity changes, sunlight, vibration and/or mechanical shocks, acoustic noise, electrical noise, strong electric fields, or strong magnetic fields.

Do not operate instrument if damaged** WARNING**

If the instrument is damaged, appears to be damaged, or if any liquid, chemical, or other material gets on or inside the instrument, remove the instrument's power cord, remove the instrument from service, label

it as not to be operated, and return the instrument to B&K Precision for repair. Notify B&K Precision of the nature of any contamination of the instrument.

Clean the instrument only as instructed

! WARNING

Do not clean the instrument, its switches, or its terminals with contact cleaners, abrasives, lubricants, solvents, acids/bases, or other such chemicals. Clean the instrument only with a clean dry lint-free cloth or as instructed in this manual. Not for critical applications

! WARNING

This instrument is not authorized for use in contact with the human body or for use as a component in a life-support device or system.

Do not touch live circuits

! WARNING

Instrument covers must not be removed by operating personnel. Component replacement and internal adjustments must be made by qualified service-trained maintenance personnel who are aware of the hazards involved when the instrument's covers and shields are removed. Under certain conditions, even with the power cord removed, dangerous voltages may exist when the covers are removed. To avoid injuries, always disconnect the power cord from the instrument, disconnect all other connections (for example, test leads, computer interface cables, etc.), discharge all circuits, and verify there are no hazardous voltages present on any conductors by measurements with a properly-operating voltage-sensing device before touching any internal parts. Verify the voltage-sensing device is working properly before and after making the measurements by testing with known-operating voltage sources and test for both DC and AC voltages. Do not attempt any service or adjustment unless another person capable of rendering first aid and resuscitation is present.

Do not insert any object into an instrument's ventilation openings or other openings.

! WARNING

Hazardous voltages may be present in unexpected locations in circuitry being tested when a fault condition in the circuit exists.

! WARNING

Fuse replacement must be done by qualified service-trained maintenance personnel who are aware of the instrument's fuse requirements and safe replacement procedures. Disconnect the instrument from

the power line before replacing fuses. Replace fuses only with new fuses of the fuse types, voltage ratings, and current ratings specified in this manual or on the back of the instrument. Failure to do so may damage the instrument, lead to a safety hazard, or cause a fire. Failure to use the specified fuses will void the warranty.

Servicing

WARNING

Do not substitute parts that are not approved by B&K Precision or modify this instrument. Return the instrument to B&K Precision for service and repair to ensure that safety and performance features are maintained.

For continued safe use of the instrument

- Do not place heavy objects on the instrument.
- Do not obstruct cooling air flow to the instrument.
- Do not place a hot soldering iron on the instrument.
- Do not pull the instrument with the power cord, connected probe, or connected test lead.
- Do not move the instrument when a probe is connected to a circuit being tested.

Compliance Statements

Disposal of Old Electrical & Electronic Equipment (Applicable in the European Union and other European countries with separate collection systems)

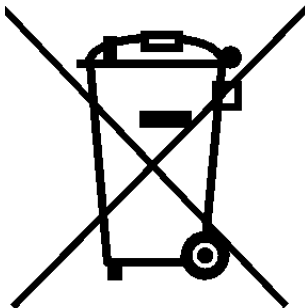

This product is subject to Directive 2002/96/EC of the European Parliament and the Council of the European Union on waste electrical and electronic equipment (WEEE), and in jurisdictions adopting that Directive, is marked as being put on the market after August 13, 2005, and should not be disposed of as unsorted municipal waste. Please utilize your local WEEE collection facilities in the disposition of this product and otherwise observe all applicable requirements.



Safety Symbols











Symbol	Description
	Indicates a hazardous situation which, if not avoided, will result in death or serious injury.
	Indicates a hazardous situation which, if not avoided, could result in death or serious injury.
	Indicates a hazardous situation which, if not avoided, will result in minor or moderate injury.
	Refer to the text near the symbol.
	Electric Shock hazard
	Alternating current (AC)
	Chassis ground
	Earth ground
	Indicates the In position of the power switch when instrument is ON.
	Indicates the Out position of the power switch when instrument is OFF.
	Indicates practices not related to physical injury.

Table 1 Safety Symbols

Contents

1	Introduction	11
1.1	Product Overview	11
1.2	Contents	12
1.3	Features	12
1.4	Dimensions	13
1.5	Front Panel	14
1.6	Rear Panel	15
2	Getting Started	16
2.1	Input Power and Fuse Requirements	16
2.2	Fuse Requirements	17
2.3	Check or Replace Fuse	17
3	Basic Front Panel Operations	19
3.1	Keys	19
3.1.1	Function Keys	19
3.1.2	Softkeys	20
3.1.3	Numeric Keypad	20
3.1.4	Navigation Keys	21
3.2	Display	22
3.2.1	Menu	22
4	Source	23
4.1	Source Parameters	23
4.2	Output	24
4.2.1	Channel	24
4.2.2	Output Parameters	24
4.3	View	25
4.3.1	Measure	26
4.4	Graph	28
4.5	Save	28
4.6	Recall	29
4.7	Prot Clr	29
5	Config	30
5.1	Config1	30
5.1.1	Output Speed	31
5.1.2	Voltage Range	32
5.1.3	Current Sense	33
5.1.4	Over Voltage Protection	34

5.1.5	Voltage Limit	35
5.1.6	Current Limit	36
5.1.7	Output Delay	37
5.2	Conf 2	38
5.2.1	Output-off State	39
5.2.2	Over Current Protection	40
5.2.3	Trace State	41
5.2.4	Trigger Mode	42
5.2.5	Ext_ON/OFF Mode	43
5.2.6	Ext_ON/OFF State	44
5.2.7	Digital Function	45
5.3	Conf 3	46
5.3.1	Current Low Range	47
6	Graph	48
6.1	Channel	49
6.2	Scope	49
6.3	Knob	50
6.4	Trig Set	51
6.5	Auto	52
6.6	V_Range	52
6.7	I_Range	53
6.8	Run/Hold	54
7	Battery	55
7.1	Start	56
7.2	Channel	56
7.3	Mode	56
7.4	Config	59
7.5	Capacity Clear	61
7.6	Manual	61
8	List	64
8.1	List Setup	65
8.1.1	List Parameters	65
8.2	Edit List	66
8.2.1	Step Parameters	67
8.3	Sequence Sel	68
8.3.1	Running a List	69
8.3.2	External Import	70
9	Math	71
9.1	Filter	72
9.1.1	Filter Channel	72

9.1.2	Filter State	72
9.1.3	Filter Type	73
9.1.4	Sample Rate	74
9.1.5	Sample Count	74
9.2	Buffer	75
9.2.1	Buffer Channel	75
9.2.2	Buffer Size	75
9.2.3	Buffer Statistics	76
9.2.4	Buffer Mode	77
9.2.5	Auto Clear	78
9.2.6	Clear	79
9.2.7	Export to USB	79
10	System	80
10.1	Sys Log	81
10.2	Sys Conf	83
10.2.1	Date	83
10.2.2	Time	83
10.2.3	Brightness	84
10.2.4	Beep	84
10.2.5	System Reset	85
10.2.6	System Self-Test	86
10.2.7	System Protection Clear	87
10.3	Sys Info	88
10.4	Sys Comm	89
10.4.1	USBTMC	90
10.4.2	LAN	91
10.5	Sys Cal	93
11	Service Information	94
12	LIMITED THREE-YEAR WARRANTY	95

Introduction

1.1 Product Overview



BCS6401



BCS6402

Figure 1.1 Front View

The BCS6401 and BCS6402 battery charger/simulator and precision sources are optimized for testing low power batteries and battery-operated devices. Both models feature source/sink capabilities, a bipolar output, and variable output impedance to charge, discharge, or simulate low power batteries.

Model	BCS6401		BCS6402
Channels	2		1
Voltage		CH1	CH2
	High	±15 V	0 to 15 V
	Low	±9 V	0 to 9 V
Current(Source / Sink)	High	3 A	
	Low	5 A	
Power	45 W per channel		150 W

Table 1.1 Models

1.2 Contents

Please inspect the instrument mechanically and electrically upon receiving it. Unpack all items from the shipping carton, and check for any obvious signs of physical damage that may have occurred during transportation. Report any damage to the shipping agent immediately. Save the original packing carton for possible future reshipment. Every power supply is shipped with the following contents:

- 1 x BCS6401 or BCS6402
- 1 x AC Power Cord
- 1 x Certificate of Calibration

Note:

Ensure the presence of all the items above. Contact the distributor or B&K Precision if anything is missing.

1.3 Features

- Dual channel and dual range operation (BCS6401 only)
- Accurate Battery Simulation
- Oscilloscope waveform display (DSO)
- Ultrafast transient response time < 50us
- Ultrafast Voltage rising time up to 500us (full load)
- Current readback resolution up to 100nA
- Built-in high accuracy DVM
- Variable output impedance
- Relay out function achieves electrical isolation on terminals
- Overvoltage (OVP), overcurrent (OCP), and overtemperature (OTP)
- USB (USBTMC-compliant) and LAN interfaces standard

1.4 Dimensions

Model	BCS6401	BCS6402
Dimensions (W x H x D)	8.9" x 3.5" x 18.75" (226 x 88.2 x 476.26 mm)	
Weight	19.85lbs (9 kg)	17.64lbs (8 kg)

Table 1.2 Dimensions and Weight



Figure 1.2 Dimensions

1.5 Front Panel

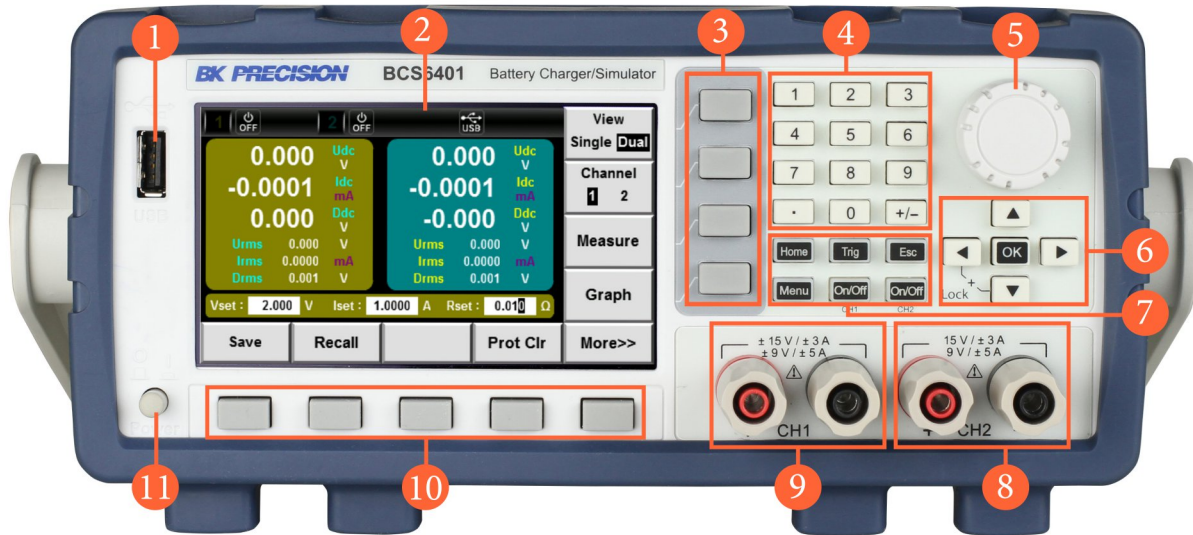

Figure 1.3 Front Panel

Item	Name	Description
1	USB Host Port	USB port used to connect external flash drives.
2	Display	Visual presentation of the device function and measurements.
3	Softkeys	Invoke any functions displayed in the right soft front panel menu.
4	Numeric Keypad	Enters numeric values. Press the [OK] to complete the entry.
5	Rotary Knob	Navigate through the control dialog windows or configure parameters.
6	Navigation Keys	Navigate through the control dialog windows. Press the [OK] key to select a control.
7	Function Keys	Frequently used function such as Home, Trig, Menu, ESC, and On/Off keys.
8	CH 2 Terminals	Serves as output or input terminals of CH 2 depending on the set functionality.
9	CH 1 Terminals	Serves as output or input of CH 1 depending on the set functionality.
10	Softkeys	Invoke any functions displayed in the bottom soft front panel menu.
11	Power Switch	Power the instrument ON or OFF .

Table 1.3 Front Panel

1.6 Rear Panel

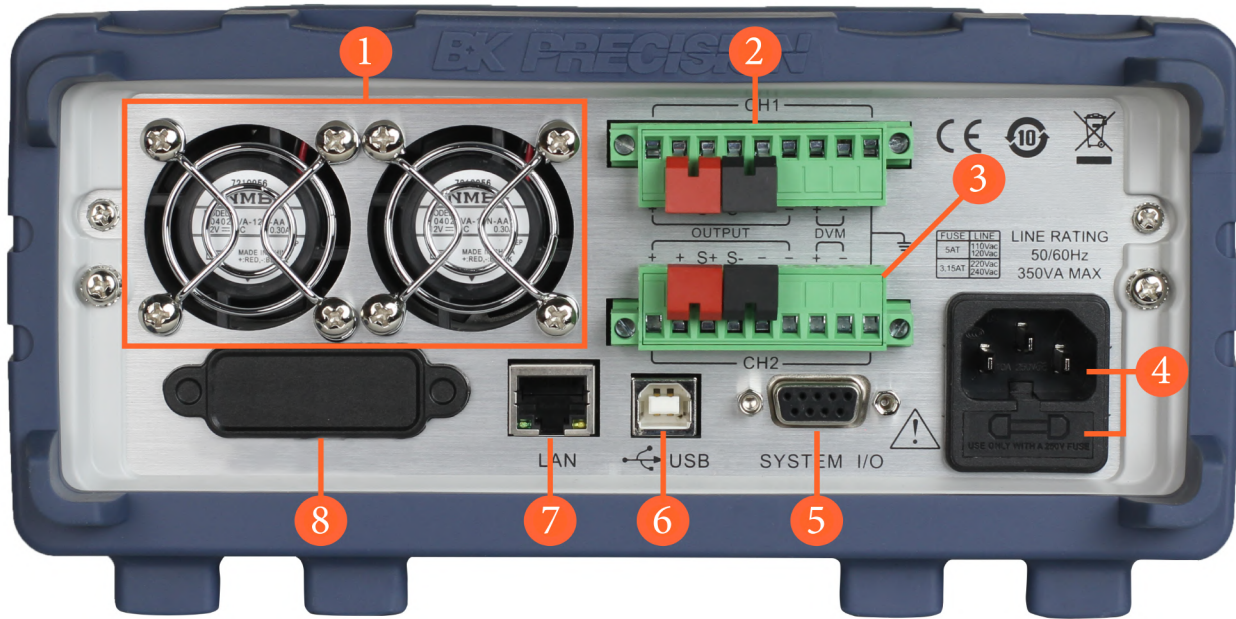

Figure 1.4 Rear Panel

Item	Name	Description
1	Vent Hole	Fan ventilation hole.
2	CH 1 Terminals	CH 1's sense line, DVM and output/input terminals.
3	CH 2 Terminals	CH 2's sense line, DVM and output/input terminals.
4	AC power input & fuse box	Houses the fuse-holder assembly and the AC inlet.
5	I/O Terminal	Digital I/O provides the Ext Trigger, Ext On/Off, DIGio and RIDFi functions.
6	USB port	Connect a USB type B to type A to remotely control the unit.
7	LAN port	Connect a Cat 5/6 Ethernet straight-through patch cable to remotely control the instrument.

Table 1.4 Front Panel

Getting Started

Before connecting and powering up the instrument, please review and go through the instructions in this chapter.

2.1 Input Power and Fuse Requirements

The supply has a universal AC input that accepts line voltage input within:

	BCS6401	BCS6402
Voltage	100 - 240 VAC (+/- 10 %)	
Frequency	50/60 Hz	
Input Power	350 VA MAX	500 VA MAX

Table 2.1 Line Rating

Before connecting to an AC outlet or external power source, be sure that the power switch is in the OFF position and verify that the AC power cord, including the extension line, is compatible with the rated voltage/current and that there is sufficient circuit capacity for the power supply. Once verified, connect the cable firmly.



The included AC power cord is safety certified for this instrument operating in rated range. To change a cable or add an extension cable, be sure that it can meet the required power ratings for this instrument. Any misuse with wrong or unsafe cables will void the warranty.

2.2 Fuse Requirements

An AC input fuse is necessary when powering the instrument. The below table shows the fuse requirements.

	Line	Fuse
BCS6401	110 / 220 Vac	5 AT
	220 / 240 Vac	3.15 AT
BCS6402	110 / 220 Vac	5 AT
	220 / 240 Vac	2.5 AT

Table 2.2 Fuse Requirements

2.3 Check or Replace Fuse

WARNING

For safety, no power should be applied to the instrument while changing line voltage operation. Disconnect all cables connected to the instrument before proceeding.

- Locate the fuse box next to the AC input connector in the rear panel. See [1.6](#)
- With a small flat blade screwdriver, insert into the fuse box slit to pull and slide out the fuse box as indicated below.
- Check and replace fuse if necessary (see figure [2.1](#)).

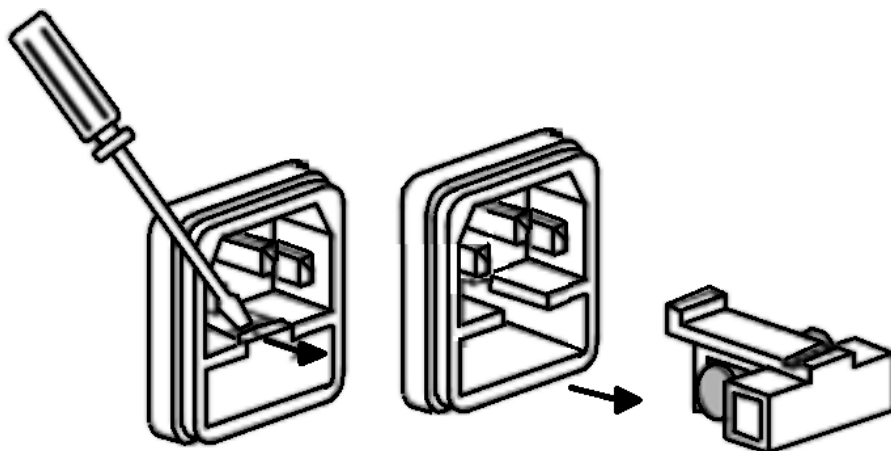

Figure 2.1 Fuse Removal

 **WARNING**

Any disassembling of the case or changing the fuse not performed by an authorized service technician will void the warranty of the instrument.

Basic Front Panel Operations

At power-on, the power supply will automatically enter the home page, where the power supply functionality can be configured.

3.1 Keys

The BCS6400 has four main key section:

- **Function Keys**
- **Numeric Keypad**
- **Softkeys**
- **Navigation Keys**

3.1.1 Function Keys



Figure 3.1 Function Keys

Key	Description
Home	Returns to home page. Source is set as the home page.
Trig	Triggers the defined events when trigger is set to manual.
ESC	Used to cancel a configuration or to exit a menu.
Menu	Opens the menu. See Figure 3.5 to view the available menu pages.
On/Off	Used to toggle CH 1 output status.
On/Off	Used to toggle Ch 2 output status.

Table 3.1 Function Keys

3.1.2 Softkeys

The unit has two sets of **Softkeys**. The first set are located below the display and consist of 5 horizontal softkeys. These keys will be referred to as **F1- F5** from left to right. The second set are located to the right of the display and consist of 4 vertical softkeys. These keys will be referred to as **F6-F9** from top to bottom.



Figure 3.2 Softkeys

3.1.3 Numeric Keypad

The numeric keys allow the configuration of various parameters. Using the numeric keys provides a fast and precise input. The \pm assigns the polarity of the set value.



Figure 3.3 Numeric Keypad

3.1.4 Navigation Keys

The navigation keys are used to navigate all available menus. The navigation keys can also be used to select the decimal place of a value currently being configured.



Figure 3.4 Navigation Keys

3.2 Display

The BCS6400 has 8 interfaces consisting of :

- **Menu**
- **Source**
- **Graph**
- **Battery**
- **List**
- **Math**
- **Config**
- **System**

Click on the corresponding interface for more information.

3.2.1 Menu

Press the **Menu** key to enter the **Menu Interface**.

The **Menu Interfaces** contains 7 icons which can be navigated using the navigation keys, the rotary knob, or with the softkey below the display. Press either the **OK** button or the softkey **F5** to navigate to the menu of the selected icon.

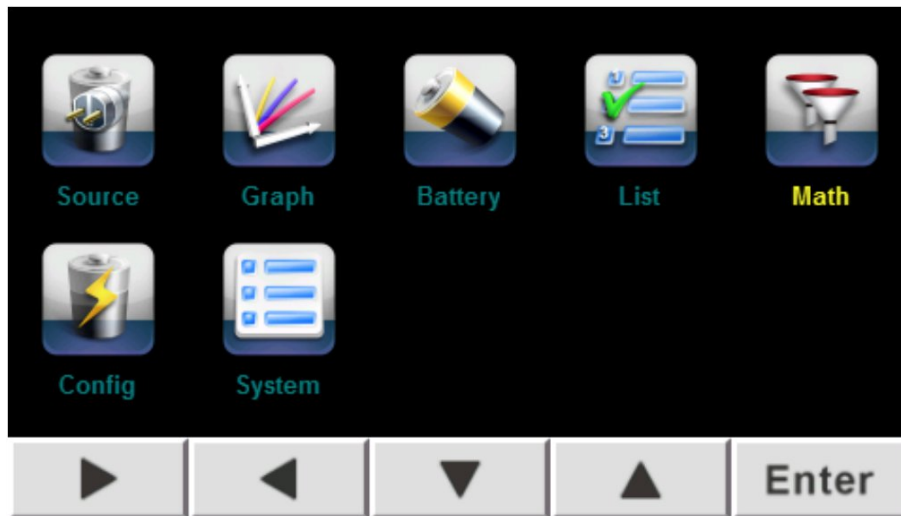

Figure 3.5 Menu Interface

Source

The source interface is used to provide the functionality of a power supply, as well as precise measurements.

To enter the **Source** interface press the **Home** button or select the  icon in the **Menu** interface.

4.1 Source Parameters

The following parameters can be configured in the **Source** interface.

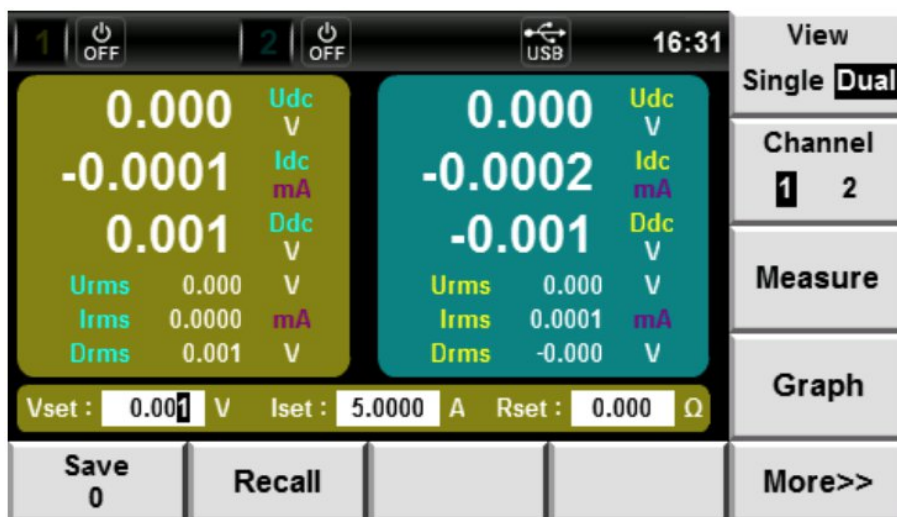

Figure 4.1 Source Display

Setting	Description
Output	Set the output parameters.
View	Set the view display view.
Channel	Select the channel to interact with.
Measure	Select the measurements to be displayed .
Graph	Navigate to the Graph Interface.
Save	Save the set parameters to internal memory
Recall	Recall previously saved parameters

Table 4.1

4.2 Output

Both channels have adjustable voltage, current, and resistance. The variable resistance can be used to simulate the internal resistance of batteries. This allows for precise simulation of a battery's output.

4.2.1 Channel

Press the **F7** softkey to toggle between channel 1 and 2. The display will

When **View** is set to **Single** the display will toggle between each channel. CH 1 will be displayed with a yellow background and CH2 will be displayed with a blue background.

When **View** is set to **Dual** the background color of the **Parameter Configuration Bar** will toggle to illustrate the selected channel. (Yellow for channel 1 and blue for channel 2)

4.2.2 Output Parameters

To set the channel's output parameters:

- Use the ▲ ▼ navigation keys along to cycle between the parameters.
 - The up key will move to the parameter left of the currently selected parameter.
 - The down key will move to the parameter right of the currently selected parameter.
- Use the numeric keypad to input a new value.
 - To modify a specific decimal point use the right and left arrow keys to navigate to the decimal point of the selected parameter.
 - Once the desired decimal point is selected the rotary knob is used to increase or decrease the number.

Refer to the **Models Table** to view the ranges of each instrument's parameter.

To set the range of the channel see section **5.1.2**.

4.3 View

Press the **F6** softkey to toggle the display mode between **Single** and **Dual**.



Figure 4.2 Single View CH 1



Figure 4.3 Dual View

Display up to 10 selected measurements of the selected channel. Four of the selected measurements can be set as the main measurements.

The main measurements will have a larger font taking up approximately half of the section displaying the measurement values.

Display up to 6 selected measurements for both channels. Three of the selected measurements can be set as the main measurements for each channel.

The main measurements will have a larger font taking up approximately half of the section displaying the measurement values.

The available measurement can be found in section [4.3.1](#)

4.3.1 Measure

Press the **F8** softkey to select the **Measure** submenu.

The measure parameters for **Single** and **Dual View** are independent. Therefore, measurements set in **Single View** will not transfer to the displayed measurements in **Dual View**.

The measurement parameters are broken into three groups: **Voltage [U]**, **Current [I]**, and **DVM [D]**.

While in the Measure submenu press the **F1** softkey to toggle between each group.

Press the **F1** softkey to toggle between the available measurements. **U**, **I**, and **D**.

Use the **F6** and **F7** softkeys to toggle between the available statistics of the selected measurements.

See table 4.2 for the available for the available parameters

Parameter	Description
U	
Udc	Average of all voltages measured
Umax	Maximum measured voltage
Umin	Minimum measured voltage
Urms	Voltage effective value
Uhigh	High measured voltage
Ulow	Low measured voltage
I	
Idc	Average of all currents measured
Irms	Current effective value
Imax	Maximum measured current
Imin	Minimum measured current
Ihigh	High measured current
Ilow	Low measured current
D	
Ddc	DVM average of all measuredments
P	Measured power
Drms	DVM voltage effective value

Table 4.2 Measure Parameters

Single View

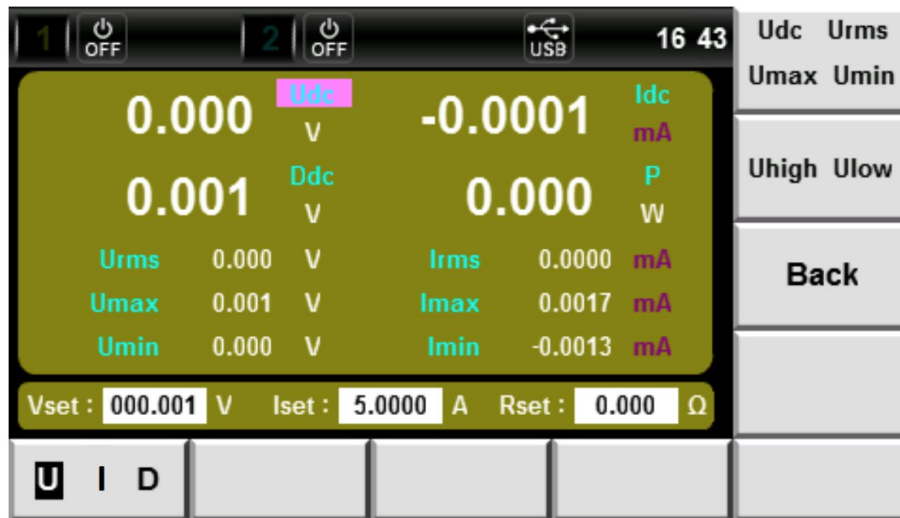

Figure 4.4 Measure Single View

To replace a measurement :

1. Press the **F7** softkey to select the channel that will be modified.
2. Press the **F8** softkey to enter the **Measure** submenu.
3. Use the **Up** and **Down** navigation keys to select the measurement you want to replace.
 - The selected parameter will be highlighted in black and the font color will change to purple
4. Press the **F1** softkey to selected the corresponding group of the new parameter.
5. Press the **F6** or **F7** softkey to select the desired parameter.
6. Press the **OK** button to set the new parameter

Dual View



Figure 4.5 Measure Dual View

To replace a measurement :

1. Press the **F8** softkey to enter the **Measure** submenu.
2. Use the **Up** and **Down** navigation keys to select the measurement you want to replace.
 - To edit the parameters of channel 2 press the **Down** navigation key until the select cursor switched to the CH 2 section.
 - The selected parameter will be highlighted in black and the font color will change to purple
3. Press the **F1** softkey to selected the corresponding group of the new parameter.
4. Press the **F6** or **F7** softkey to select the desired parameter.
5. Press the **OK** button to set the new parameter

4.4 Graph

Press the **F9** softkey to navigate to the **Graph Interface**. For more information read the Graph Interface chapter.

4.5 Save

In the **Source Interface** press **F1** to **Save** the set output parameters.

Once the configuration has been saved the saved addressed will be displayed beneath the **Save** text.

The unit can store up to 50 configurations. (0 to 49)

4.6 Recall

In the **Source Interface** press **F2** to enter the **Recall** submenu.



Figure 4.6 Recall Submenu

To recall a configuration:

1. Select the channel to be configured.(Press the **F7** softkey to toggle between the channels.)
2. Press the **▲▼** buttons to navigate the configuration list.
3. Press the **F4** softkey to load the selected configuration.

To deleted saved parameters :

- Enter the **Recall** menu.
- Use the **▲▼** navigation keys to a point.
- Press the **F3** softkey to deleted the parameters saved at the chosen point.

4.7 Prot Clr

The **F4** softkey clears all the protection triggers. To configure and set the state of the available protection features refer to the **Config** chapter.

Config

To enter the **Configuration Interface**:

Press the **Menu** button then use the navigation keys to select the  icon.

5.1 Config1

In the **Config1** menu the source parameters' parameters can be configured. Parameters such as the outputs' speed, range, protections, limits, and delays can be configured. To enter the **Config1** menu:

Press the **Menu** button then select **Config > Conf 1**.

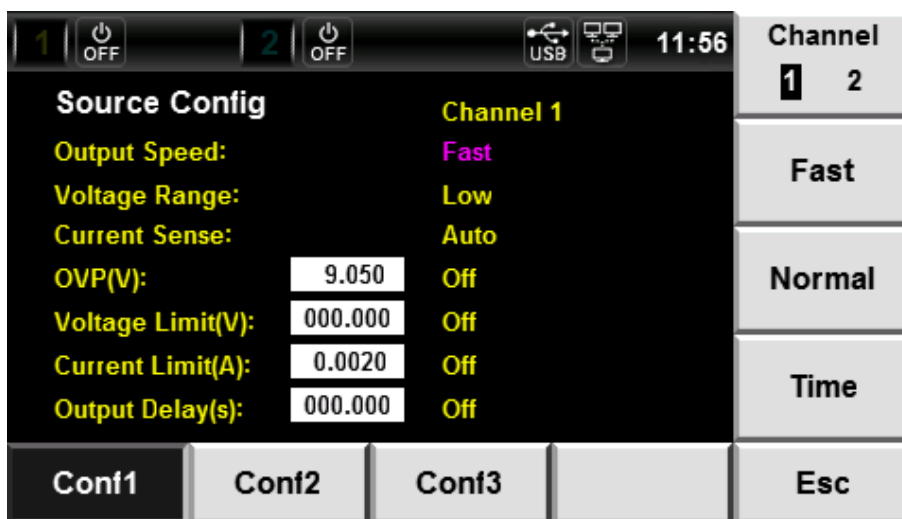

Figure 5.1 Source Config1

The following parameters can be configured in the **Configuration Interface**:

Setting	Description
Output Speed	Set the rising voltage slew rate.
Voltage Range	Set the voltage range.
Current Sense	Set the current sense mode.
OVP(V)	Enable/disable and set over voltage protection.
Voltage Limit(V)	Enable/disable and set the voltage limit.
Current Limit(A)	Enable/disable and set the current limit.
Output Delay	Enable/disable and set the output delay.

Table 5.1

5.1.1 Output Speed

The output speed, also known as voltage slew, sets the rate at which the output increases until the set voltage is reached. The slew rate can be implemented for device that may be damage by sudden changes in voltages.

To configure the output speed:

1. Press the **Menu** button then select **Config** to enter the **Configuration Interface**.
2. Press the **F1** softkey to select the **Conf 1** menu.
3. Press the **F6** softkey to select the channel to be configured.
4. Use the **▲▼** keys to select the **Output Speed** setting.
5. Press the softkey corresponding to desired mode.

The following modes are available:

Fast Mode (F7 Softkey)

Fast Mode allows for a maximum rise time of 500 us.

Normal Mode (F8 Softkey)

Normal Mode allows for a maximum rise time of 5 ms.

Time Mode (F9 Softkey)

Once **Time Mode** is selected press the **▲** button to edit the rise time. The numeric keypad or the rotary knob can be used to set the rise time.

- The rise time can be set from 1 ms to 86400 s.

The rate at which the output increases is determined by the set voltage and type.

$$SlewRate = \frac{V_{set}}{OutputTime}$$

Example If V_{set} is set to 2.000 V and Output Time is set to 10 s the voltage will increase at a rate of .2 V/s .

5.1.2 Voltage Range

To configure the output rise time:

1. Press the **Menu** button then select **Config** to enter the **Configuration Interface**.
2. Press the **F1** softkey to select the **Conf 1** menu.
3. Press the **F6** softkey to select the channel to be configured.
4. Use the **▲▼** keys to select the **Voltage Range** setting.
5. Press the softkey corresponding to desired mode.

The following modes are available:

High Range (F7 Softkey)

BCS6401		
Channel	Range	Voltage
CH 1	High	-15 to 15 V
CH 2	High	0 to 15 V

Table 5.2 BCS6401 High Voltage Range

Low Range (F8 Softkey)

BCS6401		
Channel	Range	Voltage
CH 1	Low	-9 to 9 V
CH 2	Low	0 to 9 V

Table 5.4 BCS6401 Low Voltage Range

BCS6402	
Range	Voltage
High	-30 to 30 V

Table 5.3 BCS6402 High Voltage Range

BCS6402	
Range	Voltage
Low	-30 to 30 V

Table 5.5 BCS6402 Low Voltage Range

5.1.3 Current Sense

Current sensing is used for both protection and measurement.

To configure the **Current Sense** mode:

1. Press the **Menu** button then select **Config** to enter the **Configuration Interface**.
2. Press the **F1** softkey to select the **Conf 1** menu.
3. Press the **F6** softkey to select the channel to be configured.
4. Use the **▲▼** keys to select the **Current Sense** setting.
5. Press the softkey corresponding to desired mode.

The following modes are available:

High

To select **High Range** press **F7**.

Auto

To select **Auto Range** press **F8**.

The unit will automatically switch between **Low** and **High Range**. When the current is lower than 5 mA **Current Sense** will change to Low Range.

The measurement precision is .005% + 2 uA with a resolution ratio of .1 uA.

5.1.4 Over Voltage Protection

To configure the Over Voltage Protection(OVP):

1. Press the **Menu** button then select **Config** to enter the **Configuration Interface**.
2. Press the **F1** softkey to select the **Conf 1** menu.
3. Press the **F6** softkey to select the channel to be configured.
4. Use the **▲▼** keys to select the **OVP(V)** setting.
5. Press the softkey corresponding to desired state.

The following states are available:

On



To select the **On State** press **F7**.The icon  will be displayed to the right of the output state of the selected channel. See figure 5.2.



Figure 5.2 OVP Status On

Once the **On State** is selected press the **▲** button to set the **OVP** value. The numeric keypad or the rotary knob can be used to set the rise time.

The **OVP** trigger point can be set between 0 to 15 V.

When **OVP** is trigger the output will be disabled and the icon  will be displayed to the right of the output state of the selected channel. See figure 5.3.

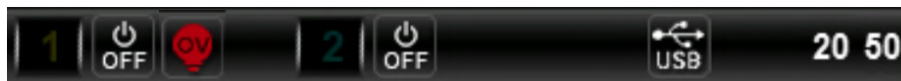

Figure 5.3 OVP Triggered

Off

To select the **Off State** press **F8**.

The unit has a **Hardware Over Voltage Protection** to avoid damage to the internal components when **OVP** is disabled.

The trigger point for **Hardware Over Voltage Protection** is approximately 120% of the specified maximum voltage.

When **Hardware OVP** is triggered the output will be disabled and the icon  will be displayed to the right of the output state of the selected channel. See figure 5.4.





Figure 5.4 Hardware OVP Triggered

5.1.5 Voltage Limit

When enabled the **Voltage Limit** sets a specified limit on Vset. The limitation prevents accidental changes in Vset that may damage other devices connected to the source from occurring.

To configure the **Voltage Limit**:

1. Press the  button then select **Config** to enter the **Configuration Interface**.
2. Press the **F1** softkey to select the **Conf 1** menu.
3. Press the **F6** softkey to select the channel to be configured.
4. Use the   keys to select the **Voltage Limit(V)** setting.
5. Press the softkey corresponding to desired state.

The following states are available:

On (Softkey F7)

Once the **On State** is selected press the  button to set the **Voltage Limit(V)** value.

The numeric keypad or the rotary knob can be used to set the rise time.

Range: 0 to 15 V

When **Voltage Limit** is enabled the maximum **Vset** value will be limited to set limit. Unlike **OVP** the output will not shut off if the limit value is reached.



Off (Softkey F8)

When **Voltage Limit** is disabled the maximum **Vset** value will be the maximum voltage specified in the **Data Sheet**.

5.1.6 Current Limit

When enabled the **Current Limit** sets a specified limit on Iset. The limitation prevents accidental changes in Iset that may damage other devices connected to the source from occurring.

To configure the **Current Limit**:

1. Press the  button then select **Config** to enter the **Configuration Interface**.
2. Press the **F1** softkey to select the **Conf 1** menu.
3. Press the **F6** softkey to select the channel to be configured.
4. Use the   keys to select the **Current Limit(A)** setting.
5. Press the softkey corresponding to desired state.

The following states are available:

On

To select the **On State** press **F7**

Once the **On State** is selected press the  button to set the **Current Limit(A)** value.

The numeric keypad or the rotary knob can be used to set the rise time.

Range: 2 mA to 5.05 A

When **Current Limit** is enabled the maximum **Iset** value will be limited to set current limit.

Off

To select the **Off State** press **F8**.

When **Current Limit** is disabled the maximum **Iset** value will be the maximum current specified in the **Data Sheet**.

5.1.7 Output Delay

Output delays along with **Trace** can be used to create a particular power on sequence. This can be useful when powering devices that need a particular sequence such as ICs.

To configure the **Output Delay**:

1. Press the **Menu** button then select **Config** to enter the **Configuration Interface**.
2. Press the **F1** softkey to select the **Conf 1** menu.
3. Press the **F6** softkey to select the channel to be configured.
4. Use the **▲▼** keys to select the **Output Delay(s)** setting.
5. Press the softkey corresponding to desired state.

The following states are available:

On

To select the **On State** press **F7**

Once the **On State** is selected press the **▲** button to set the **Output Delay(s)** value.

The numeric keypad or the rotary knob can be used to set the rise time.

Range: 0 to 999.999 s

When **Output Delay** is enabled the output will not be enabled until the set time has elapsed.

Upon enabling the output the **On/Off** button of the corresponding channel will indicate that output is enabled for approximately a second. The unit will then again indicate that the output is disabled. For that brief second nothing will be output despite the On/Off button being illuminated. The output will not be enabled until the set delay time elapses.

Off

To select the **Off State** press **F8**.

When **Output Delay** is disabled the output will instantaneously be enabled once the **On/Off** button is pressed, or after the unit receives an on signal.

5.2 Conf 2

In the **Config2** menu the instrument's parameters can be configured. These parameters control the instrument's function and modes, and unlike the parameters in **Config1** they do not apply to only the specified channel.

To enter the **Config2** menu:

Press the **Menu** button then select **Config > Conf2**.

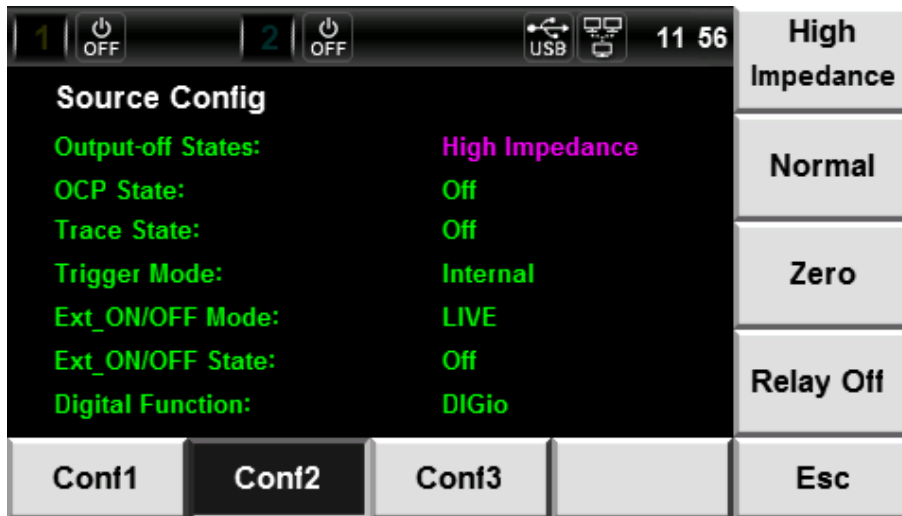

Figure 5.5 Source Config2

Setting	Description
Output-Off State	Set the impedance of the terminals when output is disabled.
OCP State	Enable/disable over current protection
Trace State	Enable/disable channel coupling.
Trigger Mode	Set the trigger mode.
Ext_ON/OFF Mode	Set the inhibit mode.
Ext_ON/OFF State	Set the inhibit state.
Digital Function	Set the Digital I/O function.

Table 5.6 Conf2

5.2.1 Output-off State

Set the resistance of the terminals after the output has been disabled.

To configure the **Output-off State**:

1. Press the **Menu** button then select **Config** to enter the **Configuration Interface**.
2. Press the **F2** softkey to select the **Conf 2** menu.
3. Use the **▲▼** keys to select the **Output-off State** setting.
4. Press the softkey corresponding to desired state.

The following states are available:

High Impedance

To select the **High Impedance** press **F7**.

After disabling the output the terminal impedance will be set to approximately 130 K Ω .

Normal

To select the **Normal** press **F8**.

After disabling the output the terminal impedance will be set to approximately 2 Ω .

The output current is approximately 4.6 mA.

Zero

To select the **Zero** press **F7**.

After disabling the output the terminal impedance will be set to approximately 2 Ω .

The output current is approximately 9.8 mA.

Relay Off

To select the **Relay Off** press **F8**.

After disabling the output the relay will disconnect the internal circuit and the external load.

The isolation impedance will be set to approximately 1 G Ω .

5.2.2 Over Current Protection

Over current protection protect the device from outputting current that will harm the instrument. This setting protects the BCS6402 unlike the current limit setting which protects devices connected to the BCS6402.

To configure the **Over Current Protection(OCP)**:

1. Press the **Menu** button then select **Config** to enter the **Configuration Interface**.
2. Press the **F1** softkey to select the **Conf 2** menu.
3. Press the **F6** softkey to select the channel to be configured.
4. Use the **▲▼** keys to select the **OCP State** setting.
5. Press the softkey corresponding to desired state.

The following states are available:

On

To select the **On State** press **F7**.The icon  will be displayed to the right of the output state of the selected channel. See figure 5.6.



Figure 5.6 OCP Status On

The maximum output current of the power supply will be limited to the present current set value (Iset).

The **OCP** trigger point can be set between 0 to 5 A when **Voltage Range** is set to low.

When **OCP** is trigger the output will be disabled and the icon  will be displayed to the right of the output state of the selected channel. See figure 5.7.



Figure 5.7 OCP Triggered

Off

To select the **Off State** press **F8**.

5.2.3 Trace State

Trace, also known as channel coupling, couples the 2 outputs causing them to turn on and off simultaneously. Combining **Trace** and **Output Delay** can create a power on sequence. Power on sequence can be used to power components that need specific sequences such as ICs.

To configure the **Trace State**:

1. Press the **Menu** button then select **Config** to enter the **Configuration Interface**.
2. Press the **F1** softkey to select the **Conf 2** menu.
3. Press the **F6** softkey to select the channel to be configured.
4. Use the **▲▼** keys to select the **Trace State** setting.
5. Press the softkey corresponding to desired state.

The following states are available:

On

To select the **On State** press **F7**.

Enabling **Trace State** couples the channels. Enabling a channel's output state will enable both output. Disabling a channel's output will disable both outputs.

Combine **Trace State** with **Output Delay** to toggle the outputs in a set sequence.

To configure a sequence:

1. Set voltage and current output of the participating channels.
Reference section Setting Voltage and Current.
2. Synchronize output state by coupling the channels.
Reference section **Trace State**
3. Configure the turn on order of the outputs using the **Output Delay**.
Reference section **Output Delay**

Begin the sequence by turning on any of the outputs.

Off

To select the **Off State** press **F8**.

5.2.4 Trigger Mode

Events can be triggered by means of: manual trigger (**Internal**), command trigger (**BUS**) and external signal trigger (**External**).

To set the **Trigger Mode**:

1. Press the **Menu** button then select **Config** to enter the **Configuration Interface**.
2. Press the **F1** softkey to select the **Conf 2** menu.
3. Press the **F6** softkey to select the channel to be configured.
4. Use the **▲▼** keys to select the **Trigger Mode** setting.
5. Press the softkey corresponding to desired state.

The following modes are available:

Internal

To select the **Internal Triggering** press **F7**.

Press the **Trig** button to manually trigger events.

BUS

To select the **BUS Triggering** press **F8**.

Commands sent through the selected remote interface will trigger events.

External

To select the **External Triggering** press **F9**.

External signals received through pins 1 and 6 of the **System I/O Interface** (DB9 terminal) will trigger events. A trigger will take place when a descending edge is registered.

5.2.5 Ext_ON/OFF Mode

1. Press the **Menu** button then select **Config** to enter the **Configuration Interface**.
2. Press the **F1** softkey to select the **Conf 2** menu.
3. Press the **F6** softkey to select the channel to be configured.
4. Use the **▲▼** keys to select the **Ext_ON/OFF Mode** setting.
5. Press the softkey corresponding to desired state.

The following modes are available:

LATCH

To select the **On State** press **F7**.

After the detection of level change (from high to low) at the external On/Off control terminals, the power supply output will be switched off. The unit will not output anything until the latch is released.

To release the latch :

- Send the command **OUTPut:PROTEction:CLEar**
or
- Press the **Menu** button then select **System > Sys Conf**
 - Use the **▲▼** to select **System Protection Clear**.
 - Press the right [Ok] softkey to release the latch mode.

LIVE

To select the **Off State** press **F8**.

The output state of power supply changes with the level of external On/Off control terminal. When the On/Off control terminal input is high-level, the power supply output is on; and when the external On/Off control terminal input is low-level, the power supply output is off.

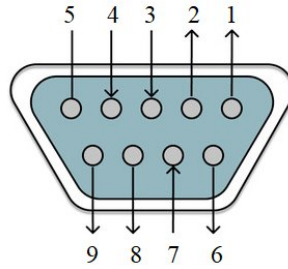

Figure 5.8
System I/O Interface Pins

Pin	Function
1	Ext_Trigger
2	Ext_On/Off
3	DIGio 1/RIDFi
4	DIGio 2/RIDFi
6 to 9	GND

Table 5.7 DB9 Pinout

5.2.6 Ext_ON/OFF State

1. Press the **Menu** button then select **Config** to enter the **Configuration Interface**.
2. Press the **F1** softkey to select the **Conf 2** menu.
3. Press the **F6** softkey to select the channel to be configured.
4. Use the **▲▼** keys to select the **Ext_ON/OFF State** setting.
5. Press the softkey corresponding to desired state.

The following states are available:

On

To select the **On State** press **F7**.

When **Ext_ON/OFF State** is enabled the output of both channels can be controlled using an external signal. See **Ext_ON/OFF Mode** for more information on.

Off

To select the **Off State** press **F8**.

When **Ext_ON/OFF State** the output status is controlled through the front panel or through a remote interface.

5.2.7 Digital Function

Pins 3 and 4 of the System I/O Interface are multiple terminals, which can be used as the common digital I/O interfaces. They can read and control the output terminal state through communication command, or they can be used for indicating power supply fault depending on the set mode

1. Press the **Menu** button then select **Config** to enter the **Configuration Interface**.
2. Press the **F1** softkey to select the **Conf 2** menu.
3. Press the **F6** softkey to select the channel to be configured.
4. Use the **▲▼** keys to select the **Digital Function** setting.
5. Press the softkey corresponding to desired state.

The following modes are available:

RIDFi

To select the **RIDFi** press **F7**.

Pins 3 and 4 will indicate the power supply fault.

The terminal sources is be divided into QUES, OPER, ESB, RQS and OFF.

- QUES: The EXT RIDFi terminal output level changes with the QUES bit of the state byte of the power supply.
 - When the QUES bit is 0, the RIDFi outputs low level. When the QUES bit is 1, the RIDFi outputs high level.
- OPER: The EXT RIDFi terminal output level changes with the OPER bit of the state byte of the power supply.
- ESB: The EXT RIDFi terminal output level changes with the ESB bit of the state byte of the power supply.
- RQS: The EXT RIDFi terminal output level changes with the RQS bit of the state byte of the power supply.
- OFF: The EXT RIDFi terminal output level keeps low

DIGio

To select the **DIGio** press **F8**.

DIGio1 (Pin 3) and DIGio2 (Pin 4) will be used as the common digital IO output terminals. The terminals can read and control the output state through communication command.

Under remote mode, the SCPI command (DIGital:DATA? and DIGital: DATA) can be sent to read and configure the output terminal state. High level is 5V and low level is 0V.

5.3 Conf 3

Press the **Menu** button then select **Config** to enter the **Configuration Interface**.

- The **F1-F3** softkeys select the corresponding menu.
- The **▲▼** keys navigate the available settings in each menu.
- The **F6 - F9** softkeys select the available state/mode of each settings.

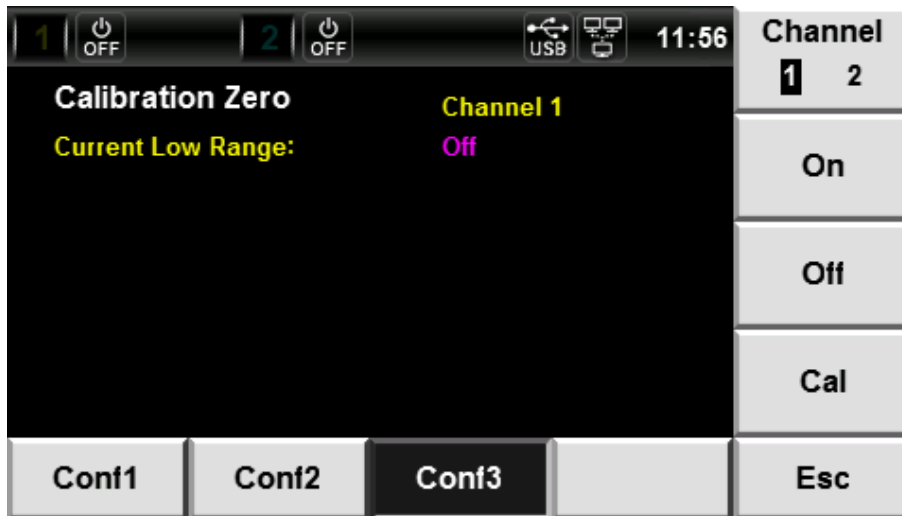

Figure 5.9 Source Config3

Before configuring any settings chose the channel to be configured. To select a channel press **F6** to toggle between Ch 1 and CH 2.

5.3.1 Current Low Range

1. Press the **Menu** button then select **Config** to enter the **Configuration Interface**.
2. Press the **F1** softkey to select the **Conf 3** menu.
3. Press the **F6** softkey to select the channel to be configured.
4. Use the **▲▼** keys to select the **Digital Function** setting.
5. Press the softkey corresponding to desired state.

The following modes are available:

On

To select the **On State** press **F7**.

The calibration function is turned on, operate the small current zero calibration)

Off

To select the **Off State** press **F8**.

Graph

The BCS6400 provides a waveform display of the measured sourced.



Figure 6.1 Graph Interface

To enter the **Graph Interface**:

Press the **Menu** button then use the navigation keys or the softkeys to select the  icon .

Setting	Description
Channel	Select the channel terminal
Scope	Select the parameters to be displayed on the scope
Knob	Select the parameter to be controlled using the rotary knob
Trig Set	Set the triggering parameters
Auto	Automatically adjusts the Scope settings to get a stable display
V_Range	Set the voltage range
I_Range	Set the current range
Run/Hold	Toggle between run and stop mode

Table 6.1 Graph Interface

6.1 Channel

Toggle between channel 1 and 2 by pressing the **F1** softkey in the **Graph Interface**

The settings corresponding to the softkeys **F6 to F8** are shared between channels.

The settings corresponding to the softkeys **F2 to F4** are not shared between channels.

6.2 Scope

1. Press the **Menu** button then select **Graph** to enter the **Graph Interface**.
2. Press the **F2** softkey to select the **Scope**.
3. Press the corresponding Softkey to select the available parameters.

The following parameters are available:

Volt

Press the **F6** softkey to toggle the voltage wave.

When enabled the ✓ will be highlighted.

When disabled the X will be highlighted.

Ampe

Press the **F7** softkey to toggle the current wave.

When enabled the ✓ will be highlighted.

When disabled the X will be highlighted.

DVM

Press the **F8** softkey to toggle the voltage wave.

When enabled the ✓ will be highlighted.

When disabled the X will be highlighted.

6.3 Knob

Assign a parameter to the rotary knob. When the Knob is rotated, the assigned parameter offset on the interface will be changed.

To assign a parameter to the rotary knob:

1. Press the  button then select **Graph** to enter the **Graph Interface**.
2. Press the **F3** softkey to select the **Knob**.
3. Press the corresponding Softkey to select the available parameters.

The following parameters are available:

Volt

When **Volt** is assigned to the rotary knob the grounding level of the voltage can be adjusted.

Ampe

When **Ampe** is assigned to the rotary knob the grounding level of the current can be adjusted.

DVM

When **DVM** is assigned to the rotary knob the grounding level of the DVM can be adjusted.

T/Lev

When **T/Lev** is assigned to the rotary knob the trigger level can be adjusted.

T/Del

When **T/Del** is assigned to the rotary knob the trigger delay can be adjusted.

When the knob is rotated, the trigger point will move horizontally and the delay time will be displayed on the screen. When the delay time is changed, the trigger point  will move horizontally, and the distance between the trigger point and the horizontal center will be indicated. The trigger point is displayed along the top of the display grid.

T/Div

When **T/Div** is assigned to the rotary knob the horizontal calibration can be adjusted.

The time/grid information changes can be observed on the screen by rotating the knob and changing the horizontal (time/grid) setting. When acquisition is run, the sampling rate can be changed by adjusting the horizontal calibration knob.

Range: 1 to 500 ms

6.4 Trig Set

To enable the trigger function:

1. Press the **Menu** button then select **Graph** to enter the **Graph Interface**.
2. Press the **F4** softkey to select the **Trig Set**.
3. Press the corresponding Softkey to select the available parameters.

The following parameters are available:

Source

Press the **F6** softkey to toggle between: **U**, **A**, and **DVM** trigger source.

Mode

Press the **F7** softkey to toggle between **Auto** and **Normal** trigger mode.

Slope

Press the **F8** softkey to toggle between rising edge \uparrow , falling edge \downarrow , or either edge $\uparrow\downarrow$.

Single

When single measurement is performed under stop conditions, a single measurement will be performed immediately and the stop condition will remain.

When single measurement is performed under running conditions, a single measurement will be performed immediately and then the stop status will be enabled.

6.5 Auto

1. Press the **Menu** button then select **Graph** to enter the **Graph Interface**.
2. Press the **F4** softkey to select the **Trig Set**.
3. Press the **F5** Softkey to automatically adjust the settings to obtain a stable signal display.

6.6 V_Range

To set a voltage range:

1. Press the **Menu** button then select **Graph** to enter the **Graph Interface**.
2. Press the **F6** softkey to select the **V_Range**.
3. Use the **▲ ▼** to navigate the available ranges.
 - Press the **OK** to select a range.

- 100 mV
- 200 mV
- 500 mV
- 1.0 V
- 2.0 V
- 5.0 V
- 10.0 V

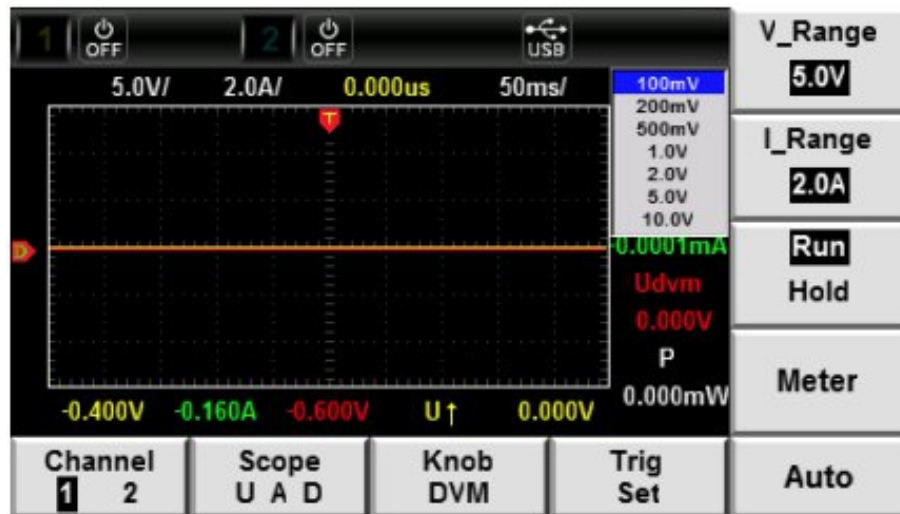

Figure 6.2 V Range

6.7 I_Range

To set a voltage range:

1. Press the **Menu** button then select **Graph** to enter the **Graph Interface**.
2. Press the **F7** softkey to select the **I_Range**.
3. Use the **▲▼** to navigate the available ranges.
 - Press the **OK** to select a range.

- 5.0 mA
- 10.0 mA
- 20.0 mA
- 50.0 mA
- 100.0 mA
- 200.0 mA
- 500.0 mA
- 1.0 A
- 2.0 A

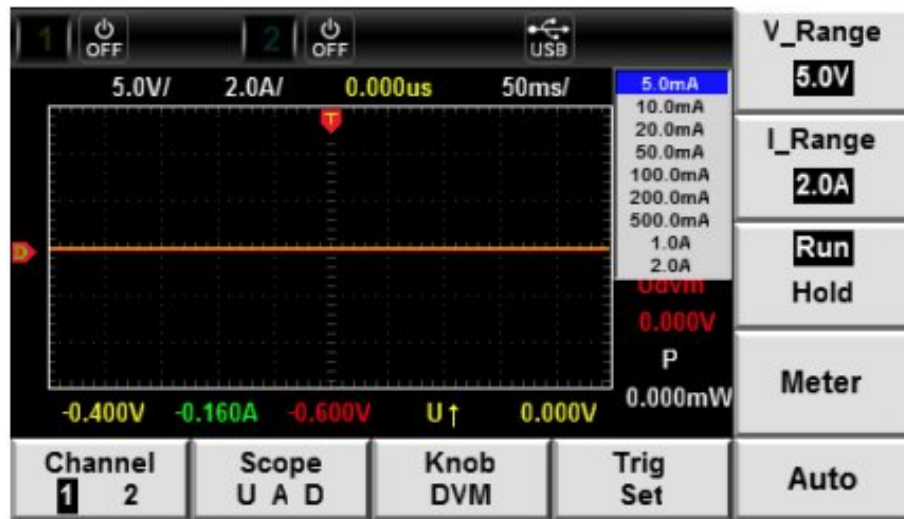

Figure 6.3 I Range

6.8 Run/Hold

To assign a parameter to the rotary knob:

1. Press the **Menu** button then select **Graph** to enter the **Graph Interface**.
2. Press the **F3** softkey to select the **Knob**.
3. Press the corresponding Softkey to select the available parameters.

Press the **F8** softkey to toggle the run or stop status.

Stop

When the trigger status is **Stop** a trigger will take one measurement which will remain on the display until a new trigger is set.

Run

When the trigger status is **Run** measurements will continuously be triggered, and the display will continuously be updated with the latest measure taken.

Battery

The bipolar design along with the variable output impedance, allows the BCS6400 to charge, discharge, and simulate small batteries.



Figure 7.1 Battery Interface

To enter the Battery Interface:

Press the **Menu** button then use the navigation keys or the softkeys to select the  icon.

Setting	Description
Start	Start the selected function
Config	Configure the stop parameters for all the available modes
Capacity Clear	Clear the capacity
Channel	Select the channel terminal
Mode	Select the mode: Charge, Discharge, Simulator
Manual	Configure the parameters for the battery simulation function
Graph	Navigate to the Graph Interface

Table 7.1 Battery Interface

7.1 Start

To start the function selected first configured all the desired parameters, then:

1. Press the **Menu** button then select **Battery** to enter the **Battery Interface**.
2. Press the **F1** softkey to select the **Start**.

7.2 Channel

Toggle between channel 1 and 2 by pressing the **F6** softkey.

Note:

Configuration of any of the battery interface parameters only apply to the selected channel. Toggle between the channels to configure the parameter of the desired channel.

7.3 Mode

The BCS640X series support three modes when the **Battery** interface is selected. This modes include Charge, Discharge, and Simulator.

Charge

The BCS6400 will function as a source outputting up to 45 watts per channel (BCS6401) or 150 watts (BCS6402). Refer to [table 7.2](#) for more information on the output capabilities. The charge function can be ended using the **Shut** configurations: Voltage, Current, Capacity, and Time Shut are available. See [section 7.4](#) for more information.

Model	BCS6401		BCS6402
Channels	2		1
Voltage		CH1	CH2
	High	15 V	0 to 15 V
	Low	9 V	0 to 9 V
Current	High	3 A	
	Low	5 A	
Power	45 W per channel		150 W

Table 7.2 Charge Ranges

Discharge

The BCS6400 will function as a load syncing up to 45 watts per channel (BCS6401) or 150 watts (BCS6402). Refer to [table 7.3](#) for more information on the syncing capabilities. The discharge function can be ended using the **Shut** configurations: Voltage, Current, Capacity, and Time Shut are available. See [section 7.4](#) for more information.

Model	BCS6401		BCS6402
Channels	2		1
Voltage		CH1	CH2
	High	15 V	0 to 15 V
	Low	9 V	0 to 9 V
Current	High	3 A	
	Low	5 A	
Power	45 W per channel		150 W

Table 7.3 Discharge Ranges

Simulation

The BCS640X series supports battery simulation. A battery's profile can be created/edited from the front panel in the **Manual**. Profiles can also be imported from a USB drive. Up to 20 profiles (0 to 19) can be created, with each profile being capable of storing 40 points.

Each point stores the battery's capacity and the voltage and resistance of the battery at said capacity. For more information on creating and editing profiles refer to [section 7.6](#).

Selecting Battery Mode

To select the operation mode:

1. Press the **Menu** button then select **Battery** to enter the **Battery Interface**.
2. Press the **F7** softkey to select **Mode**.



Figure 7.2 Operation Modes

3. Use the navigation keys to navigate the available option.
4. Press the **OK** button to select the highlighted mode.

7.4 Config

The battery configuration menu allows the user to set stop conditions for battery modes. The stop conditions are set separately for each channel, however, the set conditions will carry through all modes in the selected channel.

The following parameters are available:

Voltage Shut(V)

Enable/disable the voltage shut-off point. When enabled once the voltage reaches the stop condition, the operation mode will be stopped.

The voltage shut can be set from 0 to 15.100 V.

The status can be changed by pressing **F7(On)** or **F8(Off)**.

Current Shut(A)

Enable/disable the current shut-off point as well as the battery's max output current in simulator mode. When enabled once the current reaches the stop condition, the operation mode will be stopped.

The current shut can be set from 0 to 5.05 A.

The status can be changed by pressing **F7(On)** or **F8(Off)**.

Capacity Shut(mAH)

Enable/disable the capacity shut-off point. When enabled once the capacity reaches the stop condition, the operation mode will be stopped.

The capacity shut can be set from 0 to 99999.99 mAH.

The status can be changed by pressing **F7(On)** or **F8(Off)**.

Time Shut(s)

Enable/disable the time shut-off point. When enabled once set time elapses the stop condition, the operation mode will be stopped.

The time shut can be set from 0 to 999999 s.

The status can be changed by pressing **F7(On)** or **F8(Off)**.

Full Capacity(mAH)

Set the full capacity value. This parameter is only available when Simulator mode is selected.

The full capacity value can be set from 0 to 99999.99 mAH.

The status can be changed by pressing **F7(On)** or **F8(Off)**.

Once the capacity reaches the stop condition, the battery output will automatically be turned off.

Selecting Battery Config

To configure the stop parameters of the selected mode:

1. Press the **Menu** button then select **Battery** to enter the **Battery Interface**.
2. Press the **F2** softkey to select **Config**. The **Config Menu** will be displayed



Figure 7.3 Config Menu

- **Full Capacity(mAH)** is only available for **Simulation Mode**
3. Select the channel to be configured.
 - Press **F6** to toggle between the channels.
 4. Use the navigation keys to select an available parameter.
 5. Configure the selected parameter using the numeric keypad or the corresponding softkey.

7.5 Capacity Clear

Clear the capacity measurement which will restart the occurring test.

To clear the capacity measurement:

- Press the **Menu** button then select **Battery** to enter the **Battery Interface**.
- Press the **F3** softkey to select the **Capacity Clear**.

7.6 Manual

The BCS6400 can store up to 40 battery **Groups** per channel. Each profile can contain a maximum of 40 **Points**.

Note:

Profiles cannot be shared between channels.

To edit a profile:

1. Press the **Menu** button then select **Battery** to enter the **Battery Interface**.
2. Press the **F8** softkey to enter the **Manual** menu.

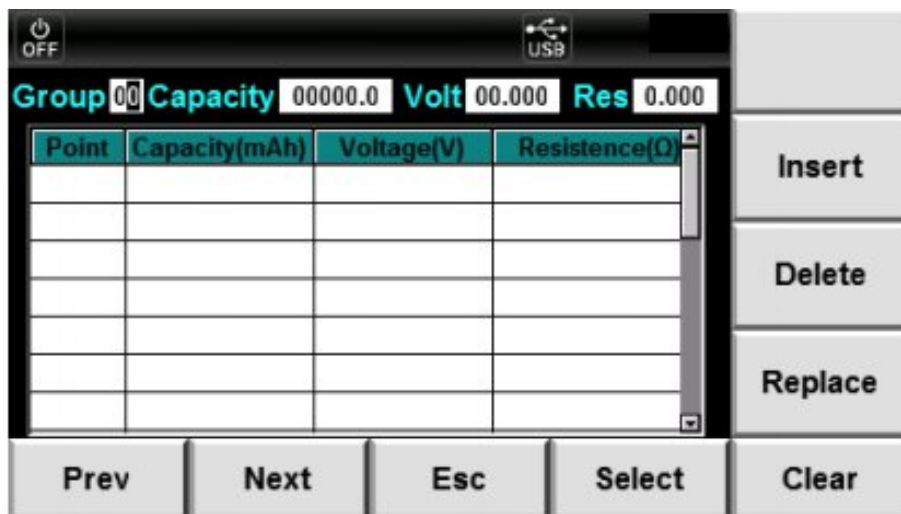

Figure 7.4 Profile

3. Use the softkeys to navigate the available options in the step parameter section.

Channel

Press the **F6** softkey to toggle between channel 1 and channel 2.

Since the profiles are not interchangeable between channels it is important that the correct channel is chosen before the characteristics are set.

Editing Step Parameters

Once in the **Manual** menu use the ▲▼ to navigate the available parameters:

Group Capacity Volt Res

The numeric keypad or the rotary knob along with the ◀▶ keys can be used to edit the values of the selected parameter.

Clear

Press the **5** softkey to clear all points saved in the selected group.

Insert

A default group will contains no points.

To insert a point press the **F7** softkey.

Pressing the **F7** softkey will insert a point below the currently selected point.

The inserted point will have the parameters set in the step parameter section.

Delete

Press **F8** softkey to delete the selected point.

To navigate the points in a group use the softkeys **F1**(Previous) and **F2**(Next).

Replace

Press **F9** to replace the selected point with a point consisting of the parameters set in the step parameter section.

Prev

Press the **F1** softkey to select the point previous to the currently chosen point.

Next

Press the **F2** softkey to select the point following the currently chosen point.

Select

Press the **F4** softkey to load the selected group.

Once the group has been loaded the message **Loading Done!** will be displayed.

Esc

Press the **F3** softkey to exit the **Manual** menu.

List

The BCS6400 is capable of storing up to 20 list per channel in the internal memory. Each list can have up to 30 configurable steps. List memory is not sharable across channels; therefore it is important to select the correct channel before editing a list.

If all 20 available list are already set, an external list can be imported from a USB, allowing for a larger collection of programmed lists.

To enter the **List Interface**:

Press the **Menu** button then use the navigation keys or the softkeys to select the  icon.

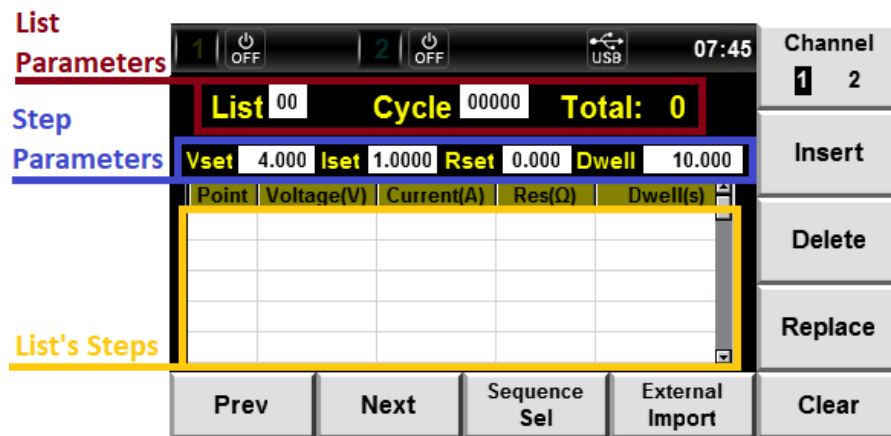

Figure 8.1 List Interface

Setting	Description
List Parameters	View and edit the list parameters.
Step Parameters	View and edit the step parameters.
Channel	Select a channel.
Insert	Insert a step to the selected list.
Delete	Delete the selected step.
Replace	Replace the selected step.
Sequence Sel	Enter the Sequence Select menu.
External Import	Import a list from a USB.
Clear	Clear all steps of selected list.

Table 8.1 List Interface

8.1 List Setup

Upon entering the **List Interface** the last selected list will be displayed.

Channel

Before editing any parameters ensure the correct channel is selected. List memory is not sharable across channels. Therefore if a list is configured in the wrong channel the other channel will not be able to run said list.

Press the **F6** softkey to toggle between channel 1 and 2.

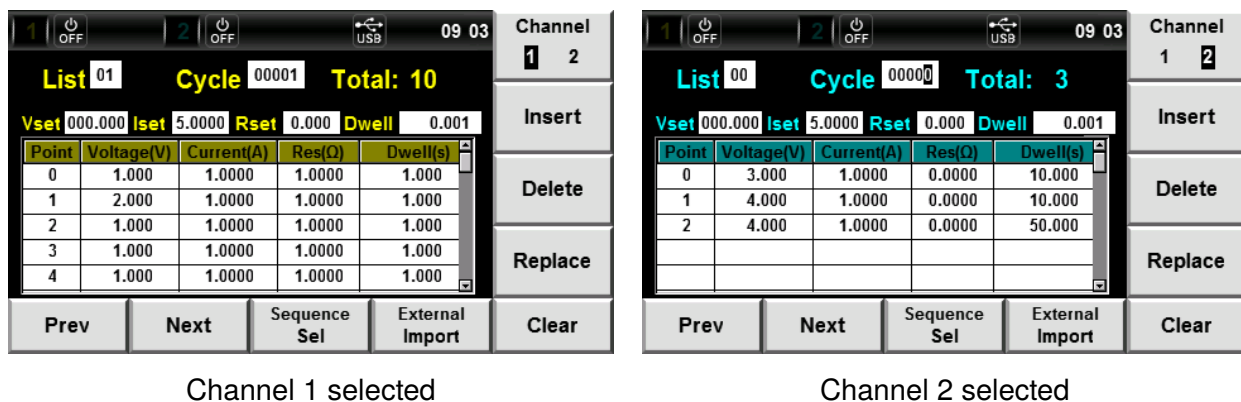

Figure 8.2 Select Channel

8.1.1 List Parameters

After selecting the desired channel the list to be configured must be selected.

- Select the list to be configured. (0 to 19)
 - Use the ▲ ▼ keys to navigate the list and step parameters.
 - Once the list parameter is chosen use the numeric keypad or the rotary knob to set a list.
- Set the cycle time of the list. The list can be cycled up to 65535 times.
 - Use the ▲ ▼ keys to navigate the list and step parameters.
 - Once the cycle parameter is chosen use the numeric keypad or the rotary knob to set a list.

Note:

The **Total** parameter in the List Parameter section cannot be edited. It displays the number of steps in the selected list. To edit the selected list see section **Step Parameters**.

8.2 Edit List

A list can be edited by inserting, deleting, or replacing a selected step. If a new list is desired the **Clear** option can be used to delete all parameters at once.

List Navigation

Use the **F1** and **F2** softkeys to navigate the set steps.

Clear

Press the **F5** softkey to clear all set steps of the selected list.

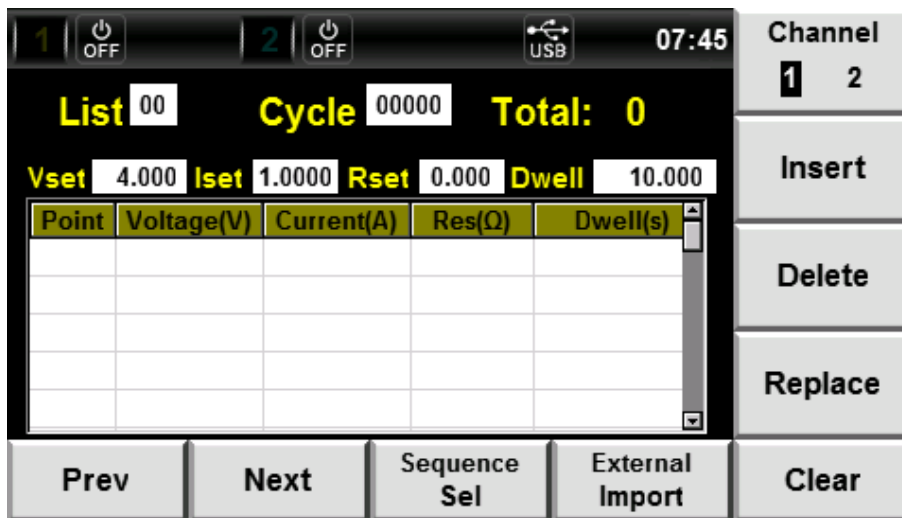

Figure 8.3 List Clear

Insert

Press the **F7** softkey to insert a step. The step will be inserted in the following point. Therefore if the step selected is point 2, the step inserted will be in point 3.

If the list has no step and no position is selected pressing the **F7** softkey will insert a step in position 0. If the list has no steps position 0 is selected pressing the **F7** softkey will display an **Out of Range!** message.

Delete

Press the **F8** softkey to delete the selected step. Deleting a step will set all the following steps one position down.

Replace

Press the **F9** softkey to replace the selected step with a step consisting of the parameters set in the **Step Parameters** sections.

Navigate to the step to be replaced before making changes to the step parameters.

Changes made in the **Step Parameters** sections will not be saved when navigating between channels.

8.2.1 Step Parameters

The voltage, current, resistance, and dwell time of a step can be configured. All parameters of a step must be configured at once. Therefore, once a step has been set it can be deleted or replaced but not edited.



Figure 8.4 Step Parameter Section

To configure the step parameters:

1. Select the parameter to be configure.
 - Use the ▲ ▼ keys to navigate the list and step parameters.
 - Once the step parameter is chosen use the numeric keypad or the rotary knob to set a list.

8.3 Sequence Sel

The saved list can run in a specified sequence. This can be used to chain various list or to expand the cycle time of a previous list that has exceeded the maximum cycled time.

To enter the **Sequence Sel** menu:



Press the **Menu** button then use the navigation keys or the softkeys to select the  icon. Then press the **F3** softkey.



Figure 8.5 Sequence Sel

Press the **F6** softkey to toggle between channel 1 and channel 2.

The   keys are used to navigate the available list of the selected channel.

The selected list can be enabled or disabled in the sequence by pressing the **F7** or **F8** softkey.

List that will run in the sequence will be marked with a **Y** in the **Select** section.

List that will not run in the sequence will be marked with a **N** in the **Select** section.

Example

From figure 8.5 channel 1 would only run list 5 before ending the list mode.

Channel 2 would only run list 1 even though list 0 is marked **Y**. List 0 would not run in the sequence because its cycle time is set to 0. If cycle time for list 0 was set to 1 or greater than triggering list run on channel 2 would cause the output to run through list 0 followed by list 1.

8.3.1 Running a List

List sequence can be initiated in two ways:

ON/OFF



Pressing the **F1** softkey in the Sequence Sel menu will run the sequence of channel 1.

Pressing the **F2** softkey in the Sequence Sel menu will run the sequence of channel 2.

Trigger

The list sequence can be initiated using the  button.

To enable this function:

- Press the **F5** softkey while in the **Sequence Sel** menu to toggle between:
 - **1** enable **Trig Sel** for channel 1. Pressing  will initiate the list sequence programmed in channel 1.
 - **2** enable **Trig Sel** for channel 2. Pressing  will initiate the list sequence programmed in channel 2.
 - **All** enable **Trig Sel** for both channel 1 and 2. Pressing  will initiate the list sequence programmed in both channel 1 and 2.
 - **No selection** disable **Trig Sel**.

8.3.2 External Import

Externally configured list can be loaded into the internal memory using a USB drive. Configuring a list externally facilitates the configuration process as well as allow storage of list outside the limited internal memory of the device.

To create a loadable file:

1. Create a new excel document with the name **ListCHx**
2. Name the first 4 cells of row 1 as shown in figure **8.6**

A	B	C	D
Voltage(V)	Current(A)	Resistance(O)	Delay(S)
1	1	1	1
2	1	1	1
1	1	1	1
1	1	1	1
1	1	1	1
1	1	1	1
1	1	1	1
1	1	1	1
1	1	1	1
1	1	1	1

Figure 8.6 File Format

3. Set the parameters of each step, where the **Step Number= Row Number - 2**.
4. Save the file as a .csv file.
5. Load the file to a USB drive and connect that USB drive to the USB port located in the front panel.
6. Navigate to the List Interface.
7. Select the list number where the saved list will be imported to.
8. Press the **F4** softkey to import the list. The device will automatically identify and save the file to the selected list.

Math

The **Math Interface** allows for configuration of the filter that used to acquire measurements, as well as configuration of the buffer which stores the measured information.

To enter the **Math Interface**:

Press the **Menu** key then use the navigation keys or the softkeys to select the  icon.

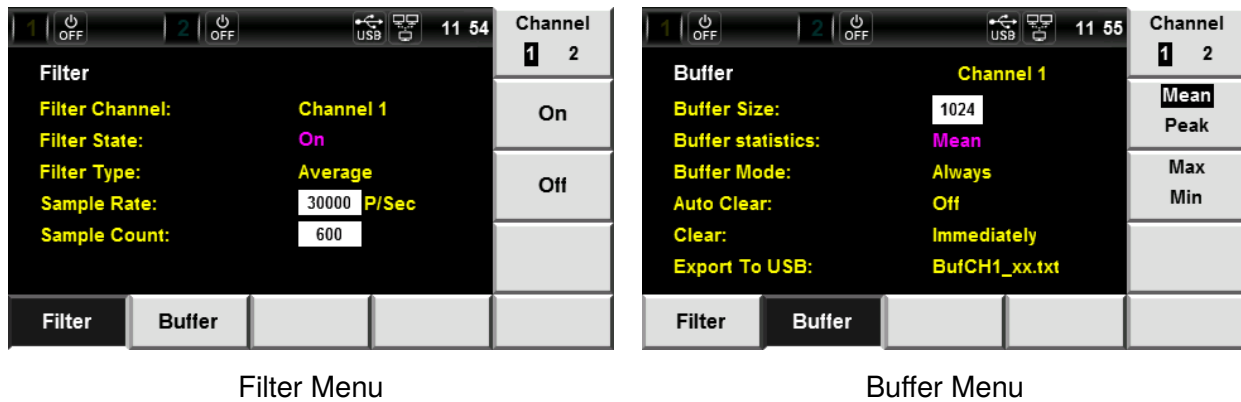

Figure 9.1 Math Interface

Setting	Description
Filter	
Filter Channel	Select the channel to be configure.
Filter State	Enable/disable filtering of measurements.
Filter Type	Set the filter type for data buffer.
Sample Rate	Set the sample rate for the data buffer.
Sample Count	Set the sample count for the data buffer.
Buffer	
Buffer Size	Set the buffer size.(1 to 1,024)
Buffer Statistics	Set the statistic.
Buffer Mode	Set the buffer mode.
Auto Clear	Set the auto clear state.
Clear	Clear the buffer.
Export to USB	Export buffer data to USB as BufCH1_xx.txt file.

Table 9.1 Math Interface

9.1 Filter

The filter is inserted in the voltage and current measurement circuit. The filter influences the measurement of voltage and current.

The influence the filter has on the measurements depends on the type of filter that is selected. For more information read the corresponding section of the filter type.

To enter the **Filter Menu** :

Press the **F1** softkey while in the **Math Interface**.

9.1.1 Filter Channel

Filter settings are not shared between channels. Before configuring any settings the channel to be configured must be selected.

Press the **F6** softkey to toggle between channel 1 and 2.

The text color of the filter settings will set to indicate the selected channel.

9.1.2 Filter State

For the filter setting to be applied the filter must be enabled.

To enable Filter State:

1. In the **Math Interface** use the ▲ ▼ to navigate the available settings.
2. Select the **Filter State**.
 - When selected the parameter will be highlighted in purple.

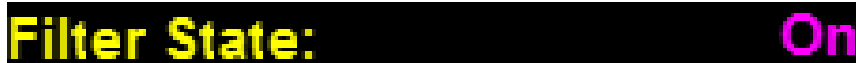

Filter State: On

3. Press the **F7** softkey to enable the filter or press the **F8** softkey to disable the filter.

When the filter is enabled, noise and high-frequency components from the inverter or distortion waveform can be filtered. The cut off frequency of the filter is 40 Hz.

9.1.3 Filter Type

The filter algorithm can be set to: **Average**, **Hanning**, or **Rectangle**.

To set the **Filter Type**:

1. In the **Math Interface** use the ▲ ▼ to navigate the available settings.
2. Select the **Filter Type**.
 - When selected the parameter will be highlighted in purple.



3. Press the corresponding softkey to select the desired filter type.

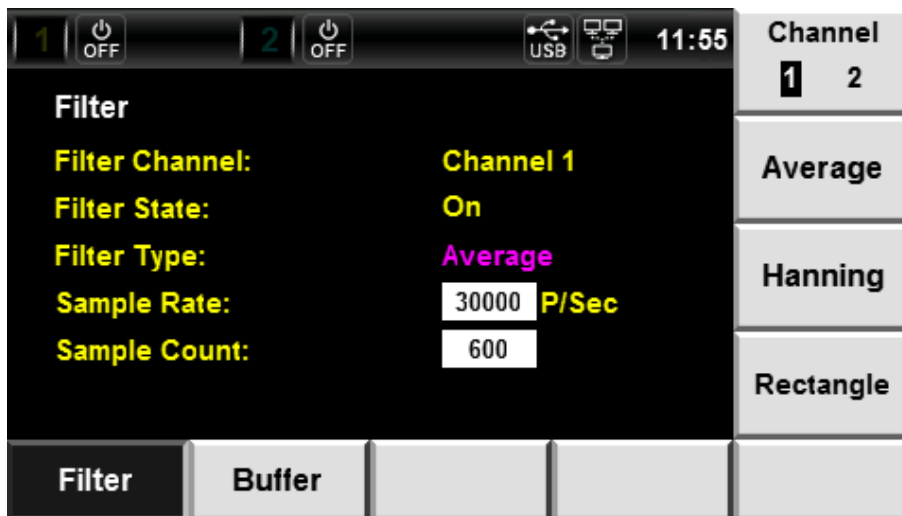

Figure 9.2 Filter Type

Average

The average filter takes an average of the collected measurements. The number of collected measurements can be specified by configuring the **Sample Rate** and the **Sample Count**.

To set the filter type as **Rectangle**:

Press the **F7** softkey when the **Filter Type** setting is selected.

Hanning

The Hanning filter is a low pass filter that is very effective in reducing noise. The filter reaches zero quickly allowing it to filter noise, but also causing it to lose the edges of the signal.

To set the filter type as **Hanning**:

Press the **F8** softkey when the **Filter Type** setting is selected.

Rectangle

The Rectangle filter is a low pass filter that is very effective in reducing noise. The filter reduces noise without losing the edges of the signal.

To set the filter type as **Rectangle**:

Press the **F9** softkey when the **Filter Type** setting is selected.

9.1.4 Sample Rate

The sample rate defines the number of samples per second taken. The sample rate can be configured from 1 to 30000.

To configure the sample rate:

- Enter the **Math Interface** and use the ▲ ▼ to navigate the available settings.
- Select the **Sample Rate** setting.
 - When selected the parameter the least significant digit will be highlighted in a blinking black box.
- Press the corresponding softkey to select the desired filter type.

9.1.5 Sample Count

The sample count defines the total number of samples taken. The sample count can be configured from 50 to 600.

To configure the sample rate:

- Enter the **Math Interface** and use the ▲ ▼ to navigate the available settings.
- Select the **Sample Count** setting.
 - When selected the parameter the least significant digit will be highlighted in a blinking black box.
- Use the numeric keypad or the rotary knob along with the ◀ ▶ to set the value.

9.2 Buffer

The buffer stores the measurement results and data until the max capacity is reached. The collected data can consist of voltages and currents.

When collecting data rapidly it is preferred to store the data in the buffer and exporting the data once the samples have been collected. This alleviates timing limitation that may be occur when rapidly acquiring data through a remote interface.

To enter the **Buffer Menu** :

Press the **F2** softkey while in the **Math Interface**.

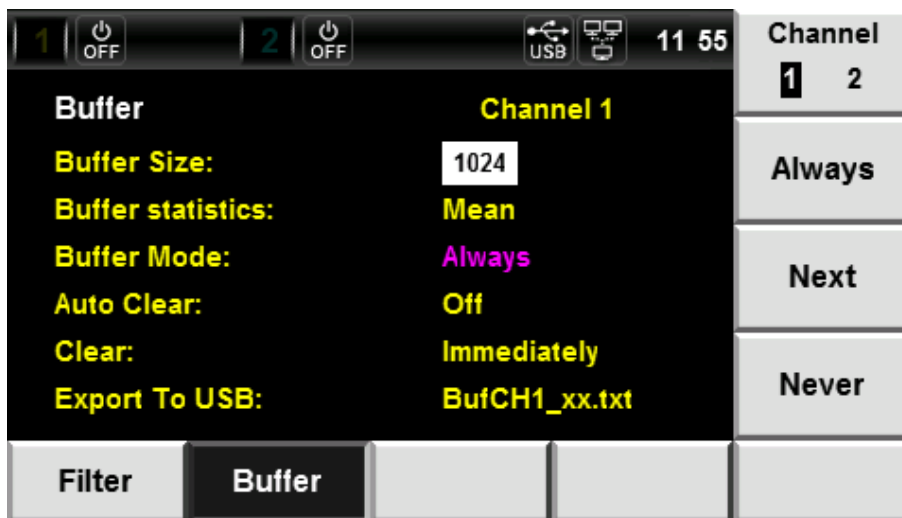

Figure 9.3 Buffer Menu

9.2.1 Buffer Channel

Buffer settings are not shared between channels. Before configuring any settings the channel to be configured must be selected.

Press the **F6** softkey to toggle between channel 1 and 2.

The text color of the filter settings will set to indicate the selected channel.

9.2.2 Buffer Size

The amount of measurements that can be stored in each channel's buffer is limited to 1024.

To set the buffer size:

- Enter the **Math Interface** and use the ▲▼ to navigate the available settings.
- Select the **Buffer Size** setting.
 - When selected the parameter the least significant digit will be highlighted in a blinking black box.
- Use the numeric keypad or the rotary knob along with the ◀▶ to set the value.

9.2.3 Buffer Statistics

The data collected can be configured to save a specified statistic. The sample size collected is raw information from which the unit calculates a measurement.

To set the statistic type the measurement is saved as:

- Enter the **Math Interface** and use the ▲▼ to navigate the available settings.
- Select the **Buffer Statistics** setting.
 - When selected the parameter will be highlighted in purple and the available statistics are displayed.

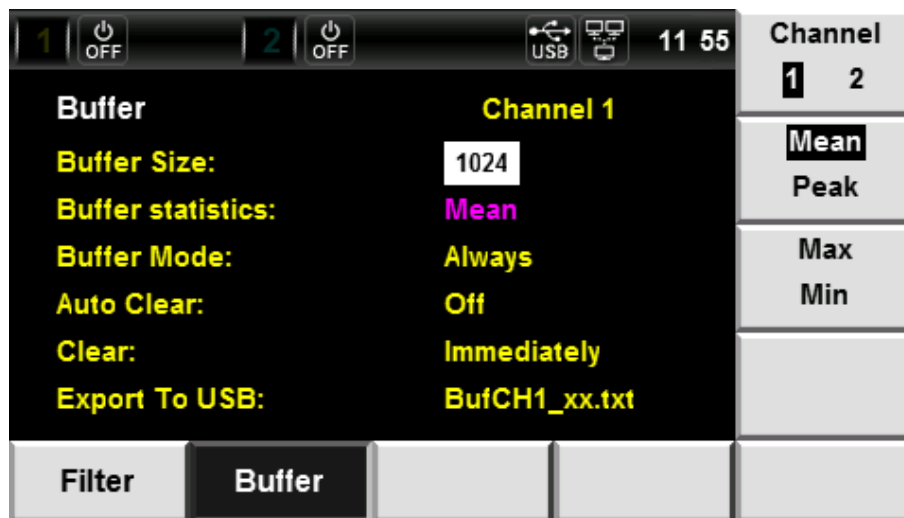

Figure 9.4 Buffer Statistics

- Press the corresponding softkey to select the desired statistic type.

Mean/Peak

Pressing the **F7** softkey to toggle between **Mean** and **Peak**.

- **Mean:** The measurement saved will be the average of all the samples taken.
- **Peak:** The measurement will be saved as a peak value.

Max/Min

Pressing the **F8** softkey to toggle between **Max** and **Min**.

- **Max:** The measurement saved will be the maximum sample recorded.
- **Peak:** The measurement saved will be the minimum sample recorded.

9.2.4 Buffer Mode

Set the save control mode of the selected buffer. In order to store measurements **Trace** must be enabled.

To set the buffer mode:

- Enter the **Math Interface** and use the ▲ ▼ to navigate the available settings.
- Select the **Buffer Mode** setting.
 - When selected the parameter will be highlighted in purple and the available modes are displayed.



Figure 9.5 Buffer Mode

- Press the corresponding softkey to select the desired buffer mode.

Always

Press the **F7** softkey to set the buffer mode as **Always**.

The buffer queue will be set to FIFO (first in first out). The measurements will be stored and read as they occur. When the buffer is full the oldest measurement will be deleted in order to include the newest measurement.

Next

Press the **F8** softkey to set the buffer mode as **Next**.

Write protection will be enabled. Once the buffer is full new measurements will not be written into the buffer.

Never

Press the **F9** softkey to set the buffer mode as **Never**.

Write protection will be disabled. No measurements will be stored in the buffer.

9.2.5 Auto Clear

Set the automatic clear state of the selected buffer.

To set the state of **Auto Clear**:

- Enter the **Math Interface** and use the ▲ ▼ to navigate the available settings.
- Select the **Auto Clear** setting.
 - When selected the parameter will be highlighted in purple and the On Off settings will be displayed.
 - Press the **F7** softkey to enable auto clear.
 - Press the **F8** softkey to disable auto clear.

Note:

Auto Clear will not clear the buffer when **Buffer Mode** is set to next or never.

9.2.6 Clear

Immediately clear all measurements saved in the buffer.

To clear the buffer:

- Enter the **Math Interface** and use the ▲ ▼ to navigate the available settings.
- Select the **Clear** setting.
 - When selected the parameter "**Immediately**" will be highlighted in purple and the **Yes** option will be displayed.
- Press the **F6** softkey to clear the buffer.
 - The message **Clear Successful!** will be display to signify the buffer has been cleared.

Note:

Clear Immediately will clear the buffer regardless of **Buffer Mode** chosen.

9.2.7 Export to USB

The measurements stored in the buffer can be exported to a USB.

The measurements will be stored in a .txt file named "**BufCH1_xx.txt**" or "**BufCH2_xx.txt**" depending on the channel.

To export the buffer's data:

- Enter the **Math Interface** and use the ▲ ▼ to navigate the available settings.
- Select the **Export to USB** setting.
 - When selected the parameter will be highlighted in purple and the **Save** option will be displayed.
- Press the **F6** softkey to export the data.
 - The message **Save Successful!** will be display to signify the data has been exported.

System

The **System Interface** provides information about the device and allows modifications of certain settings.

To enter the **System Interface**: Press the **Menu** button and select the  icon.

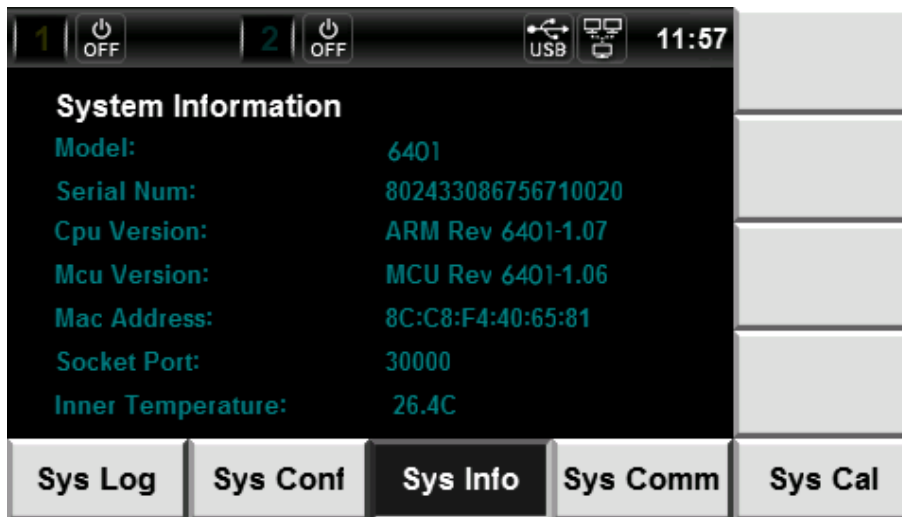

Figure 10.1 System Interface

Settings	Description
Sys Log	
Open	Log all operations.
Close	Stop operation logging.
Sys Conf	
Date	Set the date.
Time	Set the time.
Brightness	Set the display brightness.
Beep	Enable/Disable the key beep.
System Reset	Set the device settings to default.
System SelfTest	Perform a system self-test.
System Protection Clear	Clear all system protections triggered.
Sys Info	
Sys Comm	
Mode	Select the communication interface.
Sys Cal	

Table 10.1 System Interface

10.1 Sys Log

The instrument is capable of recording all operations in a .txt file.

To enable **System Log**:

- Enter the **System Interface**.
- Press the **F1** softkey to enter the **Sys Log** menu.
- Insert a USB drive in the USB port located in the front panel.
 - Journal Log cannot be saved to the internal memory.
 - Please insert USB Device! will be displayed until a USB is inserted.
- Press the **F6** softkey to begin logging.
 - System Journal Open will be displayed the operation recording is in progress.

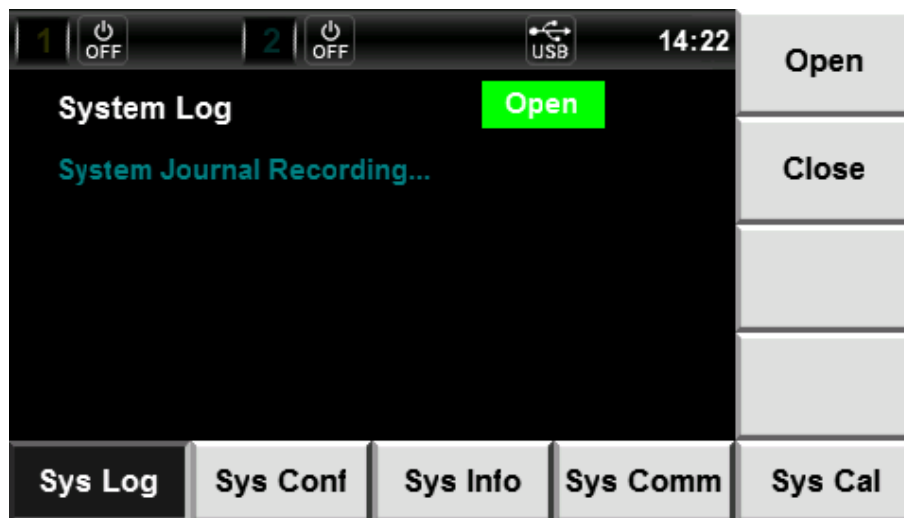

Figure 10.2 System Log Open

- Press the **F7** softkey to stop operation recording.
 - System Journal Closed will be displayed when operation recording is disabled.

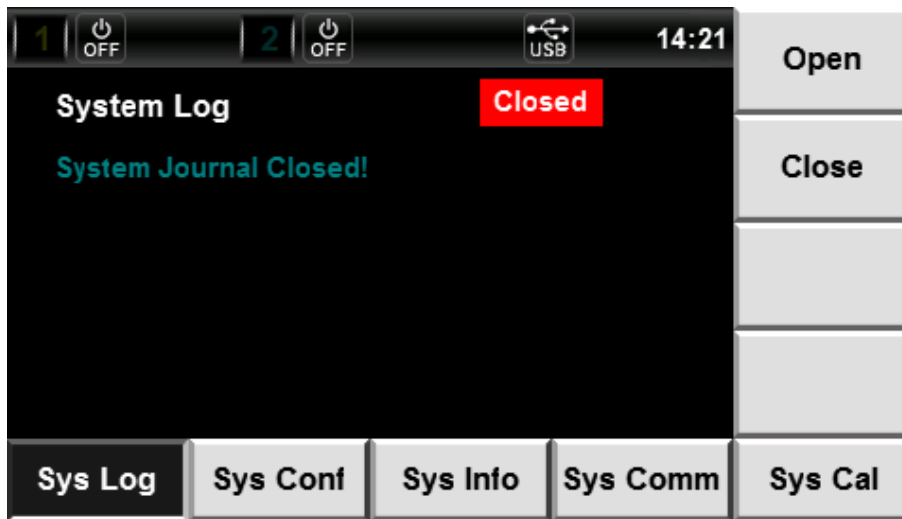

Figure 10.3 System Log Closed

Operations include all output and measurements functions.

File Edit Format View Help

```
Connect Success! PB6400 BK Precision 802433086756710020 Start recording!,210415,15:32:13
:Channel 1 VoltageSet: 2.001,210415,15:32:29
:Channel 1 Graph DVM Base Set: 0.000,210414,11:57:54
:Channel 1 Graph Voltage Trigger Base Set: 0.200,210414,11:57:54
:Channel 1 Graph Voltage Trigger Base Set: 0.000,210414,11:57:54
:Graph Trigger Delay Set: 0.000ms,210414,11:57:54
:Graph Time Div Set:1ms/,210414,11:57:54
:Graph Trigger Delay Set: 0.000ms,210414,11:57:54
:Channel 1 Battery Start,210225,09:07:05
:Channel 1 Battery Stop,210225,09:07:10
```

Figure 10.4 Journal Format

10.2 Sys Conf

To enter the **Sys Conf** menu:

- Enter the **System Interface** then press the **F2** softkey.



Figure 10.5 Sys Conf

10.2.1 Date

To set the **Date**:

- Enter the **System Interface** and use the ▲▼ to navigate the available settings.
 - The year, month, and day are part of the available settings. Use the ▲▼ navigation keys to select each parameter of the date.
- Use the numeric keypad or the rotary knob along with the ◀▶ to configure each parameter.

10.2.2 Time

To set the **Time**:

- Enter the **System Interface** and use the ▲▼ to navigate the available settings.
 - The hour, minutes, and seconds are part of the available settings. Use the ▲▼ navigation keys to select each parameter.
- Use the numeric keypad or the rotary knob along with the ◀▶ to configure each parameter.

10.2.3 Brightness

To set the **Brightness** of the display:

- Enter the **System Interface** and use the ▲ ▼ to navigate the available settings.
- Navigate to the **Brightness** setting.
- The brightness can be set from 1 to 10. {1 = dimmest | 10 = brightest}
 - Use the numeric keypad to enter a brightness level.
 - The rotary knob along with the ◀ ▶ can be used to edit the brightness level .
- Press the **OK** button to set the brightness level.

10.2.4 Beep

To set the **Beep** state:

- Enter the **System Interface** and use the ▲ ▼ to navigate the available settings.
- Navigate to the **Beep** setting.
 - Press the **F6** softkey to enable **Beep**.
 - Press the **F7** softkey to disable **Beep**.

When **Beep** is enabled, the unit will output a beep after pressing any button, softkey, or navigation key.

10.2.5 System Reset

To factory reset all the instruments settings:

- Enter the **System Interface** and use the ▲ ▼ to navigate the available settings.
- Navigate to the **System Reset** setting.
- Press the **F6** softkey to begin the factory reset.
- The device will ask for verification before starting the factory reset.



Figure 10.6 Reset Verification

- Press the **F6** softkey again to begin the factory reset.
 - To cancel the factory settings press the **F7** button.

10.2.6 System Self-Test

The system self-test verifies if there are any issues with the instrument.

To begin a self-test:

- Enter the **System Interface** and use the ▲ ▼ to navigate the available settings.
- Press the **F2 Softkey** to select **Sys Conf**.
- Navigate to the **System Self-Test** settings, then press the **F6** softkey to begin the self-test.
- The device will ask for verification before starting the self-test.

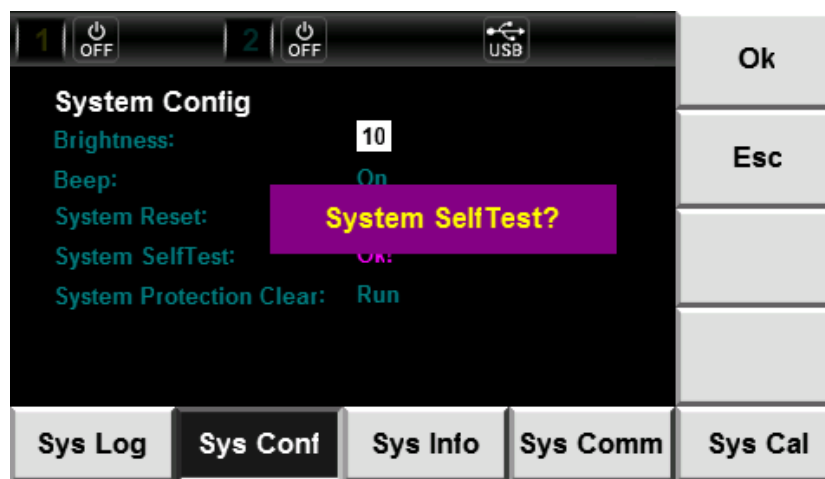

Figure 10.7 Self-Test

- Press the **F6** softkey again to begin the self-test.
 - To cancel the factory settings press the **F7** button.

During the self-test the display cycles through various solid colors.

Once the test is completed the **System Self-Test Done!** message will appear [Figure 10.8](#).

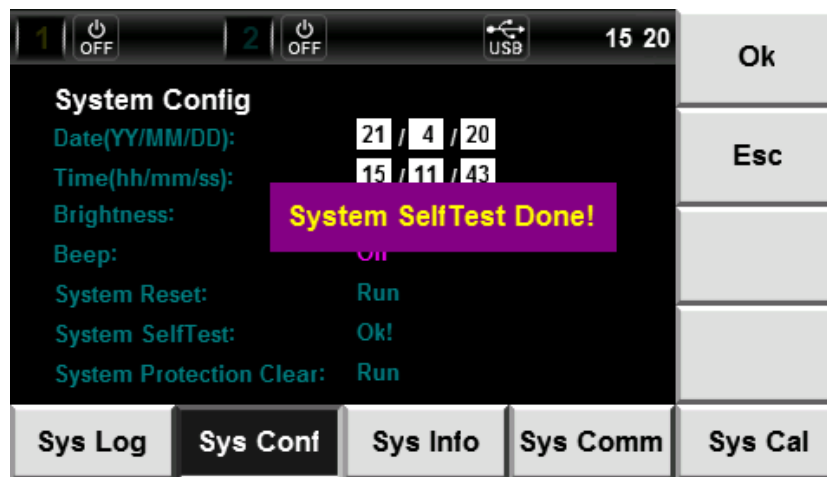

Figure 10.8 Self-Test Done

10.2.7 System Protection Clear

System Protection Clear clears all triggered protection and output latch status. To clear the triggered protections.

- Enter the **System Interface** and use the ▲ ▼ to navigate the available settings.
- Navigate to the **System Self-Test** setting.
- Press the **F6** softkey to clear all triggered protections.
- The device will ask for verification clearing the protection states.

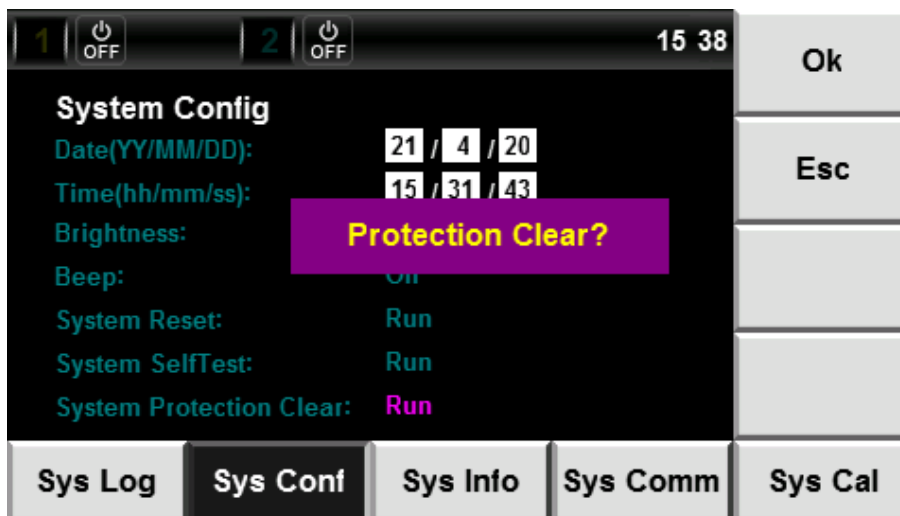

Figure 10.9 Protection Clear

- Press the **F6** softkey again to begin the self-test.
 - To cancel the factory settings press the **F7** button.

10.3 Sys Info

To view the instrument's information:

- Enter the **System Interface**.
- Press the **F3** softkey to enter the **System Information** menu.

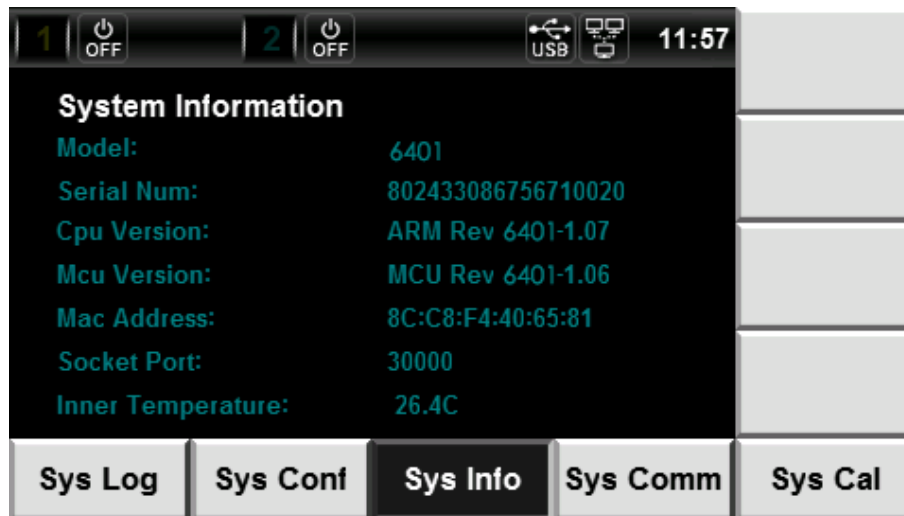

Figure 10.10 Sys Info

10.4 Sys Comm

The following interfaces can be set to remotely control the instrument.

USBTMC LAN

To enter the **Sys Comm** menu:

- Enter the **System Interface**.
- Press the **F4** softkey.

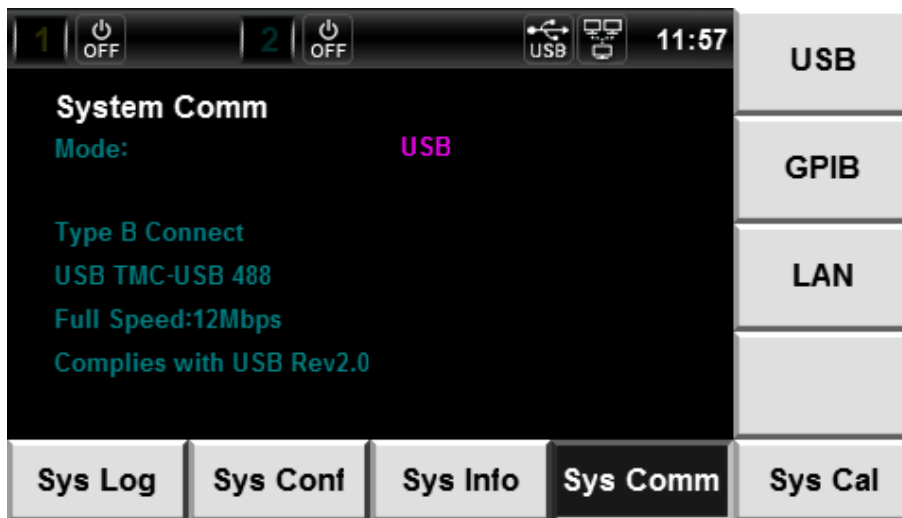

Figure 10.11 System Communication

10.4.1 USBTMC

USBTMC is set as the default interface.

To set the remote interface to USBTMC:

- Enter the **System Interface**.
- Press the **F4** softkey to enter the **System Communication** menu.
- Press the **F6** softkey to select the USB ^{TMC} interface.

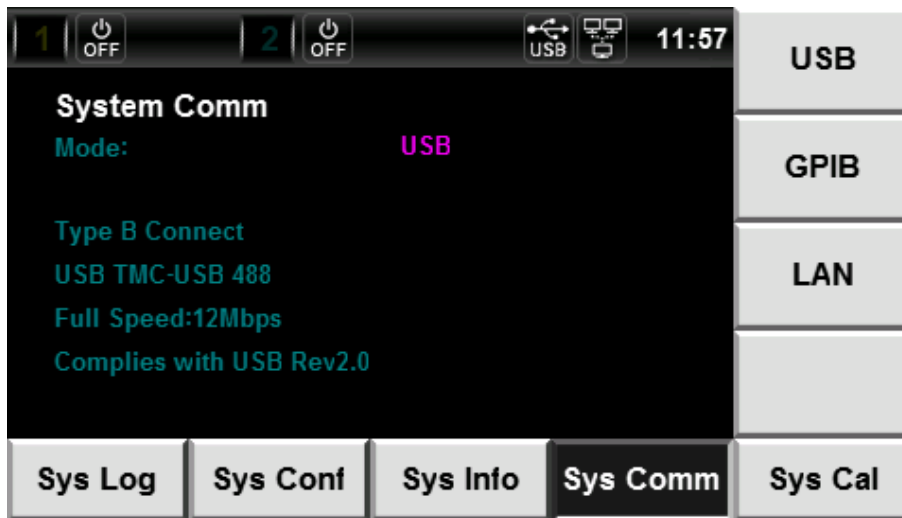

Figure 10.12 USBTMC

Name	<input type="text" value="BK Precision BCS6401"/>
Vendor	BK Precision.Ltd
Model	Model BCS6401
Serial Number	804899015767610001
Status	Present
USB Interface Number	0
488.2 Compliant	<input type="checkbox"/>
VISA Resource Name	USB0::0x3121::0x6001::804899015767610001::INST

Figure 10.13 VISA Resource String

The VISA Resource string gives USB0::<Vendor ID>::<Product ID>::<Serial Number>:INST

Example From figure 10.13
 <Vendor ID> = 0x3121
 <Product ID> = 0x0001 for BCS6400
 <Serial Number> = 802433086756710020

10.4.2 LAN

To set the **LAN Settings**

- Enter the **System Interface**.
- Press the **F4** softkey to enter the **System Communication** menu.
- Press the **F8** softkey to select the LAN interface.

The following settings are available in **LAN Settings**:

- **IP Mode**
- **IP Address**
- **Subnet Mask**
- **Gateway IP**

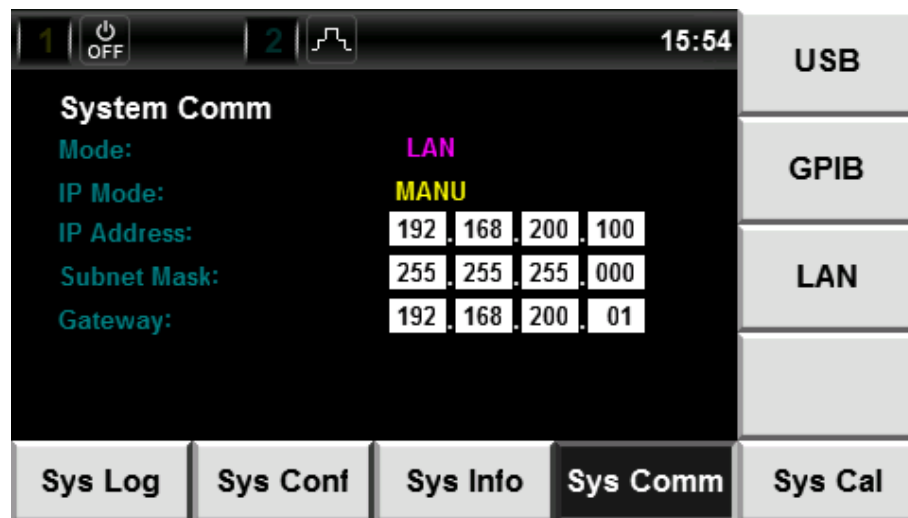

Figure 10.14 LAN Settings

IP Mode

- Enter the **LAN** menu and use the ▲ ▼ to navigate the available settings.
- Navigate to the **IP Mode** setting.
 - Press the **F6** softkey to select **Manual** to set how the LAN settings will be configured.
 - Press the **F7** softkey to select **Dynamic Host Configuration Protocol (DHCP)**

DHCP

The easiest way to configure the LAN settings is to set the IP Mode to **DHCP**. **DHCP** will automatically assign all LAN settings. The LAN settings will not be configurable when **DHCP** is selected.

Manual

Configure the following parameters manually.

IP Address

The **IP Address** is a unique 32 bit string of numbers separated in 4 parts by periods. Each of the 4 parts contains 8 bits and are referred to as octets.

To enter an IP address:

- Enter the **System Interface** and use the ▲ ▼ to navigate the available settings.
- Navigate to the **IP Address** setting.
- Use the numeric keypad to enter the selected portion of the IP address.
- Use the ▲ ▼ keys to navigate each octet.

Subnet Mask

Subnet Mask helps distinguish which part of the IP address is the network address and the host address.

To set **Subnet Mask**:

- Enter the **System Interface** and use the ▲ ▼ to navigate the available settings.
- Navigate to the **Subnet Mask** setting.
- Use the numeric keypad to enter the selected portion of the IP address.
- Use the ▲ ▼ keys to navigate each octet.

Gateway IP

The gateway address is by default the IP address of the network device that connects the instrument. If **IP Mode** is set to DHCP **Gateway IP** does not have to be set.

To set **Gateway IP** :

- Enter the **System Interface** and use the ▲ ▼ to navigate the available settings.
- Navigate to the **Gateway IP** setting.

- Use the numeric keypad to enter the selected portion of the IP address.
- Use the ▲▼ keys to navigate each octet.

10.5 Sys Cal

To enter the **Sys Cal** menu:

- Enter the **System Interface**.
- Press the **F5** softkey.

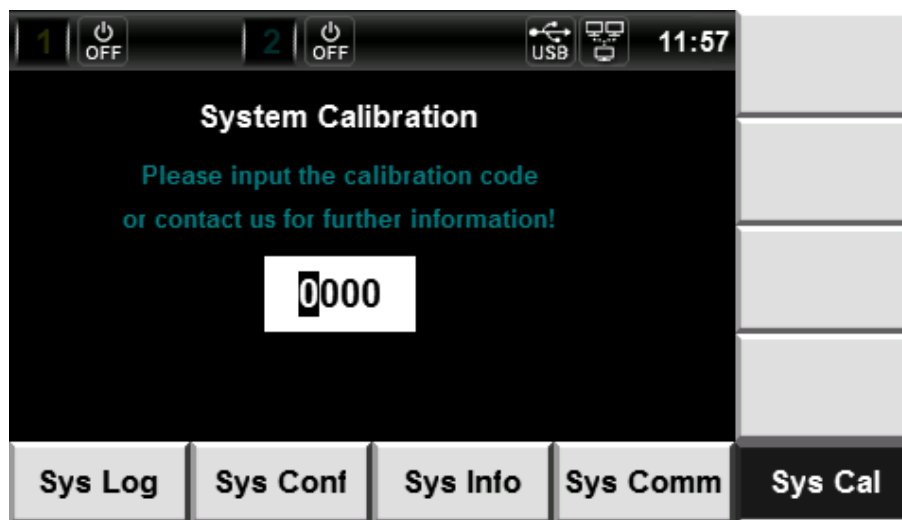

Figure 10.15 System Cal

- Enter the 4 digit password.

Battery Charger/Simulator and DC Power Supply BCS Series

Specifications

Note: All specifications apply to the unit after a temperature stabilization time of 15 minutes over an ambient temperature range of $23\text{ }^{\circ}\text{C} \pm 5\text{ }^{\circ}\text{C}$. Specifications are valid for single unit operation only.

Model	BCS6401		BCS6402
Channels	2		1
Voltage		CH1	CH2
	High	$\pm 15\text{ V}$	0 to 15 V
	Low	$\pm 9\text{ V}$	0 to 9 V
Max Source / Sink Current	High	3 A	
	Low	5 A	
Power	45 W per channel, up to 90 W combined		150 W
Variable Output Impedance	0 to 1 Ω		
Load Regulation \pm (% output + offset)			
Voltage	$\leq 0.01\% + 2\text{ mV}$		
Current	$\leq 0.05\% + 1\text{ mA}$		
Line Regulation \pm (% output + offset)			
Voltage	$\leq 0.02\% + 2\text{ mV}$		
Current	$\leq 0.05\% + 1\text{ mA}$		
Ripple and Noise (20 Hz to 20 MHz)			
Normal Mode Voltage p-p	$\leq 3\text{ mV}$		$\leq 4\text{ mV}$
Normal Mode Voltage rms	$\leq 1\text{ mV}$		
Normal Mode Current rms	$\leq 1\text{ mA}$		
Programming Resolution			
Voltage	1 mV		
Current	0.1 mA		
Variable Output Impedance	1 m Ω		
Readback Resolution			
Voltage	1 mV		
Current	5 A Range	0.1 mA	
	5 mA Range	100 nA	
Programming Accuracy \pm (% output + offset)			
Voltage	$\leq 0.02\% + 3\text{ mV}$		
Current	$\leq 0.05\% + 2\text{ mA}$		$\leq 0.05\% + 3\text{ mA}$
Variable Output Impedance	$\leq 0.1\% + 3\text{ m}\Omega$		
Readback Accuracy \pm (% output + offset)			
Voltage	$\leq 0.02\% + 2\text{ mV}$		$\leq 0.02\% + 3\text{ mV}$
Current	5 A Range	$\leq 0.05\% + 0.2\text{ mA}$	
	5 mA Range ⁽¹⁾	$\leq 0.05\% + 2\text{ }\mu\text{A}$	
Temperature Coefficient \pm (% output + offset) / $^{\circ}\text{C}$			
Voltage	0.005% + 0.2 mV		0.005% + 0.4 mV
Current	0.005% + 0.2 mA		0.01% + 0.2 mA
Resistance	0.02% + 0.5 m Ω		

Specifications (cont.)

Model		BCS6401		BCS6402		
Output Response Time ⁽²⁾						
Rise Time	Voltage	Full load	≤ 500 μs		≤ 150 μs	
		No load	≤ 500 μs		≤ 150 μs	
	Current	Full load	Fast mode	≤ 150 μs	Fast mode	≤ 150 μs
			Normal mode	≤ 10 ms	Normal mode	≤ 10 ms
Fall Time	Voltage	Full Load ⁽³⁾	≤ 150 μs		≤ 50 μs	
		No load	≤ 1 ms		≤ 150 μs ⁽⁴⁾	
Transient Response ⁽⁵⁾						
		Time	≤ 50 μs		≤ 30 μs	
DVM						
Measurement Range		-20 V to +20 V		-30 V to +30 V		
Resolution		1 mV				
Accuracy		0.02% + 3 mV				
General						
Remote Sense Compensation		1 V				
Command Response Time ⁽⁶⁾		5 ms				
Power Factor		0.7 max.				
I/O Interfaces		USB (USBTMC-compliant) and LAN				
AC Line Input		110/220 VAC ± 10%, 47 Hz to 63 Hz				
Isolation (output to ground)		100 VDC max.				
Output Impedance (output off, typical)	Output-off state Normal	150 kΩ		200 kΩ		
	Output-off state Relay off	≥ 1 GΩ ⁽⁷⁾		≥ 1 GΩ		
Protection Functions		OVP/OCP/OTP/Reverse voltage protection		OVP/OCP/OTP		
Maximum Rated Input Power		500 VA				
Temperature Ratings	Operation	32 °F to 104 °F (0 °C to 40 °C)				
	Storage	14 °F to 158 °F (-10 °C to 70 °C)				
Dimensions (W x H x D)		8.9" x 3.5" x 18.75" (226 x 88.2 x 476.26 mm)				
Weight		19.85 lbs (9 kg)		17.64 lbs (8 kg)		
Warranty		3 Years				
Standard Accessories		Power cord & certificate of calibration				
Optional Accessories		Rack mount kit (RK2US)				

Regulatory Compliance	
Safety	Low Voltage Directive (LVD) 2014/35/EU, EN61010-1:2010
Electromagnetic Compatibility	EMC Directive 2014/30/EU, EN61326-1:2013

- (1) The current readback accuracy of the 5 mA range is measured in constant voltage mode.
(2) From 10% to 90% or from 90% to 10% of total power excursion. Using positive output polarity.
(3) Fall time at full load when output is disabled.
(4) The set voltage will change to 0 V when the power supply output is 30 V.
(5) Time for output voltage to recover within 50 mV for a load change 50-100% of full load. Output speed set to Fast.
(6) Typical time required for output to begin to change following receipt of command data.
(7) Relay off function only supported for CHI.

Service Information

Warranty Service: Please go to the support and service section on our website at bkprecision.com to obtain an RMA #. Return the product in the original packaging with proof of purchase to the address below. Clearly state on the RMA the performance problem and return any leads, probes, connectors and accessories that you are using with the device.

Non-Warranty Service: Please go to the support and service section on our website at bkprecision.com to obtain an RMA #. Return the product in the original packaging to the address below. Clearly state on the RMA the performance problem and return any leads, probes, connectors and accessories that you are using with the device. Customers not on an open account must include payment in the form of a money order or credit card. For the most current repair charges please refer to the service and support section on our website.

Return all merchandise to B&K Precision Corp. with prepaid shipping. The flat-rate repair charge for Non-Warranty Service does not include return shipping. Return shipping to locations in North America is included for Warranty Service. For overnight shipments and non-North American shipping fees please contact B&K Precision Corp.

Include with the returned instrument your complete return shipping address, contact name, phone number and description of problem.

B&K Precision Corp.
22820 Savi Ranch Parkway
Yorba Linda, CA 92887
bkprecision.com
714-921-9095

LIMITED THREE-YEAR WARRANTY

B&K Precision Corp. warrants to the original purchaser that its products and the component parts thereof, will be free from defects in workmanship and materials for a period of **three years** from date of purchase. B&K Precision Corp. will, without charge, repair or replace, at its option, defective product or component parts. Returned product must be accompanied by proof of the purchase date in the form of a sales receipt.

To help us better serve you, please complete the warranty registration for your new instrument via our website www.bkprecision.com

Exclusions: This warranty does not apply in the event of misuse or abuse of the product or as a result of unauthorized alterations or repairs. The warranty is void if the serial number is altered, defaced or removed.

B&K Precision Corp. shall not be liable for any consequential damages, including without limitation damages resulting from loss of use. Some states do not allow limitations of incidental or consequential damages. So the above limitation or exclusion may not apply to you.

This warranty gives you specific rights and you may have other rights, which vary from state-to-state.

B&K Precision Corp.
22820 Savi Ranch Parkway
Yorba Linda, CA 92887
www.bkprecision.com
714-921-9095

Version: September 12, 2022