

User Manual

9140 Series

Triple Output Multi-Range DC Power Supplies



Safety Summary

The following safety precautions apply to both operating and maintenance personnel and must be followed during all phases of operation, service, and repair of this instrument.

WARNING

Before applying power to this instrument:

- Read and understand the safety and operational information in this manual.
- Apply all the listed safety precautions.
- Verify that the voltage selector at the line power cord input is set to the correct line voltage. Operating the instrument at an incorrect line voltage will void the warranty.
- Make all connections to the instrument before applying power.
- Do not operate the instrument in ways not specified by this manual or by B&K Precision.

Failure to comply with these precautions or with warnings elsewhere in this manual violates the safety standards of design, manufacture, and intended use of the instrument. B&K Precision assumes no liability for a customer's failure to comply with these requirements.

Category rating

The IEC 61010 standard defines safety category ratings that specify the amount of electrical energy available and the voltage impulses that may occur on electrical conductors associated with these category ratings. The category rating is a Roman numeral of I, II, III, or IV. This rating is also accompanied by a maximum voltage of the circuit to be tested, which defines the voltage impulses expected and required insulation clearances. These categories are:

Category I (CAT I): Measurement instruments whose measurement inputs are not intended to be connected to the mains supply. The voltages in the environment are typically derived from a limited-energy transformer or a battery.

Category II (CAT II): Measurement instruments whose measurement inputs are meant to be connected to the mains supply at a standard wall outlet or similar sources. Example measurement environments are portable tools and household appliances.

Category III (CAT III): Measurement instruments whose measurement inputs are meant to be connected to the mains installation of a building. Examples are measurements inside a building's circuit breaker panel or the wiring of permanently-installed motors.

Category IV (CAT IV): Measurement instruments whose measurement inputs are meant to be connected to the primary power entering a building or other outdoor wiring.

WARNING

Do not use this instrument in an electrical environment with a higher category rating than what is specified in this manual for this instrument.

WARNING

You must ensure that each accessory you use with this instrument has a category rating equal to or higher than the instrument's category rating to maintain the instrument's category rating. Failure to do so will lower the category rating of the measuring system.

Electrical Power

This instrument is intended to be powered from a CATEGORY II mains power environment. The mains power should be 115 V RMS or 230 V RMS. Use only the power cord supplied with the instrument and ensure it is appropriate for your country of use.

Ground the Instrument

WARNING

To minimize shock hazard, the instrument chassis and cabinet must be connected to an electrical safety ground. This instrument is grounded through the ground conductor of the supplied, three-conductor AC line power cable. The power cable must be plugged into an approved three-conductor electrical outlet. The power jack and mating plug of the power cable meet IEC safety standards.

WARNING

Do not alter or defeat the ground connection. Without the safety ground connection, all accessible conductive parts (including control knobs) may provide an electric shock. Failure to use a properly-grounded approved outlet and the recommended three-conductor AC line power cable may result in injury or death.

WARNING

Unless otherwise stated, a ground connection on the instrument's front or rear panel is for a reference of potential only and is not to be used as a safety ground. Do not operate in an explosive or flammable atmosphere.

WARNING

Do not operate the instrument in the presence of flammable gases or vapors, fumes, or finely-divided particulates.

WARNING

The instrument is designed to be used in office-type indoor environments. Do not operate the instrument

- In the presence of noxious, corrosive, or flammable fumes, gases, vapors, chemicals, or finely-divided particulates.
- In relative humidity conditions outside the instrument's specifications.
- In environments where there is a danger of any liquid being spilled on the instrument or where any liquid can condense on the instrument.
- In air temperatures exceeding the specified operating temperatures.
- In atmospheric pressures outside the specified altitude limits or where the surrounding gas is not air.
- In environments with restricted cooling air flow, even if the air temperatures are within specifications.
- In direct sunlight.

This instrument is intended to be used in an indoor pollution degree 2 environment. The operating temperature range is 0°C to 40°C and 20% to 80% relative humidity, with no condensation allowed. Measurements made by this instrument may be outside specifications if the instrument is used in non-office-type environments. Such environments may include rapid temperature or humidity changes, sunlight, vibration and/or mechanical shocks, acoustic noise, electrical noise, strong electric fields, or strong magnetic fields.

Do not operate instrument if damaged

WARNING

If the instrument is damaged, appears to be damaged, or if any liquid, chemical, or other material gets on or inside the instrument, remove the instrument's power cord, remove the instrument from service, label it as not to be operated, and return the instrument to B&K Precision for repair. Notify B&K Precision of the nature of any contamination of the instrument.

Clean the instrument only as instructed

WARNING

Do not clean the instrument, its switches, or its terminals with contact cleaners, abrasives, lubricants, solvents, acids/bases, or other such chemicals. Clean the instrument only with a clean dry lint-free cloth or as instructed in this manual. Not for critical applications

WARNING

This instrument is not authorized for use in contact with the human body or for use as a component in a life-support device or system.

Do not touch live circuits

WARNING

Instrument covers must not be removed by operating personnel. Component replacement and internal adjustments must be made by qualified service-trained maintenance personnel who are aware of the hazards involved when the instrument's covers and shields are removed. Under certain conditions, even with the power cord removed, dangerous voltages may exist when the covers are removed. To avoid injuries, always disconnect the power cord from the instrument, disconnect all other connections (for example, test leads, computer interface cables, etc.), discharge all circuits, and verify there are no hazardous voltages present on any conductors by measurements with a properly-operating voltage-sensing device before touching any internal parts. Verify the voltage-sensing device is working properly before and after making the measurements by testing with known-operating voltage sources and test for both DC and AC voltages. Do not attempt any service or adjustment unless another person capable of rendering first aid and resuscitation is present.

Do not insert any object into an instrument's ventilation openings or other openings.

WARNING

Hazardous voltages may be present in unexpected locations in circuitry being tested when a fault condition in the circuit exists.

WARNING

Fuse replacement must be done by qualified service-trained maintenance personnel who are aware of the instrument's fuse requirements and safe replacement procedures. Disconnect the instrument from the power line before replacing fuses. Replace fuses only with new fuses of the fuse types, voltage ratings, and current ratings specified in this manual or on the back of the instrument. Failure to do so may damage the instrument, lead to a safety hazard, or cause a fire. Failure to use the specified fuses will void the warranty.

Servicing

WARNING

Do not substitute parts that are not approved by B&K Precision or modify this instrument. Return the instrument to B&K Precision for service and repair to ensure that safety and performance features are maintained.

For continued safe use of the instrument

- Do not place heavy objects on the instrument.
- Do not obstruct cooling air flow to the instrument.
- Do not place a hot soldering iron on the instrument.
- Do not pull the instrument with the power cord, connected probe, or connected test lead.
- Do not move the instrument when a probe is connected to a circuit being tested.





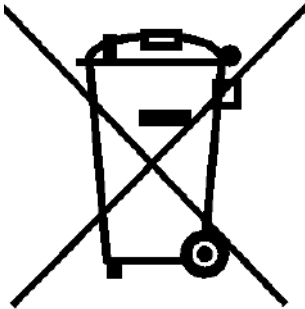





Compliance Statements

Disposal of Old Electrical & Electronic Equipment (Applicable in the European Union and other European countries with separate collection systems)



This product is subject to Directive 2002/96/EC of the European Parliament and the Council of the European Union on waste electrical and electronic equipment (WEEE), and in jurisdictions adopting that Directive, is marked as being put on the market after August 13, 2005, and should not be disposed of as unsorted municipal waste. Please utilize your local WEEE collection facilities in the disposition of this product and otherwise observe all applicable requirements.

Safety Symbols

Symbol	Description
	indicates a hazardous situation which, if not avoided, will result in death or serious injury.
	indicates a hazardous situation which, if not avoided, could result in death or serious injury
	indicates a hazardous situation which, if not avoided, will result in minor or moderate injury
	Refer to the text near the symbol.
	Electric Shock hazard
	Alternating current (AC)
	Chassis ground
	Earth ground
	This is the In position of the power switch when instrument is ON.
	This is the Out position of the power switch when instrument is OFF.
	is used to address practices not related to physical injury.

Contents

1	Introduction	9
1.1	Product Overview	9
1.2	Contents	9
1.3	Features	10
1.4	Dimensions	10
1.5	Rackmount Installation	10
1.6	Front Panel	10
1.7	Display	11
1.8	Rear Panel	11
2	Getting Started	12
2.1	Input Power and Fuse Requirements	12
2.2	Fuse Requirements	12
2.3	Check or Replace Fuse	13
2.4	Output Connections	13
2.5	Preliminary Check	14
2.6	Self test Errors	15
3	Basic Front Panel Operation	16
3.1	Keys	16
3.1.1	Main Keys	16
3.1.2	Soft Keys	16
3.1.3	Numeric Keys	17
3.1.4	Output Control	17
3.2	Display	18
3.3	Check Model and Firmware Version	21
3.4	Setting Voltage and Current	21
4	Output Configuration	22
4.1	Protection Settings	22
4.1.1	Over Voltage Protection (OVP)	22
4.1.2	Over Current Protection (OCP)	22
4.1.3	Over Temperature Protection & Over Temperature Warning (OTP & OTW)	22
4.1.4	Vmax/Vmin	23
4.1.5	Protection Clear	23
4.2	Output Settings	23
4.2.1	Remote Sense	23
4.2.2	Output Timer	24
4.2.3	Voltage Slew	24
4.2.4	Current Slew	24
4.2.5	On/Off Delay	25
4.3	Operating Mode and Coupling	25
4.3.1	Normal Mode	25
4.3.2	Series Mode	27
5	List Mode	38
5.1	List Setup	38
5.2	Edit List	40
5.2.1	Load/Save List	40
5.2.1	List Number	41
5.2.2	Next	41
5.2.3	Repeat	42
5.2.4	Steps	42
5.3	List Run	44

6	Data Logger	46
6.1	Using the Data Logger Function	46
6.2	Parameters	47
6.2.1	Sampling Interval	47
6.2.2	File Path	47
6.2.3	T. Stamp Filename	47
6.2.4	Log Data	48
6.2.5	Status Code	49
6.2.6	Trigger Source	49
6.2.7	Datalog Start/Stop	49
7	Utilities Menu	50
7.1	User Settings	50
7.1.1	Key Lock Output	50
7.1.2	Beep Sound	50
7.1.3	Date	50
7.1.4	Time	51
7.1.5	Screen Intensity	51
7.1.6	Language	51
7.2	Remote Interface	51
7.2.1	USB Settings	52
7.2.2	LAN	53
7.3	GPIB (optional)	58
7.4	Digital I/O	59
7.4.1	Functions	59
7.4.1	Polarity	60
7.4.1	Inhibit Mode	61
7.5	Test/Admin	62
7.5.1	Self Test	62
7.5.2	Security	62
7.6	Error Log	64
7.7	Help	65
7.8	On Screen Help	65
8	Key Lock	66
9	Save/Recall	67
9.1	Save the Output Settings	67
9.2	Recall the Instrument's Settings	68
9.3	Power-On Settings	69
9.4	Screenshot	70
10	Calibration Adjustment Procedure	71
10.1	Voltage Calibration Adjustment	72
10.2	Current Calibration Adjustment	73
10.3	OVP Calibration Adjustment	74
10.4	OCP Calibration Adjustment	75
10.5	RTC Calibration Adjustment	76
11	Performance Verification	77
12	Specifications	80
13	Service Information	81
14	LIMITED THREE-YEAR WARRANTY	82

Introduction

1.1 Product Overview



Figure 1.1 Front View

The 9140 Series triple output multi-range DC power supplies combine industry-leading power density and performance with an extensive set of features in a compact 2U form factor.

Three isolated output channels each produce 100 W of clean power with exceptionally low ripple and noise characteristics. Combine channels to output up to 300 W, distributing the power across all three channels. Multiple outputs paired with advanced list mode programming, data logging, and protection features make these power supplies suitable for a wide range of benchtop or test system applications.

Model	9140	9141
Voltage per Channel	0 to 32 V	0 to 60 V
Current per Channel	0 to 8 A	0 to 4 A
Maximum Output Power per Channel	100 W	
Maximum Combined Output Power	300 W	

Table 1.1 Models

1.2 Contents

Please inspect the instrument mechanically and electrically upon receiving it. Unpack all items from the shipping carton, and check for any obvious signs of physical damage that may have occurred during transportation. Report any damage to the shipping agent immediately. Save the original packing carton for possible future reshipment. Every power supply is shipped with the following contents:

- 1 x 9140 or 9141 Power Supply
- 1 x AC Power Cord
- 1 x Certificate of Calibration
- 1 x Test Report

Note:

Ensure the presence of all the items above. Contact the distributor or B&K Precision if anything is missing.

1.3 Features

- Three independent galvanically isolated, floating output channels providing up to 100 W per channel or 300 W total when combining all three channels
- High power density, compact 2U half-rack form factor
- Multi-ranging operation delivers rated power at more voltage/current combinations
- Combine outputs in parallel or series to increase current or voltage (up to 24 A or 180 V depending on the model)
- Advanced list mode programming with internal storage for up to 10 list mode programs and list sequencing capabilities
- Digital I/O block offers external triggering, voltage fault and remote inhibit capabilities
- Overvoltage (OVP), overcurrent (OCP), overtemperature (OTP), and includes a key-lock function
- NISPOM-compliant sanitization procedure to securely erase and return the instrument to factory settings
- USB (USBTMC-compliant) and LXI compliant LAN interfaces standard, GPIB optional
- LabVIEWTM, IVI-C, and IVI.NET drivers provided

1.4 Dimensions

The 9140 power supply's dimensions are approximately:
213 mm (8.4 in) x 88.2 mm (3.47 in) x 330 mm (13 in) (W x H x D).



Figure 1.2 Dimensions

1.5 Rackmount Installation

The 9140 Series is compatible with the optional 19-inch rackmount kit model RK2US. The RK2US installation instructions can be downloaded from bkprecision.com

1.6 Front Panel

The front panel interface allows for control of the unit.



Item	Description
1	Main Display
2	Keypad
3	Triple Channel Output Terminals
4	Rotary Knob
5	Main function keys
6	USB host port
7	Power button
8	Soft Menu Keys

1.7 Display



Item	Description
OFF	Indicates output is off
CV	Indicates constant voltage mode
CC	Indicates constant current mode
TRCK I+2	Tracking mode enabled
RMT	Indicates remote mode
Lock icon	Keyboard lock enabled
LOG	Indicates data logging is enabled
LAN icon	LAN status indicator

1.8 Rear Panel

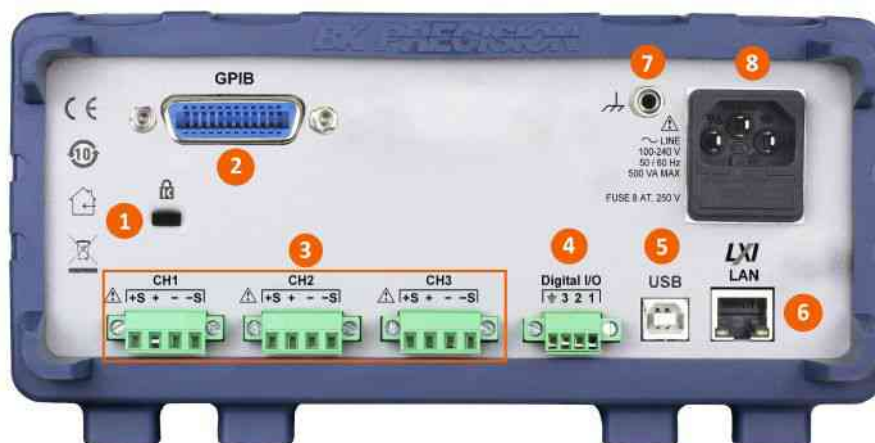

Item	Description
1	Kensington security slot
2	GPIB interface (Optional)
3	Rear output and remote sense terminals
4	Digital I/O terminal block
5	USB interface
6	LAN interface
7	Chassis ground
8	AC power input & fuse box

Getting Started

Before connecting and powering up the instrument, please review and go through the instructions in this chapter.

2.1 Input Power and Fuse Requirements

The supply has a universal AC input that accepts line voltage input within:

Voltage: **100 - 240 VAC (+/- 10 %)**

Frequency: **50/60 Hz**

Input Power: **500 VA MAX.**

Before connecting to an AC outlet or external power source, be sure that the power switch is in the OFF position and verify that the AC power cord, including the extension line, is compatible with the rated voltage/current and that there is sufficient circuit capacity for the power supply. Once verified, connect the cable firmly.

WARNING

The included AC power cord is safety certified for this instrument operating in rated range. To change a cable or add an extension cable, be sure that it can meet the required power ratings for this instrument. Any misuse with wrong or unsafe cables will void the warranty.



SHOCK HAZARD:

The power cord provides a chassis ground through a third conductor. Verify that your power outlet is of the three-conductor type with the correct pin connected to earth ground.

2.2 Fuse Requirements

An AC input fuse is necessary when powering the instrument. The below table shows the fuse required for all models.

Model	Fuse Specification
9140	8 A, 250 V
9141	8 A, 250 V

2.3 Check or Replace Fuse

⚠ WARNING

For safety, no power should be applied to the instrument while changing line voltage operation. Disconnect all cables connected to the instrument before proceeding.

Check and/or Change Fuse

- Locate the fuse box next to the AC input connector in the rear panel. See [1.8](#)
- With a small flat blade screwdriver, insert into the fuse box slit to pull and slide out the fuse box as indicated below.
- Check and replace fuse if necessary (see figure [2.1](#)).

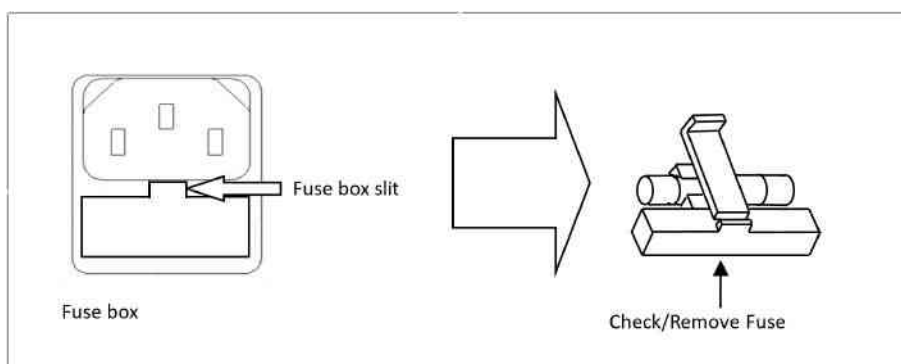

Figure 2.1 Fuse Removal

⚠ WARNING

Any disassembling of the case or changing the fuse not performed by an authorized service technician will void the warranty of the instrument.

2.4 Output Connections

The main DC output terminals are in the front and rear panel of the power supply. The front panel has individual isolated binding post terminals that can also accept sheathed banana jack connectors. The rear panel has terminal block pins for each channel's main output.

⚠ WARNING

Before connecting wires to the output terminals, turn OFF the power supply to avoid damage to the instrument and the device under test (DUT). For safety, load wires must have a wire gauge size large enough to prevent overheating when the power supply operates at maximum short circuit output current. It will also prevent large voltage drops from resistances in the wires.

**SHOCK HAZARD:**

Hazardous voltages may exist at the outputs and the load connections when using a power supply with a rated output greater than 60 V. To protect personnel against accidental contact with hazardous voltages, ensure that the load and its connections have no accessible live parts. Ensure that the load wiring insulation rating is greater than to the maximum output voltage of the power supply.

The rear output terminals can accept wire sizes AWG 24 to AWG 12 (See Table 2). However, we recommend using 12 AWG if current output is between 5 to 10 A. Refer to Table 2 below to determine the proper wire size.

AWG	10	12	14	16	18	20	22	24	26	28
I_{max}(A)	40	25	20	13	10	7	5	3.5	2.5	1.7
mΩ/meter	3.3	5.2	8.3	13.2	21	33.5	52.8	84.3	133.9	212.9

Figure 2.2 Wire Gauge Rating

Output Isolation

The output terminals of the 9140 Series are isolated from earth ground. An earth ground terminal is provided on the front panel for convenience. Any output terminal may be grounded. However, output terminals must not exceed ± 200 VDC.

**SHOCK HAZARD**

Floating voltage must not exceed 200 VDC.

2.5 Preliminary Check

Complete the following steps to verify the Power supply is ready for use.

1. Verify AC Input Voltage

Verify and check to make sure proper AC voltages are available to power the instrument. The AC voltage range must meet the acceptable specification as explained in “2.1 Input Power and Fuse Requirements”.

2. Connect Power & Self-Test

Connect AC power cord to the AC receptacle in the rear panel and press the power button. It will run through a self-test procedure initially before booting to the main screen.

After Power on, during the self-test, the following should be displayed:



Figure 2.3 Scan System

After the system scan is complete the LCD will display as shown in Figure

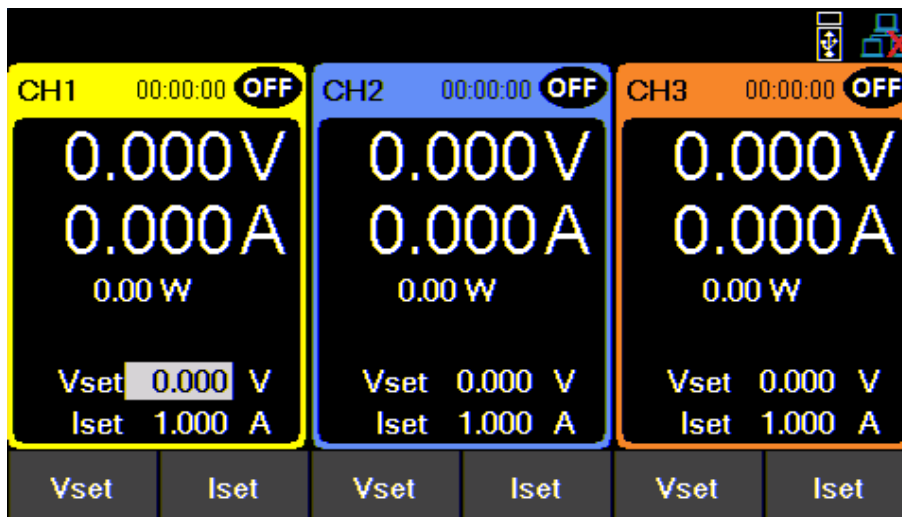

Figure 2.4 Scan complete

Note:

The initial power on state is based on the settings in **Power-ON**

2.6 Self test Errors

The following errors will be displayed if the self-test did not complete successfully:

Error Message on Display	Description
EEPROM Fail	The internal EEPROM is corrupted or damaged.
System Lost	Last system settings within the EEPROM are lost.
Module Fail	Channel response failure.
Cal Lost	Calibration data within the EEPROM is lost.
Fact Loss	Factory calibration data is lost.
Model Lost	Channel initialization failed.

If any of these errors occur, please contact B&K Precision.

Basic Front Panel Operation

At power-on, the power supply will automatically enter the front-panel operation mode and the instrument can be controlled via the front panel keys and knob.

3.1 Keys

3.1.1 Main Keys

There are three main keys:



Navigates the 5 available screens. When navigating any menu returns the key will return "Home" main display.



Opens up a menu giving access to various save and load options, regardless of the current display of the screen.



Opens the main menu bar. If a menu bar is already open, pressing  will navigate to the main menu bar.

5 available displays:

- **Main page:**
Overview of the 3 outputs.
- **Single Channel Display 1 to 3:**
Detailed channel overview.
- **Live Output Monitoring:**
Oscilloscope like overview of the measured output parameters.

More information on each display in [3.2](#).

3.1.2 Soft Keys

The unit has six soft keys, which are located beneath the screen. Each key selects the corresponding function. Functions will vary depending on the current menu or display.



Figure 3.1 Soft Keys

3.1.3 Numeric Keys

The numeric keys allow the configuration of various parameters. Using the numeric keys provides a fast and precise input. The **Enter** key can be found with the numeric keys. Pressing enter will assign the selected value to the desired parameter.



Figure 3.2 Numeric Keys



3.1.4 Output Control

The **ON** button toggles the output On/Off. When output is enabled, the ON button will turn green **ON** and the supply will display the state of the channel.

CC represents constant current mode. **CV** represents constant voltage mode. This is indicated for each channel independently. When output is disabled, the channel state will display **OFF**.

The **All CH On/Off** key toggles all the channels On/Off simultaneously. Its function may vary depending on the coupling state of the channels. For more information go to [Coupling](#).

3.2 Display

These power supplies have three main display modes: three channel display, single channel display, and live output monitoring display. Press the   button to cycle between the different display modes or to return home when viewing any other menu.

Three Channel Display

Provides information of the outputs':

- State
- Run time
- Voltage
- Current
- Power

Allows configuration of:

- Vset
- Iset

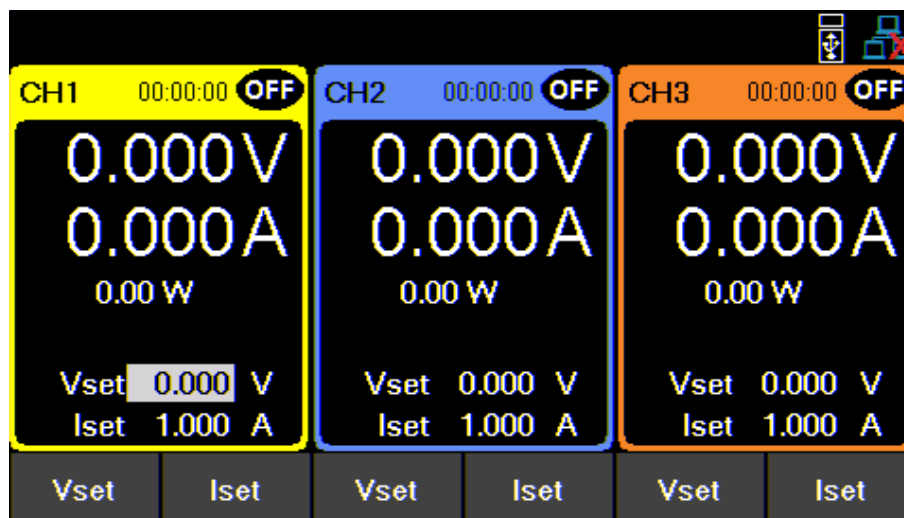

Figure 3.3 Three Channel Display

Single Channel Display

Provides information of the outputs':

- State
- Run time
- Voltage
- Current
- Power
- Vmax/Vmin
- OVP/OCP
- OnDelay/OffDelay

Allows configuration of:

- Vset
- Iset
- Vmax/Vmin
- OVP/OCP
- OnDelay/OffDelay



Figure 3.4 Single Channel Display

Live Output Monitoring

The live output monitoring display shows metered output voltage and current over time. It is always active and will continuously plot and overwrite the oldest value when the display graph is full.

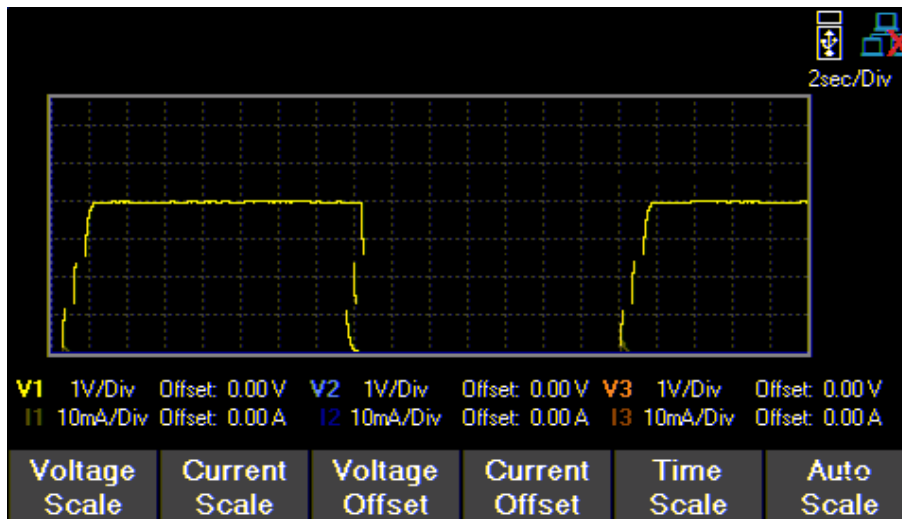

Figure 3.5 Live Output Monitoring Display

The Live output display can be configured by setting the: Voltage, Current, and Time Scale.

Voltage Scale

The voltage scale of each output can be set from 10 mV/Div up to 20 V/Div.

1. While in **Live Output Display** use the softkeys to select **Voltage Scale**.
2. Select a channel to configure.
3. Use the rotary knob to navigate through the available scales.

Current Scale

The current scale of each output can be set from 10 mA/Div up to 3 A/Div.

1. While in **Live Output Display** use the softkeys to select **Current Scale**.
2. Select a channel to configure.
3. Use the rotary knob to navigate through the available scales.

Time Scale

The time scale of each output can be set from 1 s/Div up to 10 min/Div.

1. While in **Live Output Display** use the softkeys to select **Time Scale**.
2. Use the rotary knob to navigate through the available scales.

Voltage Offset

A voltage offset can be added to each output. The offset can be set from 0 V up to 60.6 V on the 9141 and 0 V up to 32.2 V on the 9140.

1. While in **Live Output Display** use the softkeys to select **Voltage Offset**.
2. Select a channel to configure.
3. Use the rotary knob to navigate through the available scales.

Current Offset

A current offset can be added to each output. The offset can be set from 0 A up to 4.4 A on the 9141 and 0 A up to 8.8 A on the 9140.



1. While in **Live Output Display** use the softkeys to select **Current Offset**.
2. Select a channel to configure.
3. Use the rotary knob to navigate through the available scales.

3.3 Check Model and Firmware Version

The firmware version, model, and serial number can be verified by entering the security settings. Press  button then use the soft keys to select Utilities > Help > System Info to view model and firmware information.

3.4 Setting Voltage and Current

Follow the steps below to set the output voltage or current. The values can be entered using the numeric keypad or the rotary knob.

1. Using the keypad: Use the soft keys to select the channel VSET or ISET settings beneath channel view on the display. Then use the numeric keypad to input the voltage or current value then press  to confirm.
2. Using the rotary knob: Use the soft keys to select the channel VSET or ISET settings beneath the channel view on display. Then turn the knob clockwise to increment or counter-clockwise to decrement the value. Use the   below the rotary knob to move the cursor. Press the knob in to confirm.

Output Configuration

4.1 Protection Settings

4.1.1 Over Voltage Protection (OVP)

Over voltage protection is always enabled, however the user can set the OVP voltage limits.

1. Press the  button then use the soft keys to select **Output config** >
Protection settings
2. Use the soft keys to select a channel to adjust.
3. Select **OVP Limit**.
4. Use the numeric keypad or rotary knob to set the desired OVP limit.

When OVP protection is tripped during operation, the output will be de-rated to 0 V and the icon  will appear between the wattage and Vset.

4.1.2 Over Current Protection (OCP)

Over current protection state and limit can be set in the protection settings.

1. Press the  button then use the soft keys to select **Output config** >
Protection settings
2. Use the soft keys to select a channel to adjust.
3. Press **OCP State** to toggle the over current protection on or off.
4. Select **OCP Limit** and use the numeric keypad or rotary knob to set limit value.

When OCP protection is tripped during operation, the output will be de-rated to 0 V and the icon  will appear between the wattage and Vset.

4.1.3 Over Temperature Protection & Over Temperature Warning (OTP & OTW)

The state and limit of both OTP & OTW cannot be set or configured in the protection settings. OTP is set to 85 °C and OTW is set to 75 °C. If the temperature reaches either OTW, the OT icon will blink on the display with a low period beep sound. If temperature reaches OTP the OT icon will show on the display and the output will turn off. The output will not be allowed to turn on until the temperature drops to 75 °C.

Fan Speed Control	
2 A	0%
2 to 5 A	25%
5 A	100%

Figure 4.1 Fan Control

4.1.4 Vmax/Vmin

Configure the maximum or minimum voltage value the user can set from the protection settings.

1. Press the **Utility** button then use the soft keys to select **Output config** > **Protection settings**
2. Use the soft keys to select a channel to adjust.
3. Select **Vmax** or **Vmin** and set a maximum or minimum value using the numeric keypad or rotary knob.

4.1.5 Protection Clear

Protections are cleared from the output configuration settings as shown in the following steps.

1. Press the **Utility** button then use the soft key to select **Output config** > **Protection Clear**.
2. Press the soft key to clear the protection for the corresponding channel, or select **All CH Clear** to clear protections on all three channels.

4.2 Output Settings

4.2.1 Remote Sense

Remote sense can be used to compensate for voltage drops (up to 1 V) due to resistance from test leads connected to your device under test (DUT), thus providing more accurate output voltage. When remote sense is enabled, the positive (+S) and positive lead (+) of the DC output are connected to the positive (+) of the load. Similarly, the negative sense (-S) and negative lead (-) of the DC output are connected to the negative (-) end of the load shown in figure 4.2

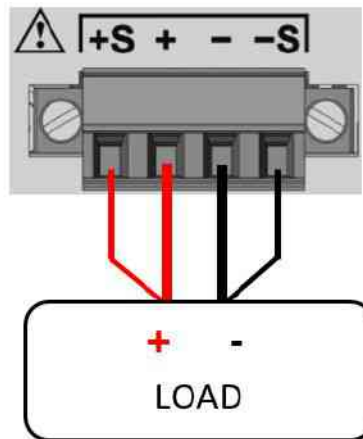

Figure 4.2 Remote Sense

WARNING

Never connect any power source into any of the terminals at any time during operation.

When output is enabled, DO NOT use your hands to touch the terminals or the screws that are designed to tighten wires to the terminals. Doing so may create a shock hazard under high voltage output conditions.

CAUTION

DO NOT at any time disconnect the wires from the S+ and S- terminals to the DUT while output is enabled (ON). Doing so may damage the power supply and cause unstable output.

Remote sense is disabled by default, see the following steps to enable remote sense:

1. Press the  button then use the soft key to select **Output config > Output Settings**.
2. Select a desired channel to configure.
3. Press **Remote Sense** using the soft key to enable remote sense.

4.2.2 Output Timer



Output timer can be set for each channel individually. When the output timer is enabled, an hourglass icon will be displayed next to the channel number. The timer countdown will begin when the channel output is enabled. The output is disabled when the countdown reaches 0. The timer can be set from 1 second to 99 hours 59 minutes and 59 seconds. Follow the steps below to enable and set the output timer:

1. Press the  button then use the soft key to select **Output config > Output Settings**.
2. Select a desired channel to configure. Push Timer State to enable the timer.
3. Select Timer Setting and set a desired time for the output to be enabled using the numeric keypad or rotary knob. The timer format is: HH:MM:SS. Use the keys to move the cursor.



4.2.3 Voltage Slew

The rising voltage slew rate can be set in volts per second. The voltage slew range can be set from 0.001 V/s to 3200.0 V/s.

1. Press the  button then use the soft key to select **Output config > Output Settings**.
2. Select a desired channel to configure.
3. Select Voltage Slew and use the numeric keypad or rotary knob to adjust the slew rate value. Press to confirm input.

4.2.4 Current Slew

The rising current slew rate can be set in amps per second. The current slew range can be set from 1 A/s to 800 A/s.

1. Press the  button then use the soft key to select **Output config > Output Settings**.
2. Select a desired channel to configure.
3. Select **Next Pg. > Current Slew** and use the numeric keypad or rotary knob to adjust the slew rate value. Press  to confirm input.

4.2.5 On/Off Delay

A channel on or off delay in seconds can be applied to any channel. These delays can be set from 0.001 s to 3600.0 s.

1. Press the **Utility** button then use the soft key to select **Output config > Output Settings**.
2. Select a desired channel to configure.
3. Select Next Pg. > On Delay to set an on delay or Off Delay to set an off delay.
4. Use the numeric keypad or rotary knob to adjust the delay value. Press **Enter** to confirm input.

4.3 Operating Mode and Coupling

Set the operation mode or coupling.

Press the **Utility** button then use the soft key to select **Output Config > Op. Mode/Coupling > Operation Mode**.

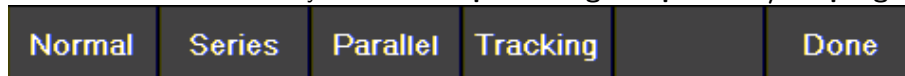

4.3.1 Normal Mode

Sets operation mode to **Normal**.

Normal mode sets the instrument to operate as a true triple output power supply.

Press the **Utility** button then use the soft key to select **Output Config > Op. Mode/Coupling > Operation Mode > Normal**.

9140	9141
Individual CH	Individual CH
32 V 8 A	60 V 4 A

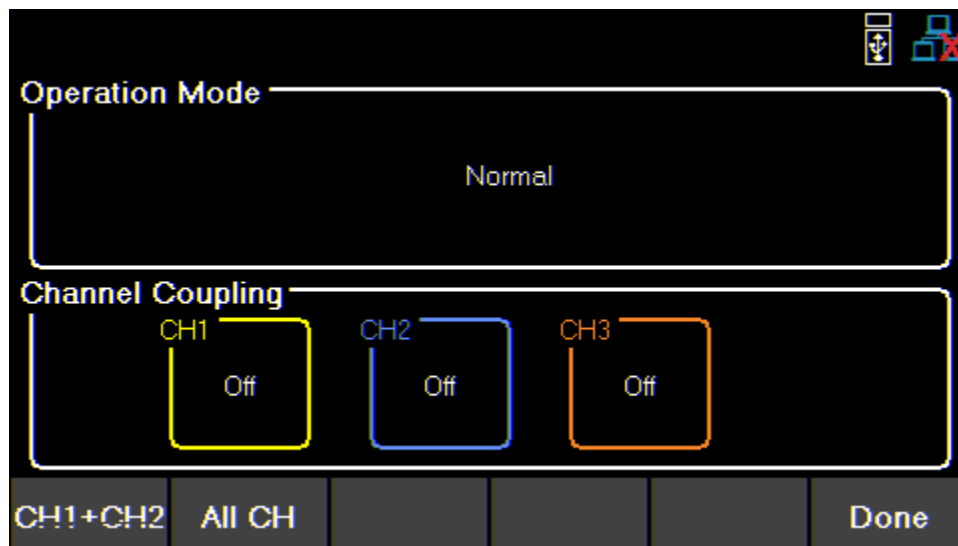

Figure 4.3 Normal Mode

In **Normal mode** the main page will display the three outputs.

Home
Display

Toggles through CH1, CH2, CH3, and live output monitoring display.



Figure 4.4 Normal Mode Main Page

Single CH displays more information about the output, and allows configuration of more parameters.



Figure 4.5 Single Channel

4.3.2 Series Mode

Set operation mode to **Series**.

Series mode changes the UI to accurately represent the possible outputs configurations.

Series mode does not internally wire the outputs. The outputs must be connected externally to increase the available voltage range.

Press the **Utility** button then use the soft key to select **Output Config > Op. Mode/Coupling > Operation Mode > Series**.



The image below illustrates the external wiring required to connect all channels in series. If CH1+ CH2 is chosen CH2's positive terminal does not connect to CH3's negative terminal.

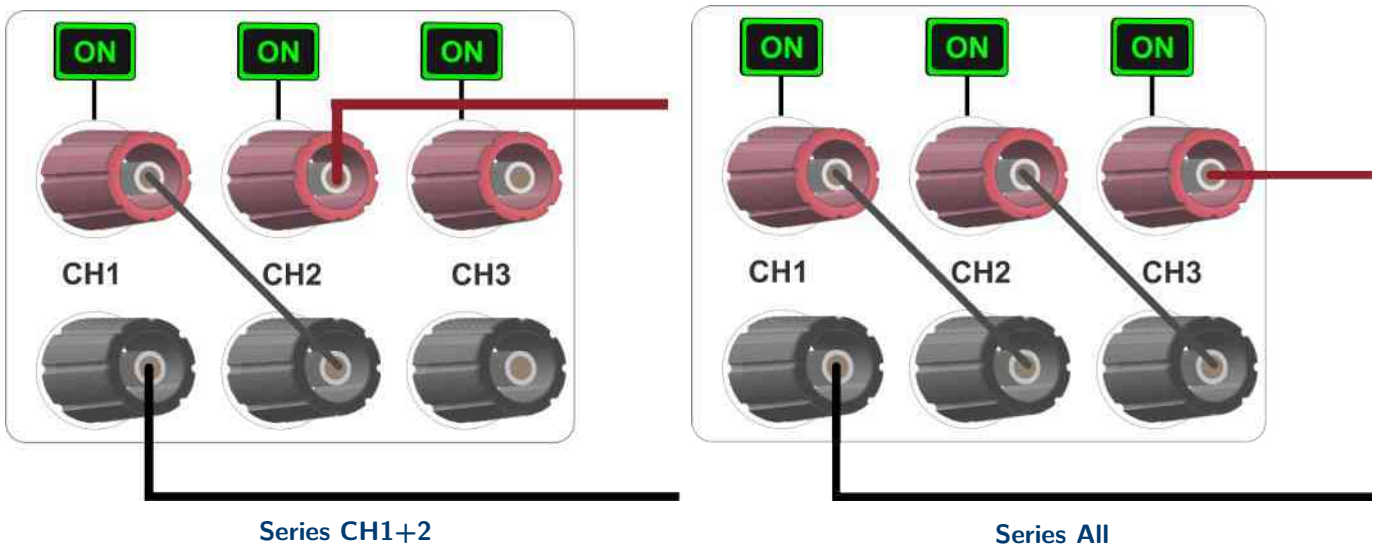

9140		9141	
CH1 + CH2	All CHs	CH1 + CH2	All CHs
64 V	96 V	120 V	180 V

Table 4.1 Series Mode

CH1 + CH2

Operation mode will be set to **Series 1 + 2**. Changing operation mode will undo previous coupling configuration.

Press the **Utility** button then use the soft key to select **Output Config > Op. Mode/Coupling > Operation Mode > Series > CH1 + CH2**.

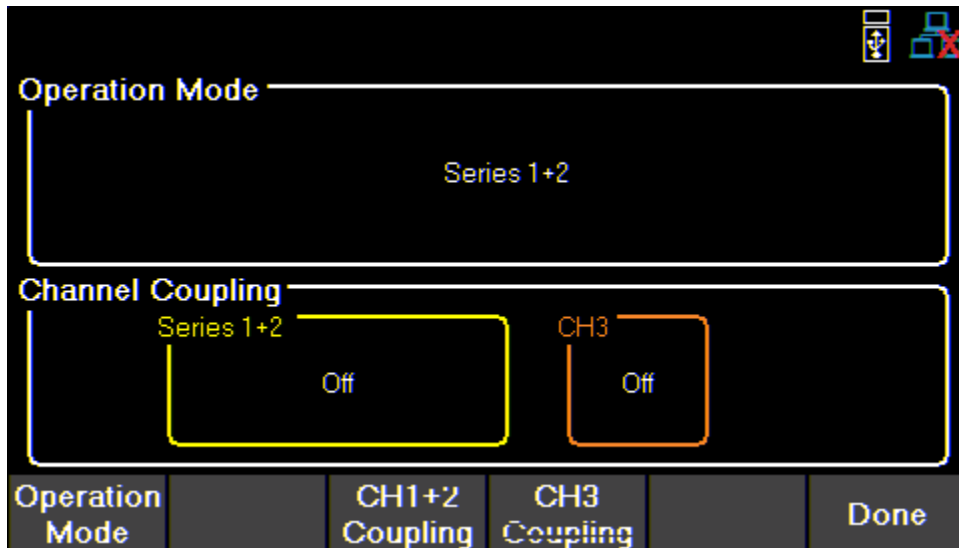

Figure 4.6 Series 1+2

In **Series CH1 + 2** the main page will display the output of the combined outputs, as well as the output of the individual CH3.

The **Home Display** button will toggle through single channel display for Series CH1 + 2, CH 3, and live output monitoring.

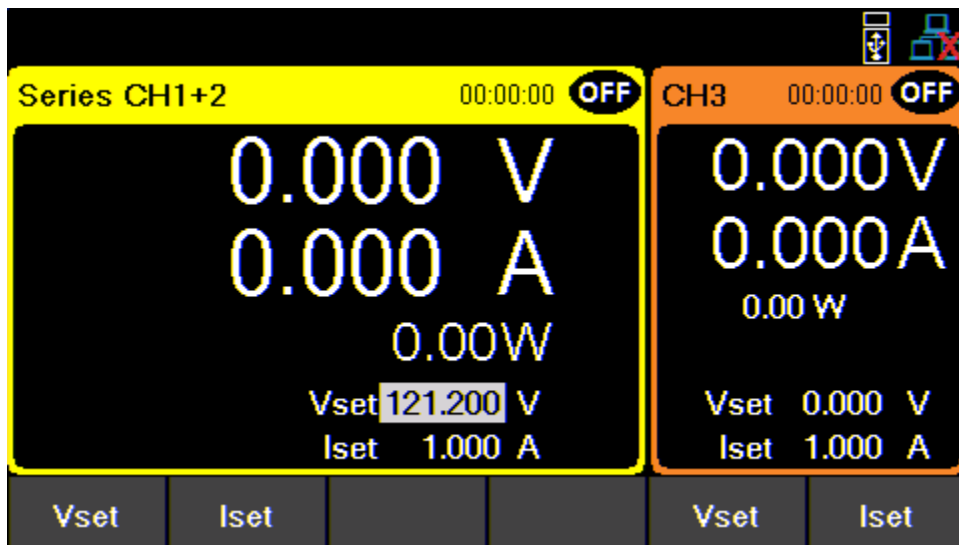

Figure 4.7 Series CH1+2 Main Page

Single CH displays more information about the output, and allows configuration of more parameters. The voltage configurations will now range from 0 v to 64 V for model 9140 and 0 V to 120 V for model 9141.



Figure 4.8 Series CH1+2 Single Channel Display

Protection Setting menu will also adjust the configurable values.

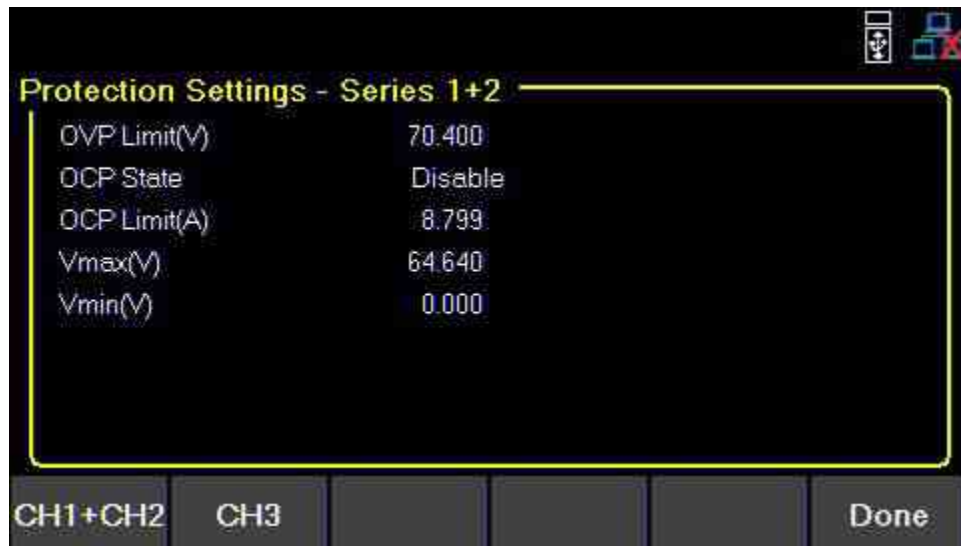

Figure 4.9 Series CH1+2 Protection Settings

Series All

Operation mode will be set to **Series All**. Coupling will not be available in **Series All** mode.

Press the **Utility** button then use the soft key to select **Output Config > Op. Mode/Coupling > Operation Mode > Series > Series All**.



Figure 4.10 Series All

In **Series All** mode **Home Display** will only toggle between the Series All display and live output monitoring.

Series All CH display will adjust to voltage configuration between 0 V and 96 V for model 9140 and 0 V to 180 V for model 9141.



Figure 4.11 Series All Main Page

Protection Setting menu will also adjust the configurable values.

Parallel Mode

Set operation mode to **Parallel**.

Parallel Mode does not internally wire the outputs. The outputs must be connected externally to increase the available current range.

Parallel Mode changes the UI to accurately represent the possible output configurations.

Press the **Utility** button then use the soft key to select **Output Config > Op. Mode/Coupling > Operation Mode > Parallel**.



The image below illustrates the external wiring required to connect all channels in **Parallel**. If CH1+ CH2 is chosen CH2's terminals do not connect to CH3's terminals.

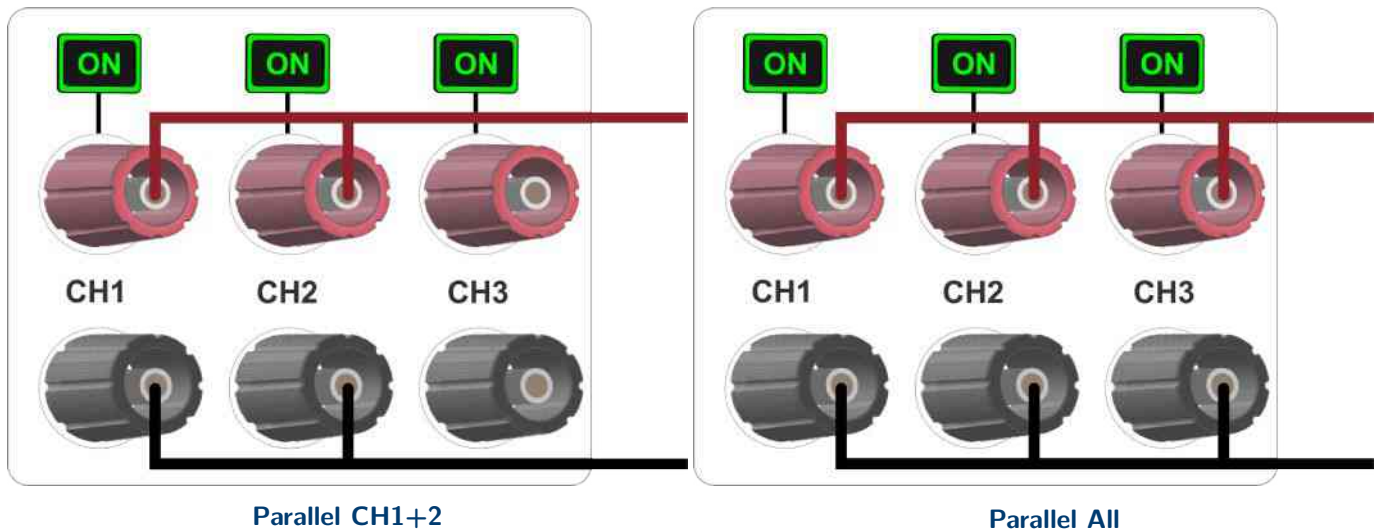

9140		9141	
CH1 + CH2	All CHs	CH1 + CH2	All CHs
16 A	24 A	8 A	12 A

Table 4.2 Parallel Mode

CH1 + CH2

Operation mode will be set to **Parallel 1 + 2**. Selecting an operation mode will undo previous coupling configuration.

Press the **Utility** button then use the soft key to select **Output Config > Op. Mode/Coupling > Operation Mode > Parallel > CH1 + CH2**.

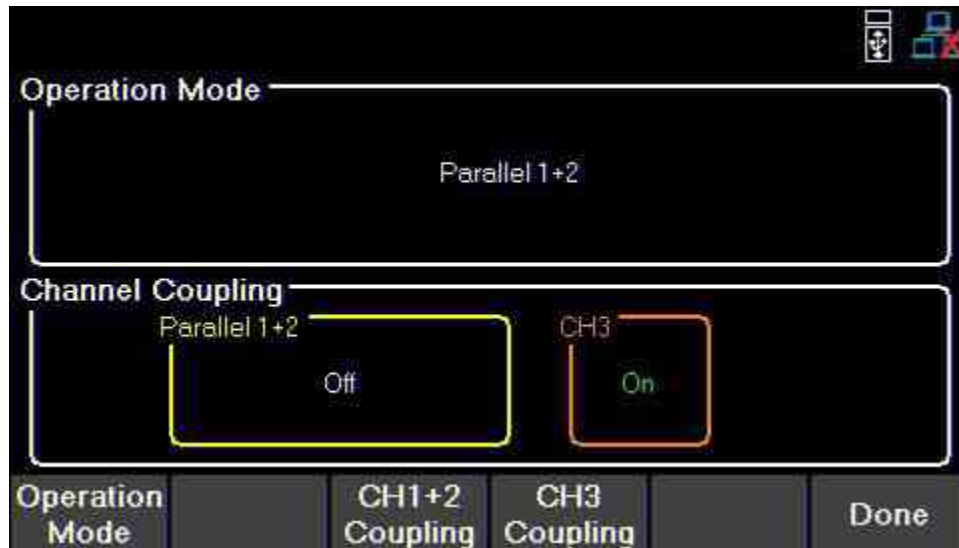

Figure 4.12 Parallel CH 1+2

In **Parallel CH1 + 2 Mode** the main page will display the output of the combined outputs, as well as the output of the individual CH3.

The **Home Display** button will toggle through single channel display for Parallel CH1 + 2, CH 3, and live output monitoring.

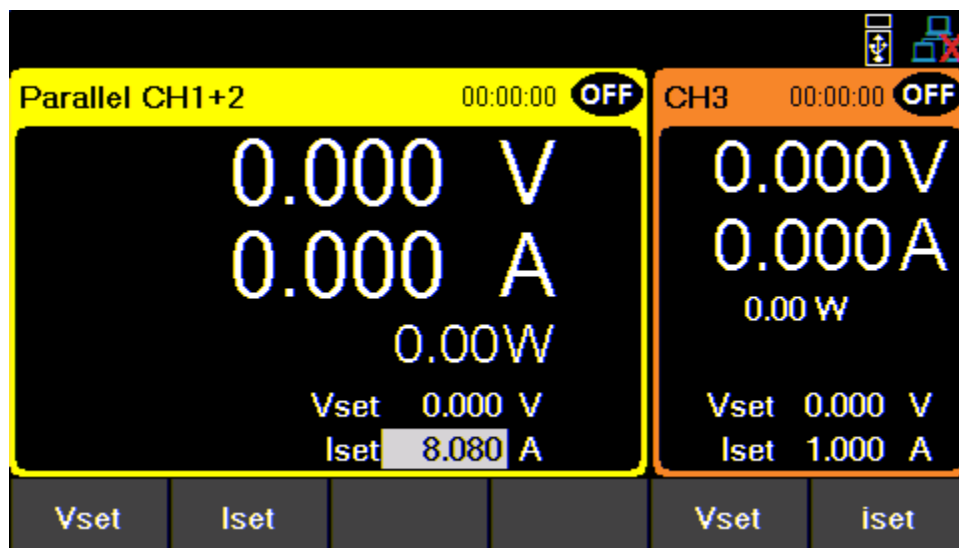

Figure 4.13 Parallel CH 1+2 Main Display 9141

The **Single CH** display will adjust to allow current configuration between .030 A to 16 A for model 9140 and .030 A to 8 A for model 9141.



Figure 4.14 Parallel CH 1+2 Single Channel Display

Protection Setting menu will also adjust the configurable range of each parameter.

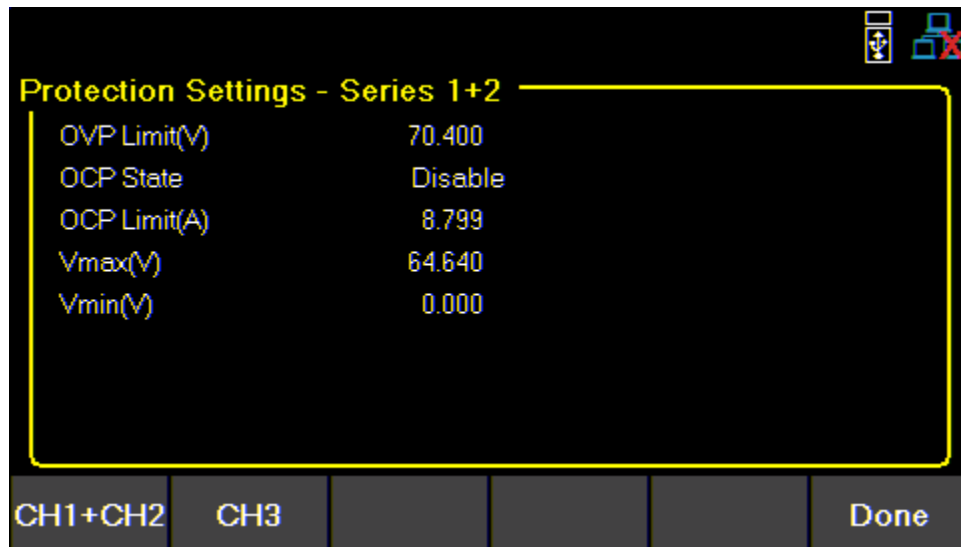

Figure 4.15 Parallel CH 1+2 Protection Settings

Parallel All

Operation mode will be updated based on selected mode. Coupling is not available.

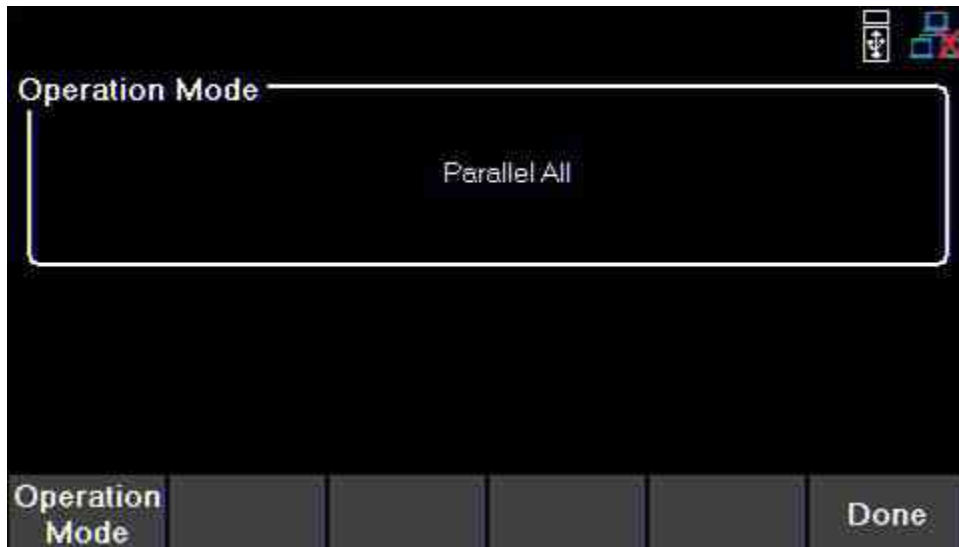

Figure 4.16 Parallel All Operation Mode

In **Parallel All Mode** the Home Display button will only toggle between the Parallel All display and live output monitoring.

Parallel All CH display will adjust to allow value configuration of .045 to 24 A for model 9140 and .045 A to 12 A for model 9141.

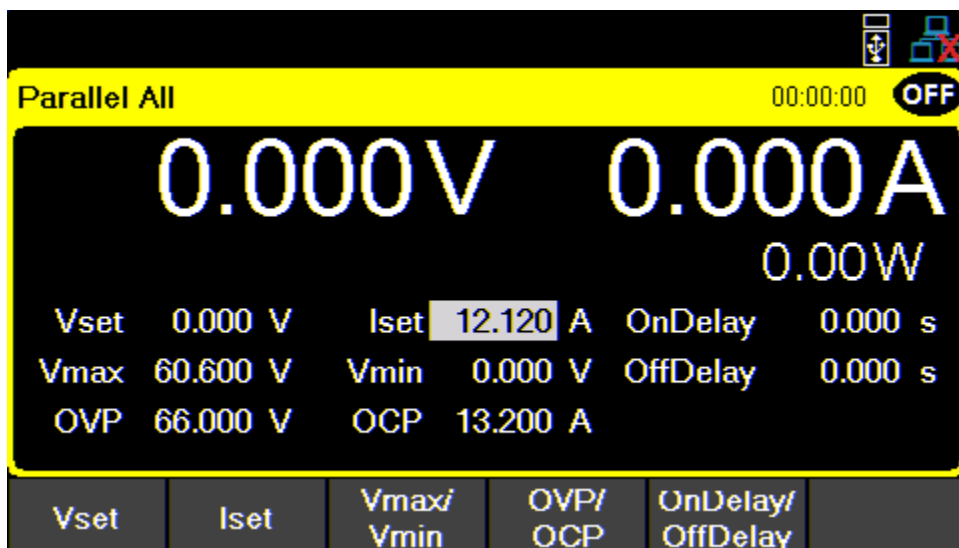

Figure 4.17 Parallel All Main Page

Protection Setting menu will also adjust the configurable values.

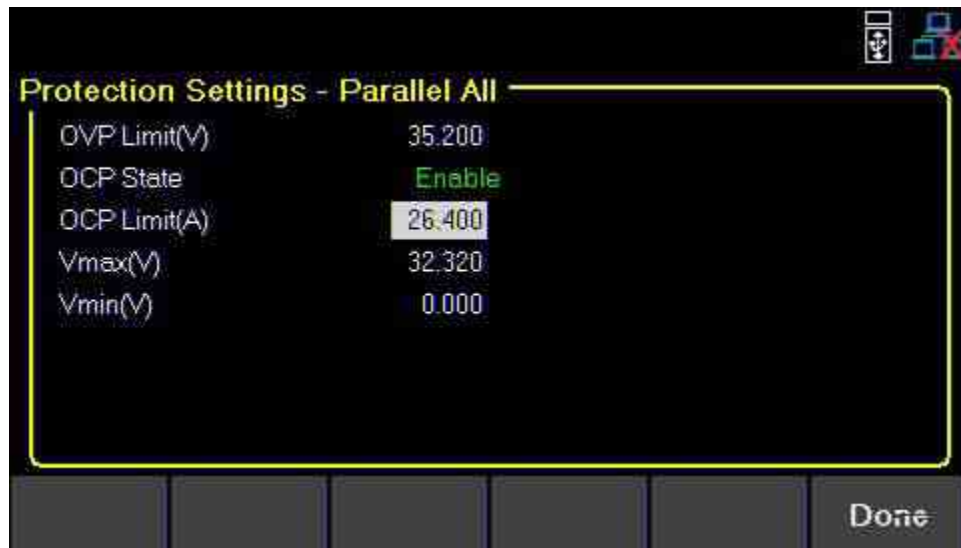

Figure 4.18 Parallel All Main Page

Tracking

Voltage levels are tracked on either CH1+2 or All Channels.

Press the **Utility** button then use the soft key to select **Output Config > Op. Mode/Coupling > Operation Mode > Tracking**.



Tracking mode allows real time voltage tracking across all channels or between CH1 and CH2.

When tracking mode is enabled, list mode will still operate independently on the channel that has list enabled. Tracking channels will not track the list changes.

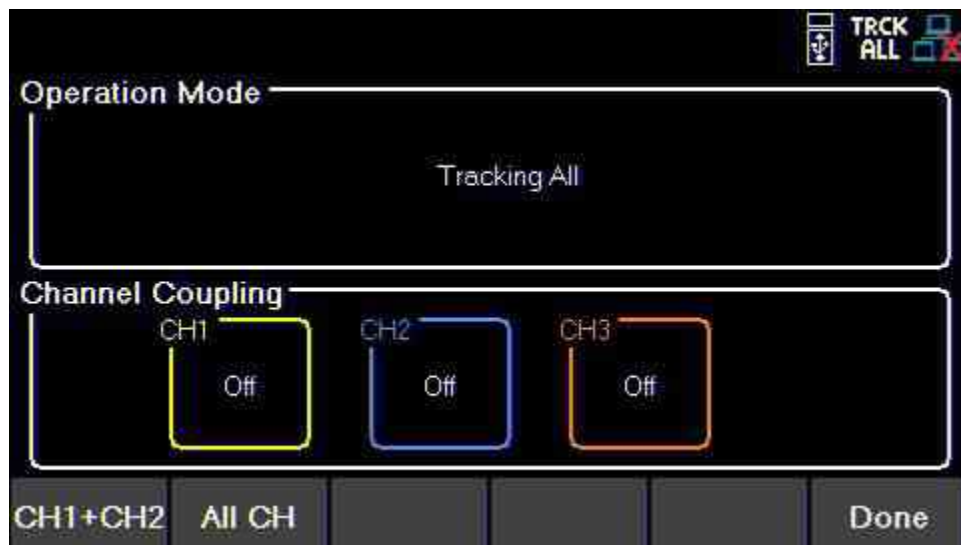

Figure 4.19 Tracking Mode

Coupling

Enable or disable the output coupling between multiple output channels, by using the soft keys to toggle individual channel coupling On or Off.

Press the **Utility** button then use the soft key to select **Output Config > Op. Mode/Coupling**

If coupling is enabled, **All CH On/Off** will follow the coupling settings. Channel output On/Off buttons will also follow the coupling settings if the correlated channel is coupled to another channel.

Example:

If CH1 and CH2 are coupled and the coupled CHs are on, **All CH On/Off** will not turn on CH3. It will turn off CH1 and CH2.

However, if all channels are OFF **All CH On/Off** will turn all CHs ON.

If all CHs are ON **All CH On/Off** will turn all CHs OFF.

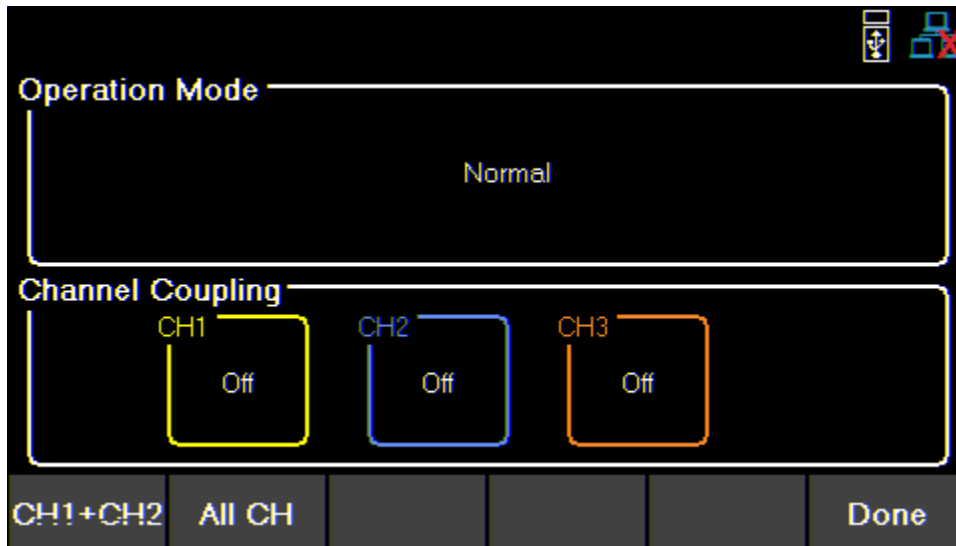

Figure 4.20 Parallel All Main Page

Output Sequencing

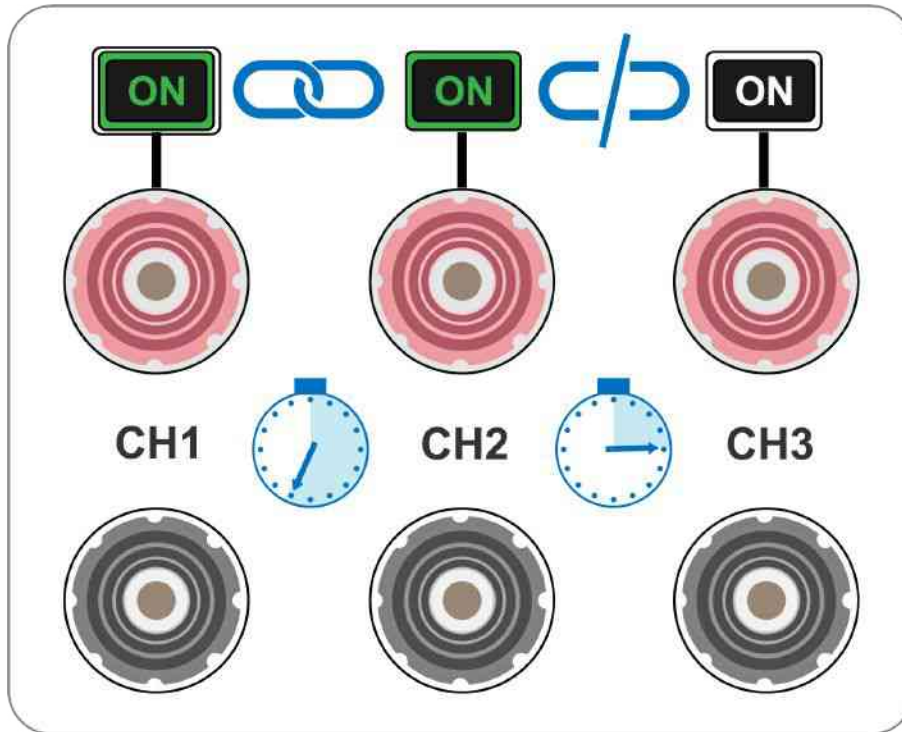

Figure 4.21 Sequencing

Combine **CH Coupling** with **Output On and Off Delay** to toggle the outputs in a set sequence.

To configure a sequence:

1. Set voltage and current output of the participating channels.
Reference section **Setting Voltage and Current**.
2. Synchronize output state by coupling of all participating channels.
Reference section **Coupling**
3. Configure the turn on order of the outputs using the **On** and **Off Delay**.
Reference section **Output Timer**

Begin the sequence by turning on any of the participating outputs.

List Mode

The 9140 and 9141 are capable of storing up to 10 programmable lists in the internal memory. Each list can have up to 100 configurable steps.

List memory is shareable across all 3 channels, allowing the channels to run the same list or different list simultaneously.

If all ten list numbers are taken, a list can also be saved to a USB. Lists can be loaded from a USB, allowing for a larger collection of programmed lists.

5.1 List Setup

Press the **Utility** button then use the soft key to select **List Setup**.

Use the softkeys to select one of the channels **CH1**, **CH2**, or **CH3**.

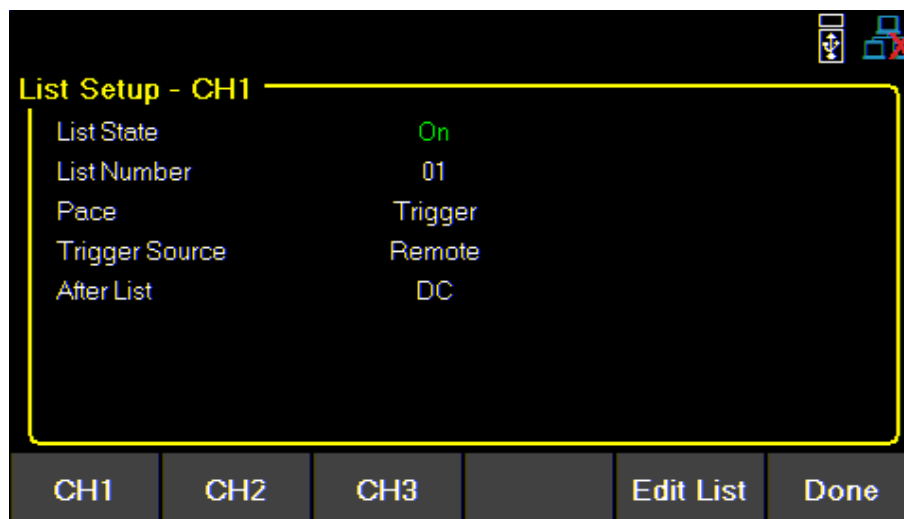

Figure 5.1 List Setup

Use the softkeys to set the following parameters.



List State:

Toggle list state **On/Off** for the selected channel.

List Number:

Select a list program from the memory to run on the channel. Use the numeric keypad or rotary knob to select list number.

Press **Enter** to assign the list to a channel.

Pace:

Set the pace in which steps are executed.

- Dwell:** The next step outputs once the dwell time elapsed.
- Trigger:** After the dwell time elapsed, wait for a trigger before outputting the next step.

Trigger Source

Set the trigger source.

- Manual:** Select to use a manual trigger. The **Trigger** softkey will be available once **List State** is on and exit out of the menu to the main display. Press it to manually trigger the list program. If the step dwell time has not elapsed, then **Trigger** will not have a white background. When dwell time elapses, **Trigger** background color will turn white to indicate the trigger is ready.



Figure 5.2 Waiting for Trigger

- Digital IO:** Select to use the digital I/O pins to receive a trigger. To assign trigger input function to a pin see [7.4.1](#).
- Remote:** Select to receive a trigger from the remote interface.

After List

Sets the voltage and current settings at the end of the list program.



- DC:** Returns to the last DC output voltage and current setting prior to enabling list mode.
- Last:** Retains the last step voltage and current setting after the list program ends.

Note:

If the list is aborted, the output will return to the last set voltage and current output values before the list began, even if **After List** is set to **Last**.

5.2 Edit List

Press the **Utility** button then use the soft key to select **List Setup > Edit List**.

Use the softkeys to set the following parameters.



5.2.1 Load/Save List

Save to USB

Save the selected list program to a USB.

Use the rotary knob to navigate through the file paths of the USB. Use the **Enter** button to expand folders. Once the desired location has been found select **Save** by pressing the softkey furthest to the left.



Figure 5.3 Save to USB

Load from USB

Load a previously saved list from a USB to selected **List Number**.

Use the rotary knob to navigate through the file paths of the USB. Use the **Enter** button to expand folders. Once the desired location has been found select **Load** by pressing the softkey furthest to the left.



Figure 5.4 Load from USB

Note:

The list must be saved/overwritten at the selected list number location before it is able to be assigned.

5.2.1 List Number

Select a list program from the internal memory.

Use the numeric keypad or rotary knob to select a list (0 to 9).

Press **Enter**

5.2.2 Next

Set the next list program to run after the current list elapse.

- To make a list run continuously and indefinitely, set **Next** to the same number as **List Number**.
- To run different list sequences continuously, set **Next** to each other.

Example

Set **Next** on List 1 to 2.
Set **Next** on List 2 to 1.

5.2.3 Repeat

To repeat a list, set **Repeat** using the numeric keypad or rotary knob and press **Enter**.

5.2.4 Steps

Add, **delete**, **clear all**, or **edit steps**.

Add Step

Use the softkeys to add a step to the list. The step added will be a duplication of the step selected before pressing **Add Step**.

To select a step to duplicate, use the rotary knob to navigate the available steps. If the list is new, only one default step will be available. Pressing **Add Step** will duplicate the default step.

The screenshot shows the 'List Mode' interface. At the top, there are three input fields: 'List Number' (01), 'Next' (00), and 'Repeat' (000000). Below these is a table with columns: Step, Voltage, Current, BOST, EOST, and Dwell. The first row contains the values: 1, 0.000, 0.015, (empty), (empty), and 0.1. Below the table is a row of softkeys: Load/Save List, List Number, Next, Repeat, Steps, and Done.

Step	Voltage	Current	BOST	EOST	Dwell
1	0.000	0.015			0.1

Figure 5.5 Default Step In New List

Delete Step

Delete the step selected before pressing **Delete Step**.
Use the rotary knob to navigate between each step.

Clear All

Clear all list parameters. See fig 5.5

Edit Step

Use the rotary knob to navigate the steps available.(select a row)

To edit parameters of the step, use the ◀ ▶ keys.(selects a column)

See figure 5.6 for the parameter each row edits.

Press **Enter** to toggle enable/disable BOST and/or EOST.



Step	Voltage	Current	BOST	EOST	Dwell
1	1.000	0.015	X		1.0
2	2.000	0.015	X		1.0
3	3.000	0.015	X		1.0
4	4.000	0.015	X		1.0

List Number: 01 Next: 00 Repeat: 000003
 Add Step Delete Step Clear All Done

Figure 5.6 List Configuration

Step Parameters

Voltage Sets Vset value.
 When setting Vset the list will not limit the voltage range based on mode. Therefore, Vmax will be 96.960 for model 9140 and 180.800 for model 9141. To prevent a protection trip, verify the Vset and Iset values in the list is within the range of the configured operation mode before running the list.

Current Sets Iset value.
 When setting Iset the list will not limit the current range based on mode. Therefore, Imax will be 24.240 for model 9140 and 12.120 for the 9141. To prevent a protection trip, verify the Vset and Iset values in the list is within the range of the configured operation mode before running the list.

BOST Press the knob or to enable/disable a trigger-out signal at the beginning of the step (BOST).

EOST Press the knob or to enable/disable a trigger-out signal at the beginning of the step (EOST).

Dwell Sets the dwell time of the selected step.

5.3 List Run

List allows a sequence of outputs with up to 100 configurable steps. With sharable memory across all three channels, a list can run simultaneously on various channels. This allows for a list to be compatible in normal, parallel or series mode.

Before running a list its parameters must be configured.

1. Configure the parameters of each step. See [5.2](#)
2. Set the settings of the channel which will output the list. See [5.1](#)
 - a. Enable **List State** on desired channel.
 - b. Assign a **List Number** to the channel.
 - c. Select **Pace** {Dwell or Trigger}.
 - d. Select **Trigger Source** {Manual, Digital IO, or Remote }.
 - e. Select **After List** output {DC or Last}.
3. After configuring the list and channel parameters press  to return to the main page.
 - **Vset** will be replaced with **List Start** if **List State** was enabled.

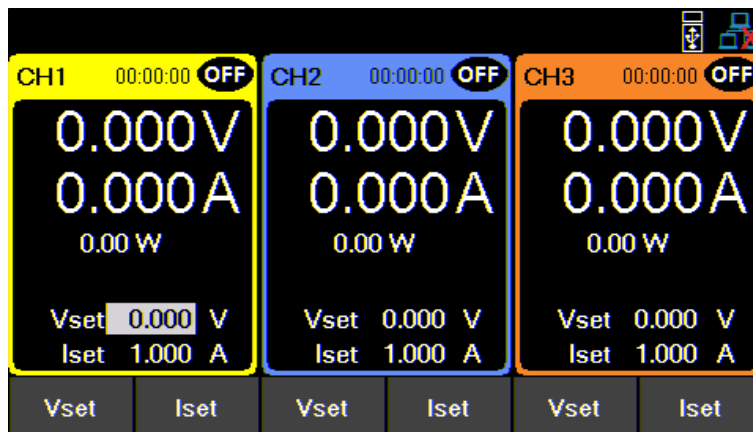

Figure 5.7 List State Disabled

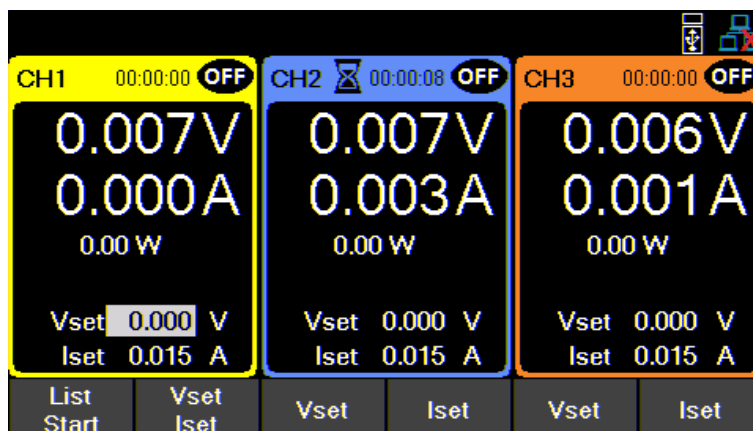

Figure 5.8 List State Enabled CH 1

4. Select List start to start the list.
 - Once the list begins **List Start** will change to **Abort List**
 - The interaction with the list will vary depending on the chosen **Pace**. See [5.1](#)
5. Select **List Abort** to end the list before all steps elapse. If the all steps elapse the list will end and the output will be set to chosen **After List** parameter.
 - If **After List** is set to **DC** the output will output the Vset and Iset values.
 - If **After List** is set to **Last** the output will output the values of the last step in the list.

Note:

While the list is running the user can adjust the current step output by setting Vset or Iset on the main display. Doing so will immediately change the value of the ongoing output. However, the set value will not be saved to the list. Once the dwell time of the step has elapsed the list will continue and output the next step.

If Trigger source is set to manual, Vset/Iset will not be available. The rotary knob and numeric keypad can be used to adjust the selected value. To adjust both Vset/Iset navigate to the single CH display of the output using the Home
Display key. Vset/Iset will be available as shown in figure [5.9](#).

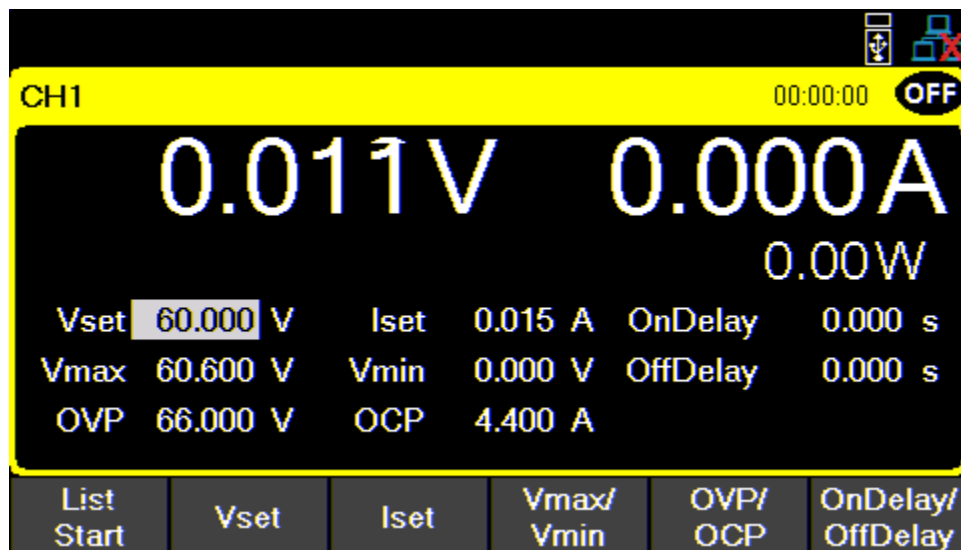

Figure 5.9 Single Channel Display Vset/Iset

Data Logger

The data logger can record the output voltage, current, and error codes of all three channels. Log data can be configured to record either Voltage only, Current only, or both.

Connect a USB flash drive to the front panel USB port. Max. Recording time will vary based on the flash drive size and the amount of the data being logged.

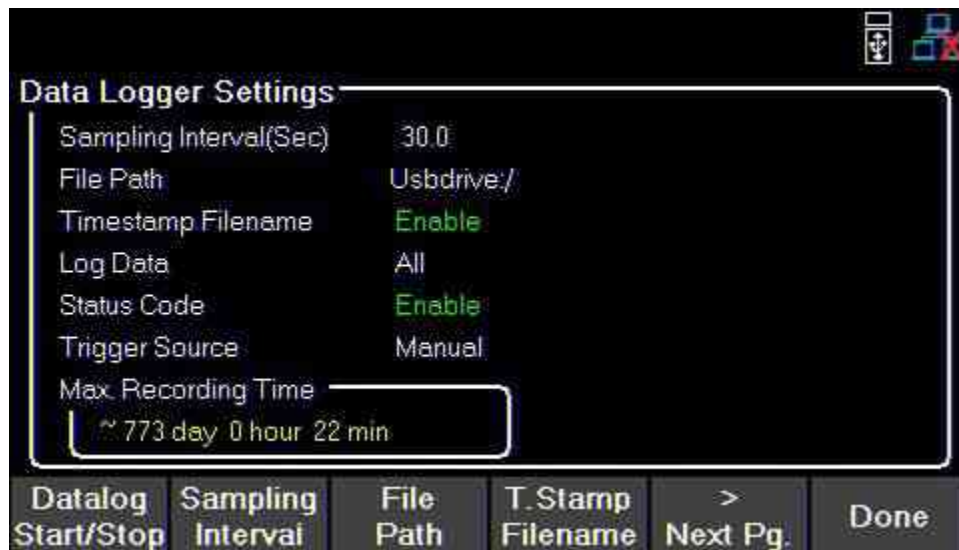

Figure 6.1 Data Logger Max Time

6.1 Using the Data Logger Function

Press the **Utility** button then use the soft key to select **Data logger**. The **Data Logger** settings can be selected in this menu.

Before starting the **Data Logger** its settings must be adjusted.

1. Set the desired **Sampling Interval** See [6.2.1](#)
2. Select a **File Path** to determine where to store the collected data. see [6.2.2](#)
3. Enable or disable **T. Stamp Filename**. See [6.2.3](#)
4. Choose what data to record. See [6.2.4](#)
5. Enable or disable **Status Code**. See [6.2.5](#)
6. Select a **Trigger Source**. See [6.2.6](#)
7. After setting all desired parameters press **datalog Start/Stop** to begin recording. Staring data log will vary based on chosen trigger. See [6.2.7](#)

6.2 Parameters

6.2.1 Sampling Interval

Press the **Utility** button then use the soft key to select **Data logger > Sampling Interval**.

Use the numeric keypad or rotary motor to select the sampling interval. Press **Enter** to assign the selected value. (.2s to 300s)

6.2.2 File Path

Press the **Enter** button then use the soft key to select **Data logger > File Path**.

Using the rotary knob and **Enter** navigate through the file path of the USB. Once the desired location has been found select **save** by pressing the softkey furthest to the left.

Verify that the correct path was chosen in the **Data Logger** menu.



Figure 6.2 File Path Selected

6.2.3 T. Stamp Filename

Press the **Enter** button then use the soft key to select **Data logger > T. Stamp Filename** Toggle to enable/disable time and date on the file name.

Example Enabled 9140_log_20201017002307
 Disabled 9140_log

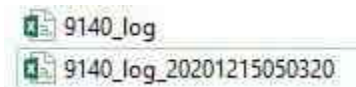

Figure 6.3 Enabled and Disabled T. Stamp

6.2.4 Log Data

Press the **Enter** button then use the soft key to select **Data logger > Next Pg. > Log Data**.

Select data to be logged.

- All: Record both voltage and current output of all channels.
- Voltage: Record the voltage output of all channels.
- Current: Record the current output of all channels.

9141 583K20101 Datalog						
Sample interval: 1.0						
Operation mode:Normal						
Log data:All						
Date: 2020-12-15 03:34:32						
1.016	0	0.014	0.002	0.01	0.001	0x0000
2.432	0	0.014	0.002	0.01	0	0x0000
3.505	0	0.013	0.002	0.01	0.001	0x0000
3.998	0	0.012	0.002	0.01	0	0x0000
4.997	0	0.012	0.001	0.01	0	0x0000
1.017	0	0.013	0.002	0.01	0	0x0000
2.005	0	0.013	0.002	0.01	0	0x0000
3.501	0	0.013	0.002	0.011	0.001	0x0000
4.504	0	0.013	0.002	0.01	0	0x0000
4.996	0	0.013	0.002	0.01	0.001	0x0000
1.012	0	0.011	0.002	0.01	0.001	0x0000
2.003	0	0.011	0.002	0.011	0.001	0x0000
3.005	0	0.011	0.002	0.011	0.001	0x0000
0.036	0	0.01	0.002	0.011	0.001	0x0001
0.019	0	0.011	0.002	0.01	0.001	0x0001
0.02	0	0.01	0.002	0.01	0.001	0x0001
0.017	0	0.014	0.002	0.011	0.001	0x0001
0.016	0	0.013	0.002	0.011	0.001	0x0001
0.017	0	0.013	0.002	0.01	0.001	0x0001
0.016	0	0.013	0.002	0.009	0.001	0x0001

Figure 6.4 Log Data All

The data is recorded in the following order:

CH1 Voltage	CH1 Current	CH2 Voltage	CH2 Current	CH3 Voltage	CH3 Current	Status Code
-------------	-------------	-------------	-------------	-------------	-------------	-------------

Table 6.1 Data Order

Note:

Data order will vary depending on **Log Data** selected.

6.2.5 Status Code

Press the  button then use the soft key to select Data logger > Status Code. Toggle to enable/disable status code.

Enabled **Status Code** will record all codes reported. See 6.4 for an example. In figure 6.4 the code 0x0001 is returned. This indicates OVP has been triggered.

Table 6.2 defines each code.

Code	Description
0x0001	Over Voltage Protection Triggered
0x0002	Over Current Protection Triggered
0x0004	Over Temperature Protection Triggered
0x0008	Sense not connected

Table 6.2 Status Code

6.2.6 Trigger Source

Press the  button then use the soft key to select **Data logger > Trigger Source**.

Datalog can be triggered in three ways: **Manual**, **Digital IO**, and **Remote**.

- **Manual**: Select to use manual trigger. The trigger softkey will be available as Datalog Start/Stop. See section 6.2.7
- **Digital IO**: Select to use the digital I/O pins to receive a trigger. To assign a function to a pin see section 7.4.1.
- **Remote**: Select to receive a trigger from a remote interface.

Note:

For **Digital IO** and **Remote** the first trigger will turn Data log on. A second trigger will begin data recording.  will be displayed on the top right when data is being logged. See 6.2.7

6.2.7 Datalog Start/Stop

Press the  button then use the soft key to select **Data logger > Datalog Start/Stop**. Toggle to turn datalog On/Off.



will be displayed on the top right when data logger is on but not recording.
The command INIT:IMM:DLOG will turn on data logger.
For **Digital IO** press **Datalog Start/Stop** to turn data logger on.



will be displayed on the top right when data logger is recording.
The command TRIG:DLOG:IMM will begin the recording.
For **Digital IO** an input high signal to the set pin will turn data logger on.

If **Trigger Source** is set to manual pressing **Datalog Start/Stop** will start/stop recording without a second signal.

Utilities Menu

Configure the settings in the following menus:

- **User Settings**
- **Remote Interface**
- **I/O Configuration**
- **Test/Admin**
- **Error Log**
- **Help**

7.1 User Settings

Press the  button then use the soft key to select **Utilities > User Settings**. The system's settings can be configured here.

7.1.1 Key Lock Output

Press the  button then use the soft key to select **Utilities > User Settings > Key Lock Output**.

Toggle to enable/disable the key lock.

- Enabling Key Lock Output changes the function of Key Lock.
- For more information see chapter **8**
- Default: OFF

7.1.2 Beep Sound

Press the  button then use the soft key to select **Utilities > User Settings > Beep Sound**.

Toggle to enable/disable the beeper sound.

Default: ON

7.1.3 Date

Press the  button then use the soft key to select **Utilities > User Settings > Date**.

Use the number pad to set the date.

YY/MM/DD

7.1.4 Time

Press the  button then use the soft key to select **Utilities > User Settings > Time**.

Use the number pad to set the time.

HH:MM:SS

7.1.5 Screen Intensity

Press the  button then use the soft key to select **Utilities > User Settings > Next Pg. > Screen Intensity**.

Use the rotary knob or number pad to set the screen brightness.

Lowest 1

Highest 10

7.1.6 Language

Press the  button then use the soft key to select **Utilities > User Settings > Next Pg. > Language**.

Set the language for the **On Screen Help** guide. It **does not** change the language for the menus. For more information about On Screen Help see section [7.8](#)

7.2 Remote Interface

The 9140 series supports remote communication on up to three interfaces: USB, LAN, and GPIB (optional).

While in remote mode the screen displays “RMT” in the upper right corner. Switching to remote mode does not impact the supply’s output parameters.

In remote mode, front panel operation is disabled. Only the Local button is enabled. Revert to manual mode by pressing

the  key or by sending the command SYST:LOC.

The webserver remote interface requires the password **BK** to login.

Select and configure the following interfaces:

- **USB**
- **LAN**
- **GPIB**

7.2.1 USB Settings

Press the **Utility** button then use the soft key to select **Utilities > I/O Config > USB Settings**. The USB device port is located in the rear-panel. See [1.8](#)

The 9140 series are both USBTMC and USB VCP compliant.

In the **USB Settings** menu use the soft keys to select either:

- USBVCP
- USBTMC

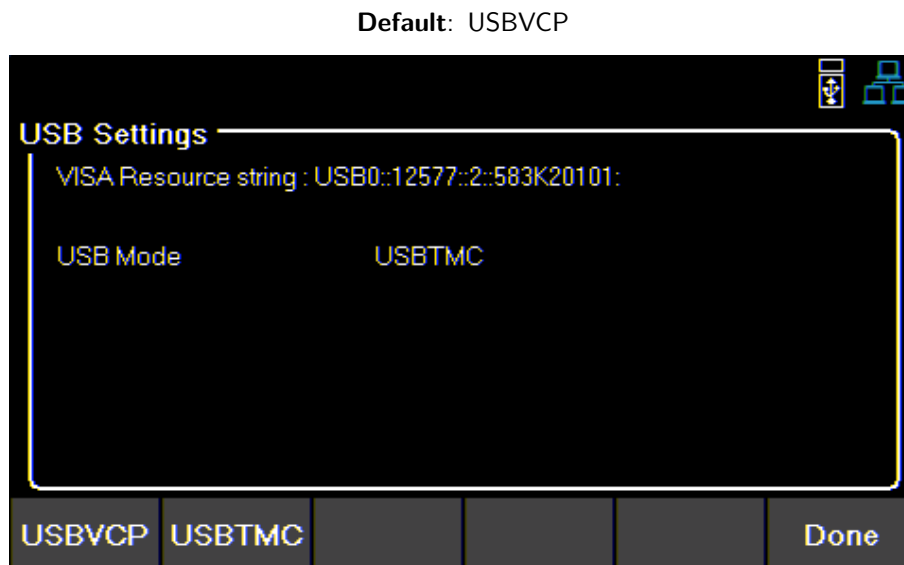

Figure 7.1 USB Details

The VISA Resource string gives USB0::<Vendor ID>::<Product ID>::<Serial Number>:INSTR

Example From figure [7.1](#) :

- <Vendor ID> = 0x3121
- <Product ID> = 0x0001 for 9140 or 0x0002 for 9141
- <Serial Number> = 583k20101

When using USBVCP set the port setting to:

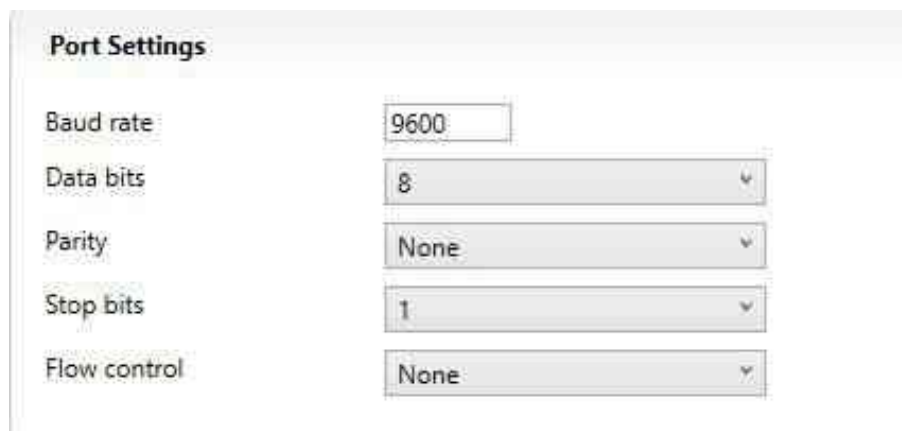

Figure 7.2 USB Port Settings

7.2.2 LAN

To configure the **LAN Settings**

Press the **Utility** button then use the soft key to select **Utilities > I/O Config > LAN Settings**. The following settings are available in **LAN Settings**:

- **IP Mode**
- **IP Address**
- **Subnet Mask**
- **Gateway IP**
- **Primary DNS**
- **Hostname**
- **LAN Reset**
- **Restore Default**
- **LAN Status**



Figure 7.3 LAN Settings

Note:

To access the webserver remote interface enter the default password **bk**.

IP Mode

Select **Dynamic Host Configuration Protocol (DHCP)** or **Manual** to set how the LAN settings will be configured.

Press the **Utility** button then use the soft key to select **Utilities > I/O Config > LAN Settings > IP MODE**.

The easiest way to configure the LAN settings is to set the IP Mode to **DHCP**. **DHCP** will automatically assign an IP address to the instrument.

The settings can manually be configured by selecting **Manual**.

IP Address

The **IP Address** is a unique string of numbers separated by periods. To enter an IP address:

Press the **Utility** button then use the soft key to select **Utilities > I/O Config > LAN Settings > IP Address**.

Use the numeric keypad to enter an IP address. Then **◀ ▶** keys are used to separate each number in the string. After inputting each number press **Enter** to set the address.

Subnet Mask

Subnet Mask divides the IP address into network address and host address.

To set **Subnet Mask**:

Press the  button then use the soft key to select **Utilities > I/O Config > LAN Settings > Subnet Mask**.

Use the numeric keypad to enter the subnet mask. Then   keys are used to separate each number in the string.

After inputting each number press  to set the address.



Gateway IP

The gateway address is by default the IP address of the network device that connects the instrument.

If **IP Mode** is set to DHCP **Gateway IP** does not have to be set.

To set **Gateway IP** :

Press the  button then use the soft key to select **Utilities > I/O Config > LAN Settings > Gateway IP**.

Use the numeric keypad to enter an IP address. Then   keys are used to separate each number in the string. After inputting each number press  to set the address.



Primary DNS

Domain Name Service (DNS) is the system that automatically translates Internet addresses to the numeric machine addresses. The DNS address is the IP address of the system that performs this service.

If **IP Mode** is set to DHCP DNS will automatically be set.

To set the **Primary DNS** :

Press the  button then use the soft key to select **Utilities > I/O Config > LAN Settings > Primary DNS** .

Use the numeric keypad to enter an IP address. Then   keys are used to separate each number in the string. After inputting each number press  to set the address.

Hostname

Each instrument comes with a unique hostname that can be changed. The default hostname has the following format:

BK-<modelnumber>--<Serialnumber>

Figure 7.3 shows the example:

BK-9141-20101

LAN Reset

LAN Reset resets all LAN settings and webpage passwords. The default webpage password is **bk**.

To reset LAN :

Press the **Utility** button then use the soft key to select **Utilities > I/O Config > LAN Settings > LAN Reset** .

Before resetting a warning will display informing both LAN settings and webpages passwords will be reset.

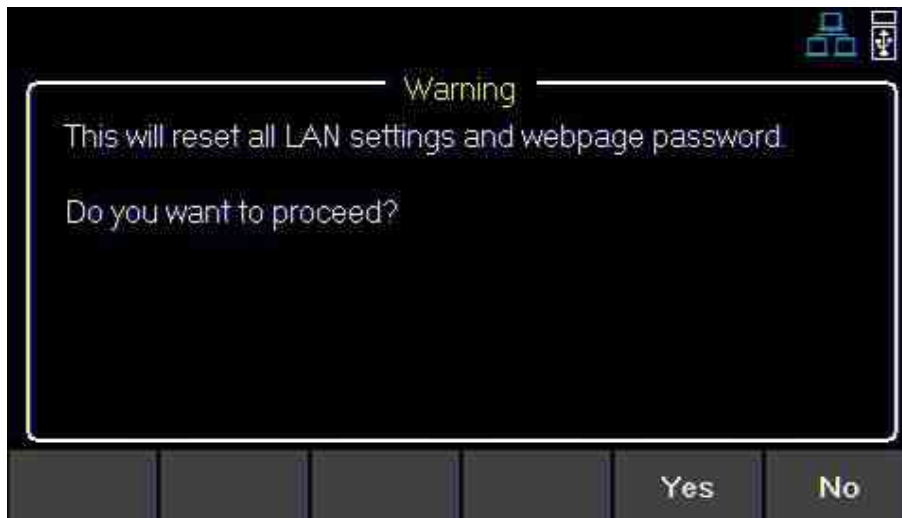

Figure 7.4 Reset

Select **Yes** to finalize the reset.

Restore Default

Restore Default will set all LAN settings to their factory defaults.

To restore factory defaults:

Press the **Utility** button then use the soft key to select **Utilities > I/O Config > LAN Settings > Restore Default** .

Before restoring LAN settings to default the following warning will display.

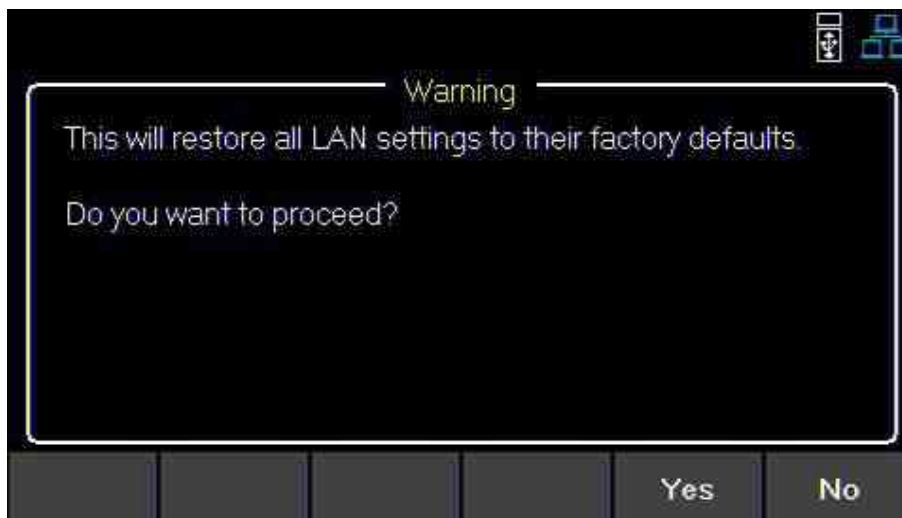

Figure 7.5 Restore Factory Defaults

Select **Yes** to set to factory default.

LAN Status

LAN Status provides an overview of the LAN settings.

To view the LAN status:

Press the **Utility** button then use the soft key to select **Utilities > I/O Config > LAN Status** .



Figure 7.6 LAN Status

7.3 GPIB (optional)

In **GPIB** the GPIB address can be changed from 01 to 30.

To change the GPIB address:

Press the **Utility** button then use the soft key to select **Utilities > I/O Config > GPIB**.

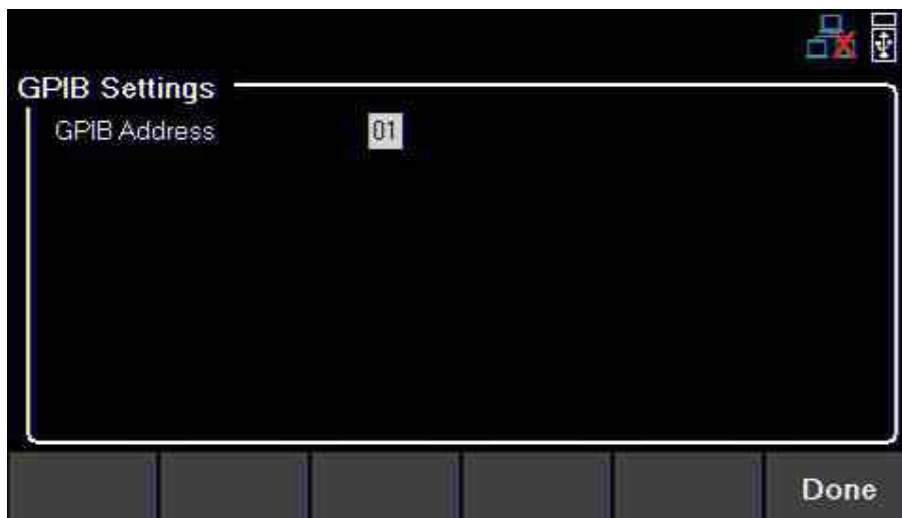

Figure 7.7 GPIB Address

Use the numeric keypad to enter the new address, then press the **Enter** key.

The rotary knob can also be used to set the address. **Enter** must be pressed to set the new address.

7.4 Digital I/O

To enter the **Digital I/O** menu:

Press the **Utility** button then use the soft key to select **Utilities > I/O Config > Digital I/O**.

Select the function and polarity of pins: 1, 2, and 3.

- **Pin Functions**
 - None
 - Digital In | Out
 - Trigger In | Out
 - Fault Out/Inhibit In
 - Polarity Pos | Neg
- **Inhibit Mode**
 - Off
 - Latched
 - Live

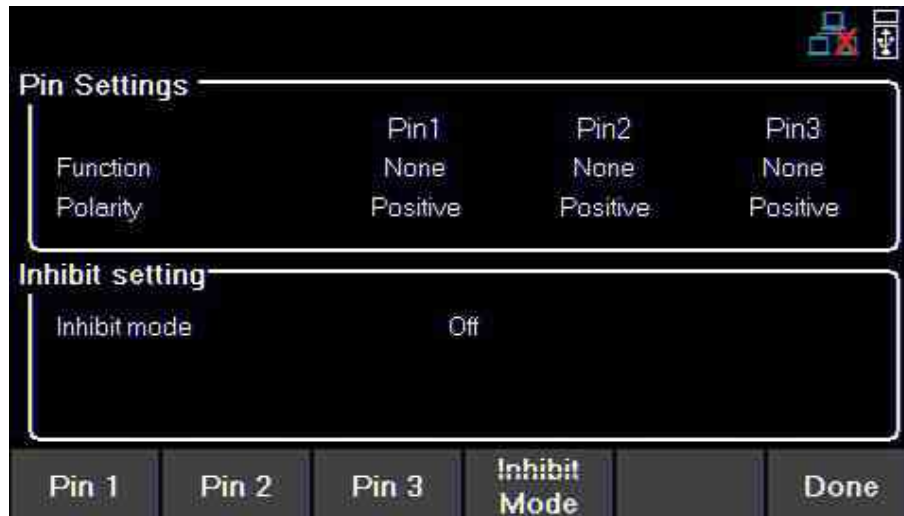

Figure 7.8 Digital I/O Menu

7.4.1 Functions

Default: None

To configure a pin:

Press the **Utility** button then use the soft key to select **Utilities > I/O Config > Digital I/O > Pin(#)**.

None

Set selected pin to have no function.

Digital In | Out

Toggle to select In/Out digital function.

Digital In: Receive a signal from external device.

Digital Out: Send a signal to external device.



The input voltage range for digital I/O pins is 0 V to 5 V. To prevent damage to the instrument, do not exceed 5 V or supply a negative voltage to the digital I/O pins.

Trigger In | Out

Toggle to select In/Out trigger function.

Trigger In: Receives signal that triggers set event.

Trigger Out: Sent trigger signal when specified. (BOST or EOST)

In **List Mode**, the **Trigger In** function can be used to trigger the next step when **Trigger Source** is set to **Digital IO**.

In **Datalog**, the **Trigger In** function can be used to start/stop data logging when **Trigger Source** is set to **Digital IO**.

Trigger Out is only available for list mode, step BOST and EOST.

Fault Out

Enable a fault condition, which generates a protection fault signal on the digital port.

Different conditions such as over voltage, over current, or over temperature will generate a fault event.

The fault event will “disable” all outputs without turning them off.

The outputs are “disabled” by setting the outputs as low as possible.

7.4.1 Polarity

Default: Positive

Set polarity of selected pin.

Positive

A logic true signal is received as a voltage high.

Negative

A logic true signal is received as a voltage low.

7.4.1 Inhibit Mode

Receive an external input signal that controls the output state of all channels.

Default: Off

To set **Inhibit Mode**:

1. Assign the **inhibit In** function to pin 3 by:

Press the  button then use the soft key to select **Utilities > I/O Config > Digital I/O > Pin 3 > Inhibit In**.

2. Select Inhibit Mode: Press the  button then use the soft key to select **Utilities > I/O Config > Digital I/O > Inhibit Mode**.
3. Select one of the following modes:

Note:

The following modes are only available for pin 3.

Off

The inhibit input is ignored.

Latched

A logic-true transition signal will disable the power supply. The output will remain disabled.

Live

Power supply output follows the state of the inhibit signal. If the inhibit signal is true the output is disabled. When it is false the output is enabled.

7.5 Test/Admin

7.5.1 Self Test

Run a Module test.

Press the  button then use the soft key to select **Utilities > Test/Admin > Self-Test > Start**.

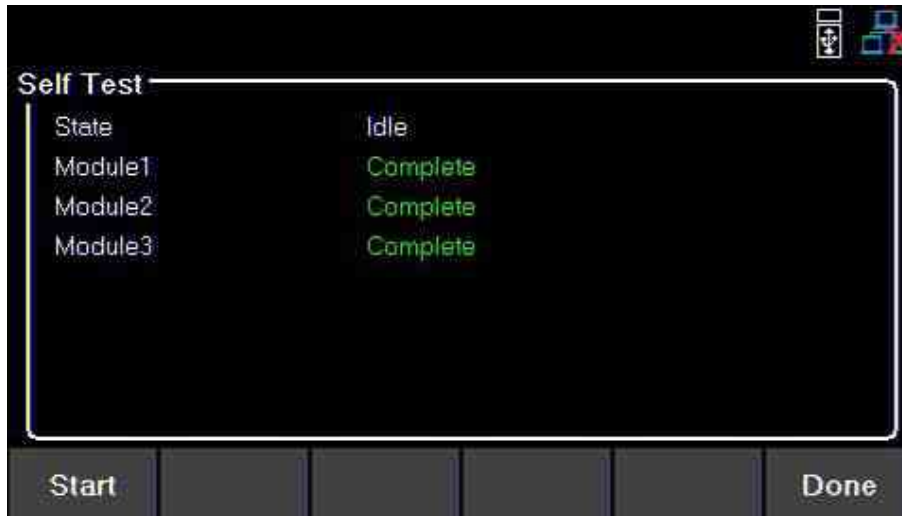

Figure 7.9 Self Test Complete

7.5.2 Security

The **Security Settings** are locked and can be accessed by entering the default code **77416699**.



Figure 7.10 Security Locked

Note:

The default password can be change in the Change Code menu. If the set code is forgotten contact B&K Precision customer support.

Use the password to gain access to the following settings.

- **Change Code**
- **Calibrate**
- **Firmware Update**
- **NISPOM**
- **Lock**



Change Code

Changes the security code.

Press the **Utility** button then use the soft key to select **Utilities > Test/Admin > Security > Change Code**.

Calibrate

Enter calibration mode.

Press the **Utility** button then use the soft key to select **Utilities > Test/Admin > Security > Calibrate** .
See chapter **Calibration Adjustment Procedure** to adjust the units calibration.

Firmware Update

Update the firmware and module. Press the **Utility** button then use the soft key to select **Utilities > Test/Admin > Security > Firmware Update** .

NISPOM

Select for complete memory wipe. Press the **Utility** button then use the soft key to select **Utilities > Test/Admin > Security > NISPOM** .

Lock

Sets security status to Lock. Press the **Utility** button then use the soft key to select **Utilities > Test/Admin > Security > Lock** .

If **Done** is selected without locking the security settings, the user will be prompted that the security settings will not be locked.

7.6 Error Log

View up to 50 previously set error codes.

Press the **Utility** button then use the soft key to select **Utilities > Error Log**.

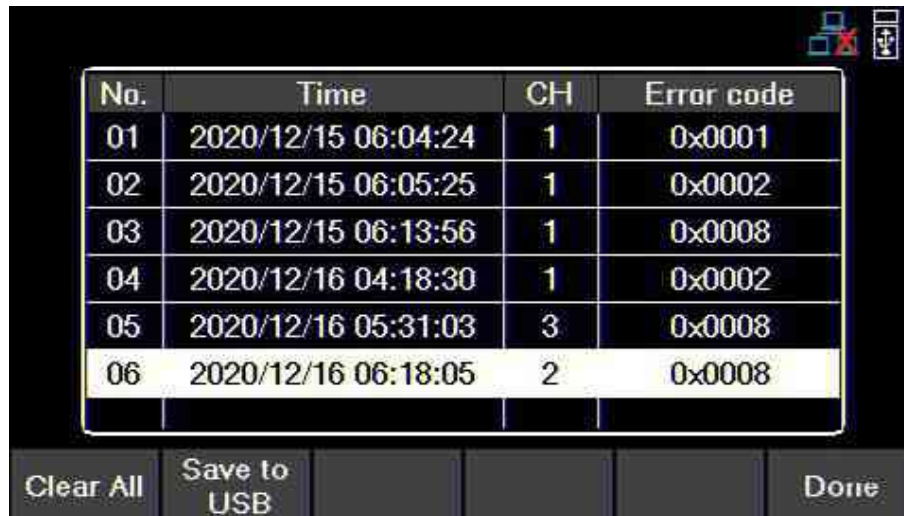

No.	Time	CH	Error code
01	2020/12/15 06:04:24	1	0x0001
02	2020/12/15 06:05:25	1	0x0002
03	2020/12/15 06:13:56	1	0x0008
04	2020/12/16 04:18:30	1	0x0002
05	2020/12/16 05:31:03	3	0x0008
06	2020/12/16 06:18:05	2	0x0008

Clear All Save to USB Done

Figure 7.11 Error Log

Errors are placed in the order that they were encountered. 1 being the most recent.

The error log displays up to 50 error codes.

After reaching 50 error codes no more codes will be reported in the error log.

To continue filing error codes the error log list must be cleared

The error log can be saved into a USB flash drive connected to the USB port on the front panel.

Save the log by:

Pressing the **Utility** button then use the soft key to select **Utilities > Error Log > Save**.

Use the rotary knob and the **Enter** button to navigate through the file path of the USB. Once the desired location has been found select **Save** by pressing the softkey furthest to the left.

Clear the data log by:

Pressing the **Utility** button then use the soft key to select **Utilities > Error Log > Clear All > Yes**.

Code	Description
0x0001	Over Voltage Protection Triggered
0x0002	Over Current Protection Triggered
0x0004	Over Temperature Protection Triggered
0x0008	Sense not connected

Table 7.1 Status Code

7.7 Help

To enter the Help menu:

Press the **Utility** button then use the soft key to select **Utilities > Help**.

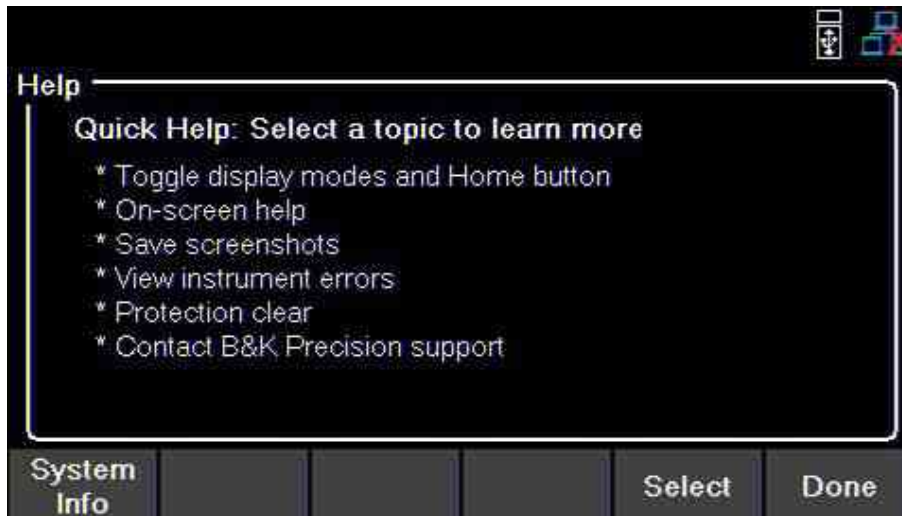

Figure 7.12 Help Menu

Use the rotary knob to navigate the help options shown in figure 7.12.

To select the Quick help topic press the **Enter** key or press the **Select** softkey.

System Info

To view the instrument's general information:

Press the **Utility** button then use the soft key to select **Utilities > Help > System Info**.

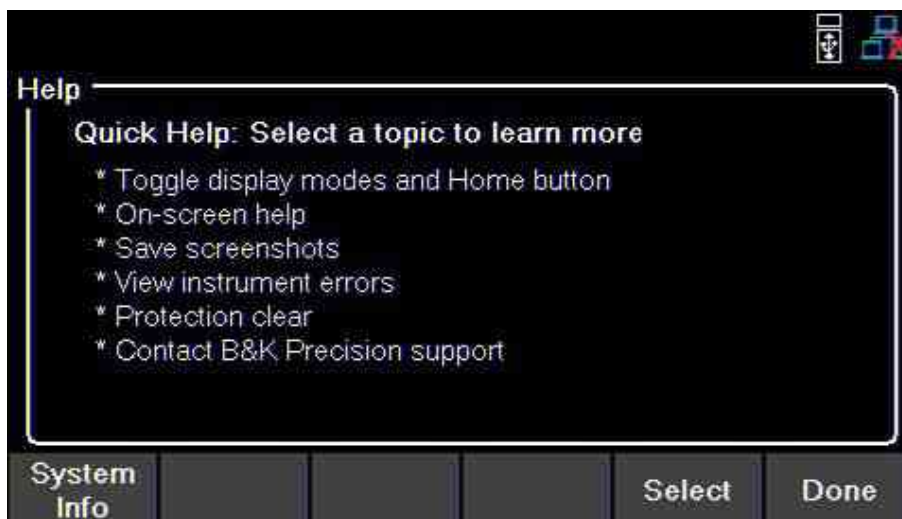

Figure 7.13 System Info

7.8 On Screen Help

Press and hold any soft key that selects a menu branch for 3 seconds to receive an explanation of what can be found in that branch.

Key Lock

Lock all front panel keys including **ON** and **All CH On/Off**.

Press the **Utility** button then use press and hold the soft keys **Key Lock** for 3 seconds.



Figure 8.1 Key Lock

If **Key Lock Output** is enabled, holding Key Lock for 3 seconds locks all front panel keys except **ON** and **All CH On/Off**. See section [7.1.1](#) to enable/disable Key Lock Output.

To unlock the front panel use the softkey to select **Unlock**.

Save/Recall

Save/Recall the instruments Output Settings and Power-On Settings.

9.1 Save the Output Settings

Save to Internal Memory

Save the instrument's output settings to the internal memory. A total of 10 (0 to 9) output settings can be saved.

To save the output settings :

Press the  button then use the soft keys to select **Save > Save to INT**.

Using the numeric keypad enter a number from 0 to 9 to save the output settings to that address. The settings will be saved after a short delay.

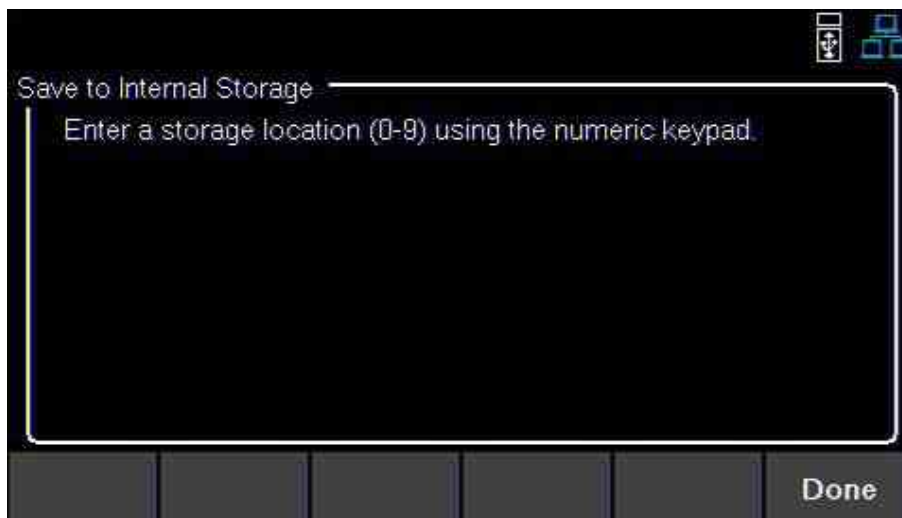

Figure 9.1 Save to Internal Storage

Save to USB

Save the instrument's output settings to a USB flash drive connected to the front panel USB host port.

Press the  button then use the soft keys to select **Save > Save to USB**.

Using the rotary knob navigate through the file paths of the USB. Use the  button to expand folders. Once the desired location has been found press **Save**. The output settings will be saved after a short delay.



Figure 9.2 Save to USB

9.2 Recall the Instrument's Settings

Recall previously saved output settings from the internal memory. A total of 10 (0 to 9) user settings can be saved.

To recall settings :

Press the  button then use the soft keys to select **Recall** > **Recall from INT**.

Use the numeric keypad to enter a number from 0 to 9 to recall the output settings stored in that address. The settings will be recalled after a short delay.

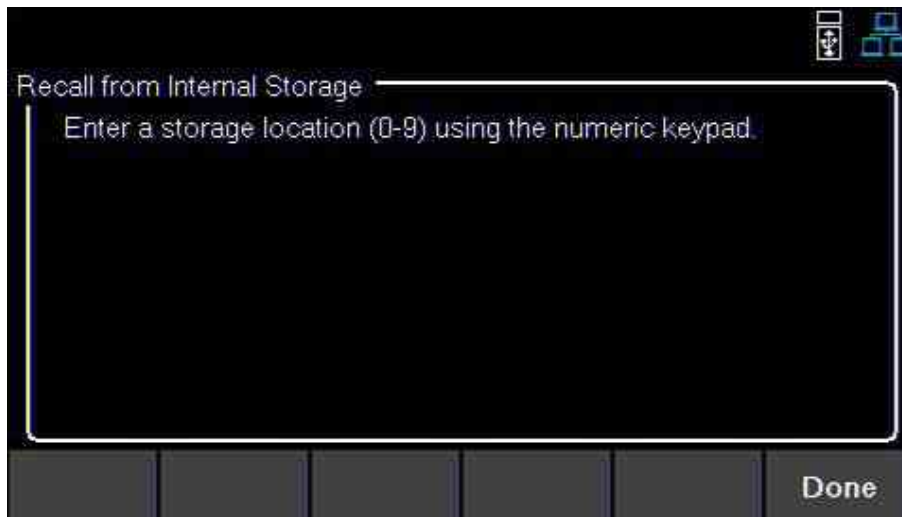



Figure 9.3 Recall from Internal Memory

Recall from USB

Recall the instrument's output settings from a USB drive.

Press the  button then use the soft keys to select **Recall** > **Recall from USB**.

Use the rotary knob to navigate through the file paths of the USB. Use the **Enter** button to expand folders. Once the desired location has been found press **Load**. The settings will be recalled after a short delay.



Figure 9.4 Recall from USB

9.3 Power-On Settings

Load previously saved output parameters on power-on.

Off

To turn off **Power-On Mode**:

Press the **SAVE Recall** button then use the soft keys to select **Power-On Settings** > **Power- On Mode** > **Off**.

Last

To set the output parameters to the previous parameters before powering-off the instrument: Press the **SAVE Recall** button then use the soft keys to select **Power-On Settings** > **Power- On Mode** > **Last**.

User

To set the output parameters previously saved parameters:

- Press the **SAVE Recall** button then use the soft keys to select **Power-On Settings** > **Power- On Mode** > **User**.
- Press the **SAVE Recall** button then use the soft keys to select **Power-On Settings** > **User Settings**.
- Use the numeric keypad or the rotary knob to assign an address (0 to 9).

To save settings see [9.1](#).

Default Values and Ranges

Set the instrument's output settings to default.



Press the  button then use the soft keys to select **Set to Default**.

Parameter	9140			9141			Unit
	Default	Max	Min	Default	Max	Min	
VSET	0	32.32	0	0	60.6	0	V
ISET	1	8.08	.015	1	4.04	.015	A
Vmax	32.32	32.32	0	60.6	60.6	0	V
Vmin	0	32.32	0	0	60.6	0	V
Vslew	1600	3200	0.001	600	3000	0.001	V/s
Islew	500	800	1	100	200	1	A/s
OVP Limit	35.2	35.2	0	66	66	0.000	V
OCP Limit	8.8	8.800	0.015	4.4	4.4	0.015	A
Timer	0	99:59:59	0	0	99:59:59	0	HH:MM:SS
On Delay	0	3600	0	0	3600	0	Sec
Off Delay	0	3600	0	0	3600	0	Sec
Datalogger Sampling Interval	0.2	300	0.200	0.2	300	0.2	Sec
List Dwell	0.1	9999	0.1	0.1	9999	0.1	Sec
List Voltage	1	96.96	0	1	181.8	0	V
List Current	.015	24.24	.015	.015	12.12	.015	A
List Repeat	0	100000	0	0	100000	0	

Table 9.1 Default Values & Ranges

9.4 Screenshot

To take a screenshot:

Press  +  together for 3+seconds until you hear a beep.

A USB must be plugged in for this function.

Calibration Adjustment Procedure

Calibration Interval

The recommended calibration interval for the 9140 series is one year.

To enter the **Calibration Menu**:

Press the **Utility** button, then use the soft key to select **Utilities > Test/Admin > Security > Calibrate**.

In the **Calibration Menu** use the softkeys to select a parameter from the menu to calibrate.

- **Voltage**
- **Current**
- **OVP**
- **OCP**
- **RTC**

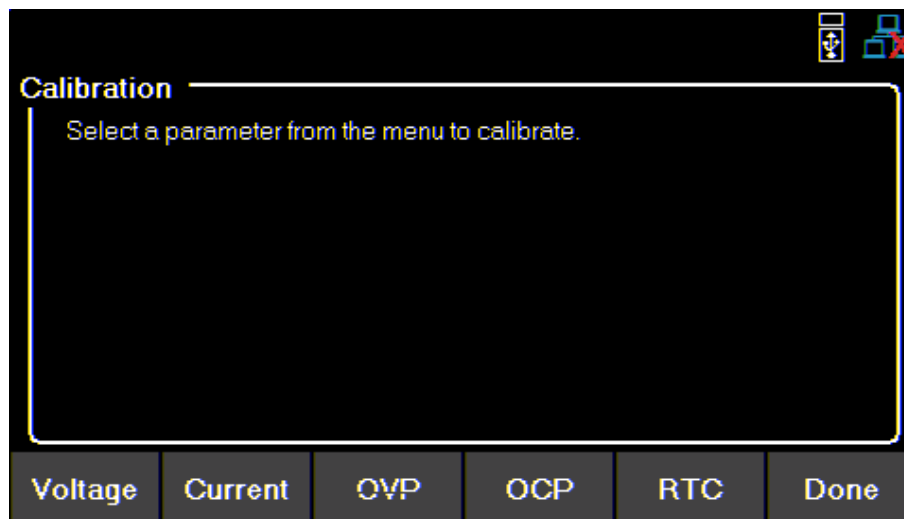



Figure 10.1 Calibration Parameters

10.1 Voltage Calibration Adjustment

For the voltage calibration procedure a precise DMM will be needed.

To adjust the voltage calibration:

1. Enter the **Calibration Menu**

- Press the  button, then use the soft key to select **Utilities > Test/Admin > Security**.

Use the numeric keypad to enter security code. See the subsection **Security**. Press the  button to enter the security menu.

2. Use the softkeys to select **Voltage > CH {1 |2 |3}**.

3. Verify the correct channel is chosen.

- The upper left corner will display the chosen channel. Voltage Calibration will have a frame with the color corresponding to the chosen channel.
 - Yellow = CH 1
 - Blue = CH 2
 - Orange = CH 3

4. Connect the DMM's voltage input to the power supply's binding post corresponding to the selected channel.

5. Use the softkey to select **Start**.

6. Use the numeric keypad to enter the measured voltage. Press the  button to configure the point.

7. Repeat step 6 for the remaining calibration points.

- Upon entering the last calibration point value the display will return to the channel selection screen.

8. Repeat steps 2 through 7 to calibrate the remaining channels.

10.2 Current Calibration Adjustment

For the current calibration procedure a precise DMM will be needed.

To adjust the current calibration:

1. Enter the **Calibration Menu**

- Press the  button, then use the soft key to select **Utilities > Test/Admin > Security**.

Use the numeric keypad to enter security code. See the subsection Security. Press the  button to enter the security menu.

2. Use the softkeys to select **Current > CH {1 |2 |3}**.

3. Verify the correct channel is chosen.

- The upper left corner will display the chosen channel. Current Calibration will have a frame with the color corresponding to the chosen channel.
 - Yellow = CH 1
 - Blue = CH 2
 - Orange = CH 3

4. Connect the DMM current input to the power supply's binding post corresponding to the selected channel.

Note:

Upon entering a calibration point the unit will immediately output the next current point. To avoid blowing the DMM's fuse ensure the correct DMM's input is chosen.

The points' output are as follows:

9140

1st Point 0.4 A
 2nd Point 2.8 A
 3rd Point 5.5 A
 4th Point 8.0 A

9141

1st Point 0.2 A
 2nd Point 1.4 A
 3rd Point 2.7 A
 4th Point 4.0 A

5. Use the softkey to select **Start**.

6. Use the numeric keypad to enter the measured current. Press the  button to configure the point.

7. Repeat step 6 for the remaining calibration points.

- Upon entering the last calibration point value the display will return to the channel selection screen.

8. Repeat steps 2 through 7 to calibrate the remaining channels.

10.3 OVP Calibration Adjustment

For the over voltage protection calibration the instrument's voltage must be calibrated.

To adjust the OVP calibration:

1. Enter the **Calibration Menu**

- Press the  button, then use the soft key to select **Utilities > Test/Admin > Security**.

Use the numeric keypad to enter security code. See the subsection Security. Press the  button to enter the security menu.

2. Use the softkeys to select **OVP > CH {1 |2 |3}**.

3. Verify the correct channel is chosen.

- The upper left corner will display the chosen channel. OVP Calibration will have a frame with the color corresponding to the chosen channel.
 - Yellow = CH 1
 - Blue = CH 2
 - Orange = CH 3

4. Connect the DMM's voltage input to the power supply's binding post corresponding to the selected channel.

5. Use the softkey to select **Start**.

6. **Calibration State** will show as **Busy**. After a few seconds the calibration will be adjusted on its own.

7. Upon successfully completing the calibration adjustment a different channel can be selected.

8. Repeat steps 2 through 6 to calibrate the remaining channels.

10.4 OCP Calibration Adjustment

For the over current protection calibration the instrument's current must be calibrated.

To adjust the OCP calibration:

1. Enter the **Calibration Menu**

- Press the  button, then use the soft key to select **Utilities > Test/Admin > Security**.

Use the numeric keypad to enter security code. See the subsection Security. Press the  button to enter the security menu.

2. Use the softkeys to select **OCP > CH {1 |2 |3}**.

3. Verify the correct channel is chosen.

- The upper left corner will display the chosen channel. OCP Calibration will have a frame with the color corresponding to the chosen channel.
 - Yellow = CH 1
 - Blue = CH 2
 - Orange = CH 3

4. Connect the DMM's 10 A input to the power supply's binding post corresponding to the selected channel.

5. Use the softkey to select **Start**.

6. **Calibration State** will show as **Busy**. After a few seconds the calibration will be adjusted on its own.

7. Upon successfully completing the calibration adjustment a different channel can be selected.

8. Repeat steps 2 through 6 to calibrate the remaining channels.

10.5 RTC Calibration Adjustment

To adjust the Real-Time Clock(RTC) calibration:

1. Enter the **Calibration Menu**

- Press the  button, then use the soft key to select **Utilities > Test/Admin > Security**.

Use the numeric keypad to enter security code. See the subsection Security. Press the  button to enter the security menu.

2. Use the softkeys to select **RTC**.

3. Use the softkey to select **Start**.

4. **Calibration State** will show as **Busy**. The calibration will be adjusted on its own in about 4 to 5 mins.

5. **Calibration State** will show as **Success** once the calibration has finished.

Performance Verification

Performance verification ensures the instrument will meet specifications listed in the datasheet. Load regulation can be tested for both the front and rear outputs.

Note:

All specifications apply to the unit after a temperature stabilization time of 15 minutes over an ambient temperature range of $23\text{ }^{\circ}\text{C} \pm 5\text{ }^{\circ}\text{C}$. Specifications are valid for single unit operation only.

CV Load Regulation Front Panel Output

1. Turn off the power supply before making any connections.
2. Connect the: DMM, electronic load, and the rear panel remote sense to the power supply's terminal being tested. (Remote sense must correspond with the channel being tested.)

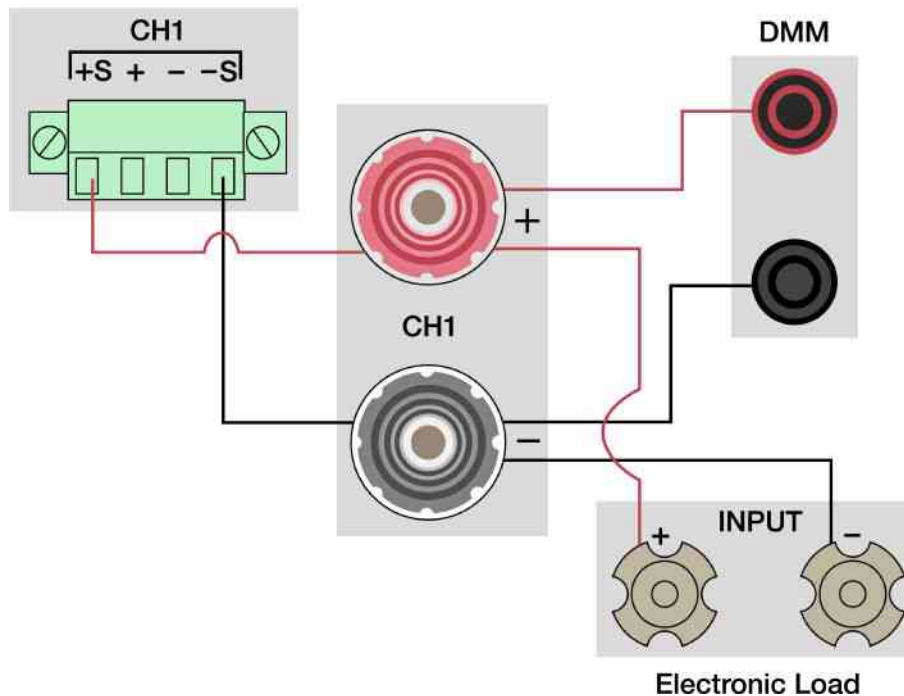

Figure 11.1 Front Panel Wiring Diagram

Note:

Keep all cables as short as possible.

3. Turn on the power supply.
4. Set the power supply settings of the channel being tested to the values given in table 11.1.

5. Set the electronic load settings to the stated values in table [11.1](#).
6. Enable remote sense. See section [Remote Sense](#).
7. Enable the channel output.
8. Enable the electronic load. Monitor the power supply to ensure it remains in CV mode. If the power supply switches to CC slightly lower the current on the electronic load until the power supply return to CV mode.
9. Give the power supply some time to settle and record the DMM reading as V load.
10. Disable the electronic load and record the DMM reading as V no load.
11. Take the difference between V load and V no load ($V_{load} - V_{no\ load}$) and record the value as the voltage regulation. The difference should be within the [specification limit](#).

CV Load Regulation Rear Panel Output

1. Turn off the power supply before making any connections.
2. Connect the: DMM, electronic load, and the rear panel remote sense to the power supply's rear +/- terminal being tested. Use jumpers to connect the +S to + and -S to -. See figure [11.2](#) (Remote sense must correspond with the channel being tested.)

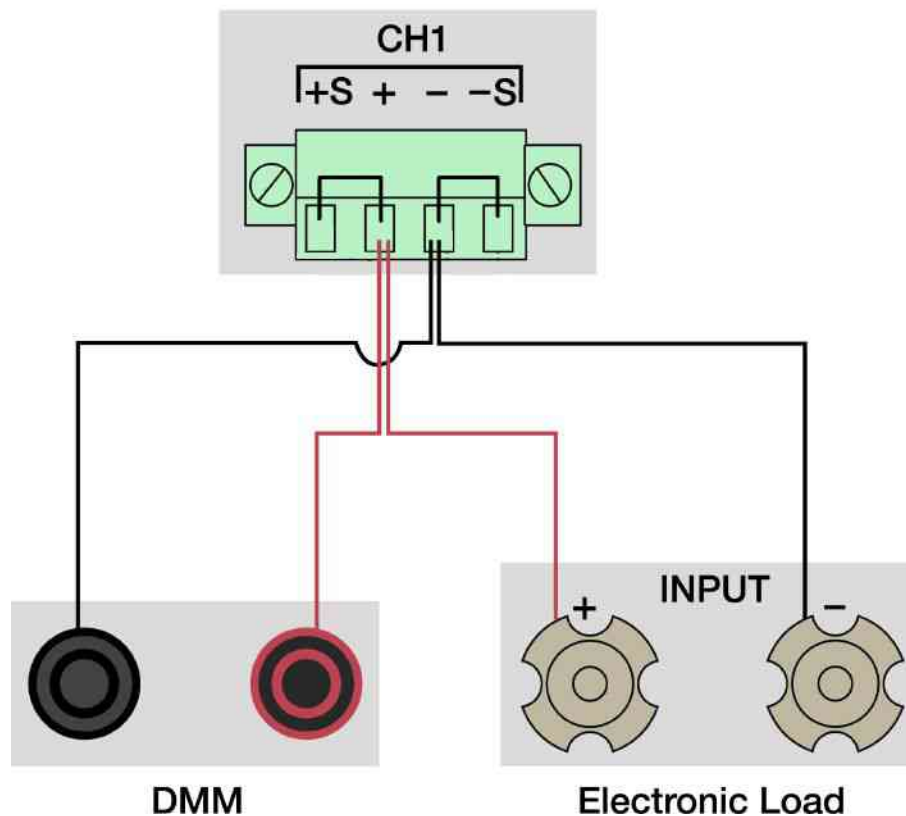

Figure 11.2 Rear Panel Wiring Diagram

3. Turn on the power supply.
4. Set the power supply settings of the channel being tested to the values given in table [11.1](#).
5. Set the electronic load settings to the stated values in table [11.1](#).

6. Enable remote sense. See section **Remote Sense**.
7. Enable the channel output.
8. Enable the electronic load. Monitor the power supply to ensure it remains in CV mode. If the power supply switches to CC slightly lower the current on the electronic load until the power supply return to CV mode.
9. Give the power supply some time to settle and record the DMM reading as V load.
10. Disable the electronic load and record the DMM reading as V no-load.
11. Take the difference between V load and V no-load ($V_{load} - V_{no-load}$) and record the value as the voltage regulation. The difference should be within the **specification limit**.

Model	Power Supply Settings			Electronic Load Settings		Load Regulation Limit	
	Voltage	Current	Remote Sense	Mode	Current	Lower Limit	Upper Limit
9140	32.000 V	3.069 A	Enabled	CC	3.065 A	- 6.2 mV	+ 6.2 mV
9141	60.000 V	1.666 A	Enabled	CC	1.650 A	- 9 mV	+ 9 mV

Table 11.1

Specifications

Note: All specifications apply to the unit after a temperature stabilization time of 15 minutes over an ambient temperature range of 23 °C ± 5 °C. Specifications are valid for single unit operation only.

Model	9140	9141	
Output Rating			
Voltage	32 V	60 V	
Current	8 A	4 A	
Maximum Output Power per Channel	100 W		
Total Output Power	300 W		
Load Regulation ⁽¹⁾ ± (% output + offset)			
Voltage	≤ 0.01% + 3 mV		
Current	≤ 0.1% + 3 mA		
Line Regulation ± (% output + offset)			
Voltage	≤ 0.01% + 3 mV		
Current	≤ 0.1% + 3 mA		
Ripple and Noise (20 Hz to 20 MHz)			
Normal Mode Voltage p-p	≤ 5 mV	≤ 10 mV	
Normal Mode Voltage rms	≤ 1 mV	≤ 2 mV	
Normal Mode Current rms	≤ 3 mA		
Programming / Readback Resolution			
Voltage	1 mV		
Current	1 mA		
Programming / Readback Accuracy ± (% output + offset)			
Voltage	0.03% + 4 mV	0.03% + 8 mV	
Current	0.1% + 5 mA	0.1% + 3 mA	
Series Accuracy (combined mode)			
Voltage	0.03% + 12 mV	0.03% + 24 mV	
Current	0.1% + 5 mA	0.1% + 3 mA	
Parallel Accuracy (combined mode)			
Voltage	0.03% + 4 mV	0.03% + 8 mV	
Current	0.1% + 15 mA	0.1% + 9 mA	
Temperature Coefficient per °C			
Voltage	6.4 mV / °C	12 mV / °C	
Current	1.6 mA / °C	0.8 mA / °C	
Output Response Time ⁽²⁾			
Rise Time	Full load	10 ms	20 ms
	No load	10 ms	20 ms
Fall Time	Full load	10 ms	20 ms
	No load	250 ms	250 ms
Transient Response ⁽³⁾			
Time	0.5 ms		
Protection			
OVP	Range	35.2 V	66 V
	Accuracy	320 mV	600 mV
OCP	Range	8.8 A	4.4 A
	Accuracy	80 mA	40 mA

General		
Remote Sense Compensation	1 V	
Command Response Time ⁽⁴⁾	10 ms	
Power Factor	0.98 / 115 VAC 0.94 / 230 VAC	
I/O Interfaces	USB (USBTMC-compliant and virtual COM), LAN (1.5 LXI device specification 2016), GPIB (optional)	
AC Line Input	100 VAC to 240 VAC ± 10%, 47 Hz to 63 Hz	
Maximum Rated Input Power	500 VA	
Temperature Ratings	Operation	32 °F to 104 °F (0 °C to 40 °C)
	Storage	14 °F to 158 °F (-10 °C to 70 °C)
Dimensions (W x H x D)	8.4" x 3.5" x 13" (213 x 88 x 330 mm)	
Weight	11 lbs (5 kg)	
Warranty	3 Years	
Standard Accessories	Power cord, test report & certificate of calibration	
Optional Accessories	Rack mount kit (RK2US)	

Regulatory Compliance	
Safety	Low Voltage Directive (LVD) 2014/35/EU, EN61010-1:2010, cTUVus certification mark ⁽⁵⁾ fulfills US (UL 61010-1:2012) and Canadian (CAN/CSA-C22.2 NO. 61010-1-12) safety standards
Electromagnetic Compatibility	EMC Directive 2014/30/EU, EN61326-1:2013

- (1) With remote sense terminal connected.
- (2) From 10% to 90% or from 90% to 10% of total voltage excursion.
- (3) Time for output voltage to recover within 0.5% of its rated output for a load change 50-100% of full load.
- (4) Typical time required for output to begin to change following receipt of command data.
- (5) Tested and certified by a Nationally Recognized Testing Laboratory (NRTL), accredited by OSHA.

Ordering Information

9140 Series Power Supplies

Model	Description
9140	32 V / 8 A, 300 W
9140-GPIB	32 V / 8 A, 300 W with GPIB
9141	60 V / 4 A, 300 W
9141-GPIB	60 V / 4 A, 300 W with GPIB

Service Information

Warranty Service: Please go to the support and service section on our website at bkprecision.com to obtain an RMA #. Return the product in the original packaging with proof of purchase to the address below. Clearly state on the RMA the performance problem and return any leads, probes, connectors and accessories that you are using with the device.

Non-Warranty Service: Please go to the support and service section on our website at bkprecision.com to obtain an RMA #. Return the product in the original packaging to the address below. Clearly state on the RMA the performance problem and return any leads, probes, connectors and accessories that you are using with the device. Customers not on an open account must include payment in the form of a money order or credit card. For the most current repair charges please refer to the service and support section on our website. Return all merchandise to B&K Precision Corp. with prepaid shipping. The flat-rate repair charge for Non-Warranty Service does not include return shipping. Return shipping to locations in North America is included for Warranty Service. For overnight shipments and non-North American shipping fees please contact B&K Precision Corp.

Include with the returned instrument your complete return shipping address, contact name, phone number and description of problem.

B&K Precision Corp.
22820 Savi Ranch Parkway
Yorba Linda, CA 92887
bkprecision.com
714-921-9095

LIMITED THREE-YEAR WARRANTY

B&K Precision Corp. warrants to the original purchaser that its products and the component parts thereof, will be free from defects in workmanship and materials for a period of **three years** from date of purchase.

B&K Precision Corp. will, without charge, repair or replace, at its option, defective product or component parts.

Returned product must be accompanied by proof of the purchase date in the form of a sales receipt.

To help us better serve you, please complete the warranty registration for your new instrument via our website
www.bkprecision.com

Exclusions: This warranty does not apply in the event of misuse or abuse of the product or as a result of unauthorized alterations or repairs. The warranty is void if the serial number is altered, defaced or removed.

B&K Precision Corp. shall not be liable for any consequential damages, including without limitation damages resulting from loss of use. Some states do not allow limitations of incidental or consequential damages. So the above limitation or exclusion may not apply to you.

This warranty gives you specific rights and you may have other rights, which vary from state-to-state.

B&K Precision Corp.
22820 Savi Ranch Parkway
Yorba Linda, CA 92887
www.bkprecision.com
714-921-9095