

User Manual

2510B Series

Handheld Digital Storage Oscilloscopes



Safety Summary

The following safety precautions apply to both operating and maintenance personnel and must be followed during all phases of operation, service, and repair of this instrument.

Before applying power to this instrument:

- Read and understand the safety and operational information in this manual.
- Apply all the listed safety precautions.
- Verify that the voltage selector at the line power cord input is set to the correct line voltage. Operating the instrument at an incorrect line voltage will void the warranty.
- Make all connections to the instrument before applying power.
- Do not operate the instrument in ways not specified by this manual or by B&K Precision.

Failure to comply with these precautions or with warnings elsewhere in this manual violates the safety standards of design, manufacture, and intended use of the instrument. B&K Precision assumes no liability for a customer's failure to comply with these requirements.

Category rating

The IEC 61010 standard defines safety category ratings that specify the amount of electrical energy available and the voltage impulses that may occur on electrical conductors associated with these category ratings. The category rating is a Roman numeral of I, II, III, or IV. This rating is also accompanied by a maximum voltage of the circuit to be tested, which defines the voltage impulses expected and required insulation clearances. These categories are:

Category I (CAT I): Measurement instruments whose measurement inputs are not intended to be connected to the mains supply. The voltages in the environment are typically derived from a limited-energy transformer or a battery.

Category II (CAT II): Measurement instruments whose measurement inputs are meant to be connected to the mains supply at a standard wall outlet or similar sources. Example measurement environments are portable tools and household appliances.

Category III (CAT III): Measurement instruments whose measurement inputs are meant to be connected to the mains installation of a building. Examples are measurements inside a building's circuit breaker panel or the wiring of permanently-installed motors.

Category IV (CAT IV): Measurement instruments whose measurement inputs are meant to be connected to the primary power entering a building or other outdoor wiring.

Electrical Power

This instrument is intended to be powered from a CATEGORY II mains power environment. The mains power should be 115 V RMS or 230 V RMS. Use only the power cord supplied with the instrument and ensure it is appropriate for your country of use.

WARNING

Do not use this instrument in an electrical environment with a higher category rating than what is specified in this manual for this instrument.

WARNING

You must ensure that each accessory you use with this instrument has a category rating equal to or higher than the instrument's category rating to maintain the instrument's category rating. Failure to do so will lower the category rating of the measuring system.

Ground the Instrument

WARNING

To minimize shock hazard, the instrument chassis and cabinet must be connected to an electrical safety ground. This instrument is grounded through the ground conductor of the supplied, three-conductor AC line power cable. The power cable must be plugged into an approved three-conductor electrical outlet. The power jack and mating plug of the power cable meet IEC safety standards.

WARNING

Do not alter or defeat the ground connection. Without the safety ground connection, all accessible conductive parts (including control knobs) may provide an electric shock. Failure to use a properly-grounded approved outlet and the recommended three-conductor AC line power cable may result in injury or death.

WARNING

Unless otherwise stated, a ground connection on the instrument's front or rear panel is for a reference of potential only and is not to be used as a safety ground. Do not operate in an explosive or flammable atmosphere.

Environmental Conditions

This instrument is intended to be used in an indoor pollution degree 2 environment. The operating temperature range is 0°C to 40°C and 20% to 80% relative humidity, with no condensation allowed.

Measurements made by this instrument may be outside specifications if the instrument is used in non-office-type environments. Such environments may include rapid temperature or humidity changes, sunlight, vibration and/or mechanical shocks, acoustic noise, electrical noise, strong electric fields, or strong magnetic fields.



Do not operate the instrument in the presence of flammable gases or vapors, fumes, or finely-divided particulates.

The instrument is designed to be used in office-type indoor environments. Do not operate the instrument

- **In the presence of noxious, corrosive, or flammable fumes, gases, vapors, chemicals, or finely-divided particulates.**
 - **In relative humidity conditions outside the instrument's specifications.**
 - **In environments where there is a danger of any liquid being spilled on the instrument or where any liquid can condense on the instrument.**
 - **In air temperatures exceeding the specified operating temperatures.**
 - **In atmospheric pressures outside the specified altitude limits or where the surrounding gas is not air.**
 - **In environments with restricted cooling air flow, even if the air temperatures are within specifications.**
 - **In direct sunlight.**
-



Do not operate instrument if damaged

⚠ WARNING

If the instrument is damaged, appears to be damaged, or if any liquid, chemical, or other material gets on or inside the instrument, remove the instrument's power cord, remove the instrument from service, label it as not to be operated, and return the instrument to B&K Precision for repair. Notify B&K Precision of the nature of any contamination of the instrument.

⚠ WARNING

Hazardous voltages may be present in unexpected locations in circuitry being tested when a fault condition in the circuit exists.

Clean the instrument only as instructed

⚠ WARNING

Do not clean the instrument, its switches, or its terminals with contact cleaners, abrasives, lubricants, solvents, acids/bases, or other such chemicals. Clean the instrument only with a clean dry lint-free cloth or as instructed in this manual. Not for critical applications

Do not touch live circuits

Instrument covers must not be removed by operating personnel. Component replacement and internal adjustments must be made by qualified service-trained maintenance personnel who are aware of the hazards involved when the instrument's covers and shields are removed. Under certain conditions, even with the power cord removed, dangerous voltages may exist when the covers are removed.

WARNING

To avoid injuries, always disconnect the power cord from the instrument, disconnect all other connections (for example, test leads, computer interface cables, etc.), discharge all circuits, and verify there are no hazardous voltages present on any conductors by measurements with a properly-operating voltage-sensing device before touching any internal parts. Verify the voltage-sensing device is working properly before and after making the measurements by testing with known-operating voltage sources and test for both DC and AC voltages.

Do not attempt any service or adjustment unless another person capable of rendering first aid and resuscitation is present.

General Safety

WARNING

Do not insert any object into an instrument's ventilation openings or other openings.

WARNING

This instrument is not authorized for use in contact with the human body or for use as a component in a life-support device or system.

Servicing

WARNING

Do not substitute parts that are not approved by B&K Precision or modify this instrument. Return the instrument to B&K Precision for service and repair to ensure that safety and performance features are maintained.

WARNING

Fuse replacement must be done by qualified service-trained maintenance personnel who are aware of the instrument's fuse requirements and safe replacement procedures. Disconnect the instrument from the power line before replacing fuses. Replace fuses only with new fuses of the fuse types, voltage ratings, and current ratings specified in this manual or on the back of the instrument. Failure to do so may damage the instrument, lead to a safety hazard, or cause a fire. Failure to use the specified fuses will void the warranty.

For continued safe use of the instrument

- Do not place heavy objects on the instrument.
- Do not obstruct cooling air flow to the instrument.
- Do not place a hot soldering iron on the instrument.
- Do not pull the instrument with the power cord, connected probe, or connected test lead.
- Do not move the instrument when a probe is connected to a circuit being tested.

Compliance Statements

Disposal of Old Electrical & Electronic Equipment (Applicable in the European Union and other European countries with separate collection systems)



This product is subject to Directive 2002/96/EC of the European Parliament and the Council of the European Union on waste electrical and electronic equipment (WEEE), and in jurisdictions adopting that Directive, is marked as being put on the market after August 13, 2005, and should not be disposed of as unsorted municipal waste. Please utilize your local WEEE collection facilities in the disposition of this product and otherwise observe all applicable requirements.



Safety Symbols











Symbol	Description
	Indicates a hazardous situation which, if not avoided, could result in death or serious injury.
	Indicates a hazardous situation which, if not avoided, will result in minor or moderate injury.
	Refer to the text near the symbol.
	Electric Shock hazard
	Alternating current (AC)
	Chassis ground
	Earth ground
	Indicates the In position of the power switch when instrument is ON.
	Indicates the Out position of the power switch when instrument is OFF.
	Indicates practices not related to physical injury.

Table 1 Safety Symbols

Contents

1	Introduction	14
1.1	Product Overview	14
1.2	Contents	15
1.3	Features	15
1.4	Dimensions & Weight	16
1.5	Front Panel	17
1.6	Horizontal Scale and Position	19
1.7	Vertical Scale and Position	20
1.8	Trigger	21
1.9	Single Function Buttons	21
1.10	Dual Function Buttons	23
1.11	Universal Knob	25
2	Horizontal System	26
2.1	Horizontal Scale and Position	26
2.2	Roll Mode	27
2.3	Zoom Mode	28
3	Vertical System	29
3.1	Channels	29
3.2	Coupling	30
3.3	Bandwidth Limit	31
3.4	Adjust Scale	32
3.5	Probe Attenuation	33
3.6	Unit	34
3.7	Deskew	34
3.8	Invert	35
3.9	Offset	35
3.10	Trace	36
4	Acquisition System	37
4.1	Acquisition Mode	38
4.2	Sampling Overview	43
4.3	Bandwidth and Sample Rate	44
4.4	Memory Depth	45
4.5	Sampling Mode	46
4.6	Interpolation Method	46
4.7	XY Time Mode	49
4.8	Sequence Mode	51

5	Trigger	52
5.1	Trigger Source	53
5.2	Trigger Mode	54
5.3	Trigger Level	56
5.4	Trigger Coupling	57
5.5	Trigger Holdoff	59
5.6	Noise Rejection	60
5.7	Trigger Type	61
5.7.1	Set Trigger Type	61
6	Serial Trigger and Decode	80
6.1	I2C Trigger and Serial Decode	81
6.1.1	I2C Setup	81
6.1.2	I2C Trigger Conditions	83
6.1.3	I2C Trigger Configuration	86
6.1.4	I2C Serial Decode	87
6.1.5	Interpreting I2C Decode	88
6.2	SPI Trigger and Serial Decode	89
6.2.1	SPI Setup	89
6.2.2	SPI Trigger	91
6.2.3	SPI Serial Decode	92
6.2.4	Interpreting SPI Decode	93
6.3	UART Trigger and Serial Decode	94
6.3.1	UART Setup	94
6.3.2	UART Trigger	96
6.3.3	UART Serial Decode	97
6.3.4	Interpreting UART Decode	98
6.4	CAN Trigger and Serial Decode	99
6.4.1	CAN Setup	99
6.4.2	CAN Trigger	100
6.4.3	CAN Serial Decode	101
6.5	LIN Trigger and Serial Decode	103
6.5.1	LIN Setup	103
6.5.2	LIN Trigger	104
6.5.3	CAN Serial Decode	105
7	Reference Waveform	107
7.1	Saving a Reference	108
7.2	Display a Reference Waveform	109
7.3	Adjust Reference Waveform	109
7.4	Clear Reference Waveform	110
8	Math	111
8.1	Selecting a Math Function	112

8.2	Add or Subtract	112
8.3	Multiply or Divide	113
8.4	Differentiate	113
8.5	Integrate	114
8.6	Square Root	114
8.7	FFT Operation	115
9	Cursors	122
9.1	X Cursors	122
9.2	Y Cursors	122
9.3	Cursor Measurements	123
10	Measure	124
10.1	Type of Measurements	125
10.1.1	Voltage Measurements	126
10.1.2	Time Measurements	128
10.1.3	Delay Measurements	129
10.2	Add a Measurement	130
10.3	Clear Measurement	131
10.4	All Measurement	131
10.5	Gate Measurement	132
11	Display	133
11.1	Display Type	134
11.2	Color Grade	135
11.3	Persistence	136
11.4	Clear Display	136
11.5	Grid Type	137
11.6	Intensity	137
11.7	Transparence	138
11.8	LCD Light	138
12	Save and Recall	139
12.1	Save Types	139
12.2	Save and Recall a File	141
12.3	Save File	141
12.4	Recall File	142
12.5	File Manager	143
12.5.1	Create a New File or Folder	143
12.5.2	Delete a File or Folder	144
12.5.3	Rename a File or Folder	144
12.5.4	Copy a File or Folder	144
12.5.5	Cut a File or Folder	145

13	System Settings	146
13.1	View System Status	147
13.2	Self Cal	148
13.3	Quick-Cal	149
13.4	Sound	149
13.5	Language	149
13.6	Update Firmware and Configuration	150
13.6.1	Update Firmware	150
13.6.2	Update Configure	151
13.7	Self Test	152
13.7.1	Screen Test	152
13.7.2	Keyboard Test	153
13.7.3	LED Test	154
13.8	Screen Saver	155
13.9	Date and Time	155
13.9.1	Set Date	155
13.9.2	Set Time	156
13.9.3	Set Zone	156
13.10	Reference Position	157
14	Search	158
14.1	Settings	159
15	Navigate	160
15.1	Navigating the Time Base	160
15.2	History Frame Navigate	161
15.3	Search Event Navigate	161
16	History	162
17	Meter	164
17.1	Meter Front Panel	165
17.2	DCV/ACV	166
17.3	Resistance	167
17.4	Diode	168
17.5	Continuity	169
17.6	Capacitance	170
17.7	DCI/ACI	171
18	Smample Logger	172
18.1	Sample Logger Interface	173
18.2	Record	174
18.2.1	Record Settings	174
18.2.2	Recall Recorded Waveform	175
18.2.3	Display Control	175

19	Measure Logger	176
19.1	Measure Logger Settings	178
19.1.1	Log Interval	178
19.1.2	Select Trace and Measure Item	178
19.2	Start/Stop Recording	178
19.3	Display Control	179
19.3.1	Vertical Scale	179
19.3.2	Horizontal	179
19.3.3	Display	180
19.3.4	Cursors	180
19.4	Save/Recall	182
20	Service Information	183
21	LIMITED THREE-YEAR WARRANTY	184

Introduction

1.1 Product Overview

The 2510B Series handheld digital storage oscilloscopes provide floating measurement and recorder capabilities with a built-in digital multimeter (DMM), all in one portable and lightweight package.

These versatile scopes provide two analog channels with a maximum bandwidth of 200 MHz and maximum sample rate of 1 GSa/s. Their 12 Mpts. memory depth, 100,000 wfms/s update rate and 5.6" TFT-LCD can capture transient and long-term signal behavior with excellent fidelity.



Figure 1.1 2510B

1.2 Contents

Please inspect the instrument mechanically and electrically upon receiving it. Unpack all items from the shipping carton, and check for any obvious signs of physical damage that may have occurred during transportation. Report any damage to the shipping agent immediately. Save the original packing carton for possible future reshipment. Every power supply is shipped with the following contents:

- 1 x 2510B or 2511B
- Charger
- 2 x Probes (PR250SA or PR250B based on model number)
- 1 x FS064 and FS10A
- 1 x Certificate of Calibration

NOTICE

Ensure the presence of all the items above.
Contact the distributor or B&K Precision if anything is missing.

1.3 Features

- 100 MHz and 200 MHz bandwidth
- Maximum sample rate of 1 GSa/s
- Dual scope channels with 1,000 V CAT II,
- 600 V CAT III ratings (isolated models 2515 and 2516)
- 300 V CAT II rated inputs (nonisolated models 2511 and 2512)
- Built-in 6000-count DMM
- Scope and meter trend plot functions for data logging
- FFT including four additional math functions - Add, Subtract, Multiply, and Divide
- 32 automatic measurements
- Front panel USB host port for saving and recalling waveform setups, data, and screenshots on a USB flash drive
- Advanced tools include digital filters with adjustable limits, scope recorder, and waveform recorder mode

1.4 Dimensions & Weight

Dimensions

The 2510B Series dimensions are approximately:
6.61" x 10.87" x 2.68" (168 x 276 x 68 mm) (W x H x D)



Figure 1.2 Dimensions

Weight

NOTICE

Without package: 3.86 lbs. (1.75 kg);
With package: 7.72 lbs. (3.5 kg)

1.5 Front Panel



Figure 1.3 Front Panel

Item	Name	Description
1	Power Switch	Press to toggle the instrument on/off.
2	Horizontal Control	Adjust the horizontal position and time base. See section 1.6
3	Vertical Control	Adjust the vertical position and time base. See section 1.7
4	Trigger Control	Sets the trigger conditions for data acquisition. See section 1.8
5	Dual Function Buttons	See section 1.10 for more information.
6	Softkeys	Invoke the function displayed above the softkey.
7	Display	5.6-inch TFT LCD color display.
8	Analog Channel Input	Two analog input channels with default 1 M Ω resistance.
9	Universal Knob	Navigates menus and modifies parameters.
10	Single Function Buttons	See section 1.9 for more information.
11	Multimeter Input	Multimeter input terminals for meter function. Dedicated terminals are provided for current measurements.

Table 1.1 Front Panel

1.6 Horizontal Scale and Position



Figure 1.4 Horizontal Control and Channel Control

Horizontal Scale Buttons



Press the **Horizontal Scale** buttons to adjust the horizontal time base (time/div).

To reduce the time base press the **ns** button.

To increase the time base press the **s** button.

Horizontal Position Buttons



Press the **Horizontal Position** buttons to adjust the horizontal position (delay). The waveforms of both channels will move horizontally with the trigger point.

To reduce the delay press the **>** button.

To increase the delay press the **<** button.

Pressing the **shift + horizontal scale** buttons resets the horizontal delay to zero.

1.7 Vertical Scale and Position



Figure 1.5 Vertical Control

Channels

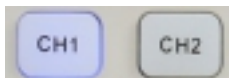

Enable/disable the corresponding channel. The two channels are marked by different colors which are also used to mark the corresponding waveforms on the screen.

Vertical Position Button



Adjust the vertical position (offset) of selected channel's waveform. Press **V** to increase the offset and **mV** to decrease it. During modification, the position is shown in the center of the display.

Pressing the **shift + vertical scale** buttons resets the vertical offset to zero.

Vertical Scale Button



Adjust the vertical scale of the selected channel. Press **V** to increase the scale and **mV** to decrease the scale.

During modification, the amplitude of the waveform is enlarged or reduced and the scale information in left bottom corner of the display is updated.

1.8 Trigger

Trigger Setup

A dark grey rounded rectangular button with the text "Trigger Setup" in white.

Calls the **Trigger Configuration** menu. For more information about the trigger parameters see **chapter 1.8**.

Trigger Level

A light grey rounded rectangular button with the text "Trigger Level" in dark grey.

Enables trigger level configuration function for the Universal knob. Upon pressing the **Trigger Level** button the **Universal Knob** can be used to increase/decrease the trigger level.

During modification the trigger value is displayed in the center lower portion of the display.

Press down the **Universal Knob button** to reset the trigger level to 0 V.

1.9 Single Function Buttons

Acquire Button

A dark grey rounded rectangular button with the text "Acquire" in white.

Calls the **Acquire** menu. For more information see chapter ???. Pressing the **Display/Persist** button while in the **Display** menu toggles the **Persist** function.

Display/Persist

A dark grey rounded rectangular button with the text "Display" on the top line and "Persist" on the bottom line, both in white.

Calls the **Display** menu. For more information see **chapter 11**

Utility



Calls the System menu. For more information see [chapter 13](#)

Run/Stop



Toggles the data acquisition state. The button is white when the oscilloscope is acquiring. When the button is red, data acquisition is stopped. To start acquisition, press the **Run/Stop** button.

To capture and display a single acquisition (whether the oscilloscope is running or stopped), set **Trigger Mode** to **Single**.

Auto Setup



Pressing the **Auto Setup** button causes the oscilloscope to determine which channels have activity, and scales them to automatically configure the input to best display the input signals.

Default



Restores the oscilloscope's default settings.

1.10 Dual Function Buttons

The **Dual Function** buttons have two dedicated function. The first function is printed on the button. To call this function simply press the button. The second function is printed above the button in **blue**. To call the second function of the button press the **Shift** + button.

Shift

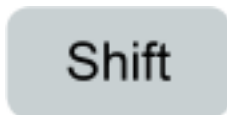

While the **Shift** button does not have a secondary function it is placed in the dual function section since it is required to call the second function of the dual function buttons.

Pressing the **Shift** buttons switches the function of the dual function buttons.

Scope/Search

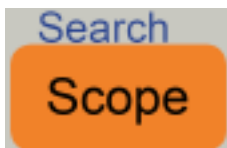

Primary Function: Press the **Scope** button to enter Scope mode.

Secondary Function: Press **Shift** then **Scope** to enter the **Search** function menu.

Meter/History



Primary Function: Press the **Meter** button to enter **Meter** mode.

Secondary Function: Press **Shift** then **Meter** to enter the **History** mode. In his story mode, the scope can record most 80,000 frames waveforms.

Recorder/Navigate

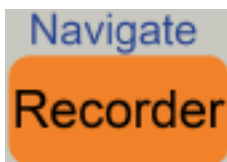

Primary Function: Press the **Recorder** button to enter **Recorder** mode.

Secondary Function: Press **Shift** then **Recorder** to toggle the **Navigate** function.

Measure/Math

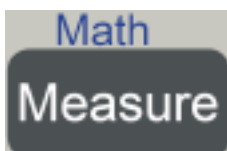

Primary Function: Press the **Measure** button to toggle **Measurements**.

Secondary Function: Press **Shift** then **Measure** to toggle the **Math** function.

Cursors/Save/Recall

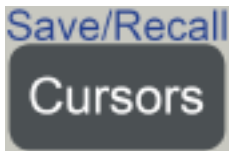

Primary Function: Press the **Cursors** button to toggle **Cursor** mode.

Secondary Function: Press **Shift** then **Cursors** to enter the **Save/Recall** function menu.

Print / Decode

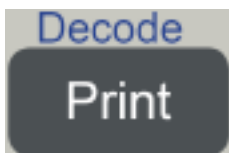

Primary Function: Press the **Print** button to perform a screenshot save to an external storage device.

Screenshots can be saved in the following formats: .bmp | .jpg | .png.

Secondary Function: Press **Shift** then **Decode** to enter the **Decode** function menu.

The oscilloscope supports I2C, SPI, UART, CAN and LIN serial bus decode.

Menu/Ref



Primary Function: Press the **Menu** button to toggle the **menu** display.

Secondary Function: Press **Shift** then **Menu** to enter the **REF** function menu.

Clear Sweeps/Zoom



Primary Function: Press the **Clear Sweeps** button to clear the data and the display in multiple sweeps.

This includes the display persistence, measurement statistics, average sweeps and Pass/Fail statistics.

Secondary Function: Press **Shift** then **Clear Sweeps** to enter the **Zoom** function mode.

1.11 Universal Knob



Figure 1.6 Universal Knob

Modify Parameters

. After having chosen a parameter the **Adjust** LED will be enabled, indicating the universal knob can be used to configured the selected parameter.

Turn the **Universal Knob** to modify the value. Push the center button of the knob to confirm the current submenu.

Turn clockwise to increase and counterclockwise to reduce the value. In addition, it can also be used to adjust scale and offset of **MATH** and **REF**.

Select the Desired Submenu

In menu operation, press any menu softkey and turn the **Universal Knob** to select the desired submenu under. Push the center button of the knob to confirm the current submenu.

Choose File or Directory

After having entered the file system, turn the **Universal Knob** to select the desired file or directory. When inputting filename, turn the **Universal Knob** to select the desired character and the push the knob to confirm.

Horizontal System

This chapter introduces how to configure the vertical parameters of the oscilloscope. The 2510B series provides two analog input channels. Each channel shares the same vertical control system. Therefore, channel 1 will be used as an example for this chapter to introduce the parameters of the vertical system.

The contents of this chapter include:

2.1	Horizontal Scale and Position	26
2.2	Roll Mode	27
2.3	Zoom Mode	28

2.1 Horizontal Scale and Position

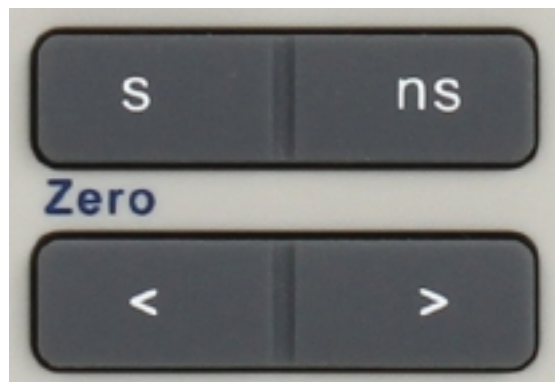

Figure 2.1

Horizontal Scale Buttons

Press the **Horizontal Scale** buttons to adjust the horizontal time base (time/div).

To reduce the time base press the **ns** button.

To increase the time base press the **s** button.

Horizontal Position Buttons

Press the **Horizontal Position** buttons to adjust the horizontal position (delay). The waveforms of both channels will move horizontally with the trigger point.

To reduce the delay press the < button.

To increase the delay press the > button.

Pressing the **shift** + **horizontal position** buttons resets the horizontal delay to zero.

2.2 Roll Mode

In **Roll** mode the waveform moves slowly across the screen from right to left. It only operates on the time bases settings of 50 ms/div or slower. If the current time base settings are faster than the 50 ms/div limit, it will be set to 50 ms/div when **Roll** mode is entered.

To enable the **Roll** mode:

1. Press the Acquire.
2. Press the **F5** soft key to enter the second page of the acquire menu.
3. Press the **F3** soft key to enable/disable **Roll** mode.

In Roll mode there is no trigger. The fixed reference point on the screen is the right edge of the screen and refers to the current moment in time. Events that have occurred are scrolled to the left of the reference point. Since there is no trigger, no pre-trigger information is available.

To pause the display in Roll mode press the **Run/Stop** button. To clear the display or restart an acquisition in Roll mode, press the **Run/Stop** button again.

Use Roll mode on low-frequency waveforms to yield a display much like a strip chart recorder. It allows the waveform to roll across the display.

2.3 Zoom Mode

Zoom is a horizontally expanded version of the normal display. You can use Zoom to locate and horizontally expand part of the normal window for a more detailed (higher- resolution) analysis of signals.

Press the **Shift** button then press the Clear Sweep button to enable the **Zoom** function. To disable the **Zoom** function press the combination buttons again. When Zoom function is on, the display window split in half. The top half shows the main window and the bottom half displays a faster zoom window.

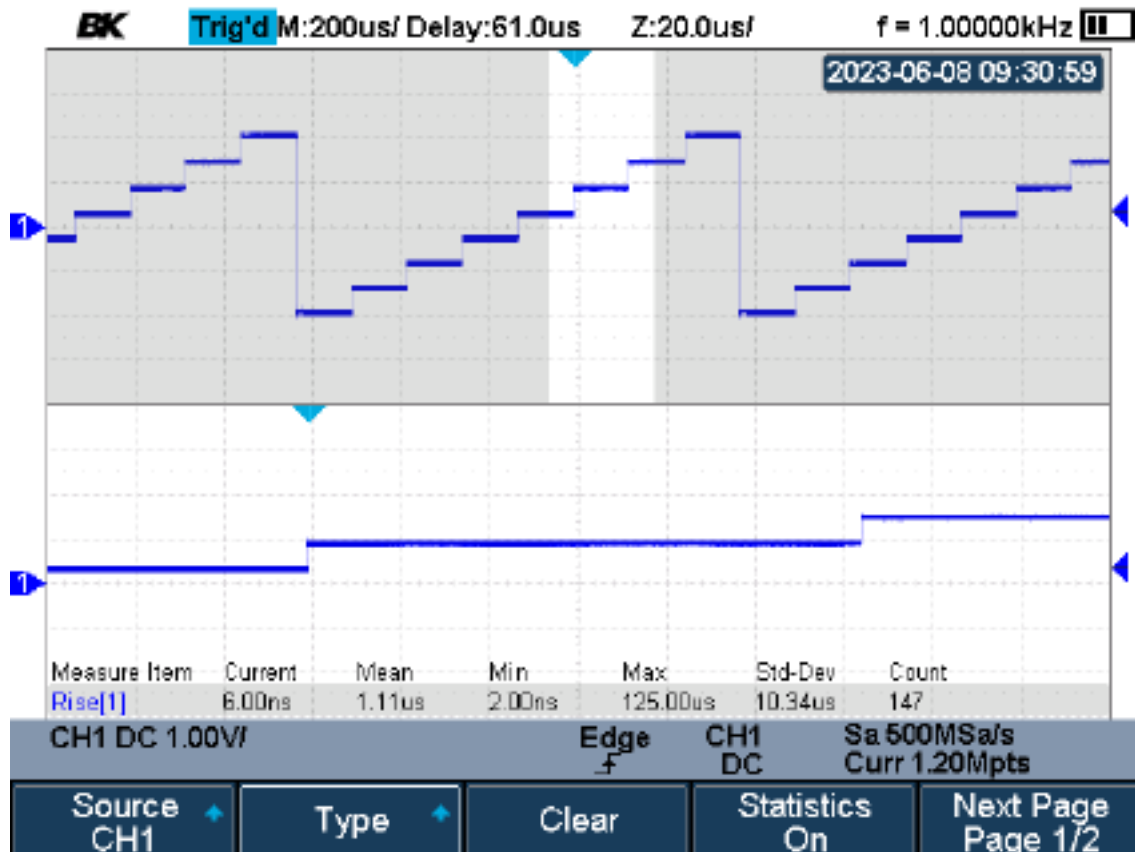

Figure 2.2 Zoom Mode

The extended normal window area is outlined with a border, and the rest of the normal window is ghosting. This border area in the normal window is zoomed to the lower half.

To change the time base for the Zoom window, press the Horizontal Scale button. The Horizontal Scale button controls the size of the border area.

The Horizontal Position button sets the left- to- right position of the zoom window. The delay value, which is the time displayed relative to the trigger point is momentarily displayed in the upper- right corner of the display when pressing the Horizontal Position button.

Negative delay values indicate you're looking at a portion of the waveform before the trigger event, and positive values indicate you're looking at the waveform after the trigger event.

To change the time base of the normal window, turn off Zoom; then press the Horizontal Scale button.

Vertical System

This chapter introduces how to configure the vertical parameters of the oscilloscope. The 2510B series provides two analog input channels. Each channel shares the same vertical control system. Therefore, channel 1 will be used as an example for this chapter to introduce the parameters of the vertical system.

NOTICE

We recommend always scaling the signal so that the entire waveform is contained between the top and bottom of the display.

The contents of this chapter include:

3.1	Channels	29
3.2	Coupling	30
3.3	Bandwidth Limit	31
3.4	Adjust Scale	32
3.5	Probe Attenuation	33
3.6	Unit	34
3.7	Deskew	34
3.8	Invert	35
3.9	Offset	35
3.10	Trace	36

3.1 Channels

Pressing the **Channels** keys in the vertical control area will enable the selected channel.

After enabling a channel the channel's setting menu and the channel information bar will be displayed at the bottom of the screen. Modify the parameters available according to the input signal to make the waveform display easy to observe and measure.

NOTICE

To turn off the channel, press the channel button twice.

To turn off the channel, press the channel button twice.

3.2 Coupling

Coupling sets the mode to filter out the undesired signals. There is 3 coupling modes available: **AC** (alternating current), **DC** (direct current), and **GND** (ground).

NOTICE

Channel Coupling is independent of **Trigger Coupling**. To change trigger coupling see **Trigger Coupling**.

To select a coupling mode:

1. Press the **CH1** button.
2. Press the **F1** soft key to select **Coupling**.
 - The coupling drop-down menu will appear.
3. Use the **Universal Knob** to select the desired coupling mode.
 - Pressing the **Coupling** soft key continuously also toggles between the coupling mode.

NOTICE

The current coupling mode is displayed in the channel information bar at the bottom of the screen.

DC (Direct Current)

Both the DC and AC components of the signal under test can both pass through the channel. DC coupling is useful for viewing waveforms as low as 0 Hz that do not have large DC offsets.

AC (Alternating Current)

The signal is capacitively coupled. DC signal components are rejected. See the datasheet for details of the cut-off frequency. AC coupling is suitable for observing AC signals with DC offset, such as power ripple.

AC coupling is useful for viewing waveforms with large DC offsets.

AC coupling places a 10 Hz high-pass filter in series with the input waveform that removes any DC offset voltage from the waveform.

NOTICE

If the channel is AC coupled, the DC component of the signal is removed, allowing for greater sensitivity to display the AC component of the signal.

GND (Ground)

The channel is grounded by an internal switch. GND coupling is used to observe the zero offset error of the analog channels or determine the source of noise in the waveform (from signal or from oscilloscope itself).

3.3 Bandwidth Limit

Sets the bandwidth limit to reduce display noise. The bandwidth can be limited to 20 MHz. When the bandwidth is limited to **20M**, the high frequency components that exceed 20 MHz will be attenuated.

If bandwidth limit is set to **Full** the high frequency components of the signal under test can pass through the channel.

To toggle the bandwidth limit between **Full** and **20M**:

1. Press the **CH1** button.
2. Press the **F2** soft key.

NOTICE

When the bandwidth limit is enabled, the character **B** will be displayed in the channel information bar at the bottom of the screen.

3.4 Adjust Scale

The vertical scale changes the vertical sensitivity(gain) for the selected channel. This sensitivity can be adjusted in either **Fine** or **Coarse** mode.

To toggle between **Fine** and **Coarse**:

1. Press the **CH1** button.
2. Press the **F3** soft key to toggle between the adjustment modes.
 - Once the desired adjustment mode is selected press the Vertical Scale to increase(**V**) or decrease(**mV**) the scale.

Fine Adjustment

Adjust the vertical scale within a relatively smaller range to improve vertical resolution.

Use fine adjustment to improve the amplitude of waveform display to view signal details when the amplitude of the input waveform is a bit greater than the full scale under the current scale and the amplitude would be lower if the next scale is used.

NOTICE

Coarse Adjustment

Adjust the vertical scale in a 1-2-5 step namely 2 mV/div, 5 mV/div, 10 mV/div ...100 V/div.

The scale information in the channel information bar at the bottom of the screen will change accordingly during the adjustment process. The adjustable range of the vertical scale is related to the probing ratio currently set. By default, the probe attenuation factor is 1X and the adjustable range of the vertical scale is from 2 mV/div to 100 V/div.

3.5 Probe Attenuation

Set the probe attenuation factor to match the type of the probe being used to ensure correct vertical readouts.

To configure a custom attenuation factor:

To change the probe attenuation:

1. Press the **CH1** button.
2. Press the **F4** soft key.
3. Press the **F1** soft key.
 - The probe attenuation drop-down menu will appear.
4. Use the **Universal Knob** to select the desired coupling mode.
 - Pressing the **Coupling** soft key continuously also toggles between the coupling mode.

Setting	Attenuation Factor
0.1 X	0.1 : 1
0.2 X	0.2 : 1
0.5 X	0.5 : 1
1 X	1 : 1
2 X	2 : 1
...	...
5000 X	5000 : 1
10000X	10000 : 1
Custom	1000000 ~ 0.000001:1

Table 3.1 Attenuation Settings

Four custom attenuation factors can be configured.

1. Press the **CH1** button.
2. Press the **F4** soft key.
3. Press the **F1** soft key.
 - The probe attenuation drop-down menu will appear.
4. Select one of the four custom attenuation settings. (**Custom A- D**)
 - Custom will now be available under the **F2** soft key.
5. Press the **F2** soft key to toggle between **Custom** and **Custom Fine**.
6. Use the **Universal Knob** to modify the attenuation factor.
 - Pressing enter button will call the numeric keypad.
 - Use the **Universal Knob** to navigate the numeric keypad.

3.6 Unit

Sets the amplitude display unit for the selected channel. The available units are **V** (voltage) and **A** (current). When the unit is changed, the unit displayed in the channel information bar will change accordingly.

To change the unit:

1. Press the **CH1** button.
2. Press the **F5** soft key to enter the second page of the CH1 function menu.
3. Press the **F1** soft key to toggle between **V** and **A**.

NOTICE

The default setup is **V**.

3.7 Deskew

When measuring time intervals in the nanoseconds (ns) range, small differences in cable length can affect the measurement. Use Deskew to remove cable-delay errors between any two channels.

For example, two coaxial cables with a 1-inch difference in length could introduce a skew of more than 100 ps. In some scenarios (e.g. measuring the setup/hold time between clock and data), it may be necessary to compensate the skew between channels.

The method of compensation: Probe the same signal simultaneously using two channels (including the cables or probes that you intend to use for measurements) and adjust the deskew parameter of one channel until the waveforms of the two channels observed on the screen coincide horizontal

To set **Deskew**:

1. Press the **CH1** button.
2. Press the **F5** soft key to enter the second page of the CH1 function menu.
3. Press the **F2** soft key.
4. Use the **Universal Knob** to set the deskew value.
 - Pressing enter button will call the numeric keypad.
 - Use the **Universal Knob** to navigate the numeric keypad.

3.8 Invert

When Invert is enabled, the waveform is displayed 180 degrees opposite to the earth potential. This is a mathematical inversion and does not physically change the actual potential of the input signal. Inverting a channel also changes the result of any math function selected and measure function.

To invert the channel:

1. Press the **CH1** button.
2. Press the **F5** soft key to enter the second page of the CH1 function menu.
3. Press the **F3** soft key to enable/disable the invert function.

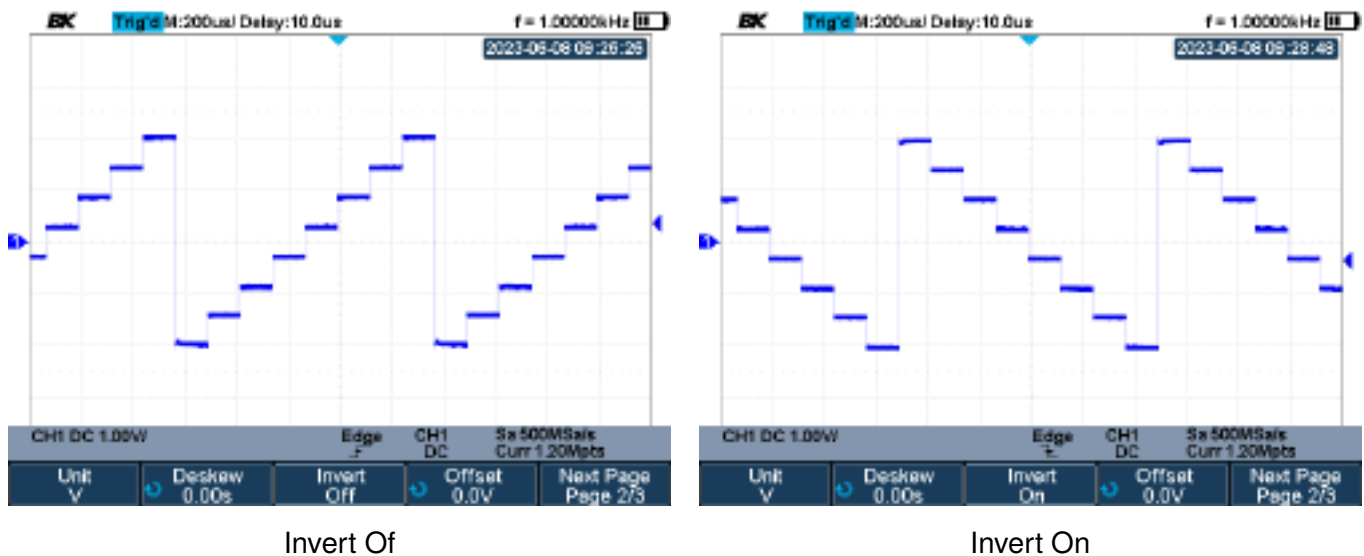

Figure 3.1 Invert

3.9 Offset

Adjust the vertical position (offset). This offers the same function as the **Vertical Position** button with more precision through the use of the numeric keypad.

To set the offset:

1. Press the **CH1** button.
2. Press the **F5** soft key to enter the second page of the CH1 function menu.
3. Press the **F4** soft key to select the offset function.
4. Use the **Universal Knob** to set the deskew value.
 - Pressing enter button will call the numeric keypad.
 - Use the **Universal Knob** to navigate the numeric keypad.

3.10 Trace

When Visible is selected, the waveform is displayed. When Hidden is selected, the waveform is not displayed, but the channel is still active.

To enable/disable trace:

1. Press the **CH1** button.
2. Press the **F5** soft key to enter the second page of the CH1 function menu.
3. Press the **F5** soft key to enter the third page of the CH1 function menu.
4. Press the **F1** soft key to enable/disable trace.

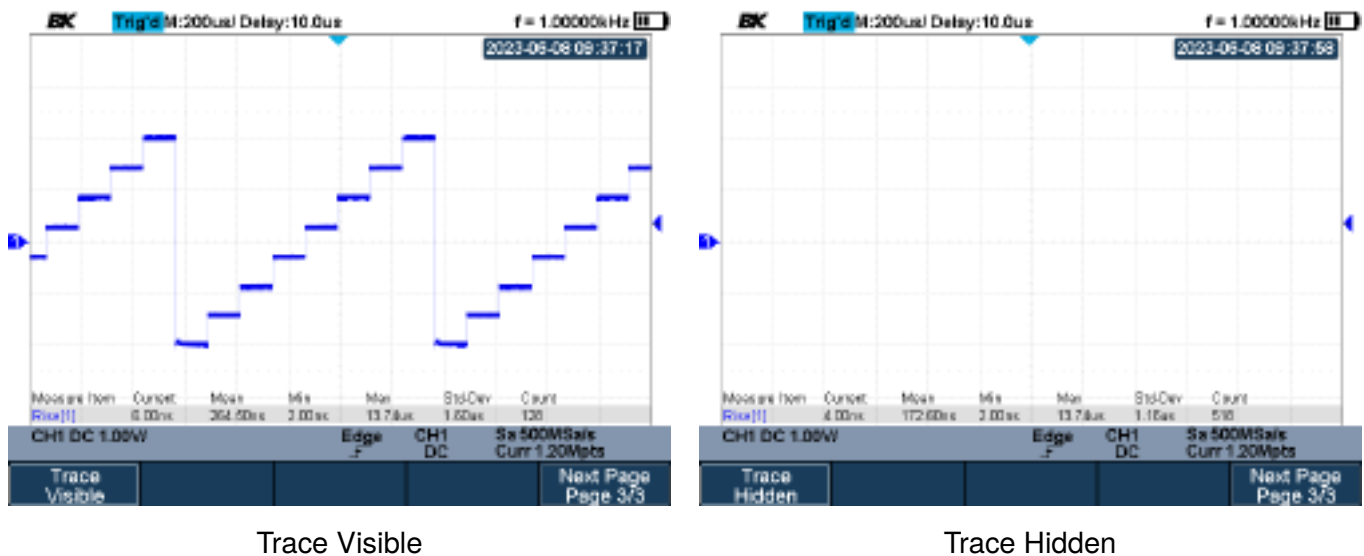

Figure 3.2 Invert

Acquisition System

This chapter introduces how to use the acquisition control and set the sampling system of the oscilloscope.

4.1	Acquisition Mode	38
4.2	Sampling Overview	43
4.3	Bandwidth and Sample Rate	44
4.4	Memory Depth	45
4.5	Sampling Mode	46
4.6	Interpolation Method	46
4.7	XY Time Mode	49
4.8	Sequence Mode	51

When selecting the oscilloscope's acquisition mode, keep in mind that samples are normally reduced at slower time/div settings.

At slower time/div settings, the effective sample rate drops, and the effective sample period increases. This occurs because the acquisition time increases and the oscilloscope's digitizer is sampling faster than it is required to fill memory.

For example, suppose an oscilloscope's digitizer has a sample period of 1 ns (maximum sample rate of 1 GSa/s) and a 1 M memory depth. At that rate, memory is filled in 1 ms. If the acquisition time is 100 ms (10 ms/div), only 1 of every 100 samples is needed to fill memory.

4.1 Acquisition Mode

The acquisition mode is used to control how to generate waveform points from sample points.

Modes	Description
Normal Acquisition	At slower time/div settings, normal decimation occurs, and there is no averaging. Use this mode for most waveforms.
Peak Detect Acquisition	At slower time/div settings when decimation would normally occur, the maximum and minimum samples in the effective sample period are stored. Use this mode for displaying narrow pulses that occur infrequently.
Average Acquisition	At all time/div settings, the specified number of triggers are averaged together. Use this mode for reducing noise and increasing resolution of periodic signals without bandwidth or rise time degradation.
ERES Acquisition	At all time/div settings, the specified number of triggers are averaged together. Use this mode when the sample rate of the digital converter is higher than the storage rate of the acquisition memory.

Table 4.1 Acquisition Modes

To select the acquisition mode:

1. Press the **Acquire** button.
2. Press the **F1** button to select **Acquisition**.
 - A dropdown menu containing the available options (refer to [table 4.1](#)) will appear.
3. Use the **Universal Knob** to navigate the available options.
 - Repeatedly pressing the **F1** will also navigate through the available choices.

Normal Acquisition

The **Normal Acquisition** function of an oscilloscope is the default mode of operation that provides a real-time display of the input signal's waveform. It is designed to capture and display signals in their natural form, allowing users to observe and analyze their characteristics. For most of the waveforms, the best display effect can be obtained using this mode

In normal acquisition mode, the oscilloscope continuously samples the input signal at a predetermined sampling rate and displays the acquired data on its screen. The sampling rate determines how frequently the oscilloscope captures the voltage values of the signal, ensuring that the displayed waveform is an accurate representation of the input signal.

This mode is particularly useful for observing periodic or repetitive signals, as it provides a stable and continuous display of the waveform. It allows users to measure parameters such as amplitude, frequency, and time duration of the signal, making it an essential tool for various applications, including circuit analysis, signal troubleshooting, and system debugging.

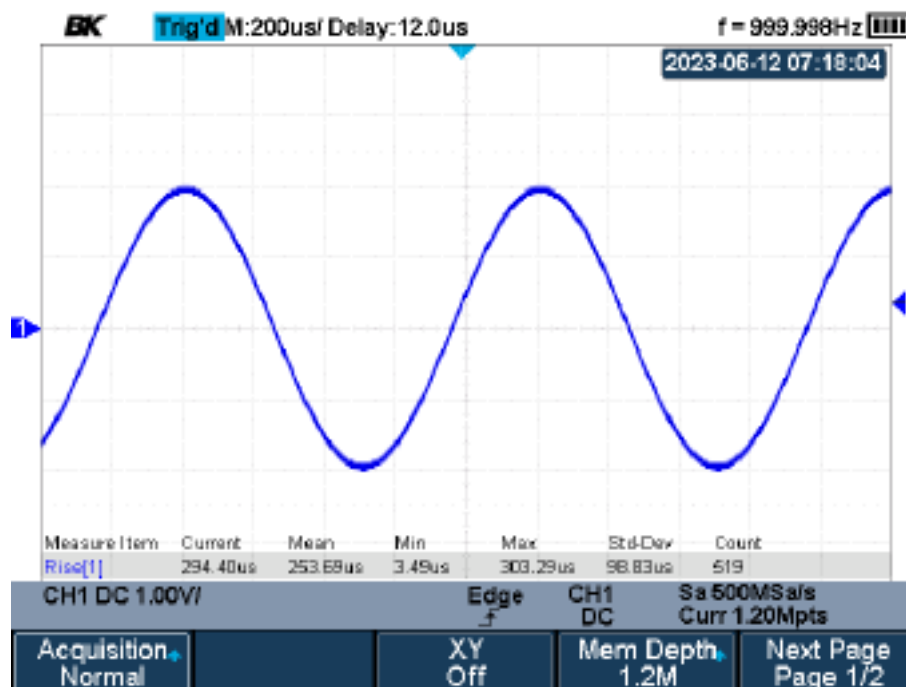

Figure 4.1 Normal Acquisition

Peak Detect Acquisition

The peak detect function of an oscilloscope is a feature that allows for the accurate measurement and capture of high-frequency and transient signals. It is particularly useful when observing signals that have rapid voltage changes, such as spikes or glitches.

When the peak detect function is enabled, the oscilloscope samples the input signal at a very high rate, typically much higher than the instrument's usual sampling rate. This increased sampling rate allows the oscilloscope to capture and store the highest instantaneous voltage value of the signal during each sampling period.

By capturing and displaying only the peak voltage values, the peak detect function provides a more detailed and precise representation of the signal's behavior, allowing users to analyze and troubleshoot complex waveforms effectively. It helps in detecting voltage anomalies that might otherwise be missed by the oscilloscope's normal acquisition modes, which usually use lower sampling rates and can miss brief voltage spikes.

The peak detect function enhances the oscilloscope's ability to capture and display fast and transient signals accurately, providing valuable insights into signal behavior and aiding in various applications such as electronics design, testing, and troubleshooting.

The oscilloscope acquires the maximum and minimum values of the signal within the sample interval to get the signal's envelope or the narrow pulse of the signal that might be lost. **Peak Detect** can prevent aliasing, however, the signal is more susceptible to noise.

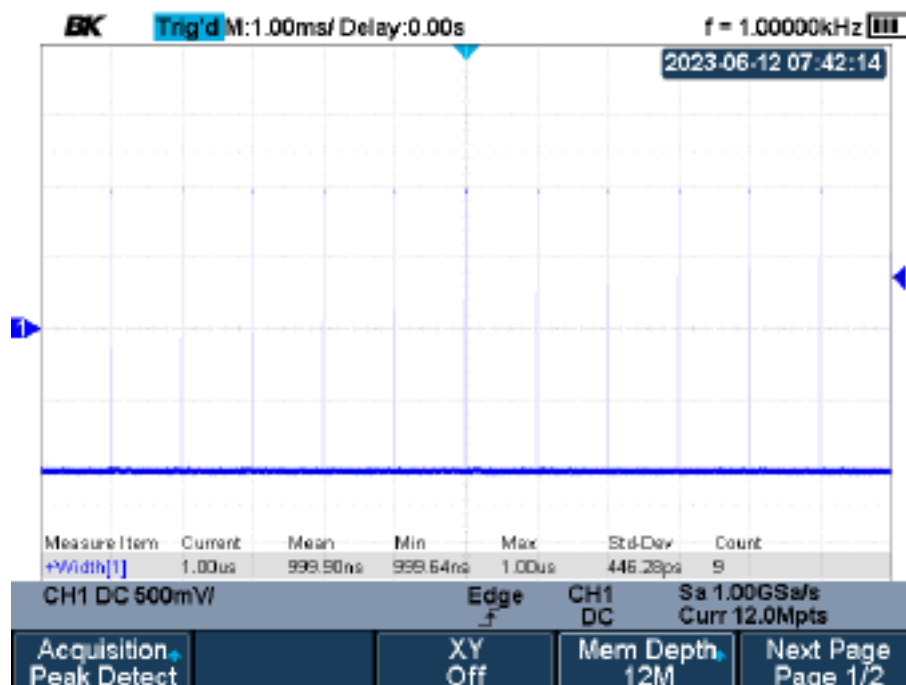

Figure 4.2 Peak Detect Acquisition

Average Acquisition

The oscilloscope averages the waveforms from multiple samples to reduce the random noise of the input signal and improve the vertical resolution.

The greater the number of averages is, the lower the noise and the higher the vertical resolution will be. Increasing the number of averages will decrease the response of the waveform display.

The available range of averages is from **4** to **1024** and the **default is 16**.

When **Average Acquisition** is selected:

- Press the **F2** button to select the average.
- A dropdown menu containing the available options will appear.
 - Use the **Universal Knob** to navigate the available options.
 - Repeatedly pressing the **F1** will also navigate through the available choices.

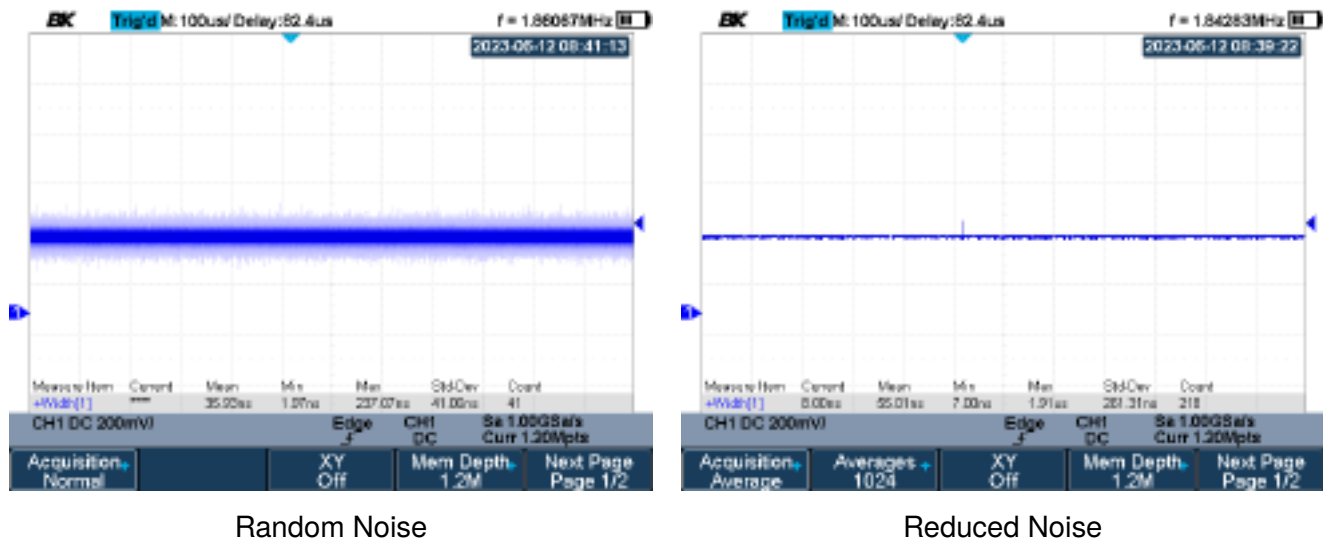

Figure 4.3 Average Acquisition

ERES Acquisition

The oscilloscope uses a kind of ultra-sample technique to average the neighboring points of the sample waveform to reduce the random noise on the input signal and generate much smoother waveforms on the screen. **ERES** mode is generally used when the sample rate of the digital converter is higher than the storage rate of the acquisition memory.

ERES mode can be used on single-shot and repetitive signals and does not slow waveform updates. This mode limits the oscilloscope's real-time bandwidth because it acts like a low-pass filter.

NOTICE

Average and **ERES** mode use different averaging methods. The former uses waveform average and the latter uses dot average.

4.2 Sampling Overview

To understand the oscilloscope's sampling and acquisition modes, it is helpful to understand sampling theory, aliasing, oscilloscope bandwidth and sample rate, oscilloscope rise time, oscilloscope bandwidth required, and how memory depth affects sample rate.

Sampling Theory

The Nyquist sampling theorem states that for a limited bandwidth (band- limited) signal with maximum frequency f_{MAX} , the equally spaced sampling frequency f_S must be greater than twice the maximum frequency f_{MAX} , in order to have the signal be uniquely reconstructed without aliasing.

$$f_{MAX} = F_{S/2} = \text{Nyquist frequency}(f_N) = \text{folding frequency}$$

Aliasing

Aliasing occurs when signals are under-sampled ($f_S < 2f_{MAX}$). Aliasing is the signal distortion caused by low frequencies falsely reconstructed from an insufficient number of sample points.

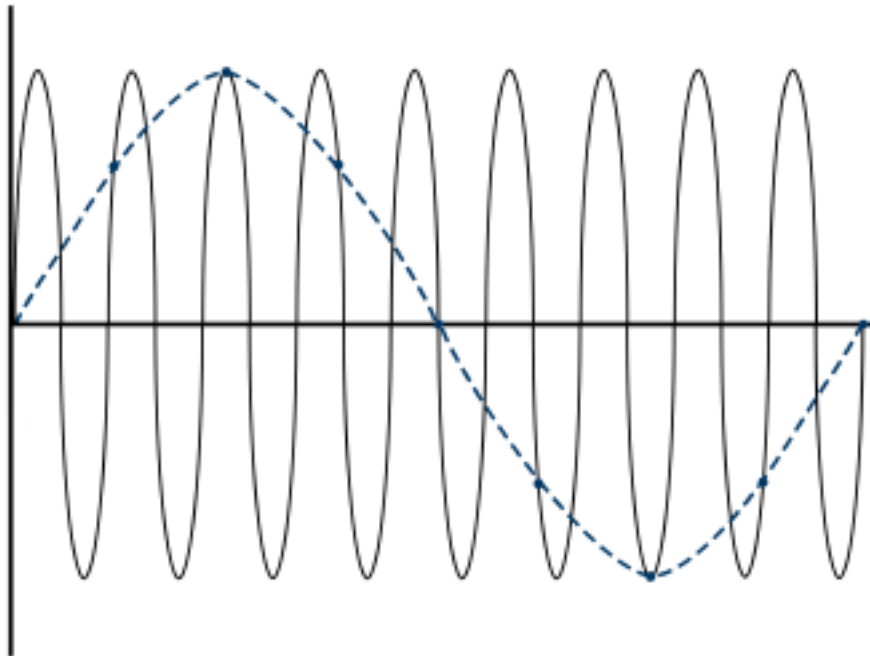

Figure 4.4 Aliasing

4.3 Bandwidth and Sample Rate

An oscilloscope's bandwidth is typically described as the lowest frequency at which input signal sine waves are attenuated by 3 dB (-30% amplitude error).

At the oscilloscope bandwidth, sampling theory says the required sample rate is $f_s = 2f_{BW}$. However, the theory assumes there are no frequency components above f_{MAX} (f_{BW} in this case) and it requires a system with an ideal brick-wall frequency response.

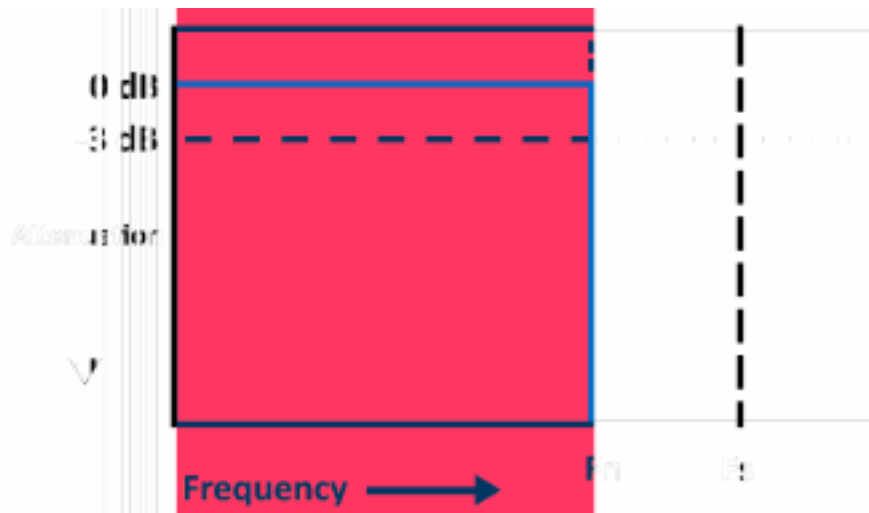

Figure 4.5 Brick-Wall Frequency Response

Digital signals have frequency components about the fundamental frequency (Square waves are made up of sine waves at the fundamental frequency and an infinite number of odd harmonics), and typically, for 500 MHz bandwidths and below, oscilloscopes have a Gaussian frequency response.

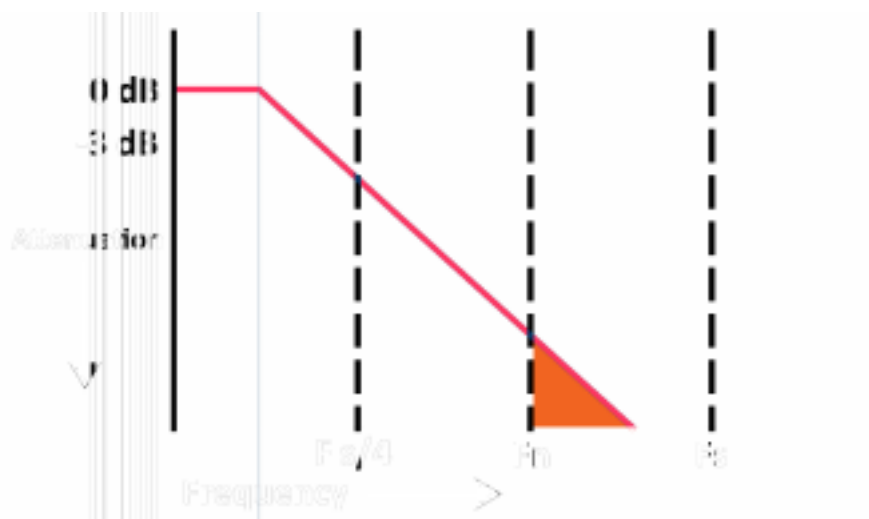

Figure 4.6 Bandwidth Limiting

In practice, an oscilloscope's sample rate should be four or more times its bandwidth: $f_s = 4x f_{BW}$. Doing so causes less aliasing, and aliased frequency components have a great amount of attenuation.

4.4 Memory Depth

Memory Depth refers to the number of waveform points that the oscilloscope can store in a single trigger sample.

The number of points of oscilloscope memory is fixed, and there is a maximum sample rate associated with oscilloscope's analog-to-digital converter; however, the actual sample rate is determined by the time of the acquisition (which is set according to the oscilloscope's horizontal time/div scale).

The relation of memory depth, sample rate, and waveform length fulfills the equation below:

$$\text{Memory Depth} = \text{sample rate} \times \text{time of acquisition}$$

For example, when storing 1 ms of data in 12M points of memory, the actual sample rate is 1 GSa/s.

Likewise, when storing 10 ms of data in 12M points of memory, the actual sample rate is 100 MSa/s.

The actual sample rate is displayed in the right-side information area. The oscilloscope achieves the actual sample rate by throwing away (decimating) unneeded samples.

To set the memory depth:



1. Press the **Acquire** button.
2. Press the **F4** softkey to select **Mem Deph**.
 - A dropdown menu containing the available options (refer to [table 4.2](#)) will appear.
3. Use the **Universal Knob** to navigate the available options.
 - Repeatedly pressing the **F4** will also navigate through the available choices.

Single Channel Mode	Dual Channel Mode
12 k	6 k
120 k	60 k
1.2 M	600 k
12 M	6 M

Table 4.2 Maximum Storage Depth

4.5 Sampling Mode

The oscilloscope only supports real-time sampling. In this mode, the oscilloscope samples and displays waveforms within a trigger event. The maximum real-time sample rate is 1GSa/s.

Press the  button to stop the sample. The oscilloscope will hold the last display and the button led will turn red . At this point, you can still use the vertical control and horizontal control to pan and zoom the waveform.



4.6 Interpolation Method

Under real-time sampling, the oscilloscope acquires the discrete sample values of the waveform being displayed. In general, a waveform of dots display type is very difficult to observe. In order to increase the visibility of the signal, the digital oscilloscope usually uses the interpolation method to display a waveform.

The interpolation method is a processing method to “connect all the sampling points”, and using some points to calculate the whole appearance of the waveform.

The interpolation method is used for real-time sampling to fill out the gaps between points and reconstruct an accurate waveform.

To set interpolation:

1. Press the  button.
2. Press the  softkey to select **Next Page**.
3. Press the  softkey to toggle between **Sin(x)/x** and **x** interpolation.

Sin(x)/x

Connecting the sampling points with curves has stronger versatility. Sinx interpolation method uses mathematical processing to calculate results in the actual sample interval. This method bending signal waveform, and make it produce a more realistic regular shape than pure square wave and pulse. It is recommended Sinx/s interpolation method be used when the sampling frequency is 3 to 5 times the bandwidth frequency of the system.

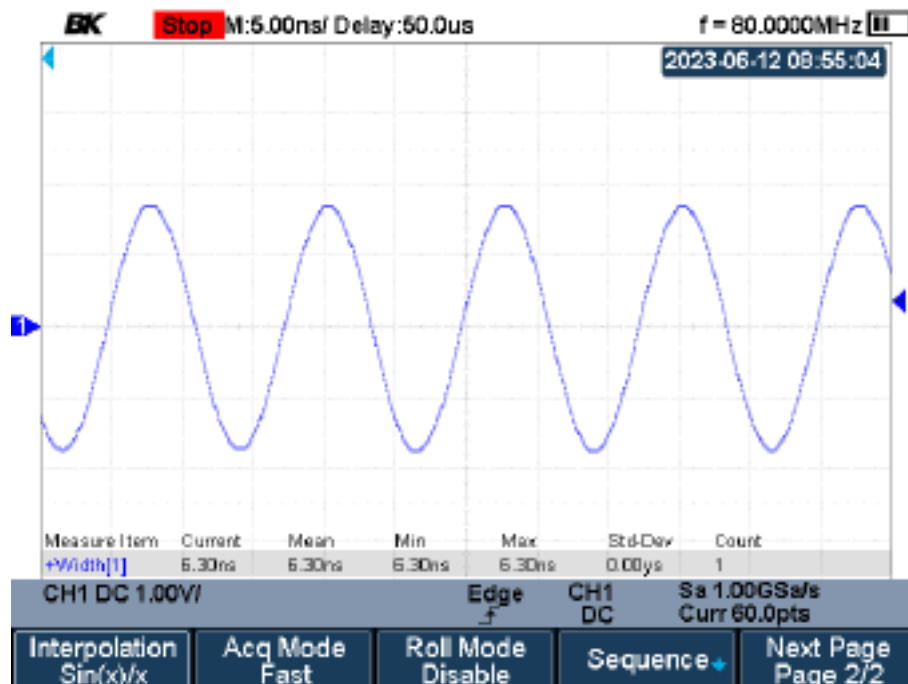

Figure 4.7 Interpolation Sin(x)/x

X

In the adjacent sample points are directly connected on a straight line. This method is only confined to rebuild on the edge of signals, such as a square wave.

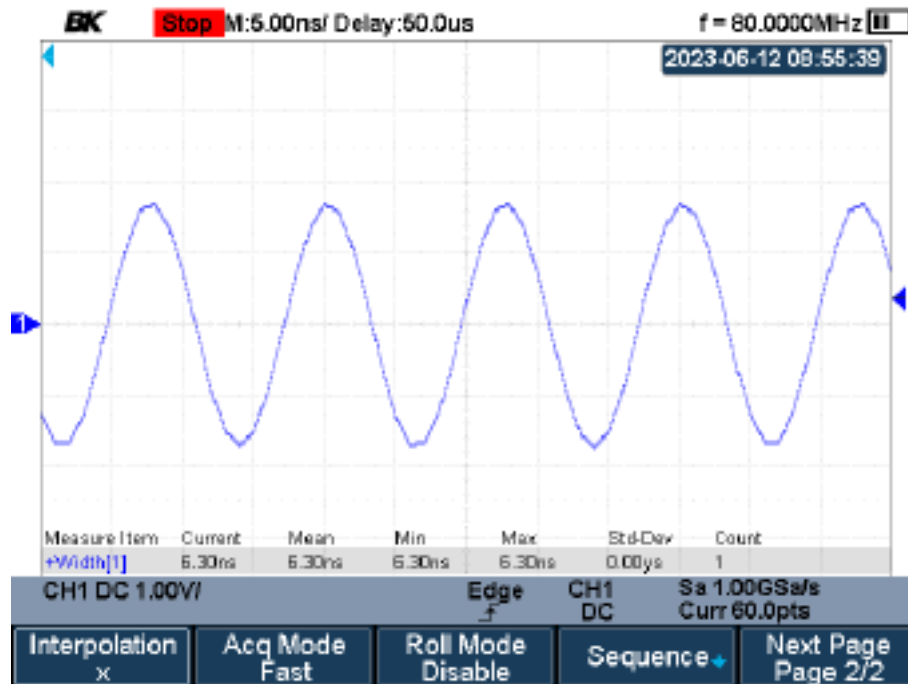

Figure 4.8 Interpolation X

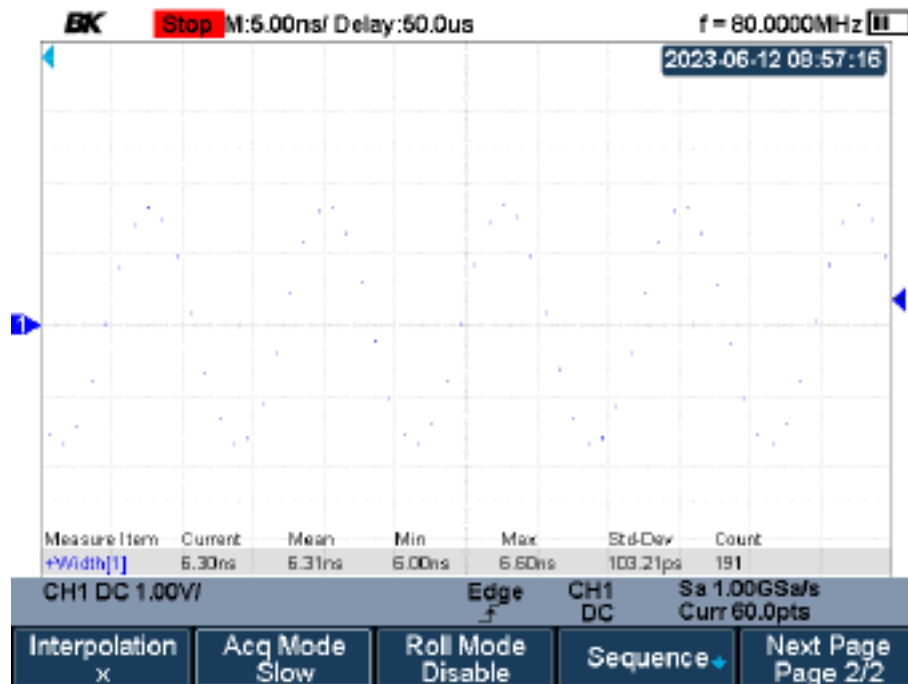

Figure 4.9 Dots

4.7 XY Time Mode

The XY time mode converts the oscilloscope from a volts-versus-time display to a volts-versus-volts display using the two input channels. Channel 1 is the X-axis input, channel 2 is the Y-axis input. You can use various transducers so the display could show strain versus displacement, flow versus pressure, volts versus current, or voltage versus frequency. YX mode can also be used to compare frequency and phase relationships between two signals.

NOTICE

Memory Depth decreases when XY mode is enabled, since both channels are enabled.

The figure below shows the measurement schematic diagram of the phase deviation.

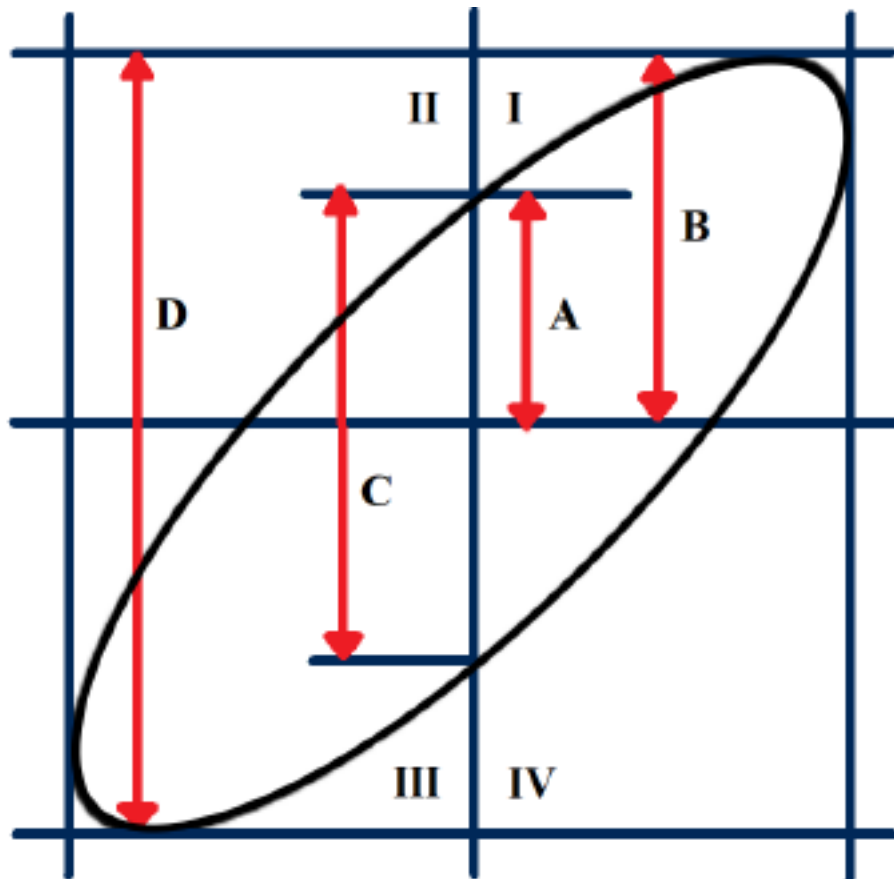



Figure 4.10 Phase Deviation

The phase deviation between two signals with the same frequency can be easily measured via Lissajous method:

$$\sin \theta = \frac{A}{B} \text{ or } \frac{C}{D}$$

Phase Deviation Calculation Example



1. Connect a sine wave signal to channel 1, and a sine wave signal of the same frequency but out of phase to channel 2.
2. Enable **XY** mode.
3. Center the signal on the display with the channel 1 and 2 position.
4. Adjust the signals for convenient viewing.
5. Press the  button.
6. Set the **Y2** cursor to the top of the signal, and set **Y1** to the bottom of the signal.
 - Note the ΔY value at the bottom of the display.
7. Move the **Y1** and **Y2** cursors to the intersection of the signal and the Y axis.
 - Note the ΔY value at the bottom of the display.
8. Calculate the phase difference using the formula:

$$\sin \theta = \frac{\text{second } \Delta Y}{\text{first } \Delta Y}$$

If the principal axis of the ellipse is within quadrant I and III, the phase deviation angle obtained should be within quadrants I and IV, namely within $(0 \text{ to } \pi/2)$ or $(3\pi/2 \text{ to } 2\pi)$. Suppose the principal axis of the ellipse is within quadrant II and IV. In that case, the phase deviation angle obtained should be within quadrant II and III, namely within $(\pi/2 \text{ to } \pi)$ or $(\pi \text{ to } 3\pi/2)$.

The X-Y function can be used to measure the phase deviation that occurred when the signal under test passes through a circuit network. Connect the oscilloscope to the circuit to monitor the input and output signals of the circuit.

To toggle **XY** mode:

1. Press the  button.
2. Press the  softkey to toggle **XY** mode on and off.

4.8 Sequence Mode

Sequence is another type of data acquisition. It does not display the waveform during the sampling process, instead it fills a memory segment for each trigger event. The oscilloscope continues to trigger until the memory is filled, and then displays the waveform on the screen.

This method improves the waveform capture rate up to 400,000 wfs/s, allowing for capturing of events with small probability of occurring.

To configure **Sequence** mode:

1. Press the **Acquire** button.
2. Press the **F5** softkey to select **Next Page**.
3. Press the **F4** softkey to select **Sequence**.
 - The **Sequence** submenu will be displayed.
4. Press the **F1** softkey to toggle **Sequence Acquisition Mode** on and off.
5. Press the **F2** softkey to set the **Max Segments**.
 - Use the **Universal Knob** to navigate the available options.
 - Pressing the **Universal Knob's** select button will display a numeric pad which can be used to set input the number of segments.

Refer to section History Frame Navigation for information on how to replay the acquired sequenced.

Trigger

This chapter introduces the available trigger types as well as the configuration of triggers.

5.1	Trigger Source	53
5.2	Trigger Mode	54
5.3	Trigger Level	56
5.4	Trigger Coupling	57
5.5	Trigger Holdoff	59
5.6	Noise Rejection	60
5.7	Trigger Type	61
5.7.1	Set Trigger Type	61

For triggering, certain condition can be set according to the requirement and when a waveform in the waveform stream meets this condition. Digital oscilloscope, display a waveform continuously regardless of the trigger stability, but only a stable trigger can ensure a stable display.

The trigger circuit ensures that every time base sweep or acquisition starts from the input signal and the user-defined trigger condition, namely every sweep is synchronous to the acquisition and the waveforms acquired overlap to display stable waveform.

Figure 5.1 demonstrates how the position of the trigger event determines the reference time point and the delay setting.

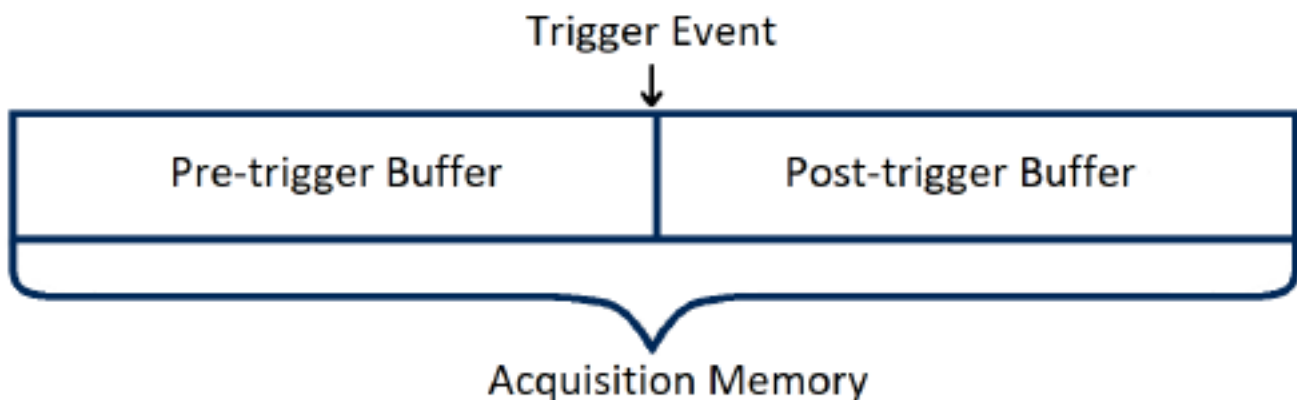

Figure 5.1 Acquisition Memory

A trigger setup tells the oscilloscope when to acquire and display data. Trigger settings are based on the features of the input signal, therefore knowledge of the signal under test is required to quickly capture the desired waveform.

5.1 Trigger Source



Trigger source selects the channel to whom the trigger setup will apply to. Signal inputs from the analog channels can be used as a trigger source.

The selected trigger source is displayed at the bottom of the screen.



Figure 5.2 Trigger Source

To select the trigger source:

1. Press the  button.
2. Press the  softkey to select **Source**.
 - A dropdown menu containing the available options will appear.
3. Use the **Universal Knob** to navigate the available options.
 - Repeatedly pressing  will also toggle between the available choices.

NOTICE

The selected trigger source is displayed at the bottom of the screen.



5.2 Trigger Mode

Trigger mode includes **Auto**, **Normal**, **Single** and **Force**. Trigger mode affects how the oscilloscope searches for the trigger.

After the oscilloscope starts running, the oscilloscope operates by first filling the pre-trigger buffer. It starts searching for a trigger after the pre-trigger buffer is filled and continues to flow data through this buffer while it searches for the trigger. While searching for the trigger, the oscilloscope overflows the pre-trigger buffer and the first data put into the buffer is first pushed out (First Input First Out, FIFO).

When a trigger is found, the pre-trigger buffer contains the events that occurred before the trigger. Then, the oscilloscope fills the post-trigger buffer and displays the acquisition memory.

To select the trigger mode:

1. Press the  button.
2. Press the  softkey to select **Next Page**.
3. Press the  softkey to select **Mode**.
 - A dropdown menu containing the available options will appear.

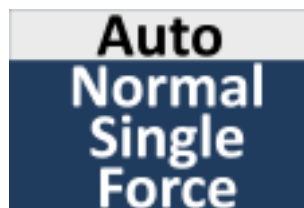



Figure 5.3 Trigger Modes

4. Use the **Universal Knob** to navigate the available options.
 - Repeatedly pressing  will navigate between the available choices.

Auto Trigger

If the specified trigger conditions are not found, triggers are forced and acquisitions are made so that signal activity is displayed on the oscilloscope. The Auto trigger mode is appropriate when:

- Checking DC signals or signals with unknown levels or activity.
- When trigger conditions occur often enough that forced triggers are unnecessary

Normal Trigger

Triggers and acquisitions only occur when the specified trigger conditions are found. The Normal trigger mode is appropriate when:

- You only want to acquire specific events specified by the trigger settings.
- Triggering on an infrequent signal from a serial bus (for example, I2C, SPI, CAN, LIN, etc.) or another signal that arrives in bursts. The Normal trigger mode lets you stabilize the display by preventing the oscilloscope from auto-triggering.

Single

Trigger and acquisition only occurs once when the specified trigger condition is found. Single trigger mode is appropriate when:

- You only want to capture a single event or a periodic signal.
- You only want to capture a burst or other unusual signals.

Force Trigger

In the Force trigger mode, when the trigger condition is not met, it will be force triggered after the frame is acquired. The trigger status in the upper left corner of the screen will be displayed as **FStop**.

5.3 Trigger Level

Trigger level defines the trigger point.

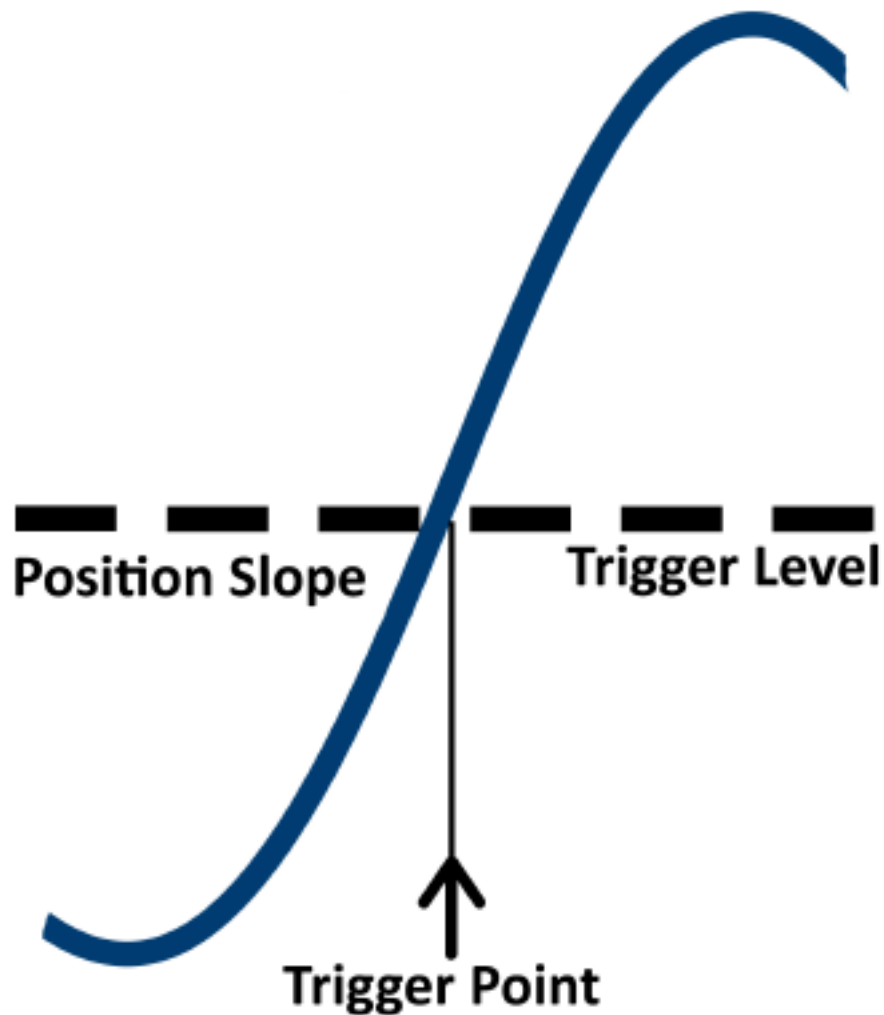



Figure 5.4 Trigger Point

The position of the trigger level for the analog channel is indicated by the trigger level icon  (if the analog channel is on) at the far left side of the display.

To adjust the trigger level:

1. Press the  button.
2. Use the **Universal Knob** to adjust the value of the trigger level.
 - Press the **Universal Knob** to set the level to the waveform's 50% value.
 - If AC coupling is used, pushing the **Universal Knob** sets the trigger level to about 0 V.



5.4 Trigger Coupling

The 2510B provides **DC**, **AC**, **LF Reject**, and **HF**.

NOTICE

Trigger coupling is independent of channel coupling.

To set the trigger coupling:

1. Press the  button.
2. Press the  softkey to select **Next Page**.
3. Press the  softkey to select **Coupling**.
 - A dropdown menu containing the available options will appear.

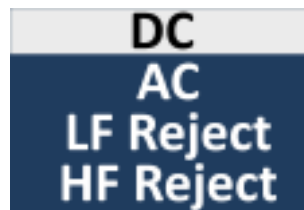



Figure 5.5 Trigger Coupling

4. Use the **Universal Knob** to navigate the available options.
 - Repeatedly pressing  will navigate between the available choices.

DC Coupling

Allows both DC and AC components into the trigger path.

AC Coupling

Blocks all the DC components and attenuate signals lower than 8 Hz.

Use AC coupling to get a stable edge trigger when your waveform has a large DC offset.

LF Reject

Blocks the DC components and reject the low frequency components lower than 2 MHz. Low frequency Reject removes unwanted low frequency components from a trigger waveform, such as power line frequencies, etc. that can interfere with proper triggering.

Use LF Reject coupling to get a stable edge trigger when your waveform has low frequency noise.

HF Reject

Reject the high frequency components higher than 1.2 MHz.

5.5 Trigger Holdoff

Trigger holdoff can be used to stably trigger the complex waveforms (such as pulse series). Holdoff time is the amount of time that the oscilloscope waits before re-arming the trigger circuitry. The oscilloscope will not trigger until the holdoff time expires.

Use the holdoff to trigger repetitive waveforms with multiple edges (or other events) between waveform repetitions. You can also use holdoff to trigger on the first edge of a burst when you know the minimum time between bursts.

For example, to get a stable trigger on the repetitive pulse burst below, set the holdoff time to be >200 ns but <600 ns.

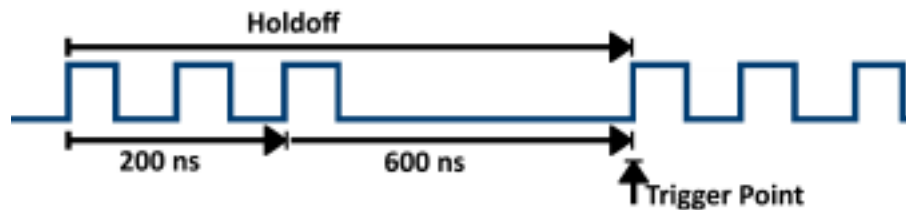

Figure 5.6 Trigger Holdoff Example

The correct holdoff setting is typically slightly less than one repetition of the waveform. Set the holdoff to this time to generate a unique trigger point for a repetitive waveform. Only edge trigger and serial trigger have holdoff option. The holdoff time of the oscilloscope is adjustable from 80ns to 1.5s.

To enable and configure trigger holdoff:

1. Press the **F4** softkey to toggle **Holdoff**.
2. When enabled, use the **Universal Knob** to adjust the **Holdoff Time**.
 - Press the **Universal Knob** to display the numeric keypad.
 - Holdoff time can be set from 80 ns to 1.5 s.



NOTICE

Adjusting the time scale and horizontal position will not affect the holdoff.

5.6 Noise Rejection

Noise Reject adds additional hysteresis to the trigger circuitry. By increasing the trigger hysteresis band, the possibility of triggering on noise is reduced. However, this decreases the trigger sensitivity, requiring a larger signal to trigger the oscilloscope.

To toggle noise reject:

1. Press the  button to open the trigger menu.
2. Press the
3. Press the  softkey to select **Next Page**.
4. Press the
5. Press the  softkey to toggle **Noise Reject** on or off.

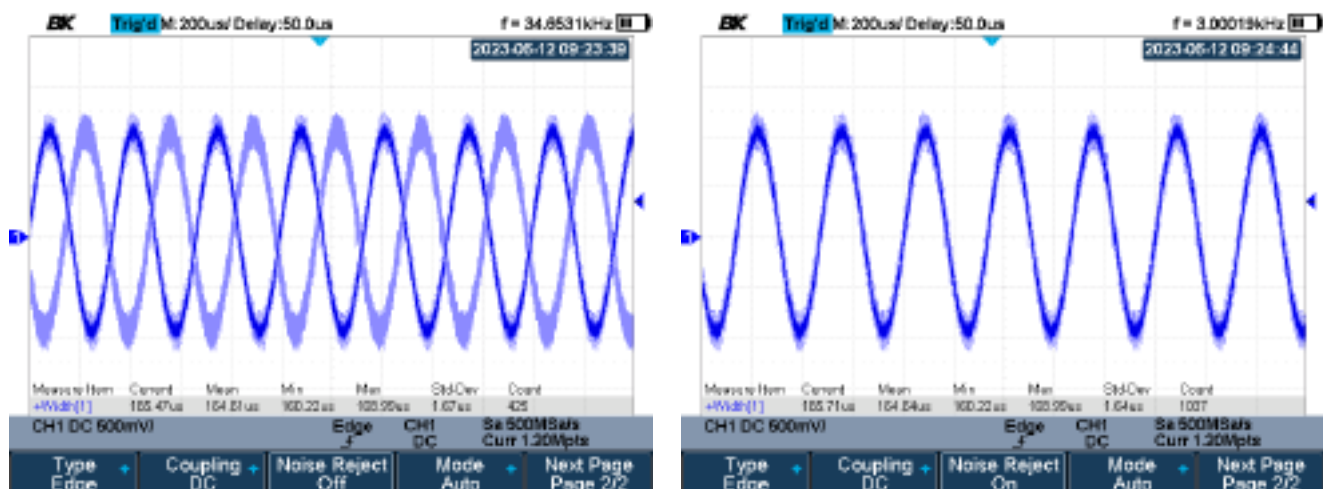

Noise Reject Disabled

Noise Reject Enabled

Figure 5.7 Noise Reject

If the signal you are probing is noisy, set up the oscilloscope to reduce the noise in the trigger path and on the displayed waveform.

First, stabilize the displayed waveform by removing the noise from the trigger path. Second, reduce the noise on the displayed waveform.

1. Connect a signal to the oscilloscope and obtain a stable display.
2. Remove the noise from the trigger path by setting trigger coupling to **LF Reject**, **HF Reject** or turning on **Noise Reject**.
3. Set the acquisition option to **Average** to reduce noise on the displayed waveform.

5.7 Trigger Type

In addition to the **Edge Trigger** type, you can also set up triggers for **Slope**, **Pulse**, **Video**, **Window**, **Interval**, **Dropout**, **Runt**, and **Pattern**.

Changes to the trigger setup are applied immediately. If the oscilloscope is stopped when you change a trigger setup, the oscilloscope uses the new specification when you press the **Run Stop** button. If the oscilloscope is running when you change a trigger setup, it uses the new trigger definition when it starts the next acquisition

5.7.1 Set Trigger Type

To set the trigger type:

1. Press the **Trigger Setup** button to open the Trigger menu.
2. Press the **F1** button to select **Type**.
 - A dropdown menu containing the available options will appear.

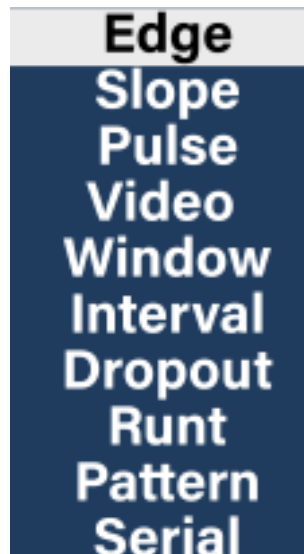

Figure 5.8 Trigger Types

3. Use the **Universal Knob** to navigate the available options.
 - Repeatedly pressing **F4** will navigate between the available choices.

Edge Trigger

The edge trigger type identifies a trigger by looking for a specified edge (rising, falling, or alternating) and voltage level on a waveform. The trigger type, source, and level are displayed in the lower-center of the display.

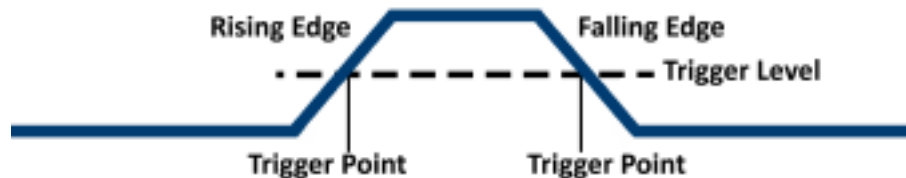

Figure 5.9 Edge Trigger

NOTICE

Alternating edge mode is useful when you want to trigger on both edges of a clock (for example, DDR signals).

The easiest way to set up an Edge trigger on a waveform is to use Autoscale. Simply press the **Auto Setup** button and the oscilloscope will attempt to trigger on the waveform using a simple Edge trigger type and rising slope.

Holdoff, coupling and noise reject can be set in edge trigger, see the sections **Trigger Holdoff**, **Trigger Coupling**, and **Noise Reject**.

To set the slope of the edge trigger:

1. Press the **Trigger Setup** button to enter the trigger menu.
2. Press the **F3** button to select **Slope**.
 - A dropdown menu containing the available options will appear.



Figure 5.10 Slope

3. Use the **Universal Knob** to navigate the available options.
 - Repeatedly pressing **F4** will navigate between the available choices.

Slope Trigger

The slope trigger looks for a rising or falling transition from one level to another level in greater than or less than a certain amount of time.

In the oscilloscope, positive slope time is defined as the time difference between the two crossing points of trigger level line A and B with the positive edge as shown in the figure below.

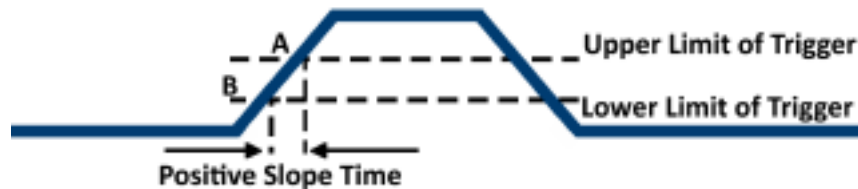

Figure 5.11 Slope Trigger

Coupling and noise reject can be set in edge trigger, see the sections [Trigger Coupling](#), and [Noise Reject](#).

To set the slope of the trigger:



1. Press the  button to enter the trigger menu.
2. Press the  button to select **Slope**.
 - A dropdown menu containing the available options will appear.



Figure 5.12 Slope

3. Use the [Universal Knob](#) to navigate the available options.
 - Repeatedly pressing  will toggle between **Rising** and **Falling**.

Configure Slope Trigger

When trigger type is set to **Slope** the limit range and lower and upper trigger limits must be configured.

To set the **Limit Range**:







1. Press the  button to enter the trigger menu.
2. Press the  softkey to select the **Limit Range Type**.
 - A dropdown menu containing the available options will appear.



Figure 5.13 Limit Range

3. Use the **Universal Knob** to navigate the available options.
 - Repeatedly pressing  will navigate between the available choices.
4. Press the  softkey to select **Next Page**
5. Press the  softkey to configure the **Limit Range Value(s)**.
 - If a range type was selected pressing the  will toggle between the low and high limit.
6. Use the **Universal Knob** to configure the limit range value.
 - Pressing the **Universal Knob** will open the numeric keypad in the display.
7. Press the  button to toggle between lower and upper trigger value.
8. Use the **Universal Knob** to configure the selected trigger value.
 - Pressing the **Universal Knob** will open the numeric keypad in the display.

Limit Range Type

< = (less than a time value)

Trigger when the input signal's positive or negative slope time is lower than the specified time value.

> = (greater than a time value)

Trigger when the input signal's positive or negative slope time is greater than the specified time value.

[- . . -] (within a range of time value)

Trigger when the input signal's positive or negative slope time is greater than the specified lower limit of time and lower than the specified upper limit of time value.

- -] [- - (outside a range of time value)

Trigger when the input signal's positive or negative slope time is greater than the specified upper limit of time and lower than the specified lower limit of time value.

Pulse Trigger

Pulse triggering sets the oscilloscope to trigger on a positive or negative pulse of a specified width. To trigger on a specified timeout value, use [Pattern Trigger](#).

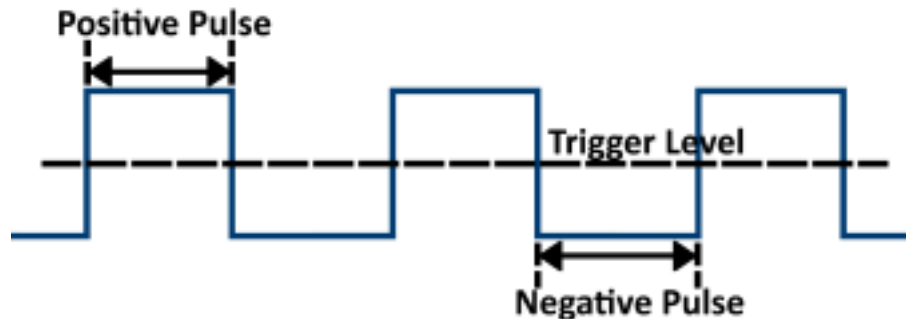

Figure 5.14 Pulse Trigger

Coupling and noise reject can be set in edge trigger, see the sections [Trigger Coupling](#), and [Noise Reject](#).

Configure Pulse Trigger

When trigger type is set to **Pulse** the limit range and polarity must be configured.

To set the **Limit Range**:





1. Press the  button to enter the trigger menu.
2. Press the  button to toggle between positive and negative polarity.
3. Press the  softkey to select the **Limit Range Type**.
 - A dropdown menu containing the available options will appear.



Figure 5.15 Limit Range

4. Use the **Universal Knob** to navigate the available options.
 - Repeatedly pressing  will navigate between the available choices.

5. Press the **F5** softkey to select **Next Page**
6. Press the **F2** softkey to configure the **Limit Range Value(s)**.
 - If a range type was selected pressing the **F2** will toggle between the low and high limit.
7. Use the **Universal Knob** to configure the limit range value.
 - Pressing the **Universal Knob** will open the numeric keypad in the display.

Limit Range Types

< = (less than a time value)

Trigger when the input signal's positive or negative pulse time is lower than the specified time value. For example, for a positive pulse, if you set t (pulse real width) $\leq 100\text{ns}$, the waveform will trigger.



Figure 5.16 < = (less than a time value)

> = (greater than a time value)

Trigger when the input signal's positive or negative pulse time is greater than the specified time value. For example, for a positive pulse, if you set t (pulse real width) $\geq 100\text{ns}$, the waveform will trigger.



Figure 5.17 > = (greater than a time value)

[- . . -] (within a range of time value)

Trigger when the input signal's positive or negative pulse time is greater than the specified lower limit of time and lower than the specified upper limit of time value. For example, for a positive pulse, if you set t (pulse real width) $\geq 100\text{ns}$ and $t \leq 300\text{ns}$, the waveform will trigger



Figure 5.18 [- . . -] (within a range of time value)

- -] [- - (outside a range of time value)

Trigger when the input signal's positive or negative pulse time is greater than the specified upper limit of time and lower than the specified lower limit of time value.

Video Trigger



Video triggering can be used to capture the complicated waveforms of most standard analog video signals. The trigger circuitry detects the vertical and horizontal interval of the waveform and produces trigger based on the video trigger settings you have selected.

The oscilloscope supports standard video signal field or line of NTSC (National Television Standards Committee), PAL (Phase Alternating Line) HDTV (High Definition Television) and custom video signal trigger.

Configure Video Trigger

When Trigger type is set **Video** the standard must be specified.

To specify the **Standard**:

1. Press the  button to enter the trigger menu.
2. Press the  softkey to select **Standard**.
 - A dropdown menu containing the available options will appear.
3. Use the **Universal Knob** to navigate the available options (see [table 5.1](#)).
 - Repeatedly pressing  will navigate between the available choices.

Standard	Type	Sync Pulse
NTSC	Interlaced	BI-level
PAL	Interlaced	BI-level
HDTV 720P/50	Progressive	Tri-level
HDTV 720P/60	Progressive	Tri-level
HDTV 1080P/50	Progressive	Tri-level
HDTV 1080P/60	Progressive	Tri-level
HDTV 1080i/50	Progressive	Tri-level
HDTV 1080i/50	Progressive	Tri-level

Table 5.1 Video Standards

Custom		
Frame Rate	25Hz, 30Hz, 50Hz, 60Hz	
Of Lines	300 ~ 2000	
Of Fields	1, 2, 3, 4	
Interlace	1:1, 2:1, 4:1, 8:1	
Trigger Position	Line	Field
	(line value)/1	1
	(line value)/2	2
	(line value)/3	3
	(line value)/4	4
	(line value)/5	5
	(line value)/6	6
	(line value)/7	7
	(line value)/8	8

Table 5.2 Custom Video Standards

The table below takes **Of Lines** as 800 as an example to explain the relation between **Of Lines**, **Of Fields**, **Interlace**, **Trigger Line** and **Trigger Field**.

Of Lines	Of Fields	Interlace	Trigger Line	Trigger Field
800	1	1:1	800	1
800	1,2,4 or 8	2:1	400	1, 1 ~ 2, 1 ~ 4, 1 ~ 8
800	1,2,4 or 8	4:1	200	1, 1 ~ 2, 1 ~ 4, 1 ~ 8
800	1,2,4 or 8	8:1	100	1, 1 ~ 2, 1 ~ 4, 1 ~ 8

Table 5.3 Explaining Relationship

4. Press the **F5** softkey to select **Next Page**.
 - Navigate to page 2.
5. Press the **F2** softkey to toggle **Sync** between **Any** and **Select**.
 - **Any**: trigger on any of the horizontal sync pulses.
 - **Select**: trigger on the appointed line and field you have set.
6. If **Sync** was set to **Select**.
 - Press the **F3** or **F4** softkey; then turn the **Universal Knob** to set the **Line** or **Field** value respectively.

The following table lists the line numbers per field for each video standard.

Standard	Field 1	Field 2
NTSC	1 to 262	1 to 263
PAL	1 to 312	1 to 313
HDTV 720P/50, HDTV 720P/60	1 to 750	
HDTV 1080P/50, HDTV 1080P/60	1 to 1125	
HDTV 1080iP/50, HDTV 1080i/60	1 to 562	1 to 563

Table 5.4 Line Numbers

Window Trigger

Windows trigger provides a high trigger level and a low trigger level. The instrument triggers when the input signal passes through the high trigger level or the low trigger level.

There are two kinds of window types: **Absolute** and **Relative**. They have different trigger level adjustment methods.

Under **Absolute** window type, the lower and the upper trigger levels can be adjusted respectively via the Level knob

Under **Relative** window type, adjust the Center value to set the window center

Adjust the **Delta** value to set the window range, the lower and the upper trigger levels always move together.

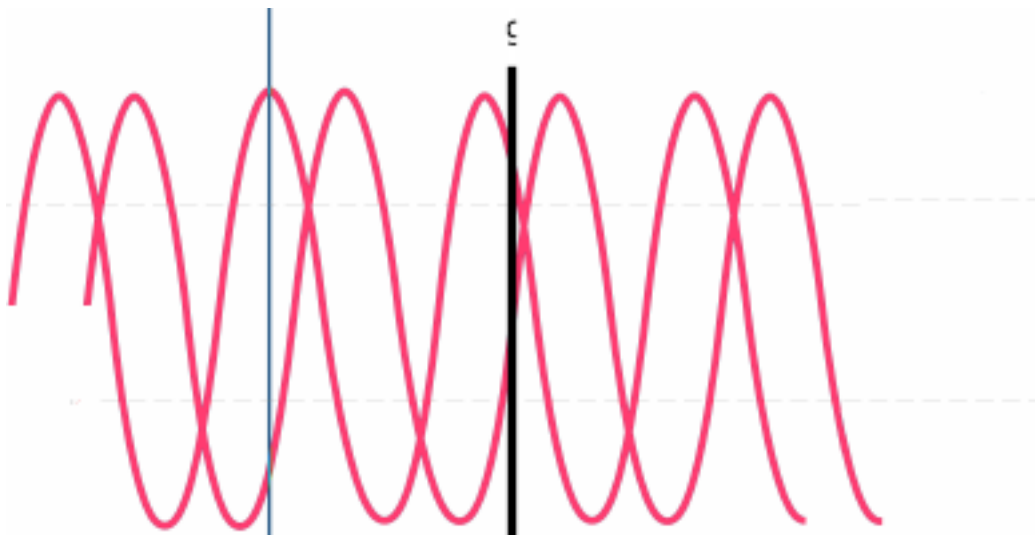





Figure 5.19 Window Trigger

- If the lower and the upper trigger levels are both within the waveform amplitude range, the oscilloscope will trigger on both rising and falling edge.
- Suppose the upper trigger level is within the waveform amplitude range while the lower trigger level is out of the waveform amplitude range. In that case, the oscilloscope will trigger on rising edge only.
- Suppose the lower trigger level is within the waveform amplitude range while the upper trigger level is out of the waveform amplitude range. In that case, the oscilloscope will trigger on falling edge only.





Configure Absolute Window Trigger

To configure the window trigger via absolute window type:

1. Press the  button to enter the trigger menu.
2. Press the  softkey to toggle between absolute and relative.
3. Press the  softkey to toggle lower and upper trigger level.
 - Upon selecting the trigger level press the  button and use the **Universal Knob** to adjust the trigger level.

Configure Relative Window Trigger

To configure the window trigger via absolute window type:

1. Press the  button to enter the trigger menu.
2. Press the  softkey to toggle between absolute and relative.
3. Press the  softkey to toggle center and delta trigger level.
 - Upon selecting the trigger level press the  button and use the **Universal Knob** to adjust the trigger level.

Coupling and noise reject can be set in Window trigger, see the sections **Trigger Coupling** and **Noise Rejection** for more details.

Interval Trigger

Trigger when the times difference between the neighboring rising or falling edges meets the limit.

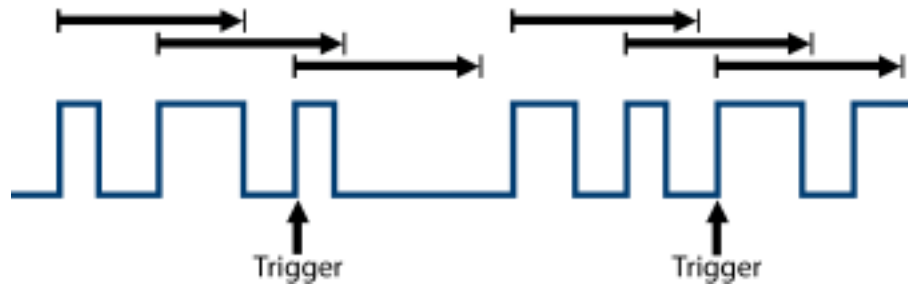

Figure 5.20 Interval Trigger

Configure Interval Trigger

To configure interval trigger:

1. Press the **Trigger Setup** button to enter the trigger menu.
2. Press the **F3** button to toggle between positive and negative polarity.
3. Press the **F4** softkey to select the **Limit Range Type**.
 - A dropdown menu containing the available options will appear.



Figure 5.21 Limit Range

4. Use the **Universal Knob** to navigate the available options.
 - Repeatedly pressing **F4** will navigate between the available choices.
5. Press the **F5** softkey to select **Next Page**
6. Press the **F2** softkey to configure the **Limit Range Value(s)**.
 - If a range type was selected pressing the **F2** will toggle between the low and high limit.
7. Use the **Universal Knob** to configure the limit range value. Pressing the **Universal Knob** will open the numeric keypad in the display.

Dropout Trigger

The dropout trigger includes two types: edge and state.

Edge

Trigger when the time interval (ΔT) from when the rising edge (or falling edge) of the input signal passes through the trigger level to when the neighboring rising edge (or falling edge) passes through the trigger level is greater than the timeout time set, as shown in the figure below.

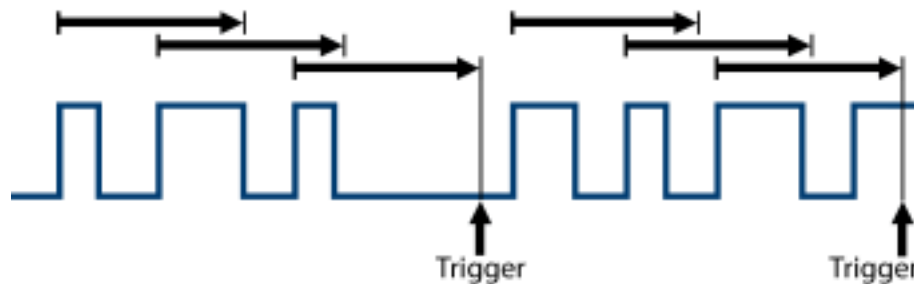

Figure 5.22 Edge

Configure Edge Dropout Trigger

To configure an edge dropout trigger:

1. Press the **Trigger Setup** button to enter the trigger menu.
2. Press the **F4** button to toggle between **Edge** and **State** type.
3. Press the **F5** softkey to select **Next Page**.
 - Navigate to **Page 2/3**.
4. Press the **F2** softkey to select **Time**.
5. Use the **Universal Knob** to configure the limit range value.
 - Pressing the **Universal Knob** will open the numeric keypad in the display.

State

Trigger when the time interval (ΔT) from when the rising edge (or falling edge) of the input signal passes through the trigger level to when the neighboring falling edge (or rising edge) passes through the trigger level is greater than the timeout time set, as shown in the figure below.

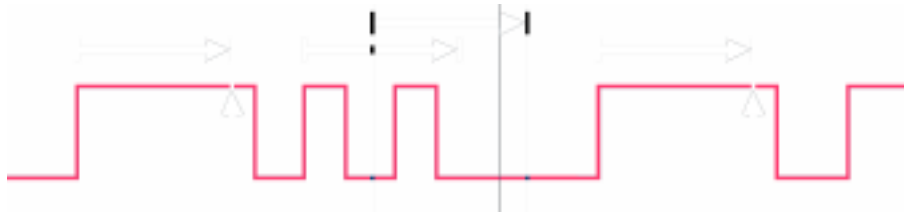

Figure 5.23 State

Configure State Dropout Trigger

To configure an state dropout trigger:

1. Press the **Trigger Setup** button to enter the trigger menu.
2. Press the **F4** button to toggle between **Edge** and **State** type.
3. Press the **F5** softkey to select **Next Page**.
 - Navigate to **Page 2/3**.
4. Press the **F2** softkey to select **Time**.
5. Use the **Universal Knob** to configure the limit range value.
 - Pressing the **Universal Knob** will open the numeric keypad in the display.

Coupling and noise reject can be set in dropout trigger, see the sections **Trigger Coupling** and **Noise Rejection** for more details.

Runt Trigger

The runt trigger looks for pulses that cross one threshold but not another.

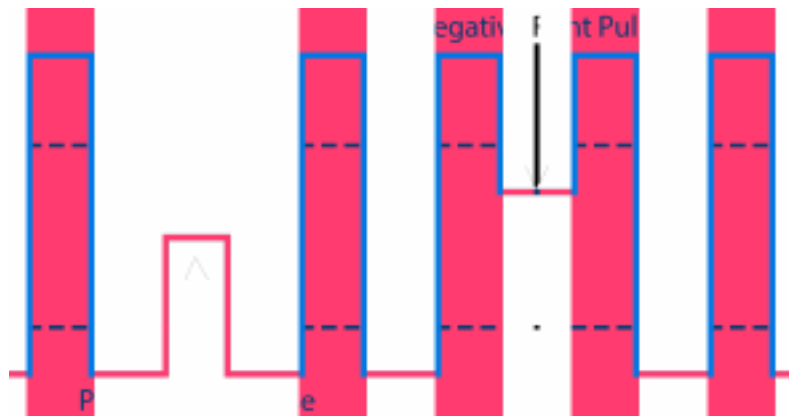

Figure 5.24 Runt Trigger

- A positive runt pulse crosses through a lower threshold but not an upper threshold.
- A negative runt pulse crosses through an upper threshold but not a lower threshold.

Configure a Runt Trigger

To trigger on a runt pulse:

1. Press the **Trigger Setup** button to enter the trigger menu.
2. Press the **F3** button to toggle between positive and negative polarity.
3. Press the **F4** softkey to select the **Limit Range Type**.
 - A dropdown menu containing the available options will appear.
4. Use the **Universal Knob** to navigate the available options.
 - Repeatedly pressing **F4** will navigate between the available choices.
5. Press the **F5** softkey to select **Next Page**
6. Press the **F2** softkey to configure the **Limit Range Value(s)**.
 - If a range type was selected pressing the **F2** will toggle between the low and high limit.
7. Use the **Universal Knob** to configure the limit range value. Pressing the **Universal Knob** will open the numeric keypad in the display.
8. Press the **F3** softkey to toggle between **Lower** and **Upper**.
 - Upon selecting the trigger level press the **Trigger Level** button and use the **Universal Knob** to adjust the trigger level.

Pattern Trigger

The pattern trigger identifies condition by looking for a specified pattern. The pattern trigger can be expanded to incorporate delays similar to other triggers. Pattern durations are evaluated using a timer. The timer starts on the last edge that makes the pattern “true”.

Potential triggers occur on the first edge that makes the pattern false, provided that the time qualifier criterion has been met. The oscilloscope provides 4 patterns: logical AND, OR, NAND and NOR combination of the channels. Each channel can set to low, high or invalid.

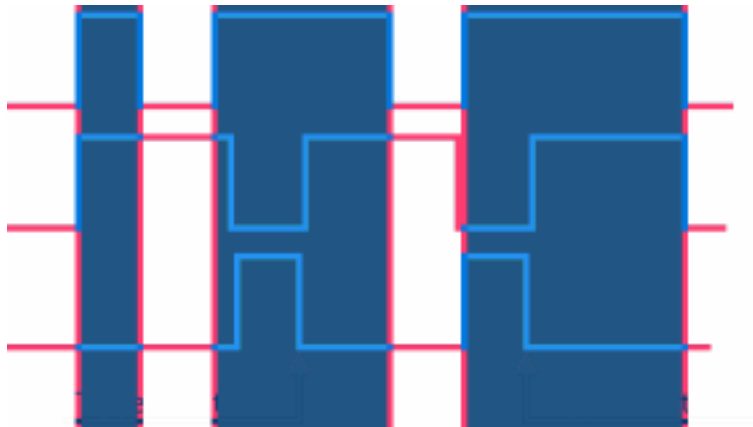

Figure 5.25 Pattern Trigger

Configure Pattern Trigger

1. Press the **Trigger Setup** button to enter the trigger menu.
2. Press the **F3** button to select **Level Type**.
 - A dropdown menu containing the available options will appear.



Figure 5.26 Level Type

3. Use the **Universal Knob** to navigate the available options.
 - Repeatedly pressing **F3** will navigate between the available choices.
4. Press the **F5** softkey to select **Next Page**

5. Press the **F2** softkey to configure the **Logic**.
 - A dropdown menu containing the available options will appear.

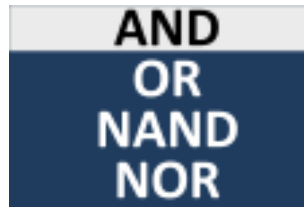

Figure 5.27 Logic

6. Low sets the pattern to low on the selected channel. A low is a voltage level that is less than the channel's trigger level or threshold level.
7. High sets the pattern to high on the selected channel. A high is a voltage level that is greater than the channel's trigger level or threshold level.
8. Don't care sets the pattern to don't care on the selected channel. Any channel set to don't care is ignored and is not used as part of the pattern.
9. However, if all channels in the pattern are set to Don't care, the oscilloscope will not trigger.
10. Adjust the trigger level for the selected analog channel by pressing the Trigger Level button and turning the Universal Knob. Don't care doesn't need to set trigger level.
11. Use the **Universal Knob** to navigate the available options.
 - Repeatedly pressing **F3** will navigate between the available choices.
12. Press the **F3** softkey to select **Time**.
13. Use the **Universal Knob** to navigate the available options.
 - Repeatedly pressing **F4** will navigate between the available choices.

Serial Trigger and Decode

The serial trigger and decode function feature allows for the analysis and decoding of digital serial data signals. It is particularly useful when working with communication protocols such as I2C, SPI, UART, CAN, and LIN.

The serial trigger function enables the oscilloscope to trigger on specific events or patterns within the serial data stream. This ensures that the oscilloscope captures the desired data for further analysis. For example, you can set the trigger to activate when a specific byte, word, or frame pattern is detected within the serial data.

Once the oscilloscope triggers on the desired event, the decode function comes into play. It interprets the raw serial data and decodes it into a human-readable format, making it easier to analyze and understand the communication between devices. The oscilloscope can automatically identify and display various elements of the serial data, such as start and stop bits, addresses, data bytes, and even error conditions.

The decoded information is displayed alongside the corresponding waveform, providing a comprehensive view of the digital signal. This allows you to quickly identify and analyze specific data packets or troubleshoot communication issues by visually inspecting the waveform and the decoded data simultaneously.

The 2510B series provides I2C, SPI, UART, CAN and LIN serial trigger and decode. This chapter introduces the method of triggering and decoding these serial signals in detail.

6.1	I2C Trigger and Serial Decode	81
6.1.1	I2C Setup	81
6.1.2	I2C Trigger Conditions	83
6.1.3	I2C Trigger Configuration	86
6.1.4	I2C Serial Decode	87
6.1.5	Interpreting I2C Decode	88
6.2	SPI Trigger and Serial Decode	89
6.2.1	SPI Setup	89
6.2.2	SPI Trigger	91
6.2.3	SPI Serial Decode	92
6.2.4	Interpreting SPI Decode	93
6.3	UART Trigger and Serial Decode	94
6.3.1	UART Setup	94
6.3.2	UART Trigger	96
6.3.3	UART Serial Decode	97
6.3.4	Interpreting UART Decode	98
6.4	CAN Trigger and Serial Decode	99
6.4.1	CAN Setup	99

6.4.2	CAN Trigger	100
6.4.3	CAN Serial Decode	101
6.5	LIN Trigger and Serial Decode	103
6.5.1	LIN Setup	103
6.5.2	LIN Trigger	104
6.5.3	CAN Serial Decode	105

6.1 I2C Trigger and Serial Decode

6.1.1 I2C Setup

Setting the I2C (Inter-IC bus) signal includes two steps: connecting the serial data signal (SDA) and serial clock signal (SCK) to oscilloscope, and specifying the threshold voltage of each input signal.

1. Press the **Shift** then the **Decode** to enter the **Decode** menu.

Decode Decode 1	Protocol I2C	Signal	Configure	NextPage Page 1/3
Display Off	List	Format Hex	Copy Setting	NextPage Page 2/3
Tips Info On				NextPage Page 3/3

Figure 6.1 I2C Decode Menu

2. Press the **F1** softkey and select the desired slot (Decode1 or Decode2).
3. Press the **F2** softkey and then select I2C by turning the **Universal Knob**.
4. Press the **F3** softkey to enter the I2C signal menu.

SCL CH1	Threshold 0.00V	SDA CH2	Threshold 0.00V	←
------------	--------------------	------------	--------------------	---

Figure 6.2 I2C Signal Menu

5. Set SCL (I2C's clock signal):
 - a. Press the **F1** softkey to select the channel that is connected to the I2C clock signal.
 - b. Press the first **F2** softkey to set the I2C clock signal's threshold voltage level by Universal Knob.
 - The threshold voltage level is for decoding, and it will be regard as the trigger voltage level when set the trigger type to serial.
6. Set SDA (I2C's data signal):
 - a. Press the **F3** to select the channel that is connected to the I2C data signal.
 - b. Press the **F4** softkey to set the I2C data signal's threshold voltage level by Universal Knob.
 - The threshold voltage level is for decoding, and it will be regard as the trigger voltage level when set the trigger type to serial.

NOTICE

SDA should keep stable during the whole high clock cycle, otherwise it will be interpreted as a start or stop condition (data transitioning while the clock is high).

7. Press the  softkey to return to the previous menu.

6.1.2 I2C Trigger Conditions

After the oscilloscope has been set up to capture I2C signals, you can trigger on the following conditions:

- **Start**
- **Restart**
- **EEPROM**
- **10 Address & Data**
- **Stop**
- **No Ack**
- **7 Address & Data**
- **Data Length**

Start Condition

Triggers when the SDA data transitions from high to low while the SCL clock is high. For triggering purposes (including frame triggers), a restart is treated as a start condition.

Stop Condition

Triggers when the data (SDA) transitions from low to high while the clock (SCL) is high.

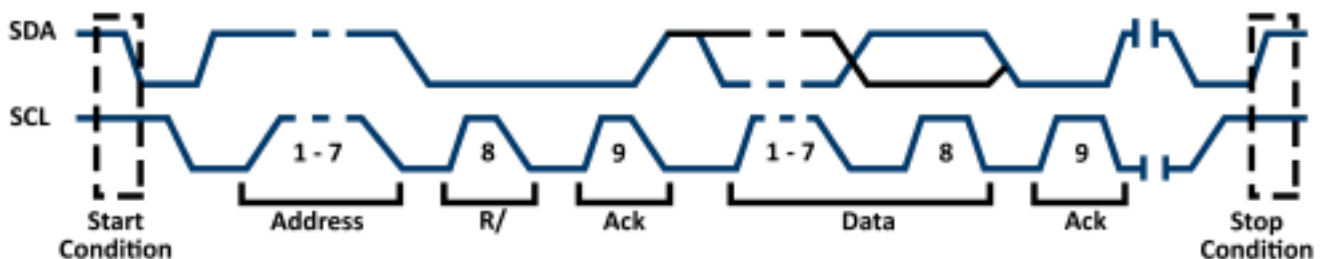

Figure 6.3 Start/Stop Conditions

Restart Condition

Triggers when another start condition occurs before a stop condition.

No Ack

Trigger when SDA data is high during any SCL's ACK bit.

EEPROM

The trigger looks for EEPROM control byte value 1010xxx on the SDA line, followed by a Read bit and an Ack bit. It then looks for the data value and qualifier set by the Data softkey and the Data is softkey. When this event occurs, the oscilloscope will trigger on the clock edge for the Ack bit after the data byte.

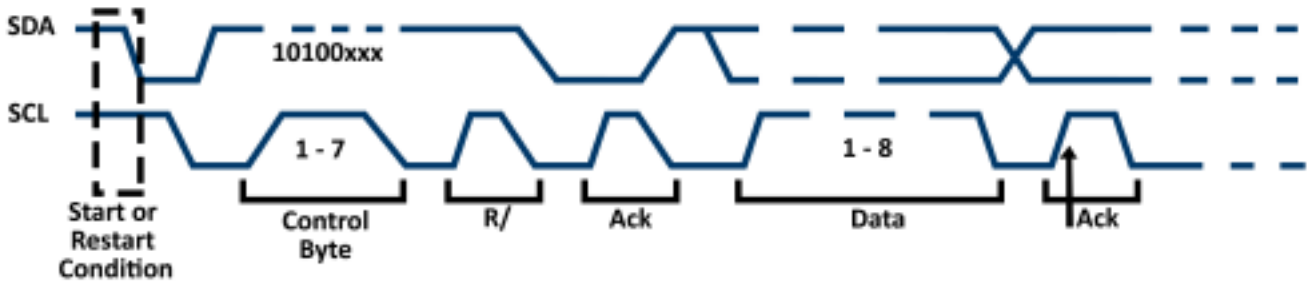

Figure 6.4 Restart, No Ack, and EEPROM Conditions

7 Address & Data

Triggers when the following conditions are satisfied:

- The address's length must be 7 bits and the address's value is the same as set value.
- If you have set either Data1's or Data2's value, and the signal has a data is the same as that value.
 - If you have set both Data1's and Data2's value, the signal should have two consecutive data, the first data's value is Data1, second data value is Data2.

NOTICE

If the data's value is 0xXX, any data value will be matched.

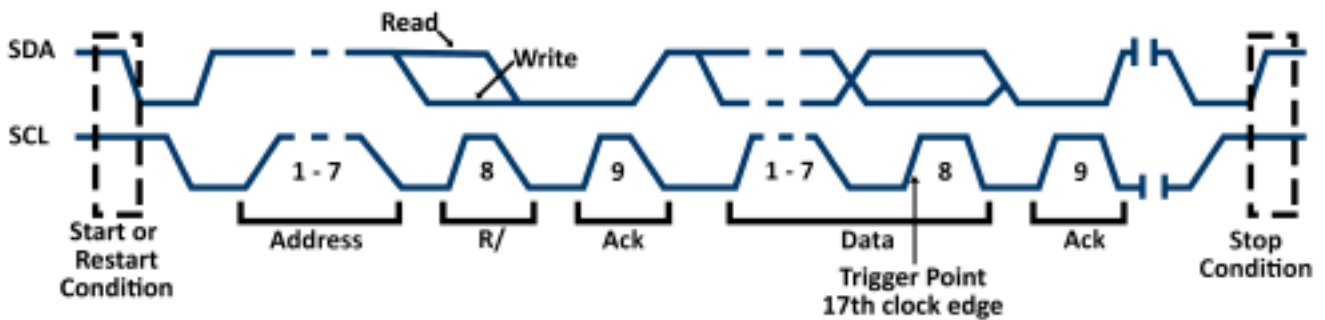

Figure 6.5 7 Address and Data

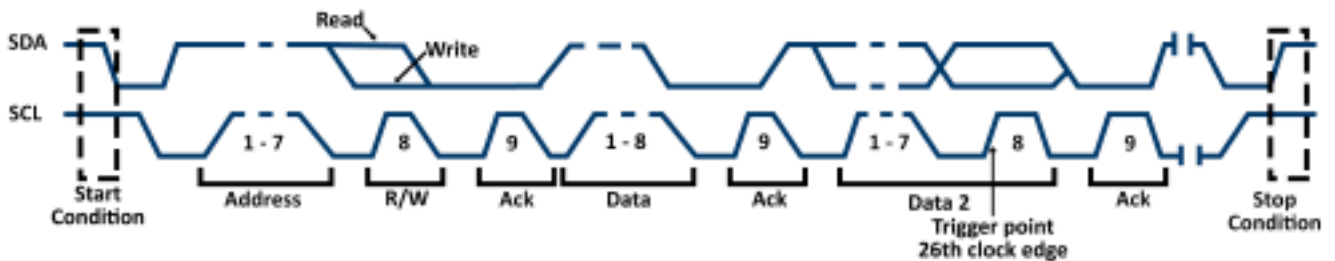

Figure 6.6 7 Address and Data2

10 Address & Data

Triggers when the following conditions are satisfied:

- The address's length must be 10 bits and the address's value is the same as set value.
- If you have set either Data1's or Data2's value, and the signal has a data is the same as that value.
 - If you have set both Data1's and Data2's value, the signal should has two consecutive data, the first data's value is Data1, second data value is Data2.

NOTICE

If the data's value is 0xXX, any data value will be matched.

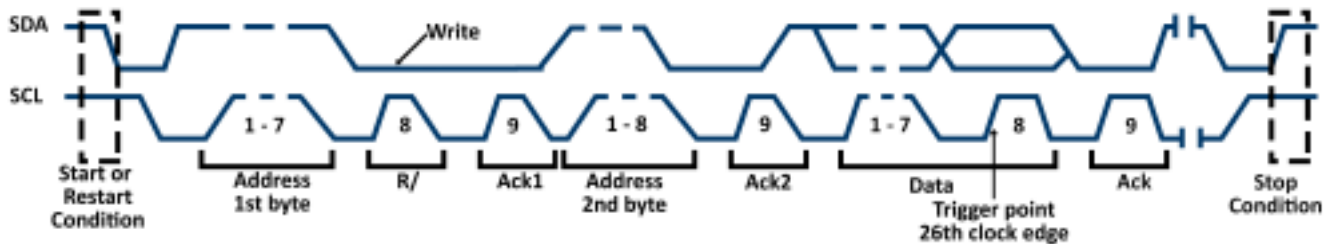











Figure 6.7 10 Address and Data

Data Length

Triggers when the SDA data's length is equal to the value of Byte Length and address's length is the same as set value. Byte length is in the range of 1 to 12 bits.

6.1.3 I2C Trigger Configuration

To configure a I2C trigger:

1. Press the  button to enter the **Trigger** menu.
2. Press the  softkey to select **Type**.
 - Use the **Universal Knob** to select **Serial**.
3. Press the  to select **Protocol**.
 - Use the **Universal Knob** to select **I2C**.
4. Press the  softkey to select **Trigger Setting**.
5. Press the  softkey to select **Condition Start**.
6. Use the **Universal Knob** to select the desired condition.
 - If you select the EEPROM condition:
 - Press the Limit Range softkey to set the qualifier (=, < or >).
 - Press the Data1 softkey and set its value by turning the **Universal Knob**.
 - If you select 7 Addr & Data or 10 Addr & Data condition:
 - Press the  softkey and turn the **Universal Knob** to select the 7-bit or 10-bit device address.
 - Press the  or  softkey and set the value about them.
 - Press the  to navigate to **Page 2/2**.
 - Press the  softkey to select the **R/W bit**.

NOTICE

If device address is 7-bit, the value of address is in range of 0x00 to 0x7F. If device's address is 10-bit, the value of address is in range of 0x00 to 0x3FF.

- If you select the Data Length condition:
 - Press the Address to set the SDA address length 7bit or 10 bit.
 - Press the Byte Length softkey and set the byte length by **Universal Knob**. The range of the Byte Length is 1 to 12.

6.1.4 I2C Serial Decode

After completing the setup of the I2C signal and trigger, we can proceed with decoding the I2C signals. The operation steps are as follows:

Step 1. Press the **Shift** then the **Decode Print** to enter the **Decode** menu.

Step 2. Press the **F1** softkey and select the desired slot (Decode1 or Decode2).

Step 3. Press the **F4** softkey to configure the Include R/W bit setting.

- Press the **F1** softkey to toggle the **Include R/W bit**, select **On**.

Step 4. Press the **F5** softkey to navigate to page 2/3 of the **Decode** menu.

Step 5. Press the **F1** softkey to toggle the **Display** state, select **On**.

Step 6. Press the **F3** softkey to configure the character encoding format of the decoding's results.

Step 7. Press the **F4** softkey to view the copy settings.

- The **COPY** function menu can be used to synchronize the corresponding bus configuration and trigger configuration.

Step 8. Press the **F2** softkey to enter the **List** menu.

- Press the **F1** softkey to toggle the **Display** state, select the Decode option selected on step 2.
- Press the **F2** softkey and turn the **Universal Knob** to view all frames.
- Press the **F3** softkey and turn the **Universal Knob** to specify the number of rows shown in the List (min. 1, max. 7).
- Press the **F4** softkey to toggle the **Long Data** display, select **On**.
- Press the **F5** softkey to navigate to page 2/2 of the **List** menu.
- Press the **F1** softkey open the file manager and save the list results.

6.1.5 Interpreting I2C Decode

The decoding result frames are presented as follows:

- The address value is displayed at the beginning of each frame.
- The write address is shown in green, while the read address is displayed in yellow.
- The W/R bit is represented by (W) for write and (R) for read, following the address value.
- The data value is shown in white.
- If there is no acknowledgement received for a particular data or address bit, it is indicated by "~A" appended after the corresponding bit.
 - For example, DB~A signifies a data bit without acknowledgement.
- In cases where there is insufficient space on the display to show the complete content of a frame, some of the content may be hidden, the indicator  will be provided.

The decoding list result are presented as follows:

- The horizontal displacement between current frame and trigger position is displayed in the 2nd column.
- The address of the frame is displayed on the 3rd column.
- The type of frame, read or write, is displayed on the 4th column.
- The last column displays the value of the data.

6.2 SPI Trigger and Serial Decode

6.2.1 SPI Setup

Setting the SPI (Serial Peripheral Interface) signal includes two steps: connecting the CLK, MISO, MOSI and CS signals to oscilloscope; specifying the parameters of each input signal.

1. Press the **Shift** then the **Decode Print** to enter the **Decode** menu.

Decode Decode 1	Protocol I2C	Signal	Configure	NextPage Page 1/3
Display Off	List	Format Hex	Copy Setting	NextPage Page 2/3
Tips Info On				NextPage Page 3/3

Figure 6.8 I2C Decode Menu

2. Press the **F1** softkey and select the desired slot (Decode1 or Decode2).
3. Press the **F2** softkey and then select **SPI** by turning the **Universal Knob**.
4. Press the **F3** softkey to enter the **SPI** signal menu.



Figure 6.9 SPI Signal Menu

5. Set CLK (clock signal):
 - a. Press the **F1** softkey to select the channel that is connected to the SPI clock signal.
 - b. Press the first **F2** softkey to set the SPI clock signal's threshold voltage level by Universal Knob.
 - The threshold voltage level is for decoding, and it will be regard as the trigger voltage level when set the trigger type to serial.
 - c. Press the first **F3** softkey to set the SPI clock triggering edge.
 - d. Press the first **F5** softkey to return to the **SPI** signal menu.
6. Set MISO:

- a. Press the **F1** and select the channel connected to the SPI MISO signal.
- b. Press the **F2** softkey to set the SPI data signal's threshold.
 - The threshold voltage level is for decoding, and it will be regard as the trigger voltage level when set the trigger type to serial.
- c. Press the first **F5** softkey to return to the **SPI** signal menu.

7. Set MOSI:

- a. Press the **F1** and select the channel connected to the SPI MOSI signal.
- b. Press the **F2** softkey to set the SPI data signal's threshold.
 - The threshold voltage level is for decoding, and it will be regard as the trigger voltage level when set the trigger type to serial.
- c. Press the first **F5** softkey to return to the **SPI** signal menu.

8. Set CS:

- a. Press the **F1** softkey to select the chip select type.
- b. Press the **F2** and select the channel connected to the SPI CS signal.
- c. Press the **F3** softkey to set the SPI data signal's threshold.
 - The threshold voltage level is for decoding, and it will be regard as the trigger voltage level when set the trigger type to serial.

CS Type	Description
~CS	low voltage level of CS signal is available
CS	high voltage level of CS signal is available.
CLK Timeout	If the time between two edges of clock signal is less than (or equal to) the timeout value, the signal between the two edges is treated as a frame. The range of clock timeout is 100ns-5ms. This setting is suitable for case where CS signal is not connected, or the number of oscilloscope channels is insufficient.

Table 6.1 CS Types

6.2.2 SPI Trigger

To Configure the SPI trigger:

Step 1. Press the  button to enter the **Trigger** function menu.

Step 2. Press the  softkey to select **Type**.

- Use the **Universal Knob** to select **Serial**.

Step 3. Press the  softkey to select **Protocol**.



- Use the **Universal Knob** to select **SPI**.

Step 4. Press the  softkey to enter the **Trigger Setting** menu.

- Press the  softkey to toggle between the available **Trigger Type**.

Trigger Type	Description
MISO	Master- In, Slave Out
MOSI	Master-Out, Slave-In

Table 6.2 SPI Trigger Type

- Press the  softkey to select **Data Length**.
 - Use the **Universal Knob** to set the length of the data.
 - The data length range can be set between 4 to 96 bits.
- Press the  softkey to select **Bit Pos..**
 - Use the **Universal Knob** to select a bit in data.
- Press the  softkey to assign a **Bit Value** to the selected.

Bit Value	Description
0	High voltage level
1	Low Voltage level
X	Don't care

Table 6.3 SPI Bit Value

- Press the **F4** softkey to select **Next Page**.
- To assign the same **Bit Value** to all bits press the **F3** softkey to select the value.
- Press the **F2** softkey to toggle between **LSB** and **MSB**.

6.2.3 SPI Serial Decode

After completing the setup of the SPI signal and trigger, proceed with decoding the SPI signal. The operation steps are as follows:

Step 1. Press the **Shift** then the **Decode/Print** to enter the **Decode** menu.

Step 2. Press the **F1** softkey and select the desired slot (Decode1 or Decode2).

Step 3. Press the **F4** softkey to enter the **Configure** menu.

- Press the **F1** softkey to toggle between **LSB** and **MSB**.
- Press the **F1** softkey to select **Data Length**.
 - Use the **Universal Knob** to set the data leng (4 - 32 bits).

Step 4. Press the **F5** softkey to navigate to page 2/3 of the **Decode** menu.

Step 5. Press the **F1** softkey to toggle the **Display** state, select **On**.

Step 6. Press the **F3** softkey to configure the character encoding format of the decoding's results.

Step 7. Press the **F4** softkey to view the copy settings.

- The **COPY** function menu can be used to synchronize the corresponding bus configuration and trigger configuration.

Step 8. Press the **F2** softkey to enter the **List** menu.

- Press the **F1** softkey to toggle the **Display** state, select the Decode option selected on step 2.
- Press the **F2** softkey and turn the **Universal Knob** to view all frames.
- Press the **F3** softkey and turn the **Universal Knob** to specify the number of rows shown in the List (min. 1, max. 7).

- Press the **F4** softkey to toggle the **Long Data** display, select **On**.
- Press the **F5** softkey to navigate to page 2/2 of the **List** menu.
- Press the **F1** softkey open the file manager and save the list results.

6.2.4 Interpreting SPI Decode

The decoding result frames are presented as follows:

- The data value are displayed in frames and are shown in white. Support 4 96 bit data display.
- **MISO**: The decoding result of “Master-In, Slave-Out” line.
- **MOSI**: The decoding result of “Master-Out, Slave-In” line.
- In cases where there is insufficient space on the display to show the complete content of a frame, some of the content may be hidden, the indicator  will be provided.

The decoding list result are presented as follows:

- **Time**: The horizontal displacement between current frame and trigger position.
- **MISO**: The decoding result of “Master-In, Slave-Out” line.
- **MOSI**: The decoding result of “Master-Out, Slave-In” line.

6.3 UART Trigger and Serial Decode

6.3.1 UART Setup

Setting the UART (Universal Asynchronous Receiver-Transmitter) signal includes two steps: configuring the UART Trigger, and specifying the parameters of each input signal **RX** and **TX**.

Step 1. Press the **Shift** then the **Decode Print** to enter the **Decode** menu.

Decode Decode 1	Protocol I2C	Signal	Configure	NextPage Page 1/3
Display Off	List	Format Hex	Copy Setting	NextPage Page 2/3
Tips Info On				NextPage Page 3/3

Figure 6.10 I2C Decode Menu

Step 2. Press the **F2** softkey and then select **UART** by turning the **Universal Knob**.

Step 3. Press the **F3** softkey to enter the **UART** signal menu.

RX CH1	Threshold 320mV	TX CH2	Threshold 180mV	←
-----------	--------------------	-----------	--------------------	---

Figure 6.11 UART Signal Menu

- Press the **F1** softkey to select the channel connected to the **RX** signal.
- Press the **F2** softkey to set the RX signal's threshold voltage level.
 - Use the **Universal Knob** to set the threshold voltage.
- Press the **F3** softkey to select the channel connected to the **TX** signal.
- Press the **F4** softkey to set the TX signal's threshold voltage level.
 - Use the **Universal Knob** to set the threshold voltage.
- Press the **F5** softkey to return to the previous menu.

Step 4. Press the **F4** softkey to enter the **Configure** menu.

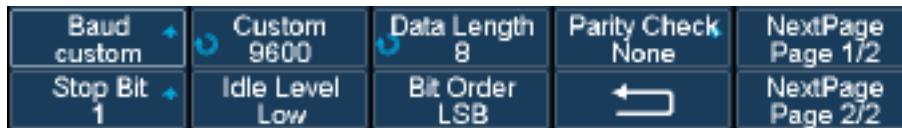



Figure 6.12 UART Config Menu

- a. Press the **F1** softkey to select **Baud**.
 - Use the **Universal Knob** to set the baud rate.
- b. Press the **F2** softkey to select **Custom** if **Baud** was set to custom.
 - Use the **Universal Knob** to set the baud rate or press the enter button to open the digital number pad.
- c. Press the **F3** softkey to select **Data Length**.
 - Use the **Universal Knob** to set the data length.
- d. Press the **F4** softkey to select **Parity Check**.
 - Use the **Universal Knob** to select the desired parity check.
- e. Press the **F5** softkey to navigate to page 2/2 of the **Config** menu.
- f. Press the **F1** softkey to select the **Stop Bit**.
- g. Press the **F2** softkey to toggle the **Idle Level** (Low or High).
- h. Press the **F3** softkey to toggle the **Bit Order** (LSB or MSB).

6.3.2 UART Trigger

To Configure the UART trigger:

Step 1. Press the  button to enter the **Trigger** function menu.



Step 2. Press the  softkey to select **Type**.

- Use the **Universal Knob** to select **Serial**.

Step 3. Press the  softkey to select **Protocol**.

- Use the **Universal Knob** to select **UART**.

Step 4. Press the  softkey to enter the **Trigger Setting** menu.

- Press the  softkey to select a **Source Type**.
- Press the  softkey to select a **Condition**.



Conditions	Description
Start	The oscilloscope will be triggered at the position of the start bit.
Stop	The oscilloscope will be triggered at the position of the stop bit.
Data	<p>The oscilloscope will be triggered when a byte is found; equal to ,greater than, or less than the specified data</p> <ul style="list-style-type: none"> • Press the  softkey to select a qualifier (>, <, or=). • Press the  softkey to set the data's value (0x00 to 0xff).
Error	If the parity check has been set, and the bit of parity check is error, the oscilloscope will be triggered.

Table 6.4 UART Conditions

6.3.3 UART Serial Decode

After completing the setup of the UART signal and trigger, proceed with decoding the UART signal. The operation steps are as follows:

Step 1. Press the **Shift** then the **Decode Print** to enter the **Decode** menu.

Step 2. Press the **F1** softkey and select the desired slot (Decode1 or Decode2).

Step 3. Press the **F4** softkey to enter the **Configure** menu.

- Refer to **UART Setup** to set up the UART parameters.

Step 4. Press the **F5** softkey to navigate to page 2/3 of the **Decode** menu.

Step 5. Press the **F1** softkey to toggle the **Display** state, select **On**.

Step 6. Press the **F3** softkey to configure the character encoding format of the decoding's results.

Step 7. Press the **F4** softkey to view the copy settings.

- The **COPY** function menu can be used to synchronize the corresponding bus configuration and trigger configuration.

Step 8. Press the **F2** softkey to enter the **List** menu.

- Press the **F1** softkey to toggle the **Display** state, select the Decode option selected on step 2.
- Press the **F2** softkey and turn the **Universal Knob** to view all frames.
- Press the **F3** softkey and turn the **Universal Knob** to specify the number of rows shown in the List (min. 1, max. 7).
- Press the **F4** softkey to toggle the **Long Data** display, select **On**.
- Press the **F5** softkey to navigate to page 2/2 of the **List** menu.
- Press the **F1** softkey open the file manager and save the list results.

6.3.4 Interpreting UART Decode

The decoding result frames are presented as follows:

- The data value are displayed in frames and are shown in white. Support 4 96 bit data display.
- **RX:** The decoding results of the data received.
- **TX:** The decoding result of the data transmitted.
- In cases where there is insufficient space on the display to show the complete content of a frame, some of the content may be hidden, the indicator  will be provided.

The decoding list result are presented as follows:

- **Time:** The horizontal displacement between current frame and trigger position.
- **RX:** The receiving channel.
- **TX:** The transmitting channel.
- **RX Err:** Parity error or unknown error in the data received.
- **TX Err:** Parity error or unknown error in the data transmitted.

6.4 CAN Trigger and Serial Decode

6.4.1 CAN Setup

To setup CAN decoding follow the steps below:

Step 1. Press the **Shift** then the **Decode Print** to enter the **Decode** menu.

Step 2. Press the **F2** softkey and then select **CAN** by turning the **Universal Knob**.

Step 3. Press the **F3** softkey to enter the **CAN** signal menu.



Figure 6.13 CAN Signal Menu

- a. Press the **F3** softkey to select the **Source**.
 - Press the softkey corresponding to the selected source in order to configure the source parameters (channel and threshold).
- b. Press the **F2** softkey to set the signal's threshold voltage level.
 - Use the **Universal Knob** to set the threshold voltage.
- c. Press the **F5** softkey to return to the previous menu.

Step 4. Press the **F4** softkey to enter the **Configure** menu.



Figure 6.14 CAN Config Menu

- a. Press the **F1** softkey to select **Baud**.
 - Use the **Universal Knob** to set the baud rate.
- b. Press the **F2** softkey to select **Custom** if **Baud** was set to custom.
 - Use the **Universal Knob** to set the baud rate or press the enter button to open the digital number pad.

6.4.2 CAN Trigger

To Configure the CAN trigger:

Step 1. Press the  button to enter the **Trigger** function menu.

Step 2. Press the  softkey to select **Type**.

- Use the **Universal Knob** to select **Serial**.

Step 3. Press the  softkey to select **Protocol**.

- Use the **Universal Knob** to select **CAN**.

Step 4. Press the  softkey to enter the **Trigger Setting** menu.



Figure 6.15 CAN Trigger Menu

- Press the  softkey to select a **Condition**.

Step 5. If **Remote**, **ID**, or **ID + Data** condition was selected:

- Press the  softkey

- Use the **Universal Knob** to set the ID's value.

- Press the  softkey set the length of ID (11bits or 29 bits).

- Press the  softkey and use the Universal Knob to select the byte that you want to set.

- For **ID + Data** press the  softkey to view the second menu page.

- Press the  softkey and use the **Universal Knob** to set the value of the first byte.

NOTICE

In order to make it convenient for the operation, ID is split into several bytes. For example, if the ID's length is 11 bits, it will be split into two bytes, a byte includes 8 bits. If "1st byte" is selected, only the 8 least significant bits can be changed.

6.4.3 CAN Serial Decode

After completing the setup of the CAN signal and trigger, proceed with decoding the CAN signal. The operation steps are as follows:

Step 1. Press the **Shift** then the **Decode/Print** to enter the **Decode** menu.

Step 2. Press the **F1** softkey and select the desired slot (Decode1 or Decode2).

Step 3. Press the **F5** softkey to navigate to page 2/3 of the **Decode** menu.

Step 4. Press the **F1** softkey to toggle the **Display** state, select **On**.

Step 5. Press the **F3** softkey to configure the character encoding format of the decoding's results.

Step 6. Press the **F4** softkey to view the copy settings.

- The **COPY** function menu can be used to synchronize the corresponding bus configuration and trigger configuration.

Step 7. Press the **F2** softkey to enter the **List** menu.

- Press the **F1** softkey to toggle the **Display** state, select the Decode option selected on step 2.
- Press the **F2** softkey and turn the **Universal Knob** to view all frames.
- Press the **F3** softkey and turn the **Universal Knob** to specify the number of rows shown in the List (min. 1, max. 7).
- Press the **F4** softkey to toggle the **Long Data** display, select **On**.
- Press the **F5** softkey to navigate to page 2/2 of the **List** menu.
- Press the **F1** softkey open the file manager and save the list results.

The decoding result frames are presented as follows:

- Arbitration field is displayed in frame
- Control field is displayed in frame
- Data field is displayed in frame
- CRC field is displayed in frame
- In cases where there is insufficient space on the display to show the complete content of a frame, some of the content may be hidden, the indicator  will be provided.

The decoding list result are presented as follows:

- **Time:** The horizontal displacement between current frame and trigger position.
- **Type:** The type of frames, “D” represents data frame, “R” represents remote frame.
- **ID:** The ID of frames, the oscilloscope can automatically detect the length of frame’s id (11 bits or 27 bits).
- **Length:** The length of the data field.
- **Data:** The value of the data field.
- **CRC:** The value of CRC (Cyclic Redundancy Check) field.
- **ACK:** Acknowledgement bit.

6.5 LIN Trigger and Serial Decode

6.5.1 LIN Setup

To setup LIN decoding follow the steps below:

Step 1. Press the **Shift** then the **Decode Print** to enter the **Decode** menu.

Step 2. Press the **F2** softkey and then select **LIN** by turning the **Universal Knob**.

Step 3. Press the **F3** softkey to enter the **LIN** signal menu.



Figure 6.16 LIN Signal Menu

- a. Press the **F1** softkey to select the **Source**.
- b. Press the **F2** softkey to set the signal's threshold voltage level.
 - Use the **Universal Knob** to set the threshold voltage.
- c. Press the **F5** softkey to return to the previous menu.

Step 4. Press the **F4** softkey to enter the **Configure** menu.

- a. Press the **F1** softkey to select **Baud**.
 - Use the **Universal Knob** to set the baud rate.
- b. Press the **F2** softkey to select **Custom** if **Baud** was set to custom.
 - Use the **Universal Knob** to set the baud rate or press the enter button to open the digital number pad.

6.5.2 LIN Trigger

To Configure the LIN trigger:

Step 1. Press the **Trigger Setup** button to enter the **Trigger** function menu.

Step 2. Press the **F1** softkey to select **Type**.

- Use the **Universal Knob** to select **Serial**.

Step 3. Press the **F2** softkey to select **Protocol**.

- Use the **Universal Knob** to select **LIN**.

Step 4. Press the **F4** softkey to enter the **Trigger Setting** menu.

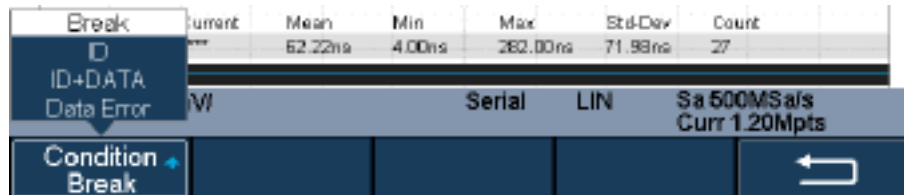

Figure 6.17 LIN Trigger Menu

a. Press the **F1** softkey to select a **Condition**.

Step 5. If the **ID** condition was selected:

a. Press the **F1** softkey

- Use the **Universal Knob** to set the ID's value.

b. If the **ID + Data** condition was selected:

a. Press the **F1** softkey

- Use the **Universal Knob** to set the ID's value.

b. Press the **F2** softkey to select **Data1**.

- Use the **Universal Knob** to set the Data1's value.

c. Press the **F3** softkey to select **Data2**.

- Use the **Universal Knob** to set the Data2's value.

6.5.3 CAN Serial Decode

After completing the setup of the CAN signal and trigger, proceed with decoding the CAN signal. The operation steps are as follows:

Step 1. Press the  then the  to enter the **Decode** menu.

Step 2. Press the  softkey and select the desired slot (Decode1 or Decode2).

Step 3. Press the  softkey to navigate to page 2/3 of the **Decode** menu.







Step 4. Press the  softkey to toggle the **Display** state, select **On**.

Step 5. Press the  softkey to configure the character encoding format of the decoding's results.

Step 6. Press the  softkey to view the copy settings.

- The **COPY** function menu can be used to synchronize the corresponding bus configuration and trigger configuration.

Step 7. Press the  softkey to enter the **List** menu.

- Press the  softkey to toggle the **Display** state, select the Decode option selected on step 2.
- Press the  softkey and turn the **Universal Knob** to view all frames.
- Press the  softkey and turn the **Universal Knob** to specify the number of rows shown in the List (min. 1, max. 7).
- Press the  softkey to toggle the **Long Data** display, select **On**.
- Press the  softkey to navigate to page 2/2 of the **List** menu.
- Press the  softkey open the file manager and save the list results.

The decoding result frames are presented as follows:

- Protected Identifier Field is displayed in frame
- Data Length is displayed in frame
- Data Field is displayed in frame.
- Checksum Field is displayed in frame.
- In cases where there is insufficient space on the display to show the complete content of a frame, some of the content may be hidden, the indicator  will be provided.

The decoding list result are presented as follows:

- **Time:** The horizontal displacement between current frame and trigger position.
- **ID:** The value of frame's Protected Identifier Field.
- **Data Length:** The length of the data field.
- **ID Parity:** The two check bits of Protected Identifier Field.
- **Data:** The value of Data Field.
- **Checksum:** The value of Checksum Field.

Reference Waveform

Analog channel or math waveforms can be saved to one of two reference waveform locations in the oscilloscope. Then, reference waveforms can be displayed and compared against other waveforms. Both reference waveforms can be displayed at a time.

7.1	Saving a Reference	108
7.2	Display a Reference Waveform	109
7.3	Adjust Reference Waveform	109
7.4	Clear Reference Waveform	110

7.1 Saving a Reference

To save a waveform to a reference waveform location:

1. Press the **Shift** and then the **Ref Menu On/Off** button on the front panel to enter the **Reference Waveform** menu.

NOTICE

When the horizontal format is set to **X-Y**, the REF function cannot be enabled.

2. Press the **F1** softkey to select **Source**.
 - A dropdown menu containing the available options will appear.

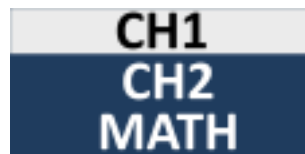

Figure 7.1 Available Options

3. Use the **Universal Knob** to navigate the available options.
 - Repeatedly pressing **F4** will navigate between the available choices.
4. Press the **F2** softkey to toggle between **REF A** and **REF B** saving positions.
5. Press the **F3** softkey to save the channel or math waveform to the appointed location.
 - The message “**Saved to internal file REF***” will appear when the waveform has been saved successfully.





The vertical scale information and the vertical offset of the waveform will be saved at the same time.

NOTICE

The REF waveforms are non-volatile. The REF waveform can still be saved after restarts or default operation.







7.2 Display a Reference Waveform

To display a saved reference waveform:

1. Press the  and then the  button on the front panel to enter the **Reference Waveform** menu.
2. Press the  softkey to toggle between **REF A** and **REF B** positions.
 - Select the **Location** of the reference waveform to be displayed.
3. Press the  softkey to display the selected reference waveform.

7.3 Adjust Reference Waveform

To adjust the reference waveform:

1. Press the  and then the  button on the front panel to enter the **Reference Waveform** menu.
2. Press the  softkey to toggle between **REF A** and **REF B** positions.
 - Select the **Location** of the reference waveform to be displayed.
3. Press the  softkey to display the selected reference waveform.
4. Press the  softkey to navigate to **Page 2/2**.
5. Press the  softkey to select **Scale**.
 - Use the **Universal Knob** to adjust the scale.
6. Press the  softkey to select **Position**.
 - Use the **Universal Knob** to adjust the position.

NOTICE

The initial values display at the middle of the screen is the setup when the reference waveform is saved.

7.4 Clear Reference Waveform

The oscilloscope does not have a “Clear” option under the REF WAVE function menu.

To clear the appointed reference waveform, you can save a new reference waveform to the same location to replace it. Or press **Shift** + **Save/Recall Cursors** → **F2** → **F1** → **F4** and select Security Erase to clear the stored waveform.

Math

The oscilloscope supports math operations and math transforms.

Math operators perform arithmetic operations (like add, subtract, or multiply) on analog input channels.

Math transforms perform a transform function (like differentiate, integrate, FFT, or square root) on an analog input channel or on the result of an arithmetic operation.

Math function waveforms are displayed in shades of light purple and labeled with **"M"**

8.1	Selecting a Math Function	112
8.2	Add or Subtract	112
8.3	Multiply or Divide	113
8.4	Differentiate	113
8.5	Integrate	114
8.6	Square Root	114
8.7	FFT Operation	115

NOTICE

If the analog channel or the math function is cut off (waveforms do not display on the screen completely), the resulting math will also be cut off.

8.1 Selecting a Math Function

To select a math function:

1. Press the **Shift** and then the **Math Measure** button to enter the **Math** menu.
2. Press the **F2** and then the **F3** softkey to select the **Source A** and **Source B** respectively.
 - A dropdown menu containing the available options will appear.

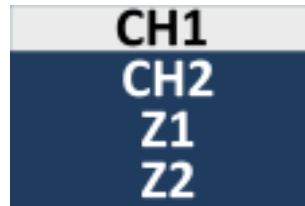

Figure 8.1 Available Sources

3. Use the **Universal Knob** to navigate the available options.
 - Repeatedly pressing **F4** will navigate between the available choices.
4. Press the **F1** to select **Operator**.
 - A dropdown menu containing the available options will appear.
 - Use the **Universal Knob** to navigate the available options.

8.2 Add or Subtract

Math operators perform arithmetic operations, add or subtract, on any two analog input channels. When you select addition or subtraction, the Source A and Source B values are added or subtracted point by point, and the result is displayed.

You can use subtract to make a differential measurement or to compare two waveforms.

If the waveforms' DC offsets are larger than the dynamic range of the oscilloscope's input channels you will need to use a differential probe instead.

8.3 Multiply or Divide

When you select the multiply or divide math function, the **Source A** and **Source B** values are multiplied or divided point by point, and the result is displayed.

The divide by zero case places holes (that is, zero values) in the output waveform.

Multiply is useful for seeing power relationships when one of the channels is proportional to the current.

8.4 Differentiate

d/dt (differentiate) calculates the discrete time derivative of the selected source.

Differentiate can be used to measure the instantaneous slope of a waveform. For example, the slew rate of an operational amplifier may be measured using the differentiate function.

Because differentiation is very sensitive to noise, it is helpful to set acquisition mode to Averaging (see [Selecting the Acquisition Mode](#)). d/dt plots the derivative of the selected source using the "average slope estimate at 4 points" formula. The equation is:

$$d_i = \frac{y_{i+4} + 2y_{i-2} - 2y_{i-2} - y_{i-4}}{8\Delta t}$$

Where:

- **d** = differential waveform.
- **y** = channel 1, 2, or Math 1, Math 2 (lower math function) data points.
- **i** = data point index.
- **Δt** = point-to-point time difference.

8.5 Integrate

$\int dt$ (integrate) calculates the integral of the selected source. It shows the accumulated amount of change.

Use integrate to calculate the energy of a pulse in volt-seconds or measure the area under a waveform by measuring the difference in the integrate function value across the pulse or waveform.

$\int dt$ plots the integral of the source using the "Trapezoidal Rule". The equation is:

$$I_n = c_0 + \Delta t \sum_{i=0}^n y_i$$

Where:

- I = integrated waveform
- Δt = point- to- point time difference
- y = channel 1, 2, 3, or 4 data points
- c_o = arbitrary constant
- i = data point index

The integrate operator provides an Offset softkey that lets you enter a DC offset correction factor for the input signal. Small DC offset in the integrate function input (or even small oscilloscope calibration errors) can cause the integrate function output to "ramp" up or down. This DC offset correction lets you level the integrate waveform.

8.6 Square Root

Square root ($\sqrt{\quad}$) calculates the square root of the selected source.

Where the transform is undefined for a particular input, holes (zero values) appear in the function output.

8.7 FFT Operation

The source of the FFT math functions can be analog input channels or a lower math function.

FFT is used to compute the fast Fourier transform using analog input channels. FFT takes the digitized time record of the specified source and transforms it to the frequency domain. When the FFT function is selected, the FFT spectrum is plotted on the oscilloscope display as magnitude in dBV versus frequency. The readout for the horizontal axis changes from time to frequency (Hertz) and the vertical readout changes from V to dB.

Use the FFT function to: find crosstalk problems, to find distortion problems in analog waveforms caused by amplifier non-linearity, measure harmonic components and distortion in the device under test, measure the characteristics of the noise in DC power, analyze vibration, or for adjusting analog filters.

Display FFT Waveform

To display a FFT waveform:

1. Press the **Shift** and then the **Math Measure** button to enter the **Math** menu.
2. Press the **F1** to select **Operator**.
3. Use the **Universal Knob** to navigate the available option and select **FFT**.
 - The resulting math waveform is displayed in white and labeled as "**M**".
4. Press the **F2** softkey to toggle the source between **CH1** and **CH2**.
5. Press the **F3** softkey to enter the **Config** menu.

Maximum points 1M	Window Hanning	AUTO SET	Display Split Screen	NextPage Page 1/2
Mode Normal			←	NextPage Page 2/2

Figure 8.2 Config Menu

- Press the **F1** softkey to select **Window**.
 - A dropdown menu containing the available options will appear.



Figure 8.3 Window Option

- Use the **Universal Knob** to navigate the available options.
 - Repeatedly pressing **F4** will navigate between the available choices.

Spectral leakage can be considerably decreased when a window function is used. The oscilloscope provides five windows (Rectangle, Blackman, Hanning, Hamming and Flattop) which have different characteristics and are applicable to measure different waveforms. Select the window function according to different waveforms and their characteristics. Please read the table below carefully to make an appropriate option according to the input signal.

Window	Description
Rectangular	Window for good frequency resolution and amplitude accuracy, but use only where there will be no leakage effects. Use on self-windowing waveforms such as pseudo-random noise, impulses, sine bursts, and decaying sinusoids.
Blackman	Window reduces time resolution compared to a rectangular window, but improves the capacity to detect smaller impulses due to lower secondary lobes.
Hanning	Window for making accurate frequency measurements or for resolving two frequencies that are close together.
Hamming	Window for reducing leakage and improving amplitude accuracy, but reduces frequency resolution.
Flat Top	Window for making accurate amplitude measurements of frequency peaks.

Table 8.1 Windows

- Press the **F3** softkey to automatically set the appropriate parameters for the FFT measurement.
- Press the **F4** softkey to select **Display**.
 - A dropdown menu containing the available options will appear.



Figure 8.4 Display Options

- Use the **Universal Knob** to navigate the available options.
 - Repeatedly pressing **F4** will navigate between the available choices.

Window	Description
Split Screen	Time domain waveform and frequency domain waveform are displayed separately. The time domain waveform is on the upper half screen, while the frequency domain waveform is located within the lower half of the display. In Split mode, if Zoom is enabled, the zoom waveform and the frequency domain waveform are displayed on the lower half screen together.
Full Screen	Time-domain waveform and frequency-domain waveform are displayed together.
Exclusive	Only the frequency-domain waveform is displayed.

Table 8.2 Display

- Press the **F5** softkey to navigate to **Page 2/2**.
- In **Page 2/2** press the **F1** softkey to select **Mode**.
 - A dropdown menu containing the available options will appear.
- Use the **Universal Knob** to navigate the available options.
 - Repeatedly pressing **F4** will navigate between the available choices.
- If **Average** is selected the sample size (**Times**) must be specified.

6. Return to the **Math** menu, **Page 1/2**.
7. Press the **F4** softkey to enter the **Vertical** menu.



Figure 8.5 Vertical Menu

- Press the **F1** softkey to select **Scale**,
 - Turn the **Universal Knob** to select the desired vertical FFT scale.
 - Press the **F2** softkey to select **Ref Level**.
 - Turn the **Universal Knob** to select the desired vertical FFT offset.
 - Press the **F3** softkey to select the unit of vertical axis.
 - The vertical axis units can be set to dBVrms, dBm, Vrms or dBArms, Arms, which use a logarithmic scale or a linear scale to display vertical amplitude respectively.
 - Press the **F4** softkey to select **Ext Load**.
 - Turn the **Universal Knob** to set the desired external load.
8. Return to the **Math** menu, and navigate to **Page 2/2** by pressing the **F5** softkey.
 9. Press the **F1** softkey to enter the **Horizontal** menu.



Figure 8.6 Horizontal Menu

- Press the **F4** softkey to select **Center**.
 - Turn the **Universal Knob** to select the desired center frequency.
 - Press the **F2** softkey to select **Span**.
 - Turn the **Universal Knob** to select the desired span frequency.
10. Return to the **Math** menu, and navigate to **Page 2/2**.

11. Press the **F2** softkey to enter the **Tools** menu.
12. Press the **F1** softkey to select **Type**.
 - A dropdown menu containing the available options will appear.



Figure 8.7 Type Options

13. Use the **Universal Knob** to navigate the available options.
 - Repeatedly pressing **F4** will navigate between the available choices.

NOTICE

The **Tools** menu will differ based on the type selected.

Peak Type

When Peak type is selected the peaks of the current FFT waveform will automatically be marked based on the search configuration.

Type	Show Table	Show Frequency	Sort By	NextPage
Peaks	Off	Off	Amplitude	Page 1/2
Search Config				←

Figure 8.8 Tools Peaks Menu

- Press the **F2** table to toggle the peak table **On** or **Off**.
- Press the **F3** to toggle the display of the frequency for each peak on the peak table.
 - **Show Table** must be enabled to view show frequency.
- Press the **F4** to toggle the peak table sorting between **Amplitude** and **Frequency**.
- Press the **F5** softkey to navigate to **Page 2/2** of the Tools menu.

- Press the **F1** softkey enter the **Search Config** menu.



Figure 8.9 Peak Search Config Menu

- Press the **F1** softkey to select **Threshold**.
 - Turn the **Universal Knob** to set the minimum peak amplitude.
 - Only peaks larger than the peak limit can be judged as peaks.
- Press the **F2** softkey to select **Excursion**.
 - Turn the **Universal Knob** to set the difference between the peak value and the minimum amplitude on both sides..
 - Only when the difference is greater than the peak value of peak offset can the peak value be determined.

Marker Type

When Markers type is selected the user can customize the marker locations on the FFT waveform based on search configuration.

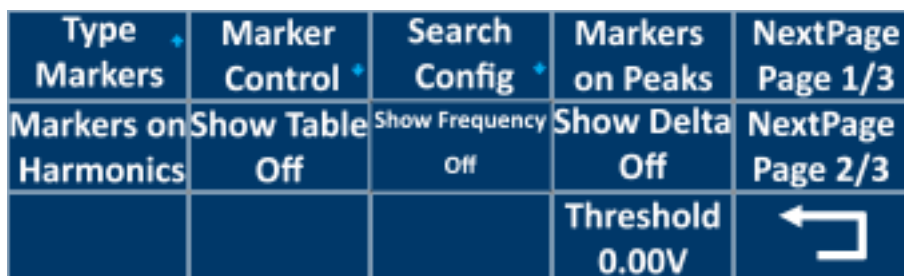

Figure 8.10 Markers Type Menu

- Press the **F2** softkey to enter the **Marker Control** menu.



Figure 8.11 Markers Control Menu

- Press the **F1** softkey continuously to select the marker number from NO.1 to NO.8
- Press the **F2** softkey continuously to turn on or off the selected mark.

- Press the **F3** softkey to select **Frequency**.
 - Turn the **Universal Knob** to set the desired frequency.
- Press the **F4** softkey to move the selected marker to the next peak.
- Press the **F5** softkey to navigate to **Page 2/2**.
- Press the **F1** softkey to move the selected marker to the next peak with lower amplitude.
 - Up to 20 peaks are supported.
- Press the **F4** softkey in **Page 2/2** to return to the **Markers Type Menu**.
- Press the **F3** softkey to enter the **Markers Search Config Menu**.



Figure 8.12 Markers Search Config Menu

- Press the **F1** softkey to select **Threshold**.
 - Turn the **Universal Knob** to set the minimum peak amplitude.
 - Only peaks larger than the peak limit can be judged as peaks.
- Press the **F2** softkey to select **Excursion**.
 - Turn the **Universal Knob** to set the difference between the peak value and the minimum amplitude on both sides..
 - Only when the difference is greater than the peak value of peak offset can the peak value be determined.
- Press the **F5** softkey to return to the **Markers Type Menu**.
- Press the **F4** softkey to to set the markers on peaks.
- Press the **F5** softkey to navigate to **Page 2/3** of the **Markers Type Menu**.
- Press the **F1** softkey to set the markers on harmonics.
- Press the **F2** softkey to toggle the marker table.
- Press the **F3** softkey to toggle the frequency column in the marker table.
- Press the **F4** softkey to toggle the delta columns on the marker table.

Cursors

Cursors are horizontal and vertical markers that indicate X-axis values and Y-axis values on a selected waveform source. You can use cursors to make custom voltage, time, phase, or ratio measurements on oscilloscope signals.

Cursor information is displayed in the left-upper-side of the display.

9.1 X Cursors

X cursors are vertical dashed lines that adjust horizontally and can be used to measure time (when the source is FFT waveform, X cursors measure frequency).

X1 cursor is the left (default position) vertical dotted line; it can be moved to any place of the screen.

X2 cursor is the right (default position) vertical dotted line; it can be moved to any place of the screen.

Use the **Universal Knob** to set the X1 and X2 cursor values and the values are displayed in the cursors box in the upper-left corner of the screen along with the difference between X1 and X2 (ΔT) and $1/\Delta T$.

When set cursor type to X2-X1, use Universal Knob will move the X1 and X2 cursors together. The value under the menu option is the difference between the X1 and X2 cursors.

9.2 Y Cursors

Y cursors are horizontal dotted lines that adjust vertically. They can be used to measure voltage (V) or current (A). When the cursors source is the math function, the unit will match the math function.

Y cursors are horizontal dotted lines that adjust vertically and can be used to measure voltage (V) or current (A). When the cursors source is the math function, the unit will match the math function.

Y1 cursor is the top (default position) horizontal dotted line; it can be moved to any vertical place of the screen.

Y2 cursor is the down (default position) horizontal dotted line; it can be moved to any vertical place of the screen.

Use the **Universal Knob** to set the Y1 and Y2 cursor values and the values are displayed in the cursors box in the top left corner of the screen along with the difference between Y1 and Y2 (ΔY).

When set cursor type to Y2-Y1, use **Universal Knob** will move the Y1 and Y2 cursors together. The value under the menu option is the difference between the Y1 and Y2 cursors.

9.3 Cursor Measurements

To make measurements using the cursors:

Step 1. Press the  button on the front panel to enter the **CURSOR** function menu.

Step 2. Press the  softkey to configure the cursor mode.

- **Manual:** ΔX , $1/\Delta X$, and ΔY values are displayed. ΔX is the difference between the X1 and X2 cursors and ΔY is the difference between the Y1 and Y2 cursors.
- **Track:** As the marker is moved horizontally, the vertical amplitude of the waveform is tracked and measured. The time and voltage positions are shown for the markers. The vertical (Y) and horizontal (X) differences between the markers are shown as ΔX and ΔY values.

NOTICE

Manual and **Track** modes can be used on waveforms that are displayed on the analog input channels (including math functions)

Step 3. Press the **Source** (or **X1 Source**, **X2 Source** in **Track** mode) softkey, then use the **Universal Knob** to select the input source for the cursor values.

- Only analog channels, math waveforms and reference waveforms that are displayed are available for cursors.

Step 4. Press the **X Ref** and **Y Ref** softkeys to set the reference of the X and Y cursors.

Step 5. To make cursor measurements:

- To measure the horizontal time, use the **Universal Knob** to move the X1 and X2 cursors to desired location. If necessary, set the cursor type to X2-X1 to move X1 and X2 cursors together.
- To measure vertical voltage or current, use the **Universal Knob** to move the Y1 and Y2 cursors to desired location. If necessary, set the cursor type to “Y2-Y1” to move Y1 and Y2 cursors together.
- To adjust the transparency of the cursors message box, press the  button and go to the second page, then press the **Transparency** (20% to 80%) softkey and then turn the **Universal Knob** to adjust the transparency to the desired value.

Measure

The **Measure** menu allows the user to make automatic measurements on waveforms. The oscilloscope provides measurements of 38 waveform's parameters and statistics. Some measurements only be made on analog input channels.

10.1	Type of Measurements	125
10.1.1	Voltage Mesasurements	126
10.1.2	Time Measurements	128
10.1.3	Delay Measurements	129
10.2	Add a Measurement	130
10.3	Clear Measurement	131
10.4	All Measurement	131
10.5	Gate Measurement	132

10.1 Type of Measurements

The oscilloscope provides measurements of voltage, time, and delay parameters.

Voltage and time parameters are under the **Type** option. Delay parameters are under the **All Measure** submenu. Set the Delay option to **On** to display all the delay parameters.

The results of up to 5 measurements are displayed above the channel info tab when **Statistics** is enabled. The results of the last four selected measurements are displayed above the channel info tab when **Statistics** is disabled.

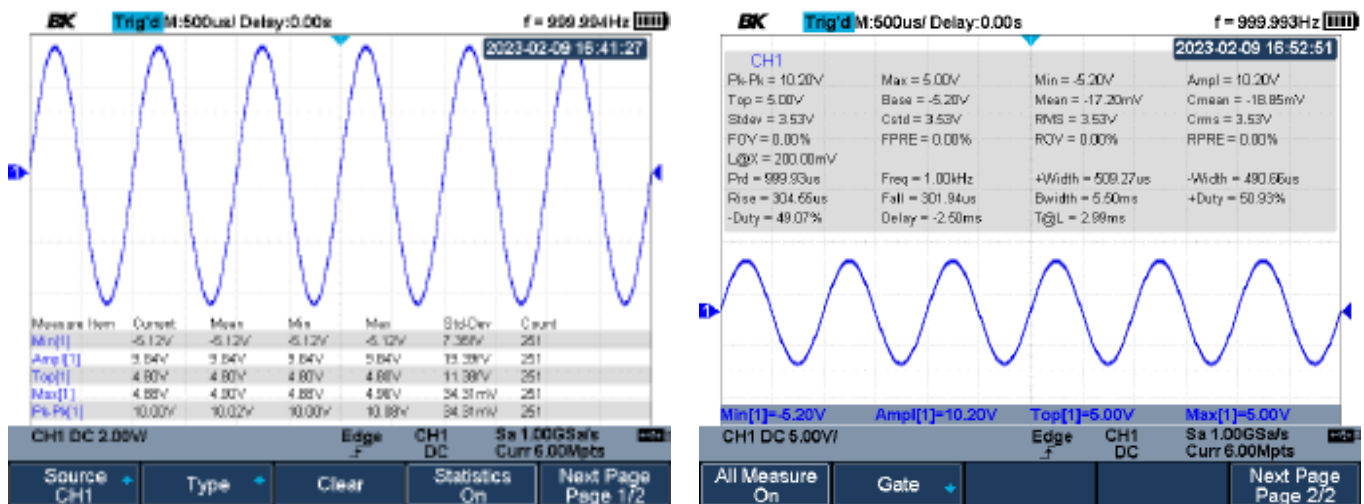

Statistics Enable

All Measure Enable

Figure 10.1 Measurements View

NOTICE

In addition to changing display parameters after the acquisition, you can perform all of the measurements and math functions after the acquisition. Measurements and math functions will be recalculated as you pan and zoom and turn channels on and off. As you zoom in and out on a signal, the resolution of the display is affected. Because measurements and math functions are performed on displayed data, the resolution of functions and measurements are affected.

10.1.1 Voltage Measurements

Voltage measurements include 17 kinds of voltage parameters.

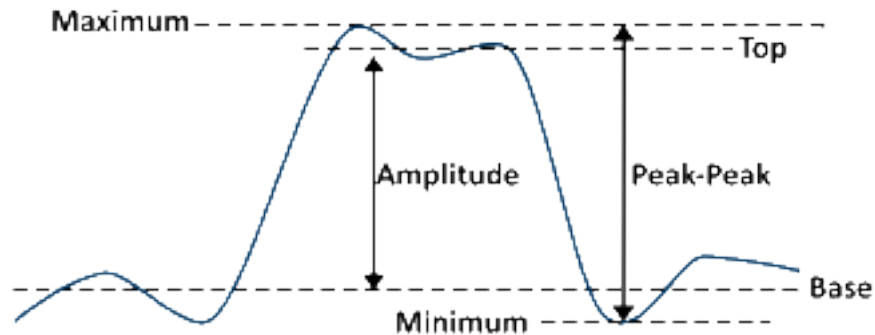

Figure 10.2 Voltage Measurements

Peak-Peak: The difference between maximum and minimum data values.

Maximum: The highest value in the waveform display.

Minimum: The lowest values in the waveform display.

Amplitude: The difference between the top and base value of the waveform.

Top: The most common value of the upper part of the waveform, or if the mode is not well defined, the top value is the same as the maximum value.

Base: The most common value of the lower part of the waveform. If the mode is not well defined, the base value is the same as the minimum value.

Mean: The sum of the level of the waveform's samples divided by the number of cycles.

Cycle Mean: The sum of the level of the waveform's first sample divided by the number of cycles.

Stdev: The standard deviation of all the waveform's cycles.

Cycle Stdev: The standard deviation of all the values in the waveform's first cycle.

RMS: The root-mean-square of the waveform over one or more full cycle.

Cycle RMS: The root-mean-square of the waveform's first cycle.

Overshoot: The distortion that follows a major edge transition expressed as a percentage of Amplitude. The X cursors show which edge is being measured (edge closest to the trigger reference point).

$$\text{Rising edge overshoot} = \frac{\text{local Maximum} - D \text{ Top}}{\text{Amplitude}} \times 100$$

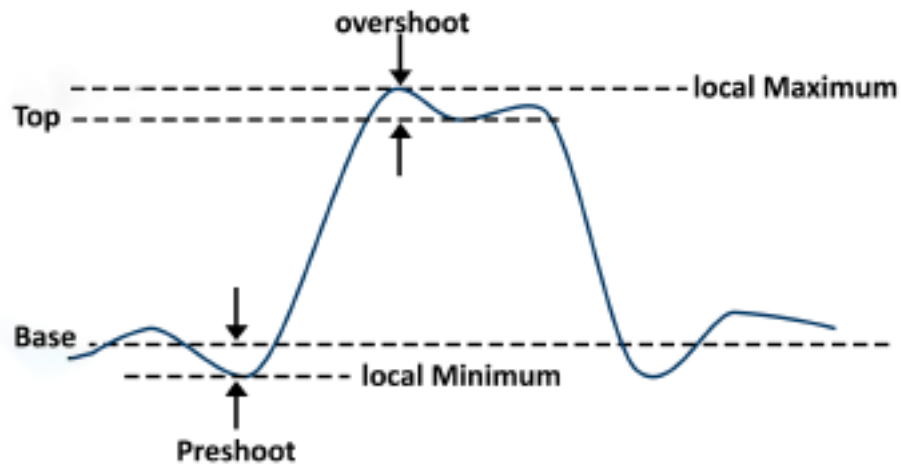

Figure 10.3 Overshoot and Preshoot

$$\text{Falling edge overshoot} = \frac{\text{Base} - D \text{ local Minimum}}{\text{Amplitude}} \times 100$$

Preshoot The distortion that precedes a major edge transition expressed as a percentage of Amplitude.

$$\text{Rising edge preshoot} = \frac{\text{local Maximum} - D \text{ Top}}{\text{Amplitude}} \times 100$$

$$\text{Falling edge preshoot} = \frac{\text{Base} - D \text{ local Minimum}}{\text{Amplitude}} \times 100$$

Level@X The voltage value between the trigger point and the vertical position of the channel.

10.1.2 Time Measurements

Time measurements include 11 kinds of time parameters.

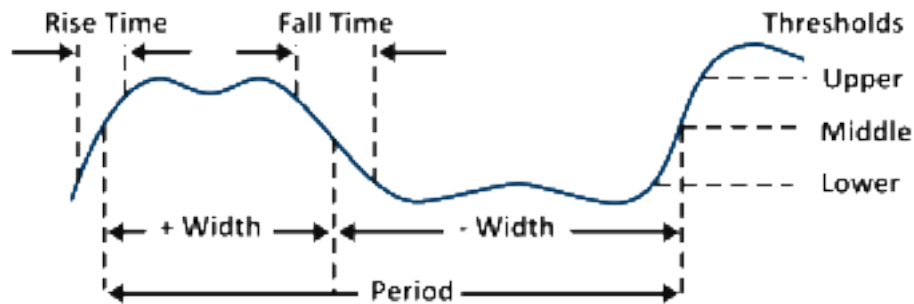

Figure 10.4 Time Measurements

Period The time period of the complete waveform cycle. The time is measured between the middle threshold points of two consecutive, like-polarity edges. A middle threshold crossing must also travel through the lower and upper threshold levels which eliminates runt pulses. The **X** cursors show what portion of the waveform is being measured. The **Y** cursor shows the middle threshold point.

Frequency Frequency is defined as $1 / \text{Period}$.

+ Width The time from the middle threshold of the rising edge to the middle threshold of the next falling edge.

- Width The time from the middle threshold of the falling edge to the middle threshold of the next rising edge.

Rise Time Duration of rising edge from 20 to 90 %.

Falling Time The duration of falling edge from 90 to 10 %.

Bwid The time from the first rising edge to the last falling edge, or the first falling edge to the last rising edge at the 50% crossing.

+ Duty The ratio of positive width to period.

- Duty The ratio of negative width to period.

Delay The time difference between two waveform edges using the specified threshold points of the waveform.

T@L The tie from the trigger to the first transition at a specific level and slope, include: Current, Max, Min, Mean, and Std-dev.

10.1.3 Delay Measurements

The delay measurements measure the time difference between two channels. 10 type of delay measurements are supported.

Phase: Calculates the phase difference between two edges.

FRFR: The time between the first rising edges of the two channels.

FRFF: The time from the first rising edge of channel A to the first falling edge of channel B.

FFFR: The time from the first falling edge of channel A to the first rising edge of channel B.

FFFF: The time from the first falling edge of channel A to the first falling edge of channel B.

FRLR: The time from the first rising edge of channel A to the last rising edge of channel B.

FRLF: The time from the first rising edge of channel A to the last falling edge of channel B.

FFLR: The time from the first falling edge of channel A to the last rising edge of channel B.

FFLF: The time from the first falling edge of channel A to the last falling edge of channel B.

Skew: The time of source A edge minus time of the nearest source B edge.

10.2 Add a Measurement

Perform the steps below to add a measurement.

NOTICE

Only 5 measurements can be selected at once.

Step 1. Press the  button on the front panel to enter the **MEASURE** function menu.

- The frequency and period measurements will be enabled with the current trigger channel.

Step 2. Press the  softkey, and then use the **Universal Knob** to select the desired channel. Only analog channels that are displayed are available.

Step 3. To select and display a measurement, press the  softkey, and then turn the **Universal Knob** to select the desired measurement.

- Press the **Universal Knob** to add the measurement.

Step 4. To toggle the statistic function press the **Statistics** softkey.



Figure 10.5 Add a Measurement

NOTICE

If the parameter does not match the measure condition, the measurement will display "*****"

10.3 Clear Measurement

To clear all the selected measurements:

Step 1. Press the **Measure** key to enter the **MEASURE** menu.

Step 2. Press the **F3** to select **Clear**.

10.4 All Measurement

The **All Measure** option displays all the voltage and time parameter of the selected.

To enable **All Measure**:

Step 1. Press the **Measure** key to enter the **MEASURE** menu.

Step 2. Press the **F1** softkey to select the desire source.

Step 3. Press the **F5** softkey to navigate to page **2/2** of the **MEASURE** menu.

Step 4. Press the **F1** softkey to toggle **All Measure**.

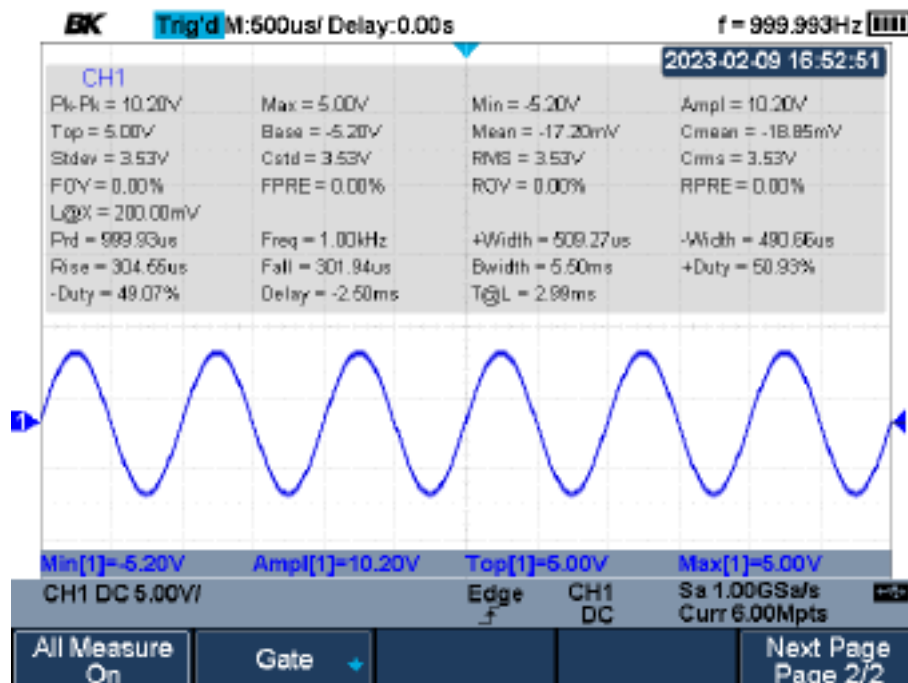









Figure 10.6 All Measure Enable

10.5 Gate Measurement

Gate measurement performs the selected measurements within the upper and lower limits of the gate. Setting the gate will affect the measurement of all voltage, time, and delay parameters.

To enable gated measurements:

- Step 1.** Press the  key to enter the **MEASURE** menu.
- Step 2.** Press the  softkey to navigate to page **2/2** of the **MEASURE** menu.
- Step 3.** Press the  softkey to enter the **Gate** submenu.
- Step 4.** Press the  softkey to toggle the gate.
- Step 5.** Press the  softkey and use the **Universal Knob** to set the position of gate A.
- Step 6.** Press the  softkey and use the **Universal Knob** to set the position of gate B.
- Step 7.** Press the  softkey and use the **Universal Knob** to simultaneously adjust the position of both gate A and gate B.

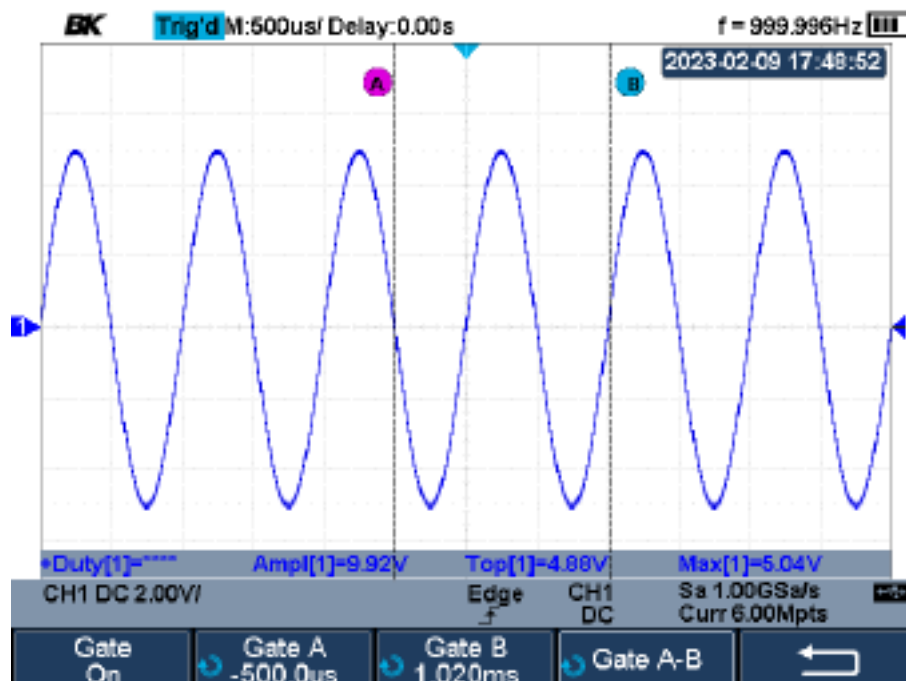

Figure 10.7 Gate Measurements

Display

The instrument's display type, color, persistence, grid type, waveform intensity, grid brightness, and transparency can be adjusted.

11.1	Display Type	134
11.2	Color Grade	135
11.3	Persistence	136
11.4	Clear Display	136
11.5	Grid Type	137
11.6	Intensity	137
11.7	Transparence	138
11.8	LCD Light	138

11.1 Display Type

The 2510B series supports vector and dots display types. The oscilloscope is designed to operate optimally with vectors (connect the dots) on. This mode produces the most insightful waveforms for most situations.

Vectors: The sample points are connected by lines and displayed. Normally, this mode can provide the most vivid waveform to view the step edge of the waveform (such as square waveform).

Vectors give an analog look to a digitized waveform, and allow subtle detail of complex waveforms to be viewed, even when the detail is just a small number of pixels in size.

Dots: The sample points are directly displayed. Each sample point can be viewed directly and the cursors can be used to measure the X and Y values of the sample point.

Use dots when highly complex or multivalued waveforms are displayed. Dots may aid the display of multivalued waveforms such as eye diagrams.

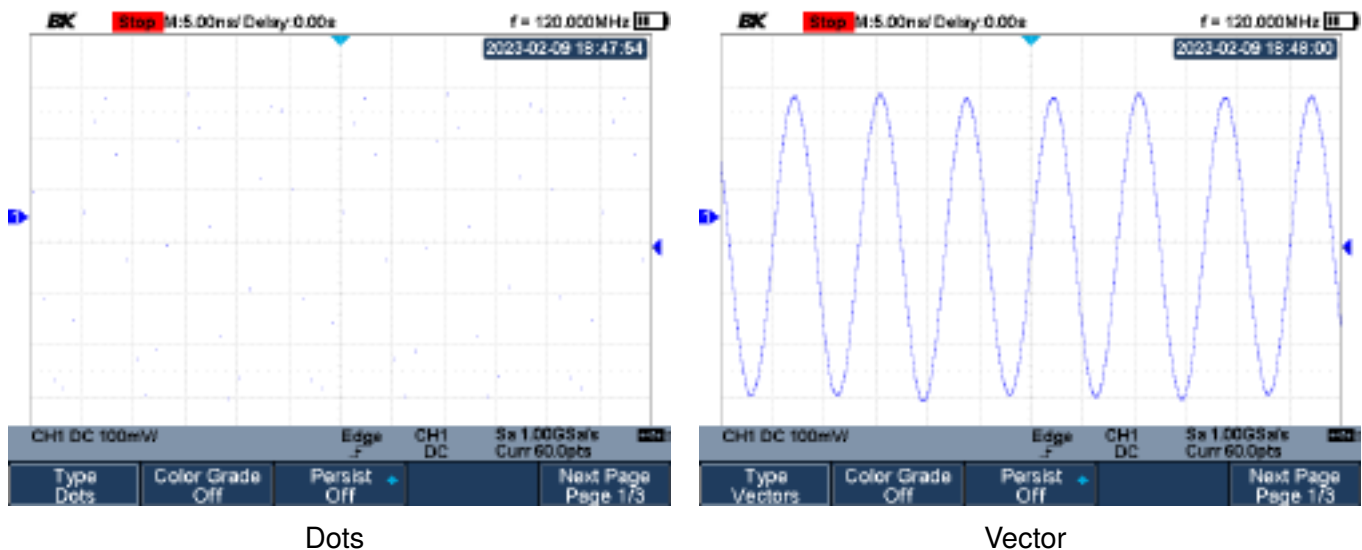



Figure 11.1 Display Type

To change the display type:

Step 1. Press the  key to enter the **Display** menu.

Step 2. Press the  softkey to toggle between **Vector** and **Dots**.

11.2 Color Grade

Color temperature adopts the change of waveforms' color to reflect the change of the waveforms' appearing probability. The greater the probability that the waveform appears, the warmer the color is; the smaller the waveform appears, the colder the color is.

To change the display type:

Step 1. Press the  key to enter the **Display** menu.

Step 2. Press the  softkey to toggle color grade.

Figure 11.2 shows the change of color from cold to warm.

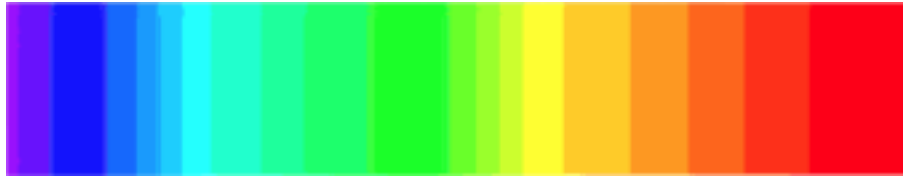

Figure 11.2 Color Temperature

11.3 Persistence

With persistence enabled, the oscilloscope updates the display with new acquisitions, but does not immediately erase the results of previous acquisitions. All previous acquisitions are displayed with reduced intensity. New acquisitions are shown in their normal color with normal intensity.

NOTICE

Waveform persistence is kept only for the current display area; you cannot pan and zoom the persistence display.

To enable persistence:

Step 1. Press the  key to enter the **Display** menu.

Step 2. Press the  softkey to select the persistence type.

- Turn the **Universal Knob** to select the persistence type:

OFF: Turns off persistence.

Time: Results of previous acquisitions are erased after a certain amount of time (1 second, 5 seconds, 10 seconds, 30 seconds). Time persistence provides a view of acquired data that is similar to analog oscilloscopes.

Infinite: Results of previous acquisitions are never erased. Use infinite persistence to measure noise and jitter, see the worst-case extremes of varying waveforms, look for timing violations, or capture events that occur infrequently.

Step 3. When the Persist is On, press the Clear Persist softkey to erase the results of previous acquisitions from the display. The oscilloscope will start to accumulate acquisitions again.

Step 4. To return to the normal display mode, turn off persist and the previous acquisitions will be clear at once

11.4 Clear Display

To clear all waveforms displayed on the screen and acquire and display new waveforms:

Step 1. Press the  key to enter the **DISPLAY** menu.

Step 2. Press the  softkey to navigate to page 2/3 of the **DISPLAY** menu.

Step 3. Press the  softkey to clear all waveforms.

11.5 Grid Type

The oscilloscope provides 3 kinds of grid types:

- 12 × 8 grid type
- 2 × 2 grid type
- Display without grid

To select grid type:

Step 1. Press the  key to enter the **DISPLAY** menu.

Step 2. Press the  softkey to navigate to page **2/3** of the **DISPLAY** menu.

Step 3. Press the  softkey to view the available grid types.

- Use the **Universal Knob** to select the desired grid type.

Step 4. Press the  softkey to configure the visibility of the graticule.

11.6 Intensity

Increasing the intensity lets you see the maximum amount of noise and infrequently occurring events. Reducing the intensity can expose more detail in complex signals as shown in the following figures.

NOTICE

Waveform intensity adjustment affects analog channel waveforms only. Math, reference, and digital waveforms are not affected.

To configure the intensity value:

Step 1. Press the  key to enter the **DISPLAY** menu.

Step 2. Press the  softkey to navigate to page **2/3** of the **DISPLAY** menu.

Step 3. Press the  softkey to modify the intensity value.

- Use the **Universal Knob** to configure the intensity value.

11.7 Transparency

Transparence can be used to adjust the transparence of the message box, cursor, measure, Pass/Fail and all pop-up menus boxes.

To change the transparency:

Step 1. Press the  key to enter the **DISPLAY** menu.

Step 2. Press the  softkey twice to navigate to page **3/3** of the **DISPLAY** menu.

Step 3. Press the  softkey to modify the Transparency value.

- Use the **Universal Knob** to configure the transparency value.

NOTICE

The transparency value is configurable range is 20% to 80%.

11.8 LCD Light

To adjust the LCD light brightness:

Step 1. Press the  key to enter the **DISPLAY** menu.

Step 2. Press the  softkey twice to navigate to page **3/3** of the **DISPLAY** menu.

Step 3. Press the  softkey to modify the brightness percentage.

- Use the **Universal Knob** to configure the brightness.

Save and Recall

The oscilloscope setups, waveforms, pictures, and CSV files can be saved to the internal memory or to a USB storage device. The saved setups, waveforms can be recalled later. The oscilloscope provides a USB Host interface on the right side panel to connect a USB device for external storage.

12.1	Save Types	139
12.2	Save and Recall a File	141
12.3	Save File	141
12.4	Recall File	142
12.5	File Manager	143
12.5.1	Create a New File or Folder	143
12.5.2	Delete a File or Folder	144
12.5.3	Rename a File or Folder	144
12.5.4	Copy a File or Folder	144
12.5.5	Cut a File or Folder	145

12.1 Save Types

The oscilloscope supports setups, waveforms, images and CSV files storage. The default save type is setups.

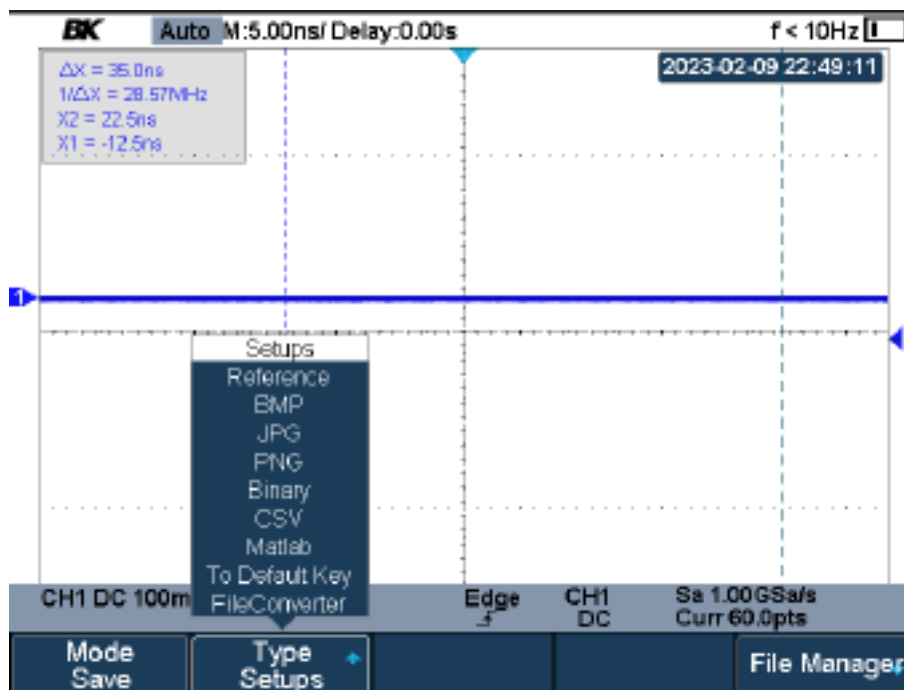

Figure 12.1 Files Types

Setups: It's the default storage type of the oscilloscope. It saves the settings of the oscilloscope in internal or external memory in "*.xml" format. The stored settings can be recalled.

Reference: The oscilloscope saves the waveform data in "*.REF" format. The data of the channel is your select channel. At recall, the data will be displayed on the screen by REFA or REFB.

BMP: The oscilloscope saves the screen image in "*.bmp" format. You can specify the file name and saving directory under the same directory using the same file name. The recall of an image is not supported.

JPG: The oscilloscope saves the screen image in "*.jpg" format. You can specify the file name and saving directory under the same directory using the same file name. The recall of an image is not supported.

PNG: The oscilloscope saves the screen image in "*.png" format. You can specify the file name and saving directory under the same directory using the same file name. The recall of an image is not supported.

Binary: The oscilloscope saves the waveform data in "*.BIN" format. The data of all the channels turned on can be saved in the same file. The recall of binary is not supported.

CSV: The oscilloscope saves the waveform data in "*.CSV" format. The stored files contain the waveform data of the displayed analog channels and the main setting information of the oscilloscope. The recall of CSV file is not supported.

Set the save type to CSV, and set the Param Save option to On or Off to turn on the parameters storage function.

Matlab: The oscilloscope saves the waveform data in "*.DAT" format. The data of all the channels turned on can be saved in the same file. The recall of Matlab file is not supported.

To Default Key: The oscilloscope saves the factory config and user set config. Then you can select the default function is the factory config or user set config.

FileConverter: The mini tool converts stored binary files to CSV format for viewing with a spreadsheet program. It supports for file of waveform data (*.bin), file of sample logger(*.slg) and file of measure logger (*.mlg) to convert.

This is ideal when collecting large datasets. For a waveform frame with deep memory such as 12 Mpts, to save directly as a CSV file will take long time and will occupy a large amount of memory on a USB storage device. It's recommended to save the data as binary file and then convert it to CSV file on a computer.



12.2 Save and Recall a File

The Oscilloscope can store files to the internal memory or to external USB storage device. External storage supports all the save types of files. Images and CSV are not supported for recall.

To save it externally, insert the USB flash drive into the USB Host interface of the side panel. If the USB flash drive is successfully identified, message "USB flash drive detected".

12.3 Save File

To save a file:

Step 1. Press the  and  key to enter the **SAVE/RECALL** menu.

Step 2. Press the  softkey to toggle between **Save** and **Load** mode.

Step 3. Press the  softkey to view the available Type setups files.

- Use the **Universal Knob** to select the save file type.

Step 4. Press the  softkey to enter the file manage interface.

- Use the **Universal Knob** to select the file path.

Step 5. Press the  softkey to enter the file manage interface.

Step 6. Press the  softkey to save the file.

- When the save type is "To Default Key", press the  softkey to select "Current Setup" or "Factory Setup", and then press the Press to Save softkey to save

12.4 Recall File

To save a file:

Step 1. Press the  and  key to enter the **SAVE/RECALL** menu.

Step 2. Press the  softkey to toggle between **Save** and **Load** mode.

Step 3. Press the  softkey to view the available Type setups files.

- Use the **Universal Knob** to select the recall file type.

Step 4. Press the  softkey to enter the file manage interface.

- Use the **Universal Knob** to select the file path.

Step 5. Press the  softkey to enter the file manage interface.

Step 6. Press the  softkey to recall the file.

- The format of the selected file should be consistent with the recall type. Otherwise, it will pop-up the prompt “**File format is illegal!**”.
- The pop-up the message “**Recalled file successfully!**” will appear once the file is recalled.
- When the recall type is “**Factory Default**”, the pop up message “**Factory default setting recalled**” will be displayed.
- When the recall type is “**Security Erase**”, the pop up message “**Factory default setting recalled**” will be displayed.

12.5 File Manager

In addition to save and recall files, the file manager also supports the operations of creating, deleting, renaming, copying, cutting and pasting files.

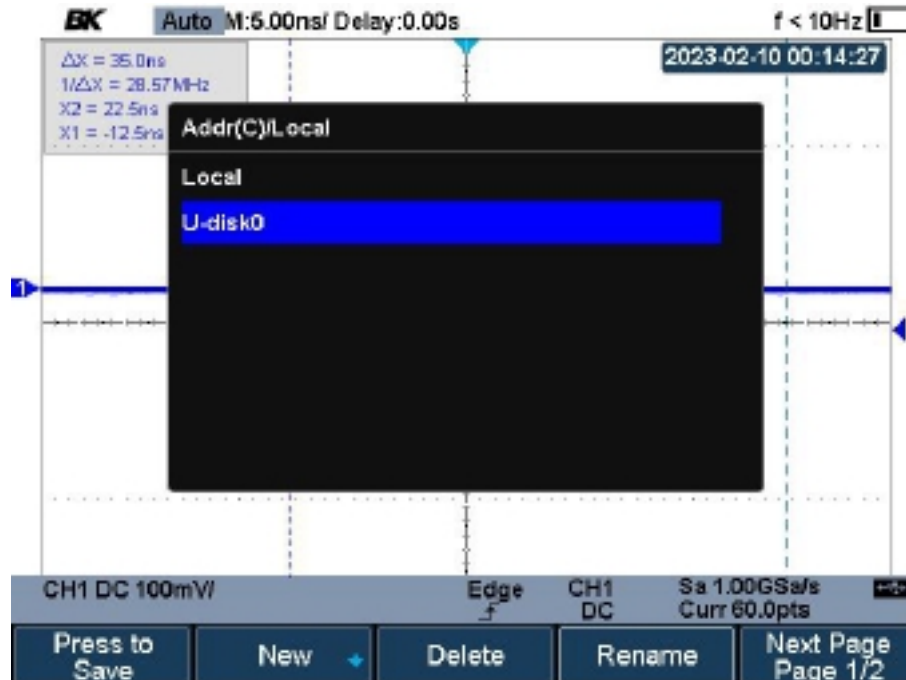

Figure 12.2 File Manager

12.5.1 Create a New File or Folder



The file or folder name can contain letters, numbers, underscores, and spaces.

To create a new file or folder:

- Step 1.** Press the **Shift** and **Save/Recall Cursors** key to enter the **SAVE/RECALL** menu.
- Step 2.** Press the **F5** softkey to enter the file manager.
- Step 3.** Press the **F2** softkey to configure a new file/folder.
- Step 4.** Press the **F1** softkey to create a new folder or press the **F2** softkey to create a new file.
 - Use the **Universal Knob** to input the name of the new file/folder.
- Step 5.** Press the **F4** softkey to save the new file/folder.





12.5.2 Delete a File or Folder

To delete a file/folder:

- Step 1.** Press the  and  key to enter the **SAVE/RECALL** menu.
- Step 2.** Use the **Universal Knob** to navigate to the file/folder that will be deleted.
- Step 3.** Press the  softkey to delete the selected file/folder.





12.5.3 Rename a File or Folder

To rename a file/folder:

- Step 1.** Press the  and  key to enter the **SAVE/RECALL** menu.
- Step 2.** Use the **Universal Knob** to navigate to the file/folder that will be renamed.
- Step 3.** Press the  softkey to delete the selected file/folder.
 - Use the **Universal Knob** to input the new name.
- Step 4.** Press the  to save the file under the new name.





12.5.4 Copy a File or Folder

To copy a file/folder:

- Step 1.** Press the  and  key to enter the **SAVE/RECALL** menu.
- Step 2.** Use the **Universal Knob** to navigate to the file/folder that will be copied.
- Step 3.** Press the  to navigate to page **page 2/2** of the **SAVE/RECALL** menu.
- Step 4.** Press the  softkey to copy the selected file/folder.
- Step 5.** Use the **Universal Knob** to navigate to the file path where you want to paste the copied file to.
- Step 6.** Press the  softkey to paste the selected file/folder.

12.5.5 Cut a File or Folder

To cut a file/folder:

- Step 1.** Press the  and  key to enter the **SAVE/RECALL** menu.
- Step 2.** Use the **Universal Knob** to navigate to the file/folder that will be cut.
- Step 3.** Press the  to navigate to page **page 2/2** of the **SAVE/RECALL** menu.
- Step 4.** Press the  softkey to cut the selected file/folder.
- Step 5.** Use the **Universal Knob** to navigate to the file path where you want to paste the copied file to.
- Step 6.** Press the  softkey and the file will be cut successfully and the source file is deleted.

NOTICE

When renaming or copying a file, if there is a file with the same name under the target directory, the file will be directly overwritten.

System Settings

The system settings supports the oscilloscope's system-related functions, such as system status, language, sound, self-cal, update, and remote interface configuration.

13.1	View System Status	147
13.2	Self Cal	148
13.3	Quick-Cal	149
13.4	Sound	149
13.5	Language	149
13.6	Update Firmware and Configuration	150
13.6.1	Update Firmware	150
13.6.2	Update Configure	151
13.7	Self Test	152
13.7.1	Screen Test	152
13.7.2	Keyboard Test	153
13.7.3	LED Test	154
13.8	Screen Saver	155
13.9	Date and Time	155
13.9.1	Set Date	155
13.9.2	Set Time	156
13.9.3	Set Zone	156
13.10	Reference Position	157

13.1 View System Status

To view the system status:

- Step 1.** Press the **Utility** key to enter the **SETTINGS** menu.
- Step 2.** Press the **F1** softkey to view the system status.
- Step 3.** Press the **F5** softkey to exit the system status page.

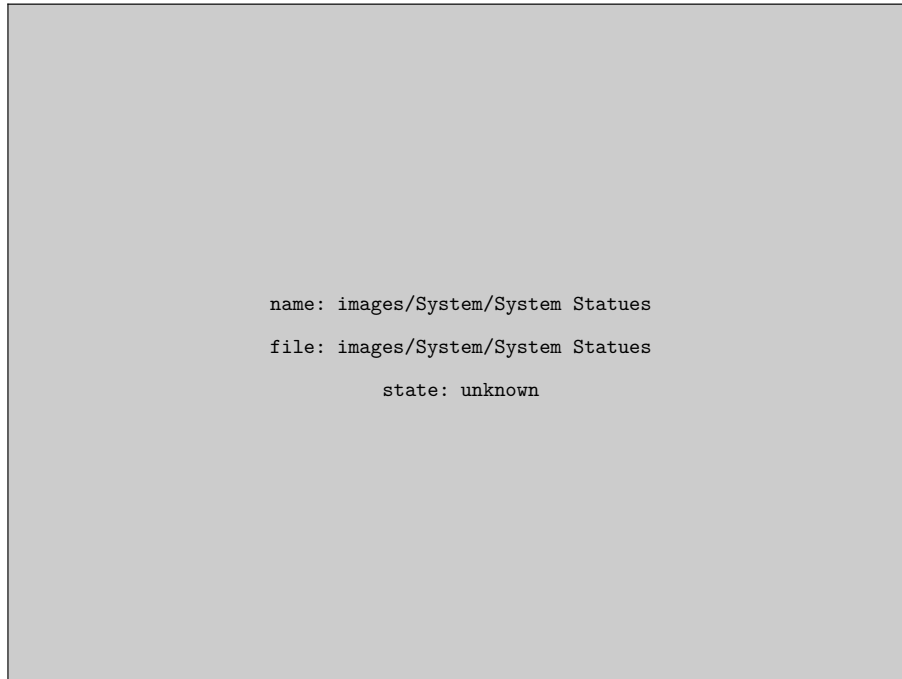

Figure 13.1 System Status

The system status includes the information below:

- Startup Times:** Displays the number of boot up times of the oscilloscope.
- Software Version:** Displays the current software version of the oscilloscope.
- Uboot-OS Version:** Displays the current Uboot and OS version of the oscilloscope.
- FPGA Version:** Displays the current fpga version of the oscilloscope.
- Hardware Version:** Displays the current hardware version of the oscilloscope.
- Product Type:** Displays the product type of the oscilloscope.
- Serial No.:** Displays the serial number of the oscilloscope.

13.2 Self Cal

The self-calibration program can quickly make the oscilloscope reach the best working state to get the most precise measurement values. You can perform the self-calibration at any time, especially when the environment temperature change is up to or more than 5 °C. Ensure that the oscilloscope has been warmed up or operated for more than 30 minutes before performing a self-calibration.

To perform a self-calibration:

Step 1. Disconnect all the input channels.

Step 2. Press the **Utility** key to enter the **SETTINGS** menu.

Step 3. Press the **F5** softkey to navigate to page **2/3** of the **SETTINGS** menu.

Step 4. Press the **F2** softkey to enter the self-calibration notice.

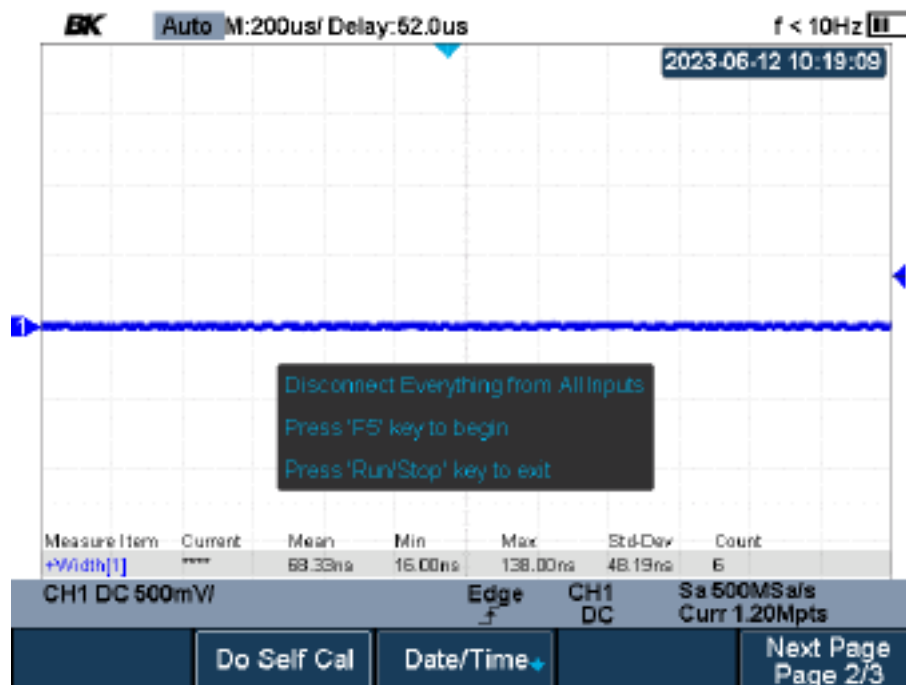

Figure 13.2 Do Self Cal

Step 5. Press the **F5** softkey to begin the self-calibration.

- During calibration most of the keys are disabled.
- Once the self-calibration is complete, the message **"Press Run/Stop to exit"** will appear.

Step 6. Press the **Run/Stop** button to exit the calibration interface.

13.3 Quick-Cal

Quick calibration can correct the measurement deviation caused by temperature to get more accurate measurements.

If the ambient temperature of oscilloscope is unstable:

Step 1. Press the  key to enter the **SETTINGS** menu.

Step 2. Press the  softkey to enable quick calibration.

13.4 Sound

The sound setting modifies the state of the beeper. When sound is enabled, pressing a function key or a softkey will sound the beeper. The beeper will also beep when a prompt message pops up.

To enable/disable the beeper:

Step 1. Press the  key to enter the **SETTINGS** menu.

Step 2. Press the  softkey to toggle the beeper state.

13.5 Language

The oscilloscope's; menu, help, and prompt messages are available in English and Chinese.

English, Simplified Chinese, Traditional Chinese, French, German, Spanish, Russian, Italian, and Portuguese are available only for the menu text.

To set the oscilloscope's language:

Step 1. Press the  key to enter the **SETTINGS** menu.

Step 2. Press the  softkey to toggle the beeper state.

Step 3. Use the **Universal Knob** to select the desired language.

13.6 Update Firmware and Configuration

The firmware and configuration can be updated directly via a USB flash drive.

13.6.1 Update Firmware

To update the firmware:

Step 1. Press the  key to enter the **SETTINGS** menu.

Step 2. Press the  softkey twice to navigate to page **3/3** of the **SETTINGS** menu.

Step 3. Press the  softkey to enter the **Update** submenu.

Step 4. Press the  softkey to enter the firmware directory selection folder.

Step 5. Use the **Universal Knob** to select the desired firmware file.

Step 6. Press the  softkey to start updating the firmware.

- The update process can take up to 4 minutes.







Do not remove the USB drive while the instrument is updating. Removing the USB drive during the update may permanently damage the instrument.

Step 7. When the update is complete the prompt "**Firmware decompressed. Please restart and wait...**" will be displayed.

Step 8. Restart the oscilloscope to finish the firmware update procedure.

13.6.2 Update Configure

To update the Configuration:

- Step 1.** Press the  key to enter the **SETTINGS** menu.
- Step 2.** Press the  softkey twice to navigate to page **3/3** of the **SETTINGS** menu.
- Step 3.** Press the  softkey to enter the **Update** submenu.
- Step 4.** Press the  softkey to enter the configure directory selection folder.
- Step 5.** Use the **Universal Knob** to select the desired configuration file.
- Step 6.** Press the  softkey to start updating the configuration.
 - The update process can take up to 40 seconds.



Do not remove the USB drive while the instrument is updating. Removing the USB drive during the update may permanently damage the instrument.

- Step 7.** When the update is complete the prompt "**Firmware decompressed. Please restart and wait...**" will be displayed.
- Step 8.** Restart the oscilloscope to finish the firmware update procedure.

13.7 Self Test

Self-tests include screen test, keyboard test, and LED test. Self-tests used to test the screen, buttons, knobs and LED lights whether works well.

13.7.1 Screen Test

To run the self test:

Step 1. Press the  key to enter the **SETTINGS** menu.

Step 2. Press the  softkey twice to navigate to page **3/3** of the **SETTINGS** menu.

Step 3. Press the  softkey to enter the **Do Self Test** submenu.



Step 4. Press the  softkey to enter the **Screens Test** interface.



Figure 13.3 Screen Test

Step 5. Press the  softkey continually as indicated.

- The screen displays green, blue and red again. Check chromatic aberration, stain and scratch of the screen in each color.

Step 6. Press the  key to exit the screen test program.

13.7.2 Keyboard Test

To run the keyboard test:

- Step 1.** Press the **Utility** key to enter the **SETTINGS** menu.
- Step 2.** Press the **F5** softkey twice to navigate to page **3/3** of the **SETTINGS** menu.
- Step 3.** Press the **F2** softkey to enter the **Do Self Test** submenu.
- Step 4.** Press the **F2** softkey to enter the **Keyboard Test** interface.

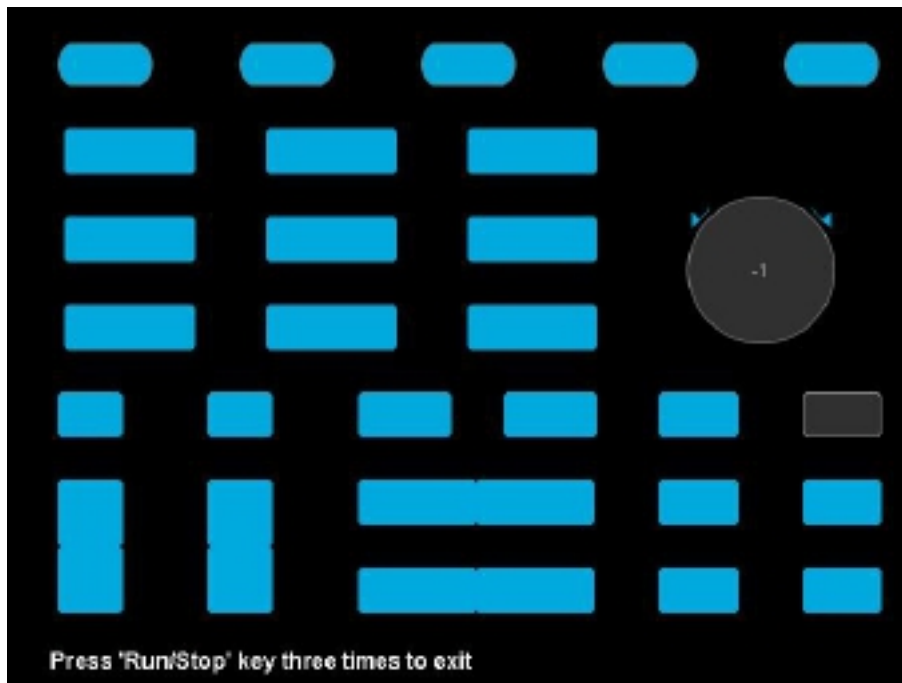

Figure 13.4 Screen Test

- Step 5.** Perform the knobs and the buttons test.
 - **Knobs test:** The default value is 0. Turn left to increase the value, and turn right to decrease; push the knob to set the color to turquoise blue.
 - **Keys test:** The first time pressing the key to light it up, and a second pressing to die out. Test every button randomly.
- Step 6.** Press the **Run/Stop** key 3 times to exit the screen test program.

13.7.3 LED Test

To run the LED test:

- Step 1.** Press the **Utility** key to enter the **SETTINGS** menu.
- Step 2.** Press the **F5** softkey twice to navigate to page **3/3** of the **SETTINGS** menu.
- Step 3.** Press the **F2** softkey to enter the **Do Self Test** submenu.
- Step 4.** Press the **F2** softkey to enter the **LED Test** interface.

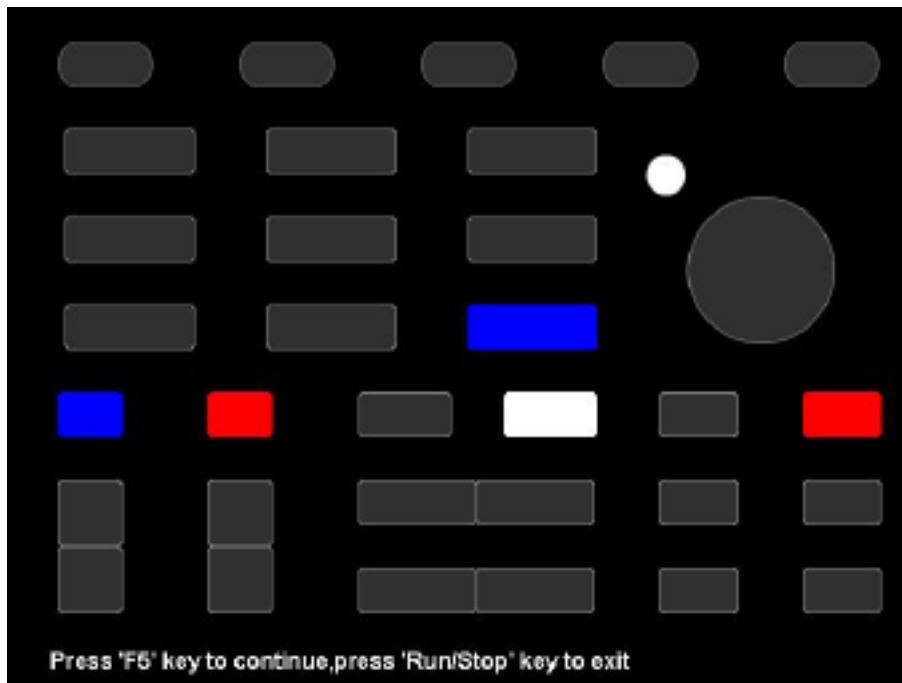

Figure 13.5 Screen Test

- Step 5.** Press the **F5** softkey continually as indicated.
 - The LED will light up one by one.
 - Once you have cycled through the LEDs once the next **F5** softkey press will simultaneously enable all LEDs.
 - The next **F5** softkey press will repeat the cycle.
- Step 6.** Press the **Run/Stop** key to exit the screen test program.

13.8 Screen Saver

The screen will be blanked once the oscilloscope enters the idle state and holds for the specified period of time.

To set the screen saver state and time:

- Step 1.** Press the **Utility** key to enter the **SETTINGS** menu.
- Step 2.** Press the **F5** softkey twice to navigate to page **3/3** of the **SETTINGS** menu.
- Step 3.** Press the **F2** softkey to select **Screen Saver**.
- Step 4.** Use the **Universal Knob** to select the idle time that will trigger screen saver mode.

NOTICE

Press any button on the front panel to exit the screen saver mode.

13.9 Date and Time

To enable/disable the date and time display:

- Step 1.** Press the **Utility** key to enter the **SETTINGS** menu.
- Step 2.** Press the **F5** softkey to navigate to page **2/3** of the **SETTINGS** menu.
- Step 3.** Press the **F3** softkey to enter the **Date/Time** submenu.
- Step 4.** Press the **F4** softkey to toggle the date and time display state.

13.9.1 Set Date

To set the date:

- Step 1.** Press the **Utility** key to enter the **SETTINGS** menu.
- Step 2.** Press the **F5** softkey to navigate to page **2/3** of the **SETTINGS** menu.
- Step 3.** Press the **F3** softkey to enter the **Date/Time** submenu.
- Step 4.** Press the **F1** softkey to enable configuration of the date.

Step 5. Use the **Universal Knob** to set the date.

Step 6. Press the **F5** softkey to confirm the new date.

13.9.2 Set Time

To set the time:

Step 1. Press the **Utility** key to enter the **SETTINGS** menu.

Step 2. Press the **F5** softkey to navigate to page **2/3** of the **SETTINGS** menu.

Step 3. Press the **F3** softkey to enter the **Date/Time** submenu.

Step 4. Press the **F2** softkey to enable configuration of the time.

Step 5. Use the **Universal Knob** to set the time.

Step 6. Press the **F5** softkey to confirm the new time.

13.9.3 Set Zone

To set the time zone:

Step 1. Press the **Utility** key to enter the **SETTINGS** menu.

Step 2. Press the **F5** softkey to navigate to page **2/3** of the **SETTINGS** menu.

Step 3. Press the **F3** softkey to enter the **Date/Time** submenu.

Step 4. Press the **F2** softkey to enable configuration of the time zone.

Step 5. Use the **Universal Knob** to select the time zone.

Step 6. Press the **F4** softkey to confirm the new time zone.

Step 7. Press the **F5** softkey to confirm the new settings and exit the **Date/Time** sub menu.

13.10 Reference Position

The reference position setting determines the physical point that the oscilloscope uses during vertical and horizontal scale changes. In some situations, a fixed position is more convenient.

To set the reference position:

- Step 1.** Press the **Utility** key to enter the **SETTINGS** menu.
- Step 2.** Press the **F5** softkey to navigate to page **3/3** of the **SETTINGS** menu.
- Step 3.** Press the **F3** softkey to enter the **Reference Position** submenu.
- Step 4.** Press the **F1** softkey to toggle the vertical position between **Fixed Position** and **Offset Position**.
- Step 5.** Press the **F2** softkey to toggle the horizontal position between **Fixed Position** and **Fixed Delay**.

Fixed Point

The designated point on the screen where the waveform is displayed. This point serves as the baseline reference for all subsequent measurements and allows the user to accurately measure the amplitude, frequency, and other characteristics of the waveform.

The reference position is located at the center of the screen, but it can be adjusted. It is important to have a fixed reference position to ensure consistency in measurements and to make it easier to compare different waveforms.

Once the reference position is set, the oscilloscope will display the waveform relative to that position, making it easier for the user to make accurate measurements and analyze the signal.

Fixed Delay

Synchronizes the display of signals on the screen with a specific point in time. This is achieved by introducing a constant delay between the trigger event that starts the acquisition and the display of the waveform on the screen.

This feature can be useful for a variety of applications, such as analyzing periodic signals or capturing transient events. By adjusting the delay, users can position the waveform on the screen to align with a specific point of interest, making it easier to analyze and measure various characteristics of the signal.

Fixed delays are different from variable time base delays, which allow users to adjust the delay time continuously. With fixed delays, the delay time remains constant and can be set by the user based on their specific requirements.

Search

The search function allows the user to quickly locate and capture specific waveform events that occurred in the past. With this feature, the user can search for waveforms that meet specific criteria, such as a particular frequency, amplitude, or time interval.

The search function involves setting up a search condition and then scanning through the captured waveform data to find occurrences that match the criteria. The matching results are displayed with black triangle symbol.

In the YT mode or the Roll mode with the acquisition in stop, the maximum search events number is 600. In the Roll mode with acquisition in run, the maximum search events number is unlimited. The waveform can be zoomed when search function is enabled.

This feature is particularly useful in troubleshooting and debugging electronic circuits, as it enables you to identify and analyze specific waveform events that might otherwise be difficult to detect. Additionally, it can save you time and effort by allowing you to quickly locate the specific event you are interested in, rather than having to manually scan through the waveform data.

14.1 Settings

Setting up searches is similar to setting up triggers. In fact, except for Frequency Peaks and Serial events, you can copy search setups to trigger setups and vice-versa.

Searches are different than triggers in that they use the measurement threshold settings instead of trigger levels.

Found search events are marked with black triangles at the top of the graticule, and the number of events found is displayed in the menu line just above the softkey labels displayed as "**Event Num:**".

To configure the search settings:

Step 1. Press the  and the  key to enter the **SEARCH** menu.

Step 2. Press the  softkey to toggle between view the dropdown menu containing the search types.

Step 3. Use the **Universal Knob** to select the desired search type.

- For setting up Edge searches, see **Edge Trigger** in [section](#) .
- For setting up Slope searches, see **Slope Trigger** in [section](#) .
- For setting up Pulse searches, see **Pulse Trigger** in [section](#) .
- For setting up Interval searches, see **Interval Trigger** in [section](#) .
- For setting up Runt searches, see **Runt Trigger** in [section](#) .

Step 4. Press the  softkey to enter the "**Copy Setting**" menu.

- From the **Copy Setting** menu the current set search settings can be copied to the trigger settings and vice versa.

Step 5. In the **SEARCH** menu press the  softkey to enter the **THRESHOLDS** menu.

- In the **THRESHOLDS** menu the channel and the channel's threshold can be configured.

Navigate

The 2510b series provides three navigation types: Search Event, Time, and History Frame.

15.1	Navigating the Time Base	160
15.2	History Frame Navigate	161
15.3	Search Event Navigate	161

15.1 Navigating the Time Base

To navigate the time base:

Step 1. Press the  and the  key to enter the **NAVIGATE** menu.

Step 2. Press the  softkey to view the **Type** drop-down menu.

- Use the **Universal Knob** to select **Time**.

Step 3. There are two ways to navigate time:

- a. Press the  softkey and turn the **Universal Knob** to select the desired value, or press the **Universal Knob**, then enter the value using the virtual keypad.
- b. Use the corresponding softkeys to reverse, stop, or play the waveform.

NOTICE

Pressing the reverse and play softkey multiple times speeds up the playback. There are three speed levels: low, medium, and high.

15.2 History Frame Navigate

The navigation controls can be used to play through the frames acquired while the **History** function was enabled.

To navigate through the history frames:

Step 1. Press the  and the  key to enter the **NAVIGATE** menu.

Step 2. Press the  softkey to view the **Type** drop-down menu.

- Use the **Universal Knob** to select **History Frame**.

Step 3. There are two ways to navigate time:

- a. Press the  softkey and turn the **Universal Knob** to select the desired frame number, or press the **Universal Knob**, then enter the value using the virtual keypad.
- b. Use the corresponding softkeys to reverse, stop, or play the waveform.

15.3 Search Event Navigate

When the Search function is enabled and acquisitions are stopped, the navigation controls can be used to view the found search events.

To view the search events:

Step 1. Press the  and the  key to enter the **NAVIGATE** menu.

Step 2. Press the  softkey to view the **Type** drop-down menu.

- Use the **Universal Knob** to select **Search Event**.

Step 3. There are two ways to navigate time:

- a. Press the  softkey and turn the **Universal Knob** to select the desired value, or press the **Universal Knob**, then enter the value using the virtual keypad.
- b. Use the corresponding softkeys to reverse, stop, or play the waveform.

History

The history function of an oscilloscope is a feature that allows the user to capture and display a waveform over a longer time period than what is visible on the screen. In traditional oscilloscopes, the display shows only the most recent waveform, which makes it difficult to observe changes or patterns that occur over a longer period.



With the history function, the oscilloscope continuously captures the waveform data and stores it in a memory buffer. The user can then scroll back through the captured data to view the waveform over a longer period. This feature is especially useful for troubleshooting intermittent or sporadic signals, as it allows the user to go back in time to capture the exact moment when an anomaly occurred.

In run state, the oscilloscope records input waveform continually; when fill up the memory (reach the maximal frame), the new frames will cover the old frames and keep the latest frames.

To use the **History** function, the **Horizontal Format XY** must be disabled.

To record and replay a waveform:

Step 1. Press the  and the  key to enter the **HISTORY** menu.

- If the scope's acquisition state is set to run when entering the **HISTORY** menu, the waveform acquisition will be stopped.
- If the scope's acquisition state is set to stop when entering the **HISTORY** menu, the oscilloscope will maintain the stop state.
- Press the  and the  key again to turn off the **HISTORY** function.

Step 2. In the **HISTORY** menu press the  to navigate to **page 2/2**.

Step 3. In **page 2/2** of the **HISTORY** menu press the  softkey to toggle the **List** function.

- The **List** function records the timestamp of every frame with an accuracy of microseconds.

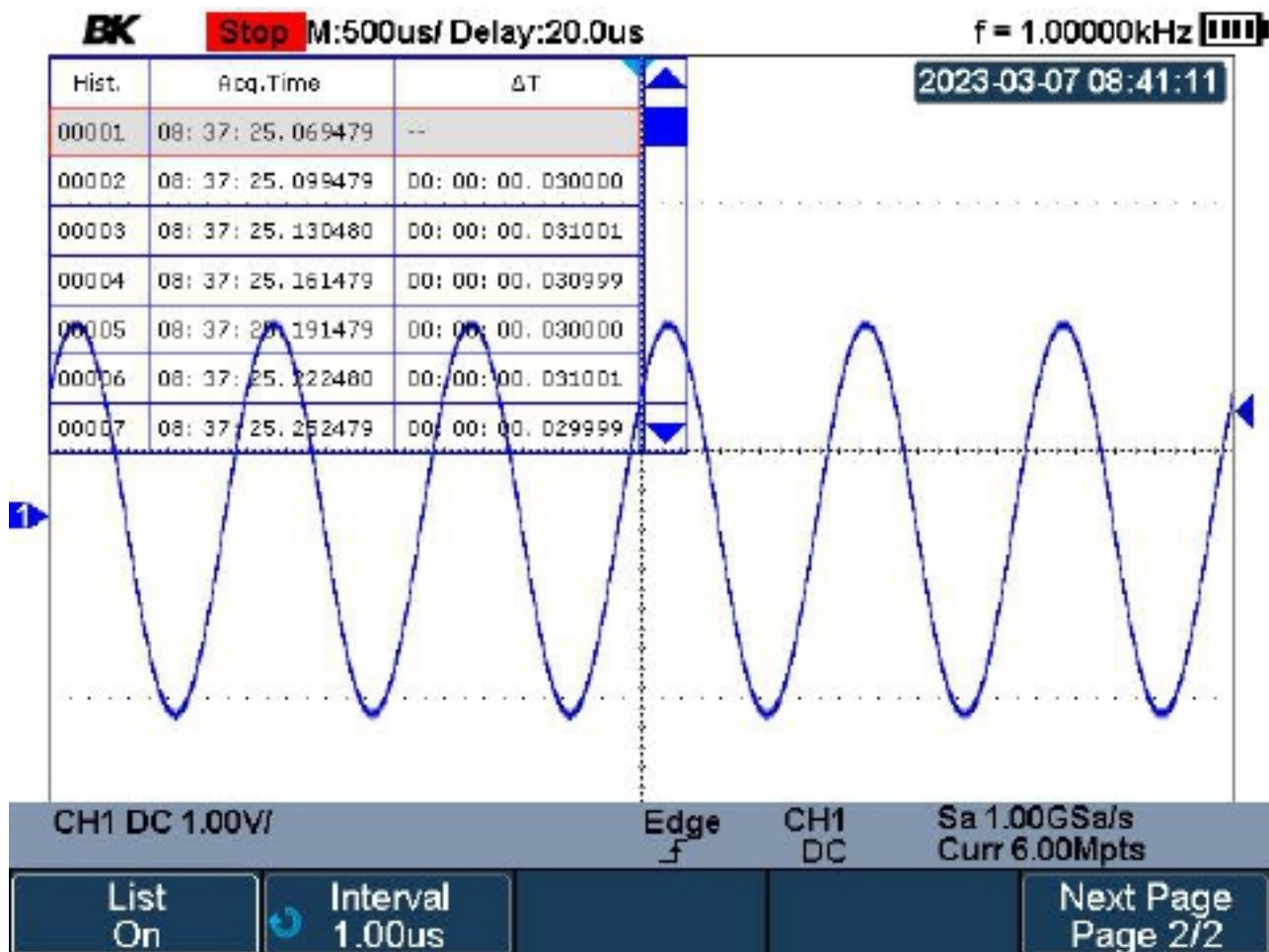

Figure 16.1 History List

Step 4. In **page 1/2** of the **HISTORY** menu press the **F1** softkey to select the fram to be displayed.

- The Frame format is A/B; wehre A is the frames number that is displayed on the screen and B is the maximum frame number you can set.
- The maximum frame number is determined by the current sampling point (Curr value) and sampling rate.
- Pressing the **Run/Stop** button or enablig the history function, may not get the maximum frames if memory is not filled. To fill the maximum frames, please wait for enough time for the acquisition to complete.

Meter



This chapter provides a step by step introduction to the multimeter functions of the 2510B Handheld Digital Oscilloscope. The introduction gives basic examples to show how to use the menus and perform basic operations.

The digital multimeter provides the following measurements: DC voltage, AC voltage, resistance, diode, continuity, capacitance, DC current, and AC current.

All metering types provide the relative value function. When Relative value is enabled the current input value is saved as a reference. All measurements taken after enabling relative value are the difference between the actual signal and the relative value.

NOTICE

2511B, 2512B: CAT III 300 Vrms, CAT II 600 Vrms
2515B, 2516B: CAT III 600 Vrms, CAT II 1000 Vrms

To access the **Meter** function press the   key.

17.1	Meter Front Panel	165
17.2	DCV/ACV	166
17.3	Resistance	167
17.4	Diode	168
17.5	Continuity	169
17.6	Capacitance	170
17.7	DCI/ACI	171

17.1 Meter Front Panel

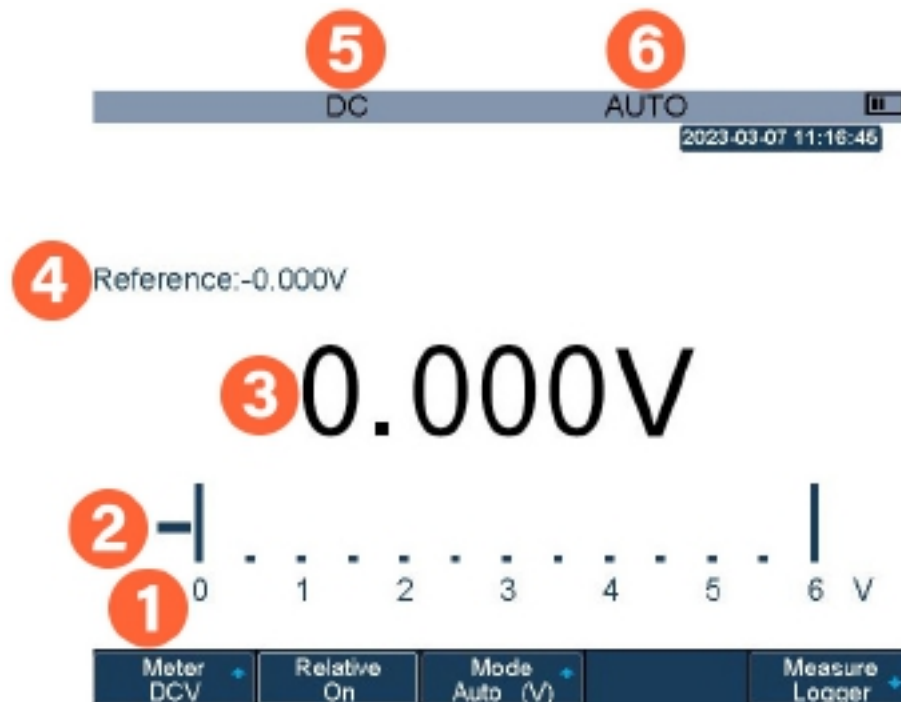



Figure 17.1 Meter Display

Item	Name	Description
1	Multimeter Range	Visual presentation of the the set range.
2	Bar Graph	Displays live measurements on a horizontal bar graph.
3	Measurement	Visual presentation of the measurement.
4	Reference Value	Displays the set reference value.
5	Measurement Type	Displays the selected measurement type.
6	Measurement Mode	Displays the selected range mode.

Table 17.1 Front Panel

17.2 DCV/ACV

To enable DCV or ACV metering and set the range:

Step 1. Press the  key.

Step 2. Press the  softkey to view the available metering option.

- Use the **Universal Knob** to select "DCV or "ACV".

Step 3. Press the  softkey to view the available mode options.

- Use the **Universal Knob** to one of the available modes.
- If manual was selected press the  softkey to toggle between the available ranges.

When DCV or ACV is applied the following ranges are available:

DCV/ACV Metering			
Function	Range	Resolution	Accuracy
DC Voltage	60.00 mV	10 μ V	($\pm 1\%$ ± 15 digit)
	600.00 mV	100 μ V	($\pm 1\%$ ± 5 digit)
	6.00 V	1 mV	
	60.00 V	10 mV	
	600.00 V	100 mV	
	1000.00 V	1 V	($\pm 1.5\%$ ± 15 digit)
AC Voltage 45 hz to 400Hz	60.00 mV	10 μ V	($\pm 1\%$ ± 15 digit)
	600.00 mV	100 μ V	($\pm 1\%$ ± 5 digit)
	6.00 V	1 mV	
	60.00 V	10 mV	
	600.00 V	100 mV	
	750.00 V	1 V	($\pm 1.5\%$ ± 15 digit)

Table 17.2 DCV & ACV Ranges

17.3 Resistance

To enable the Resistance Metering:

Step 1. Press the  key.

Step 2. Press the  softkey to view the available metering option.

- Use the **Universal Knob** to select "RES."

Step 3. Press the  softkey to toggle between "Auto" and "Manual" mode.

- If manual was selected press the  softkey to view the available ranges.
- Use the **Universal Knob** to select the desired range.

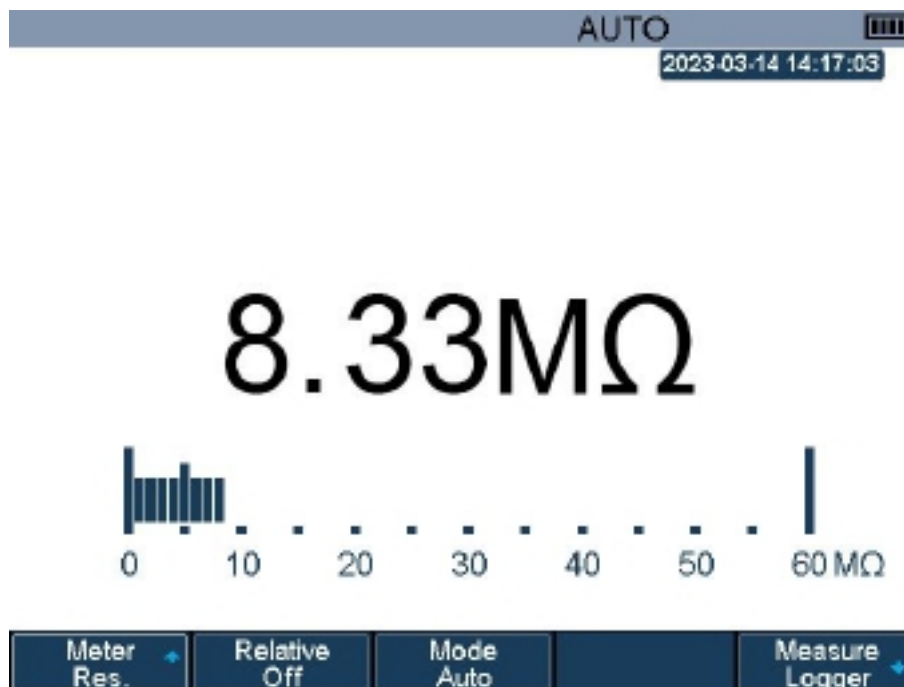

Figure 17.2 Resistance Measurement

NOTICE

Before measuring resistant, verify the circuit is power off and the capacitance is discharged to avoid damaging the 251XB.

17.4 Diode

The **Meter** function can also be used to test the function of a diode. To test a diode using the meter function, the diode is connected to the meter input positive to anode, negative to cathode for forward-biased diodes, and positive to cathode, negative to anode for reverse-bias diodes. The meter will then measure the voltage drop across the diode.

In forward bias mode, a value falling between 0.6 to 0.7 indicates a healthy and ideal state of the diode if it's a silicon diode. The value will show in between the range of 0.25 to 0.3, in the case of germanium diodes, while in reverse bias mode, there should be no or very little current flowing through the diode. The diode test is useful for verifying the polarity and health of diodes in electronic circuits.

Reversing the condition of the diode by connecting the will prevent current flow through the device. The meter will indicate the **Overload** in the case of a healthy diode indicating an open circuit. The meter showing irrelevant values indicates that the diode is defective, maybe open or short. No current flows through an open diode. It's pretty much like an open switch that allows zero current to flow through the diode.

When the voltage drop across the diode is zero, it will indicate the flow of current and is called a shorted diode. In such a case, zero voltage value is indicated on the meter.

Step 1. Press the  key.

Step 2. Press the  softkey to view the available metering option.

- Use the **Universal Knob** to select "Diode."



Figure 17.3 Diode Measurement

17.5 Continuity

The **Continuity** test is a quick and easy way to determine if there is a complete electrical path between two points in a circuit. When performing a continuity test, a small current is sent through the circuit and the resistance between the two points is measured. If the resistance is low enough, around 50 ohms or less, the scope will emit a beep to indicate that there is a continuous path for the current to flow.

This test is useful for verifying the integrity of electrical connections, checking for shorts or open circuits, and troubleshooting problems in electronic devices.

To run a continuity test:

Step 1. Press the  key.

Step 2. Press the  softkey to view the available metering option.

- Use the **Universal Knob** to select "**Continuity**."

Step 3. Insert the red probe to the V.Ω.C banana jack input and the black probe to the

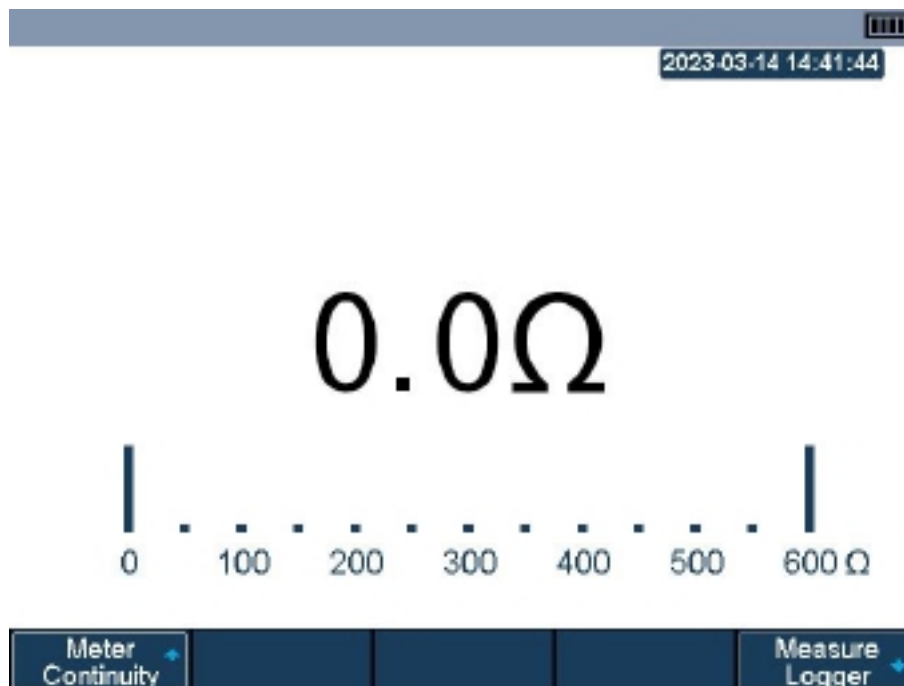

Figure 17.4 Diode Measurement

NOTICE

When the measured object is under 50Ω, the multimeter will alarm and read value. When the measured object is above 50Ω, the multimeter will not alarm but read value.

17.6 Capacitance

The capacitance of a capacitor can be measured using the **Capacitance** function of the meter. The meter applies a small voltage to the capacitor and measure the time it takes for the capacitor to charge up to the applied voltage. From this measurement, the meter calculates the capacitance of the capacitor. The capacitance measurement is useful for verifying the values of capacitors in electronic circuits and testing the health of capacitors.

To measure capacitance:

Step 1. Press the  key.

Step 2. Press the  softkey to view the available metering option.

- Use the **Universal Knob** to select "Cap."

Step 3. Disconnect the capacitor from the circuit and discharge it.

Step 4. Connect the capacitor to the meter input.

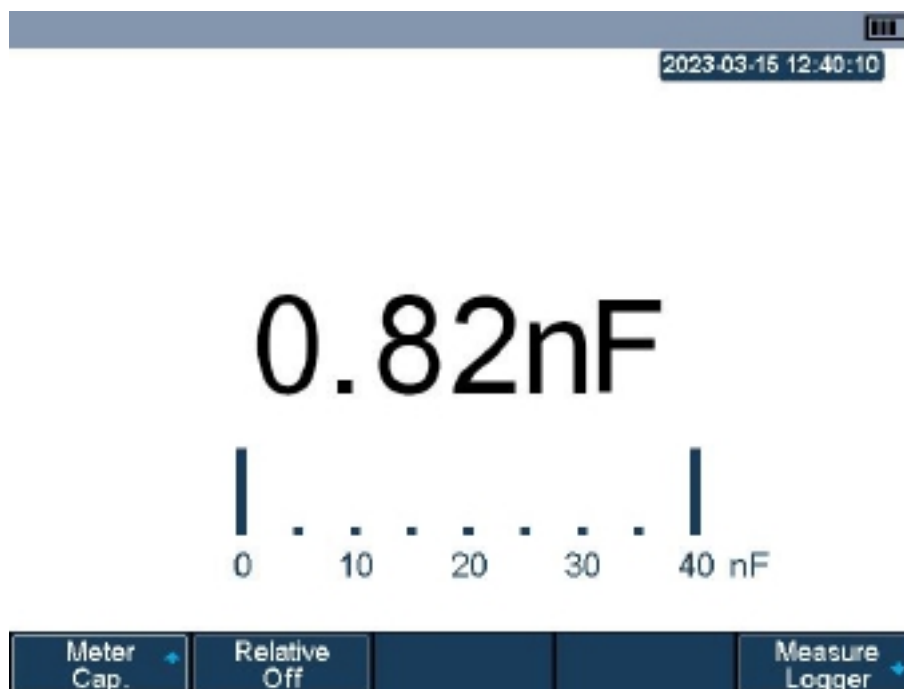

Figure 17.5 Capacitance Measurement

17.7 DCI/ACI

DCI/ACI (Direct Current Amperes/Alternating Current Amperes) measures the flow of direct current/alternating current in amperes. It is commonly used to measure the current flowing through electrical circuits, components, or devices that operate on DC/AC power.

The DCI/ACI meter functions allows the 2510B series to measure up to 10 A by using the accessory **FS10A** or **FS06A**.



FS06A

FS10A

To measure DCI or ACI:

Step 1. Press the  key.

Step 2. Press the  softkey to view the available metering option.

- Use the **Universal Knob** to select "**ACI**" or "**DCI**".

Step 3. Connect the **FS10A** or **FS06A** adapter to the meter input terminals.

Step 4. Insert the red probe to the "+" banana jack input and the black probe to the "-" banana jack input.

- Connect the other end of probes to the power or load to be measured in series.

Step 5. Enable/Disable the relative measurement state by pressing the  softkey.

Step 6. Press the  softkey to view the available mode options.

- Use the **Universal Knob** to one of the available modes.
- If manual was selected press the  softkey to toggle between the available ranges.

NOTICE

To perform these measurement connect the meter in series with the circuit or device being measured, allowing the meter to measure the amount of current flowing through it.

Smample Logger

The **Sample Logger** can record the original waveform points in real time at equal intervals to capture a long-time observation of low-speed signals. The recorded data can be stored in the internal memory or in an external storage device.

Once recording is stoppoed, the waveform data can be recalled from internal memory or an external storage device to be viewed jin the oscilloscope. The data can also be exported to be analyzed on a PC.

18.1	Sample Logger Interface	173
18.2	Record	174
18.2.1	Record Settings	174
18.2.2	Recall Recorded Waveform	175
18.2.3	Display Control	175

18.1 Sample Logger Interface

To access the **Sample Logger** function  key, then press the **F1** softkey to enter the **Sample Logger** interface. While in the **Sample Logger** interface all buttons, except for the softkeys, **Universal Knob**, and the Operation Mode keys, will be locked.



Figure 18.1 Sample Logger Interface

Item	Name	Description
1	Record Status	Displays the recording status.
2	Horizontal Scale	Displays the time/div (sweep speed) setting.
3	Recorded Time	Displays the elapsed time of the logger.
4	Remaining Recordable Time	Displays the remaining recordable time before the memory is filled.
5	Recorded Waveform	Displays the waveform acquisition.
6	Storage Location	Displays the save location of the logger file.
7	Start Time	Displays the date and time the logging began.
8	Sample Rate	Displays the sample rate and the recorded points of the waveform.

Table 18.1 Sample Logger Interface

18.2 Record

To record a waveform:

Step 1. Press the  key to enter **Recorder** mode.

Step 2. In recorder mode press the  softkey to select **Sample Logger**.

Step 3. In the **Sample Logger Interface** press the  softkey to select **Record**.

- The **Record** menu contains three options **Settings**, **Start**, and **Recall**.

Step 4. In the **Record** menu press the  softkey to select **Settings**.

- Configure the recording's settings. (See [subsection 18.2.1](#) for more details)
- Press the  to exit the **Settings** menu and return to **Record**.

Step 5. Press  softkey while in the **Record** menu to begin logging.

Step 6. Upon completing logging, press the  softkey to recall the data.

Step 7. Press the **Press to Recall** softkey to recall the recorded waveform data and enter the **CONTROL** menu automatically.



NOTICE

When recording to an external device, the waveform data will be stored in real time. Removing the device during the recording may cause the data to be corrupted/lost.

18.2.1 Record Settings

In **Settings** the sampling rate, file location and file name can be configured.

To configure the **Sampling Rate** press the  while in **Sample Logger** settings menu. A pop-up menu containing all available sampling rates will appear. Use the **Universal Knob** to navigate through the menu and select the desired rate.

To toggle between **Internal** and **External** file location press the  button while in the **Sample Logger** settings menu. When **External** is selected the **File Name** softkey label will be available for . Press the  to assign the file location and name in the external storage device.

Upon configuring the record settings, press the  button to return to the **Record** menu. In the **Record** menu press the  button to **Start** recording.

18.2.2 Recall Recorded Waveform

To recall the recently recorded waveform, press the **F3** softkey while in the **Record** menu. This softkey will be disabled if no waveforms have been recorded since entering the **Record** menu. After recording a waveform the **Recall** softkey in the **Record** menu, **F3**, will be enabled.

To recall waveforms previously saved, press the **F3** softkey while in the **Sample Logger** menu. Once in the **Recall** pressing the **F1** softkey to select the memory from where the waveform will be recalled (Internal or External memory).

NOTICE

When **Recall from External** is selected press the **F3** softkey to select the desired waveform file.

Press the **F4** softkey to recall the waveform and enter the **Display Control** menu.

18.2.3 Display Control

Step 1. Press the **F2** softkey to set the horizontal reference position.

Step 2. Press the **0** **0.5** button to zoom the waveform with the horizontal reference as the center.

– Press the **←** **→** button to move the waveform.

Step 3. Press the **F1** softkey to return to the initial configuration to **View all** waveforms.

Step 4. After recalling the waveform, press the **Save/Recall** **Cursors** button enable the cursors function. The cursors can be used to measure and analyze the waveform. For more information about cursors refer to [Chapter 9](#).

Measure Logger

19.1	Measure Logger Settings	178
19.1.1	Log Interval	178
19.1.2	Select Trace and Measure Item	178
19.2	Start/Stop Recording	178
19.3	Display Control	179
19.3.1	Vertical Scale	179
19.3.2	Horizontal	179
19.3.3	Display	180
19.3.4	Cursors	180
19.4	Save/Recall	182

The measure logger allows users to capture and record measurements taken by the oscilloscope over a period of time, providing a comprehensive view of waveform behavior and signal characteristics of low-speed signals.

By leveraging the oscilloscope measure logger function, the can gain valuable insights into the behavior and performance of waveforms over extended periods, making it an essential tool for a wide range of applications, including electronics design, signal analysis, and troubleshooting.

The measured data can be stored in internal or external memory and supports up to 4 measurements at a time.

To enable the **Measure Logger**:

Step 1. Press the  button to enter the **Recorder** menu.

Step 2. In the **Recorder** menu, press the  softkey to enter and enable the **Measured Logger** function menu shown in [figure 19.1](#).



Figure 19.1 Measure Logger Menu

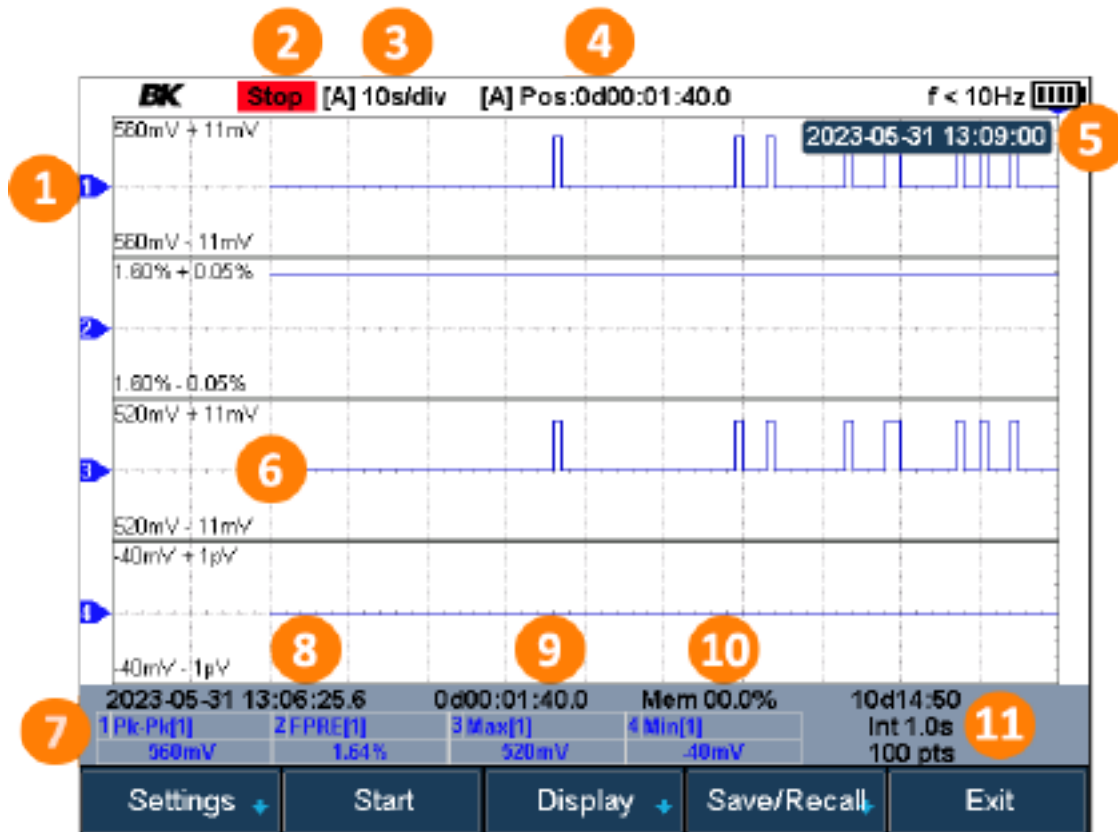

Figure 19.2 Measure Logger Interface

Item	Name	Description
1	Record Trace	Displays the trace being recorded.
2	Record Status	Displays the recording status.
3	Horizontal Scale	Displays the time/div (sweep speed) setting.
4	Recorded Time	Displays the elapsed time of the logger.
5	Reference Position	Displays the horizontal reference position.
6	Scale Range	Displays the upper and lower scale of the trace.
7	Measurement	Displays the current value of the measured item.
8	Start Time	Displays the date and time the logging began.
9	Used Memory	Displays the percentage of the used memory.
10	Recorded Time	Displays the elapsed time of the logger.
11	Record Info	Displays the remaining recordable time, recording interval, and number of recorded points.

Table 19.1 Measure Logger Interface

19.1 Measure Logger Settings

To enter the **Measure Logger Settings** menu (shown in **figure 19.3**) press the **F1** softkey while in the **Measure Logger** menu.



Figure 19.3 Measure Logger Settings

19.1.1 Log Interval

Press the **F1** softkey to configure the sampling interval. The interval can be configured between 100 ms to 10 minutes.

NOTICE

The Log Interval affect the remaining recordable time. The faster the interval the less recordable time available.

19.1.2 Select Trace and Measure Item

Press the **F2** softkey to select the trace to be configured. Once a trace has been selected press the **F3** softkey to assign one of the selected measurements to the selected trace.

19.2 Start/Stop Recording

To start the logger press the **F2** softkey while in the **Measure Logger menu**. Once logging begins the **F2** softkey function will change to **Stop** and the **Record Status** will display Run.

Press the **F2** softkey to stop the logger acquisition. Once logging stops the **F2** softkeyfunction will return to **Start** and the **Record Status** will display **Stop**.

19.3 Display Control

To enter the **Measure Logger Display** menu (shown in [figure 19.4](#)) press the **F3** softkey while in the **Measure Logger** menu.



Figure 19.4 Measure Logger Display

19.3.1 Vertical Scale

Press the **F1** softkey to adjust the vertical scale. Once **Vertical Scale** is selected use the **Universal Knob** to increase/decrease the vertical scale of all active traces.

The vertical scale can also be configured using the vertical scale buttons on the front panel.

19.3.2 Horizontal

Press the **F2** softkey to enter the **Horizontal Control** menu shown in [figure 19.5](#)



Figure 19.5 Measure Logger Horizontal Control

In the **Horizontal Control** menu users can manipulate the logger trace in order to customize the display according to their needs, or utilize the **Auto Set** function to restore the default state whenever desired.

To zoom and move the logger trace and set the horizontal reference position, follow these steps:

- Step 1.** Press the **F1** softkey or use the horizontal scale button to adjust the scale of the logger trace.
 - This control allow users to zoom in and out of all enabled traces.
- Step 2.** Press the **F2** softkey or use the horizontal position button to adjust the position of all trace.
 - This control allow users to move the enabled traces horizontally across the screen.
- Step 3.** Press the **F3** softkey to adjust the horizontal reference position. This control allows users to set a specific horizontal reference point on the trace to either **Center** or **Right**.

NOTICE

Auto Set (**F4** softkey) is designed to restore the logger trace to its default state. By pressing it, users can revert any changes made to the zoom level, position, or reference point and return to the initial settings

19.3.3 Display

Press the **F3** softkey to select the trace to be displayed. Individual traces can be selected in order to optimize the display for the specified trace, or **All** can be selected to display all enabled traces at once.

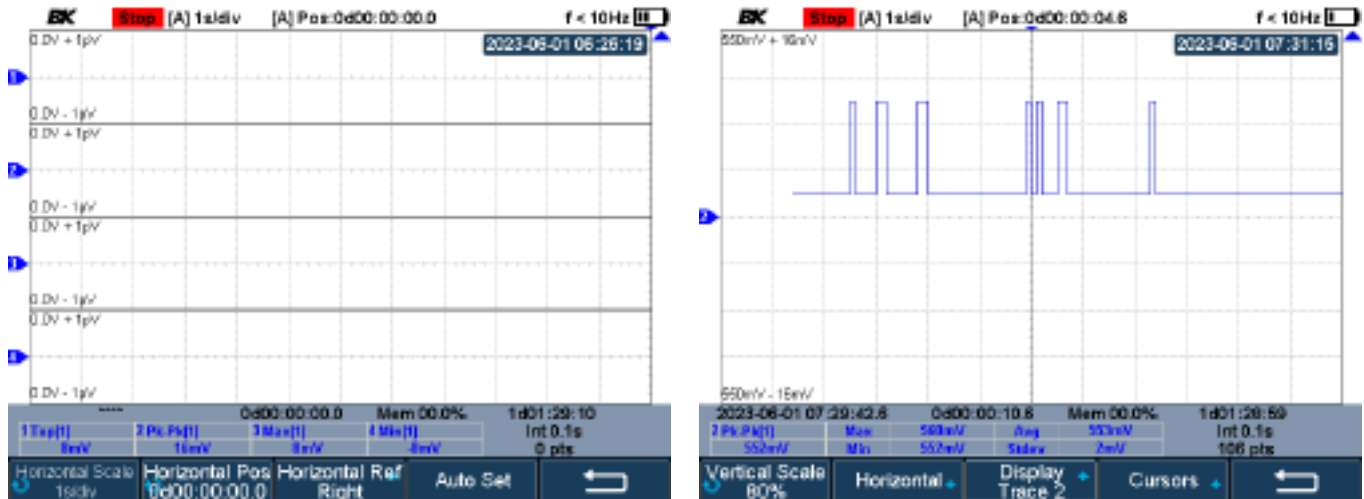

All Traces

Single Trace

Figure 19.6 All vs Single Trace Display

19.3.4 Cursors

Press the **F4** softkey to enter the **Cursors** menu shown in figure 19.7.



Figure 19.7 Measure Logger Cursors Menu

In the **Cursors** menu users can enable/disable the cursor status, select an individual cursor or both cursors to manipulate their position and the track mode.

To configure the cursors, follow these steps:

Step 1. Press the **F1** softkey to toggle the status of the cursors (ON/OFF).

Step 2. Press the **F2** softkey to select the cursor/s to be configured.

Step 3. Press the **F3** softkey to set the **Track Mode** of the cursors.

- **Fixed Position:** Cursors remain fixed to the grid position.
- **Fixed Time:** The time value of the cursors remain fixed.

Step 4. Press the **F4** softkey to configure the **Track Mode** of the cursors.

- **Normal:** Tracks the data at the time of T-Cursors.
- **Maximum:** Tracks the maximum value of the data within a pixel of where the T-Cursors are located.
- **Average:** Tracks the average value of the data within a pixel of where the T-Cursors are located.
- **Minimum:** Tracks the minimum value fo the data within a pixel of where the T-Cursors are located.
- **Peak:** Tracks the data with the maximum deviation from the overall average value within a pixel of where the T-Cursors are located. When two cursors are at the same position, T1 will track the maximum value and T2 will track the minimum value.

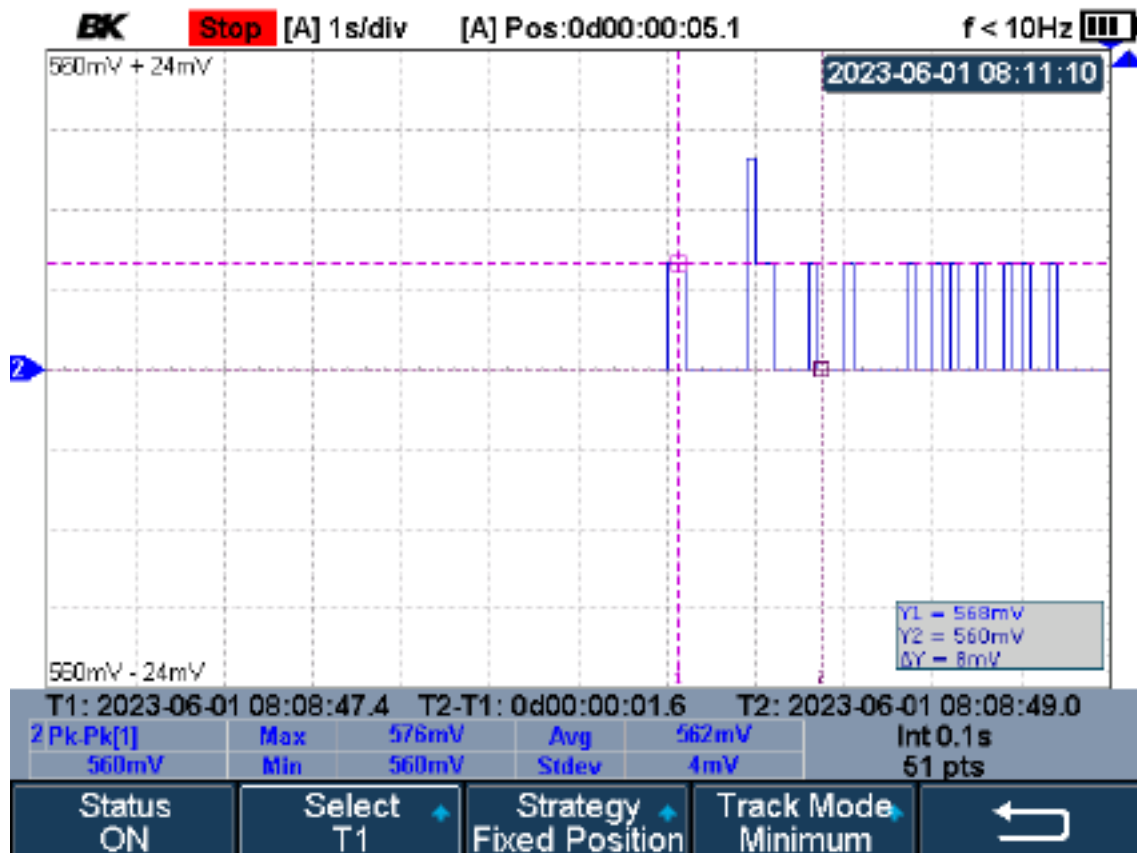

Figure 19.8 Measure Logger Cursors

19.4 Save/Recall

To enter the **Measure Logger Save/Recall** menu (shown in [figure 19.9](#)) press the **F4** softkey while in the **Measure Logger menu**.



Figure 19.9 Measure Logger Save/Recall Menu

In the **Save/Recall** menu users can save/recall files, select the format type to save the file as, and manage all previously saved files.

To save or recall a file, follow these steps:

- Step 1.** Press the **F1** softkey to toggle between **Save** and **Recall** mode.
- Step 2.** Press the **F2** softkey to select the format of the file being saved or loaded (Binary or Matlab data).
- Step 3.** Press the **F4** softkey to enter the **File Manager** menu.
 - In the file manager the user can navigate the directories to view the available files or store the collected data to the specified directory.
 - Files can also be copied, renamed, or deleted in the file manager.

Service Information

Warranty Service: Please go to the support and service section on our website at bkprecision.com to obtain an RMA #. Return the product in the original packaging with proof of purchase to the address below. Clearly state on the RMA the performance problem and return any leads, probes, connectors and accessories that you are using with the device.

Non-Warranty Service: Please go to the support and service section on our website at bkprecision.com to obtain an RMA #. Return the product in the original packaging to the address below. Clearly state on the RMA the performance problem and return any leads, probes, connectors and accessories that you are using with the device. Customers not on an open account must include payment in the form of a money order or credit card. For the most current repair charges please refer to the service and support section on our website.

Return all merchandise to B&K Precision Corp. with prepaid shipping. The flat-rate repair charge for Non-Warranty Service does not include return shipping. Return shipping to locations in North America is included for Warranty Service. For overnight shipments and non-North American shipping fees please contact B&K Precision Corp.

Include with the returned instrument your complete return shipping address, contact name, phone number and description of problem.

B&K Precision Corp.
22820 Savi Ranch Parkway
Yorba Linda, CA 92887
bkprecision.com
714-921-9095

LIMITED THREE-YEAR WARRANTY

B&K Precision Corp. warrants to the original purchaser that its products and the component parts thereof, will be free from defects in workmanship and materials for a period of **three years** from date of purchase. B&K Precision Corp. will, without charge, repair or replace, at its option, defective product or component parts. Returned product must be accompanied by proof of the purchase date in the form of a sales receipt.

To help us better serve you, please complete the warranty registration for your new instrument via our website www.bkprecision.com

Exclusions: This warranty does not apply in the event of misuse or abuse of the product or as a result of unauthorized alterations or repairs. The warranty is void if the serial number is altered, defaced or removed.

B&K Precision Corp. shall not be liable for any consequential damages, including without limitation damages resulting from loss of use. Some states do not allow limitations of incidental or consequential damages. So the above limitation or exclusion may not apply to you.

This warranty gives you specific rights and you may have other rights, which vary from state-to-state.

B&K Precision Corp.
22820 Savi Ranch Parkway
Yorba Linda, CA 92887
www.bkprecision.com
714-921-9095

Version: June 12, 2023