

BK PRECISION

Battery Capacity Analyzer

with record storage

603B



User Manual

Safety Summary

The following safety precautions apply to both operating and maintenance personnel and must be followed during all phases of operation, service, and repair of this instrument.

WARNING

Before applying power to this instrument:

- Read and understand the safety and operational information in this manual.
- Apply all the listed safety precautions.
- Verify that the voltage selector at the line power cord input is set to the correct line voltage. Operating the instrument at an incorrect line voltage will void the warranty.
- Make all connections to the instrument before applying power.
- Do not operate the instrument in ways not specified by this manual or by B&K Precision.

Failure to comply with these precautions or with warnings elsewhere in this manual violates the safety standards of design, manufacture, and intended use of the instrument. B&K Precision assumes no liability for a customer's failure to comply with these requirements.

Category rating

The IEC 61010 standard defines safety category ratings that specify the amount of electrical energy available and the voltage impulses that may occur on electrical conductors associated with these category ratings. The category rating is a Roman numeral of I, II, III, or IV. This rating is also accompanied by a maximum voltage of the circuit to be tested, which defines the voltage impulses expected and required insulation clearances. These categories are:

Category I (CAT I): Measurement instruments whose measurement inputs are not intended to be connected to the mains supply. The voltages in the environment are typically derived from a limited-energy transformer or a battery.

Category II (CAT II): Measurement instruments whose measurement inputs are meant to be connected to the mains supply at a standard wall outlet or similar sources. Example measurement environments are portable tools and household appliances.

Category III (CAT III): Measurement instruments whose measurement inputs are meant to be connected to the mains installation of a building. Examples are measurements inside a building's circuit breaker panel or the wiring of permanently-installed motors.

Category IV (CAT IV): Measurement instruments whose measurement inputs are meant to be connected to the primary power entering a building or other outdoor wiring.

! WARNING

Do not use this instrument in an electrical environment with a higher category rating than what is specified in this manual for this instrument.

! WARNING

You must ensure that each accessory you use with this instrument has a category rating equal to or higher than the instrument's category rating to maintain the instrument's category rating. Failure to do so will lower the category rating of the measuring system.

Do not operate in an explosive or flammable atmosphere**! WARNING**

Do not operate the instrument in the presence of flammable gases or vapors, fumes, or finely-divided particulates.

! WARNING

The instrument is designed to be used in office-type indoor environments. Do not operate the instrument

- In the presence of noxious, corrosive, or flammable fumes, gases, vapors, chemicals, or finely-divided particulates.
- In relative humidity conditions outside the instrument's specifications.
- In environments where there is a danger of any liquid being spilled on the instrument or where any liquid can condense on the instrument.
- In air temperatures exceeding the specified operating temperatures.
- In atmospheric pressures outside the specified altitude limits or where the surrounding gas is not air.
- In environments with restricted cooling air flow, even if the air temperatures are within specifications.
- In direct sunlight.

! CAUTION

This instrument is intended to be used in an indoor pollution degree 2 environment. The operating temperature range is 0 °C to 40 °C and the operating humidity range is $\leq 95\%$ relative humidity with no condensation allowed.

Measurements made by this instrument may be outside specifications if the instrument is used in non-office-type environments. Such environments may include rapid temperature or humidity changes, sunlight, vibration and/or mechanical shocks, acoustic noise, electrical noise, strong electric fields, or strong magnetic fields.

Do not operate instrument if damaged

WARNING

If the instrument is damaged, appears to be damaged, or if any liquid, chemical, or other material gets on or inside the instrument, remove the instrument's power cord, remove the instrument from service, label it as not to be operated, and return the instrument to B&K Precision for repair. Notify B&K Precision of the nature of any contamination of the instrument.

Clean the instrument only as instructed

WARNING

Do not clean the instrument, its switches, or its terminals with contact cleaners, abrasives, lubricants, solvents, acids/bases, or other such chemicals. Clean the instrument only with a clean dry lint-free cloth or as instructed in this manual.

Do not touch live circuits

WARNING

Instrument covers must not be removed by operating personnel. Component replacement and internal adjustments must be made by qualified service-trained maintenance personnel who are aware of the hazards involved when the instrument's covers and shields are removed. Under certain conditions, even with the power cord removed, dangerous voltages may exist when the covers are removed. To avoid injuries, always disconnect the power cord from the instrument, disconnect all other connections (for example, test leads, computer interface cables, etc.), discharge all circuits, and verify there are no hazardous voltages present on any conductors by measurements with a properly-operating voltage-sensing device before touching any internal parts. Verify the voltage-sensing device is working properly before and after making the measurements by testing with known-operating voltage sources and test for both DC and AC voltages. Do not attempt any service or adjustment unless another person capable of rendering first aid and resuscitation is present.

Do not insert any object into an instrument's ventilation openings or other openings.

Servicing

CAUTION

Do not substitute parts that are not approved by B&K Precision or modify this instrument. Return the instrument to B&K Precision for service and repair to ensure that safety and performance features are maintained.

For continued safe use of the instrument

- Do not place heavy objects on the instrument.
- Do not obstruct cooling air flow to the instrument.
- Do not place a hot soldering iron on the instrument.

Table of contents

1	GENERAL OPERATING INSTRUCTIONS	6
1.1	Ready The 603B	6
2	BUTTON DESCRIPTIONS	8
3	QUICK TEST MODE – SOC	9
3.1	Quick Test Mode - Pass/Fail.....	11
3.2	Quick Test Mode - Charger Circuit Test.....	12
4	MAIN MENU	14
4.1	View/Edit Records.....	14
4.2	Record Indicators	15
4.3	Database Record Format	16
4.3.1	System type field.....	17
4.3.2	On-screen keyboard.....	17
4.3.3	Numeric type fields.....	18
4.4	Add New Record.....	18
4.5	Load Test	18
4.6	System.....	19
4.6.1	Setting date	20
4.6.2	Setting time	20
4.6.3	Deleting records.....	20
4.6.3.1	Delete one record.....	20
4.6.3.2	Delete range of records.....	21
4.6.3.3	Delete all records	22
4.6.4	Factory Restore	22
4.6.5	Calibration	23
4.6.6	SOC Profile Settings.....	23
4.6.7	SOC Table Selection.....	24
4.6.8	Back Light.....	25
4.6.9	SOC Weighting.....	25
4.6.10	Firmware Version.....	26
4.6.11	Fan Start	26
4.7	Record Test Mode.....	27
4.8	Record Mode Charger Circuit Test	28
5	FIRMWARE UPDATE PROCEDURES	30
5.1	Firmware Update Instructions.....	30
5.2	Restoring the Calibration Data.....	33
6	CALIBRATION PROCEDURES	34
6.1	Equipment.....	34
6.2	Voltage Calibration.....	35
6.3	Current Calibration.....	36
6.4	Load Calibration.....	37
7	SPECIFICATIONS	38
8	SERVICE	39
9	LIMITED ONE-YEAR WARRANTY	40
10	CE DECLARATION	41

1 General Operating Instructions

This section describes general operating instructions that apply to all of the testing modes. Before connecting the 603B to any battery or circuit read and follow the information provided in the safety section. Verify the voltage and current is within the safe operating range of the 603B. Refer to the Specifications section.

The 603B is powered by the battery or charger circuit under test. The 603B does not have a power switch and will power on and display the voltage when the properly connected to a battery with sufficient power. If nothing is displayed or the display blinks on and off the power is not sufficient and testing cannot proceed.

1.1 Ready The 603B

1. Two types of cables are available for use with the 603B. One set is intended for smaller batteries that connect with tab type connectors and the other set has larger jaws to accommodate batteries with bolt on or clamp type terminals. Select the cable type that will make the best connection with the battery to be tested.



Tab type



Terminal type

2. Identify the cable ends with the 3-pin twist lock connector. One of the cables will have a red band on the end near the 3-pin connector. This cable will be installed in the positive side of the 603B identified with the red plus sign polarity symbol.
3. Rotate the 3-pin connector until the arrow molded into the connector is facing up and pointing toward the polarity symbol.



Connector arrow

4. Insert the 3-pin connector into the mating connector using a slight left right rotation the 3-pin connector slips in to place. The outer ring can now be rotated until the grooves align and the ring move slightly forward. Continue to gently push the connector forward while twisting the outer ring. The outer ring should easily turn clockwise $\frac{1}{4}$ turn locking the two mating connectors together. Gently pull on the shell of the connector to make sure the cable is locked into place. Install the Remaining negative cable in the same manor.
5. If the system has 2 batteries, test each battery separate.
6. The 603B use a 3 wire connection to improve accuracy. This requires both sides of the each alligator clip to make a good connection between the jaws of the alligator clip and the terminal.

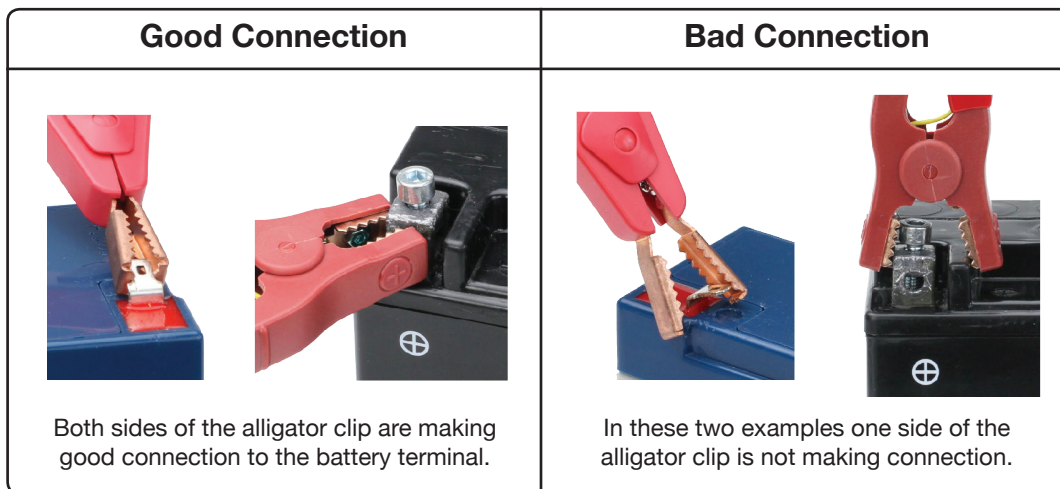

7. Connect the red cable to the positive terminal of the battery and the black cable to the negative terminal of the battery. If the Reverse Polarity LED on the front of the 603B illuminates, disconnect the battery and check the cables for correct connection. Check to see if the red and black cables have been installed in the correct location.

! CAUTION

Do not attempt to test the battery while the charger circuit is still connected.

2 Button Descriptions

This section provides an overview of each button and its description, refer to Table 1. Some buttons will have different functions additional detail is provide in the section where the button is used.

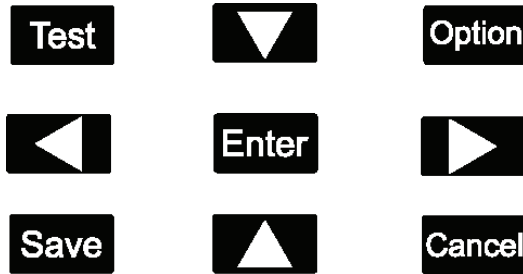









Button	Description
	Starts the test
	Opens the option menu and on-screen keyboard
	Move the cursor up one space or move to the previous page
	Move the cursor down one space or move to the next page
	Move the cursor left one space
	Move the cursor right one space
	Select the row or select a character using the on-screen keyboard.
	Save changes to the internal database memory
	Cancel the operation move back one menu level

Table 1

3 Quick Test Mode – SOC

The Quick Test mode is used to find degraded or damaged batteries quickly. The test can be configured and results viewed in a few minutes. The only information required is the battery ampere hour (Ah). This is usually found directly on the battery or the battery manufacturer's data sheet. The ampere hour setting used during the test is saved in memory. This feature supports testing batteries of the same type without the need of reentering the ampere hour value each time the meter is disconnected and reconnected. It's important to remember that the Quick Test mode does not save measurement results.

1. Disconnect the battery or batteries from the charger circuit. Dress the charger circuit leads so they do not come in contact with each other or any other conductive parts of the cabinet or control board.
2. Verify that battery voltage and Ah, is within the specifications of the 603B.
3. Connect the battery observing the correct polarity.

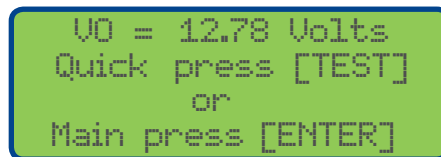

```
U0 = 12.78 Volts
Quick press [TEST]
or
Main press [ENTER]
```

Power on - Main screen

4. Press the **Test** button once to select Quick Test.

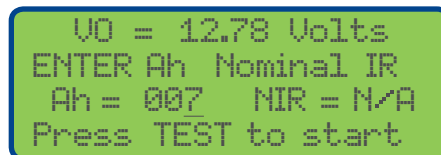

```
U0 = 12.78 Volts
ENTER Ah Nominal IR
Ah = 007 NIR = N/A
Press TEST to start
```

Quick Test setup screen

The cursor will be located in the Ah: field.

5. Use the **▲** **▼** buttons to increase or decrease the Ah: value until it matches the battery under test. The range can be set from 1 to 100 Ah. Press and hold is also supported for rapid changes.

When the Ah matches,

6. Press and release the **Test** button to start the test.

7. The back light will turn off indicating the test has started. To cancel the test, press the **Cancel** button.
8. The back light will illuminate after approximately 6 seconds and the results will be displayed.

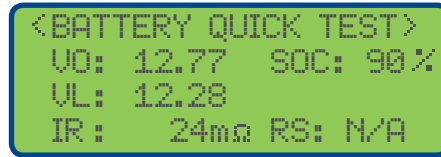

Result screen

Tip: After completing the test, the cables can be moved to a new battery of the same type.

1. Once the next battery is connected, press the **Test** button twice, press once to select Quick Test mode and again to start the test.

If the battery has a different Ah: value

2. Use the **▲** **▼** buttons to change the value followed by the **Test** button.

3.1 Quick Test Mode - Pass/Fail

The Pass/fail option compares a batteries' internal resistance to a known good nominal value and determines if the battery under test is PASS or FAIL. The Nominal Internal Resistance or "NIR" value is optional. If the NIR is set to the default of value of N/A the 603B will display RS: N/A. The NIR entered is compared to the battery under test measured IR. If the battery under test is less than or equal to 160% of the NIR value the 603B will display "RS: PASS" in the field. If the value is above 160% the 603B will display "RS: PASS" in the field.

Example: The NIR is set by the user to 23 milliohms then the threshold can be calculated:

$$160\% \times \text{NIR} = 1.6 \times 23 = 36.8$$

If the 603B measured IR is equal to or greater than 36.8 the 603B will display RS: FAIL



Three methods can be used to determine the "NIR" value to be enter.

1. Find the IR value on the battery manufacturer's data sheet.
2. Use the 603B to measure the IR of a known good battery of the same type.
3. Use another battery analyzer like the B&K Precision model BA6010 to measure batteries' IR.

Note: The known good battery should be new and made by the same manufacturer with the same model number.

1. Set the Ah value as describe in Quick Test, SOC section.
If the Ah value is correct move to the next step.
2. Press the  button to move the cursor over to the "NIR = ..." field.

The range includes N/A and 1 to 100. Press and hold is also supported for rapid changes.

3. Enter the NIR using the   buttons. Press and hold is also supported for rapid changes.
4. Press the  button to proceed.

The NIR entered is compared to the battery under test measured IR. If the battery under test is less than or equal to 160% of the NIR value the 603B will display will indicate PASS in the "RS:" field. If the value is above 160% the 603B will display will indicate FAIL. This percentage cannot be changed

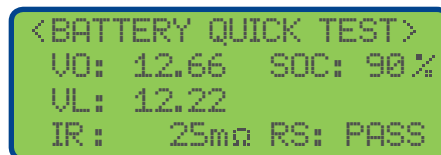

Quick test results screen

Note: The Ah and NIR values are both saved to support rapid test of several batteries of the same type.

3.2 Quick Test Mode - Charger Circuit Test

Similar to the other Quick Test modes the Charger Circuit test is a tool to help evaluate the performance of the charger circuit under an open and loaded condition. Both the open voltage OCV and LCV values are displayed. The load applied is based on the Ah value entered and is calculated to place a light load that should be will within the nominal range of the charger circuit. Although the 603B does not test 24 volt batteries it can test most 24 volt charger circuits.

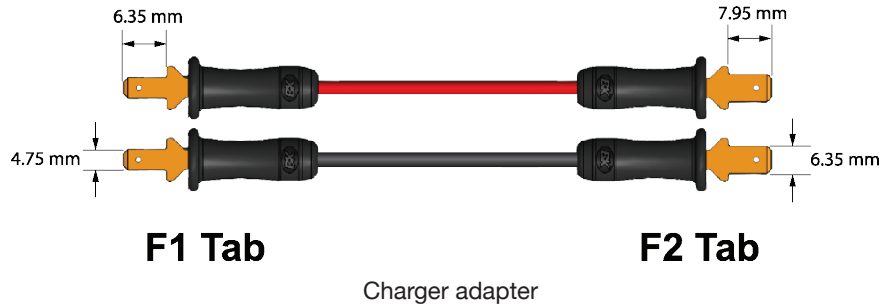

An adapter is provided with an F1 tab on one end and F2 tab on the other. Using the correctly sized tab, plug one end of the adapter into the leads of the system charger circuit. The other end of the adapter is used for an attachment point for the 603B tab type, alligator clips.

1. Connect the 603B cables and verify the positive and negative leads are correct and the Reverse Polarity LED is not illuminated.

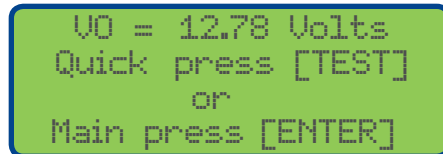

2. Press the **Test** button to move to the Quick Test menu.

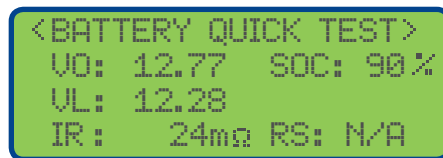

3. Press the **Option** button to access the <CHARGER QUICK TEST> mode

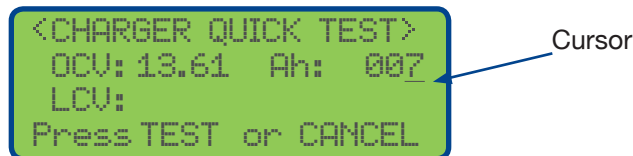

The cursor (underline) will be located in the Ah: field.

4. Use **▲** **▼** buttons to increase or decrease the Ah: value until it matches the battery under test Ah.

5. Press the **Test** button to begin the test. The back light will turn off indicating the test has started. After approximately 2 seconds the back light will illuminate and the results will be displayed.

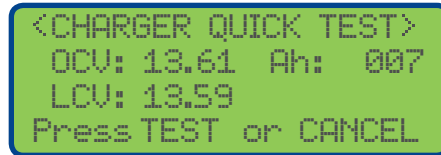

```
<CHARGER QUICK TEST>
OCV: 13.61 Ah: 007
LCV: 13.59
Press TEST or CANCEL
```

Both “OCV:” and “LCV:” will be measured and displayed. If the LCV voltage is significantly below the OCV: the voltage charger circuit could have a problem. Contact the control panel (charger), manufacturer for more information.

The back light will turn off indicating the test has started.

Both the open voltage OCV: and the loaded voltage LCV: are displayed. If the LCV drops will below the OCV value the charger circuit regulator could be faulty. The results of the test must be interpreted by the technician as each type of charger circuit is different. Contact the charger circuit manufacture for more information.

Tip: In a two battery system use the Ah value of one battery. Example, a fire alarm control panel has two 12 V batteries connected in series to provide the FACP with 24 volts. The charger circuit in the FACP is designed to charge at just over 24 volts. The 603B will use this Ah value of one of the batteries to calculate and apply a parcel load on the charger circuit.

4 Main Menu

The Main menu provides access to Record Mode, additional test tools and system configuration.

1. Connect the 603B and verify the displayed voltage is in range.

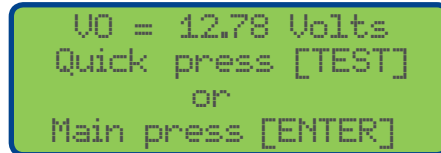

Power on menu

2. To access the Main menu level by pressing the **Enter** button



Main menu

The Main menu has four options available. Each of these options is explained below in more detail.

4.1 View/Edit Records

To view or edit an existing record in the 603B memory.

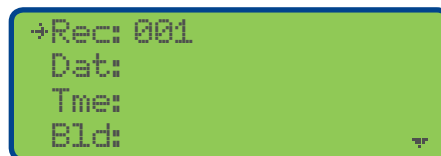

1. Power on the 603B.
2. Press the **Enter** button to select the Main Menu.
3. Use the **▲** **▼** buttons to move the pointer to the row "View/Edit Records" and press the **Enter** button.

The 603B will display the first record in the database in this example, record 001 with no data in the record.





Record view

To view a specific record in the database.

4. Press the  button to move the cursor over to the Record number field.
5. Press the   to increment or decrement through the existing records.

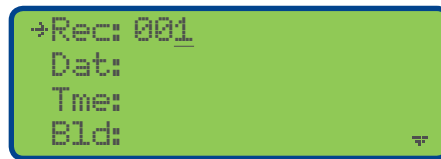

If the record exists the record will be displayed on the screen. If the record exists but is empty you will only see the field labels with no data in the field. The 603B will step through all the records in memory and start over.

6. To edit the record field, use the   buttons to move the pointer to the row to be edited.
7. Press the  button to move the cursor in to field. If the cursor does not move in to the field this field cannot be modified. In the example shown, Dat: and Tme: are system type fields and cannot be modified. The Bld: field can be edited and the on screen keyboard will be displayed when in the edit mode. See Database record format and on-screen keyboard for more information.



Record View example

4.2 Record Indicators

The small arrow “Item selector pointer” in the top left corner of the example screen is used to select a row or move to another screen. This indicator is moved up or down the left side of the screen using the   buttons.

Another indicating arrow is displayed in the lower right corner pointing down. This arrow indicates additional items are located on the screen below. When both arrows are showing at the same time additional items are on screens above and below. An arrow in the top right pointing up indicates additional items are on the screen above.

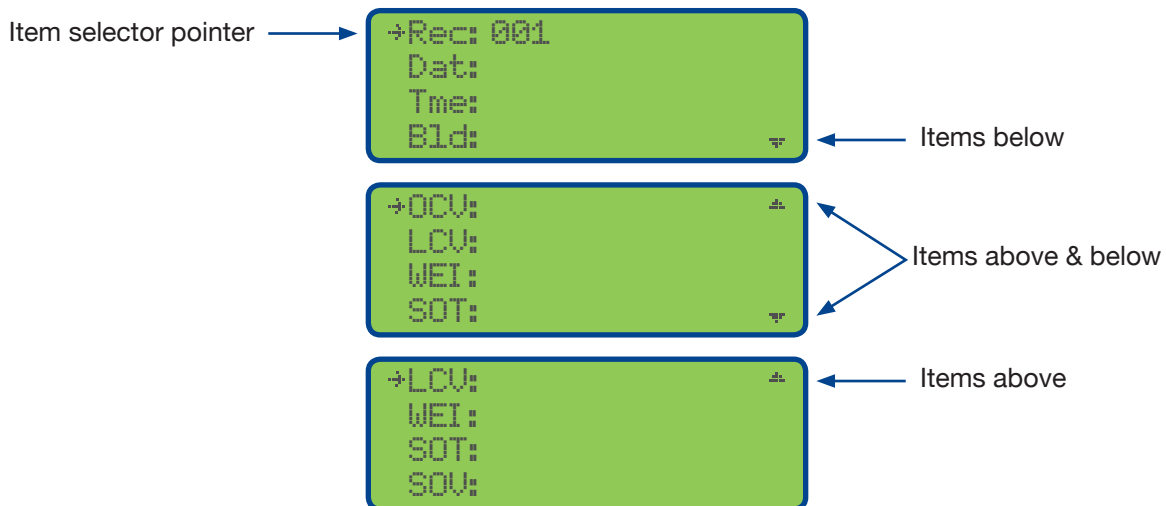

Indicators

4.3 Database Record Format

The 603B can store up to 50 records in the internal memory. Existing records can be selected, viewed and edited. A new 603B will have only one record number 001 in memory. This record will have no data in the fields also called a blank or empty record. You can use the View/Edit Records to add information in the User editable fields.

Each record contains 31 fields refer to table 2 for more details. The first column, Displayed Field shows the mnemonic label as displayed on the 603B. The second column provides clarification of the mnemonic label. The third column provides information about the type of data that is stored in the field and the last column describes the size and format.

The only fields that can be edited by the user are Data Type, “User”. All the other fields in the record are controlled by the 603B system and cannot be edited by the user.

Displayed	Field	Data	Size
Rec	Record	System	2 digits, numeric, 50 records
Dat	Date	System	yyyy/mm/dd
Tme	Time	System	hh:mm:ss, 24 hour
Bld	Building	User	13 character, alphanumeric
Loc	Location	User	13 character, alphanumeric
Typ	System type, see table 3	User	1 character, predefined
Ser	Battery Serial Number	User	13 character, alphanumeric
Mfd	Battery Manufacturer	User	13 character, alphanumeric
Tmp	User provided temperature	User	2 digits, degrees C
V	Battery voltage (as labeled)	Measurement	4 digits, numeric
Ah	Battery Ampere Hour (as labeled)	User	2 digit, numeric
VO	Voltage Open	Measurement	4 digit, numeric
VL	Voltage Loaded	Measurement	4 digit, numeric
RC	Remaining Capacity	Measurement	4 digit, numeric
NIR	Nominal internal resistance used for test	User	3 digit, N/A or 001 to 199
IR	Measured internal resistance used for test	Measurement	2 digit, numeric
OCV	Open Charger Voltage	Measurement	4 digit, numeric
LCV	Loaded Charge Voltage	Measurement	4 digit, numeric
WEI	SOC Table used for test	System	On/off
SOT	SOC table used for test	System	12V = D,1,2,3 and 6V = d, 4,5,6
SOV	SOC voltage used for test	System	Voltage from SOC table used

Table 2

4.3.1 System type field

Knowing the system type is helpful for sorting and evaluating the batteries' life cycle. The system type options are identified with a letter and described in table 3. This field is not a required and can be left blank.





Typ	Description	Prompt
A	Access Control	Yes
B	Backup	Yes
C	CCTV	Yes
L	Exit Light	Yes
F	Fire Control Panel	No
R	Fire Control Panel Charger	Yes
E	Fire Extender Panel	No
X	Fire Extender Panel Charger	Yes
S	Security	Yes
U	UPS	Yes
O	Other	Yes

Table 3

The 603B displays a reminder prompting the user to test the charge circuit after some tests. To keep the 603B from prompting twice in a two battery system like fire alarm, system types F and E are used. The prompt is not displayed for system types F and E as this step will be performed after battery types R and X are tested.

The 603B will display the battery serial number stored in the record to make it easy to verify the correct battery will be tested.

4.3.2 On-screen keyboard

Some of the user editable fields except alphanumeric characters. The 603B will switch to edit mode displaying the on-screen keyboard for any alphanumeric field. The label at the top of the screen and keyboard for selecting letters numbers and symbols. The     buttons are used to move the cursor.

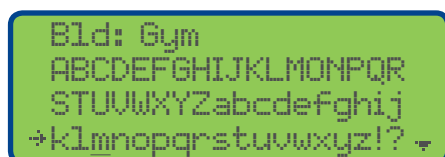

On screen keyboard 1 of 2

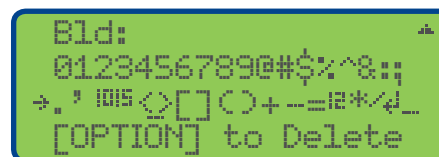



On screen keyboard 2 of 2

1. Use the **Enter** button to select a character and the **Option** button to delete a character. As each character is selected it will show at the top of the screen.
2. Press the **Save** button to accept the edits.
3. Press the **Cancel** button to discard all changes and return.
4. When the pointer is located on a "User" editable field, press the right arrow key to move the cursor in to the field this will enable editing mode.

4.3.3 Numeric type fields

If the field has numeric digits it can be changed by

1. Pressing the   arrow buttons.
2. Press and hold is also supported to increment and decrement the values quickly.
3. Press the **Save** button to save the changes in the database or the **Cancel** button to exit without saving.

4.4 Add New Record

The new blank record can be added to the database if the database is not full.

1. From the Main menu use the   buttons to navigate to the Add New Record.



2. Press the **Enter** button to select and add the new record.

Example: If the 603B has 11 records and a new record is added it will be assigned to the next logical memory location in this example, 012.

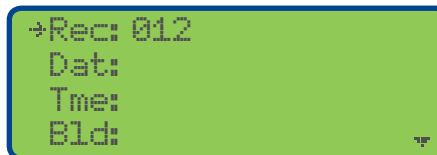



3. Press the **Save** button to keep this new blank record. If desired continue adding information to the record fields.

Tip: Be sure to press the **Save** button or the changes will be lost.

Tip: It is much easier to add, edit and arrange new records with a computer and the included application software

4.5 Load Test

The Load Test mode allows the user to set the load current and the duration for testing control panel output circuits.

1. From the Main menu use the   buttons to navigate to the Load Test and press the Enter button.



- The Load Test will open with the cursor located in the Load Current, LC: field. Press the **▲** to increase the current **▼** to lower the value.
- Press the right arrow key to move to the Load Time field LT: the cursor will move to this increase or decrease the LT time.
- Press the **Test** button to start. The display back light will be turned off during the test. Press the Cancel button to stop the test.

```

LC:10.0A  LT:5.0sec
VO:--.--V  UC:--.--V
  Arrow Keys to Set
  TEST Key to Test

```

- When complete the display back light will illuminate and the voltage open VO: and voltage loaded, VL: will be displayed.

```

LC:10.0A  LT:5.0sec
VO:12.79V  UC:11.91V
  Arrow Keys to Set
  TEST Key to Test

```

The 603B uses internal temperature sensors to automatically control the cooling fan speed. It is normal for the fan to turn on, speed up and turn back off based on usage.

Tip: The System menu allows the user to manually turn on for testing or additional cooling.

4.6 System

The System menu is used to view and change the 603B system configuration. This section describe each of these settings. The System menu is accessed from the Main menu.

- Power up the 603B, press the **Enter** button. Five rows are presented on the Main Menu.
- Use the **▲** **▼** keys to move the point to the “Systems” row and press the **Enter** button.

```

View/Edit Records
Add New Record
Load Test
+System







```

Main Menu level

4.6.1 Setting date

The date needs to be set when the 603B is new or has been factory restored. The date is recorded in the database after each test when using Record Mode.



To set or change the date

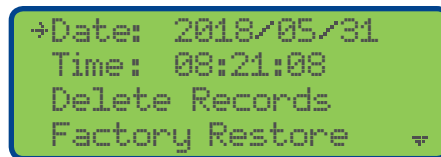



1. Use the   buttons to move the pointer to the “Date:” row.
2. Press the  button to advance the cursor to the year field, Month or day field with each press.
3. Use the   buttons to increment or decrement the values in the field.
4. When finished, press the  button a few times to move the cursor back to the row. The row point will show and the new date will be saved.



Selecting the Date: row

4.6.2 Setting time

The time needs to be set when the 603B is new or has been factory restored. The time is recorded in the database after each test when using Record Mode. To change the time, use the   buttons to move the pointer to the Time: row.

1. Press the  button to advance the cursor to the hours, minutes, or seconds field with each press. Use the   buttons to increment or decrement the values in the field.
2. When finished, press the  button a few times to move the cursor back to the row. The row point will show, the new time will be saved and the seconds will begin to change.



4.6.3 Deleting records

The 603B provides tools to delete one, some of the records or all records in memory. Each of the options is explained in this section. Records can also be deleted using the application software and computer.

Tip: Backup the records on the computer before making changes to the 603B database



4.6.3.1 Delete one record

To delete one specific record in the 603B memory, power on the 603B and press the  button to select the Main Menu.

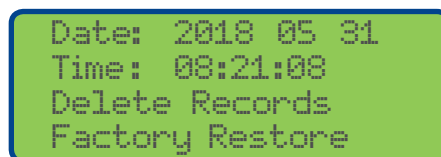
1. Use the   buttons to move the pointer to the last row called “System” and press the  button.



Delete Records

- Use the   buttons to move the pointer to “Delete Records” and press the **Enter** button.



```
→Del. One Record
Del. Records
Del. All Records
```

Delete record options

A new menu will show with three rows of delete options. The pointer will be located on the first row “Del. One Record”.

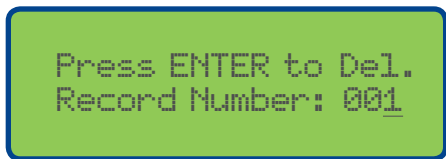

- Press the **Enter** button to select this option.



```
Press ENTER to Del.
Record Number: 001
```

Delete record screen

A new screen will be displayed with the cursor located in the Record Number: field.

- Use the   buttons to increment or decrement the record value to be deleted.
- Verify this is the correct record to be delete and press the **Enter** button. The record will be deleted immediately without a confirmation.

Note: The data in the record is deleted the blank record is keep to keep the record positions in the correct order.

4.6.3.2 Delete range of records



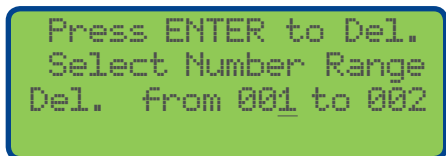

To delete a range of records in the 603B memory,

- Power on the 603B and press the **Enter** button to select the Main Menu.







```
Press ENTER to Del.
Select Number Range
Del. from 001 to 002
```

Delete range

- Use the   buttons to move the pointer to the last row called “System” and press the **Enter** button.
- Use the   buttons to move the pointer to “Delete Records” and press the **Enter** button.

The display will show a cursor located in the “from” field.

4. Use the   to increment the number to the first record to be deleted.
5. Press the  button to move to the cursor to the last record number field.
6. Use the   to increment the number to the last record in the range to be deleted.
7. Verify the range of records is correct as all the records in this range will be deleted.
8. Press the **Enter** button. The records will be deleted immediately without a confirmation.





If the 603B displays “Out of Range” the range is not correct. The starting range must be less or equal to the ending range value.

4.6.3.3 Delete all records

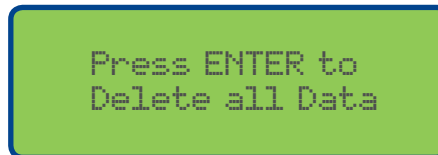
To delete all records in the 603B memory,

1. Power on the 603B and press the **Enter** button to select the Main Menu.



2. Use the   buttons to move the pointer to the last row called “System”
3. Press the **Enter** button.
4. Use the   buttons to move the pointer to “Del. All Records”.
6. Press the **Enter** button to delete all records.





The records will be deleted immediately without a confirmation.

4.6.4 Factory Restore

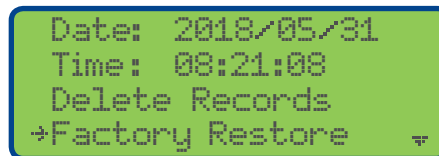
To restore the 603B factory settings and erase all memory,



1. Power on the 603B and press the **Enter** button to select the Main Menu.

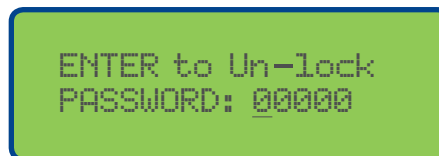

2. Use the   buttons to move the pointer to the last row called “System”
3. Press the **Enter** button.
4. Use the   buttons to move the pointer to “Factory Restore” and press the **Enter** button.



A new screen for entering the password will be displayed. The password is 13579. The cursor will be located at the first digit of the password.

5. Use the  buttons to increment this digit to 1
6. Press the  button to move to the next digit and increment this digit to 3.
7. Proceed in complete all for digits until 13579 is showing in this field.
8. Press the  button to proceed. A confirmation screen will be presented providing the option to proceed or cancel.

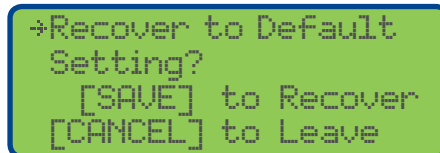

```
+Recover to Default
Setting?
  [SAVE] to Recover
  [CANCEL] to Leave
```

9. Press the  button, all records will be deleted and the settings will be restored to factory settings. This process will also erases the calibration file and returns the 603B to a default base calibration. Calibration can only be recovered if the last calibration file for the specific 603B was saved and available. If not the 603B should be re-calibrated following the process in the Calibration section.

4.6.5 Calibration

The calibration section on page 30 describes the process and equipment needed to calibrate the 603B. The calibration process is made up of several sections. All sections should be completed in full. Read the enter calibration section before attempting.

4.6.6 SOC Profile Settings

This section describe the steps used to create a User defined SOC table. The values in the table are used to calculate the remaining battery capacity. The 603B includes two default profile tables one for 6 volt and 12. These two profiles cannot be modified and are suitable for most SLA battery applications. The 603B also has six user editable SOC profiles three for each voltage.

During the SOC test (record mode), the 603B will record several useful measurements a few of these are intended to help the user evaluate the battery life cycle and performance over time.

SOT, the table used during the test. The table used is set in the "SOC Selection

VO, open voltage, used to lookup the value in the SOC table.

SOV, the voltage value found in the lookup table.

Remaining capacity (RM) as a percentage.

Tip: To avoid confusion in the battery history record the user must use caution when working with User defined SOC tables. Keep records of each SOC table generated and when it was put in to use can help users better understand the battery history. For most users the default SOC tables are recommend.

1. Power on the 603B.
2. Press the **Enter** button to select the Main Menu.
3. Use the **▲** **▼** buttons to move the pointer to the row “System” and press the **Enter** button.
4. Use the **▲** **▼** buttons to move the pointer to the row “SOC Profile Settings” and press the **Enter** button.

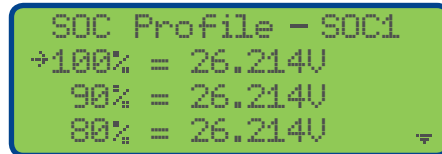

Selecting a profile

The pointer will be located at the row “Setting 12 V SOC #1” by default. The settings continue to the next screen. A total of 6 profiles can be edited and stored. 3 profiles for both 12 and 6 volt ranges.

For this example the default row selected, “Setting 12V SOC #1 opening the profile view and edit screen.

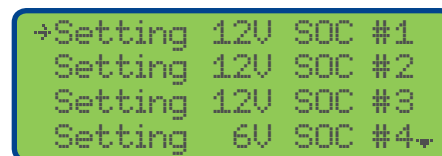

View and edit profile

Each profile will have 11 rows stating at 100% and ending at 0%.

1. Use the **▲** **▼** buttons to move the pointer to the desired percent % row and press the **▶** button to move the cursor in the voltage field and enable editing. The **▶** and **◀** buttons can be used to position the cursor under the digit to be changed.
2. Use the **▲** **▼** buttons increment or decrement the digit.
3. When finished editing the digits press the **◀** button a few times to return the cursor back to the row and the select pointer showing.
4. Repeat steps 1 through 3 until all 11 rows have edited.
5. Verify all the 11 rows of enters are correct.
6. Make sure the row pointer is showing and press the **Save** button.



If an “Out of Range” is displayed the SOC table was not entered correctly and values must be corrected and reentered.

Note: The SOC Selection is closely related to this section.

4.6.7 SOC Table Selection

This section describes how to set the SOC table used during both Quick Test mode and Database Mode. The 603B is set to the default SOC tables signified by the letter d for 6 volt and D for 12 volts.

1. Powered on the 603B.
2. Press the **Enter** button to select the Main Menu.
3. Use the **▲** **▼** buttons to move the pointer to the row “System” and press the **Enter** button.







4. Use the   buttons to move the pointer to row “SOC Selection” and press the **Enter** button.

```

→Quick  12V SOC = D
Quick   6V SOC = d
Record  12V SOC = D
Record   6V SOC = d

```

SOC select

5. Use the   buttons to move the pointer to select a row for the test mode and voltage desired and press the  button to move the cursor in the field and enable editing.
6. Use the   buttons to step through the options. 12V has the options: D, 1,2 and 3 while 6V has the options: d,4,5,6. The letters “D” and “d” are default system SOC profiles. The numbers are reserved for user created SOC profiles.
7. When the desired option is showing press the  button to return the cursor back to the row with the select pointer showing.
8. Press the **Cancel** Button this will also save the changes and move back one menu level.

4.6.8 Back Light

The back light can be toggled On/Off by moving the pointer to this row and pressing the **Enter** button. Each press of the button will toggle the On/Off state.

```

Calibration      →
SOC Profile Setting
SOC Table Selection
→Back Light On  ←

```

When the Back Light is set to On, the back light stays on indefinitely except during load test.

Note: This will place a continues drain of approximately 45 milliamps until the battery is totally discharged.

When the Back Light is set to Off, the back light stays on except during load test and will turn off after 60 seconds of inactivity.

4.6.9 SOC Weighting

The SOC weighing can be toggled on/off by moving the pointer to this row and pressing the **Enter** button. Each press of the button will toggle the on/off state.

```

→SOC Weighting On →
Firmware Version
Fan Start

```

Weighting is an estimating method used to provide a more useful representation of the batteries' State of Charge (SOC). The user must provide the nominal internal resistance (NIR) value for this feature to function. NIR can be entered in the Quick test mode for using during the Quick test or added to the record for use in Record Mode.

When SOC Weighting is turned off the 603B calculates the SOC using the same method as a volt meter and an SOC chart. The batteries open terminal voltage and a lookup table in memory is used to find and estimate the batteries remaining capacity. If SOC Weighting is On the IR and NIR are compared and if the measured IR is not equal to NIR the remaining battery capacity displayed is reduced. Increased battery IR is a normal part of the battery aging process. The weighting algorithm used in the 603B is suitable for most SLA type batteries used in the alarm, CCTV, and access control industries.

Three methods can be used to determine the "NIR" value to be enter.

1. Find the IR value on the battery manufacturer's data sheet.
2. Use the 603B to measure the IR of a new battery.
3. Use another battery analyzer like the B&K Precision model BA6010 to measure batteries' IR.

Note: The known good battery should be new and made by the same manufacturer with the model number.

4.6.10 Firmware Version

To view the firmware version,

1. Move the pointer to this location and pressing the **Enter** button.

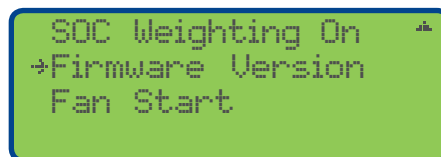

2. Press the **Cancel** Button to return.

4.6.11 Fan Start

The fan start is used to test and verify the fan is functioning correctly. The 603B has an internal temperature sensors. The system will turn on the fan and adjust the speed automatically.

To enable the fan start

1. Move the point to the Fan Start row and press the **Enter**.

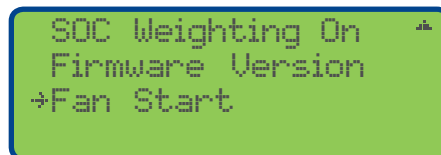

The fan will start immediately and "Starting Fan Process" screen will be displayed using a 5 minute countdown timer. The countdown timer is not adjustable.

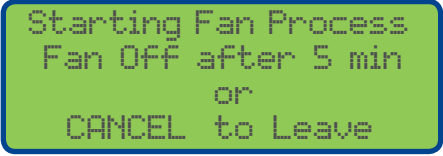

```

Starting Fan Process
Fan Off after 5 min
      or
CANCEL to Leave
  
```

2. Press the **Cancel** button to stop the end the Fan test early and return.

Tip: In hot environments with repeated load testing the outside case of the 603B may become uncomfortable hot. This Fan Start feature can be used to help cool the 603B. Load testing should be delayed until the 5 minute timer shuts off the fan. If the case is still hot repeat the Fan Start process.

4.7 Record Test Mode

Record Mode testing is used to test the battery and charger circuit and record the resulting in to the 603B memory. The 603B can store information about the battery, system type, site location and more. See *Database Record Format* section for more details. The minimum requirement to complete a test in this mode is battery Ah:

To enter the Record Test mode and compete a test,

1. Power up the 603B, press the **Enter** button.

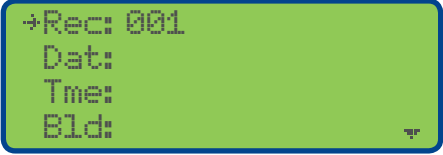

```

+Rec: 001
Dat:
Tme:
Bld:
  
```

Record number

2. Press the **Enter** button.
3. If the 603B is displaying the correct record number.
 - a. Verify the battery serial number.
 - b. Press the **Enter** button again to start the test.
4. To select a different record number press the **▶** button to move the cursor into the record number field.
 - a. Use the **▲** **▼** to step to the desired record number.
 - b. Verify the battery serial number.
 - c. Press the **Test** button again to start the test.

The display back light will turn off indicating the test is in process. After a few seconds the results will be displayed. A charger circuit test reminder may show on the display for a few seconds.

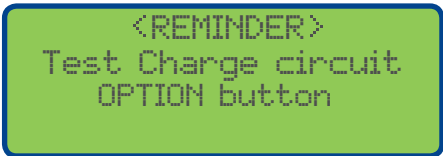

```

<REMINDER>
Test Charge circuit
OPTION button
  
```

Reminder

```

Adjust TMP: 27
V0: 12.79 SOC: 90%
UL: 12.91 TMP: 25
IR: 24mΩ RS: N/A

```

Temperature adjustment

5. Keep the default temperature value or use the ▲ ▼ to adjust the temperature to record a more accurate battery environment. This information is not used in the 603B calculations this is only stored in the database record for future analysis by the user.

Tip: Use a none contact thermometer to measure the battery temperature for more accurate database record.

6. Press the **Save** button to save the changes to the 603B memory. The 603B will respond with the message “Data Saved”.
7. To test the charger circuit press the **Option** button and follow the on-screen instructions. The test leads can be removed from the battery and reconnected to the charge circuit.
8. Press the **Cancel** button or simple disconnect the 603B to move to the next battery test or location.

Tip: For multiple site or multiple systems, build the record files in the same order you will be completing the tests in the field.

4.8 Record Mode Charger Circuit Test

The record mode charger circuit test works the same as in the Quick Test mode with the difference being the test results are saved in the record. The 603B will remember the last record in use to allow the user to move the battery cable from the battery to the charger circuit.

A Charger Circuit test is completed while in Record mode following a battery test. The 603B will display a brief reminder.

```

<REMINDER>
Test Charge circuit
OPTION button

```

Reminder message

If the temperature is to be adjusted, make this adjustment before starting the charger circuit test.

1. Press the **Option** button to access the <CHARGER TEST> mode.

```

Disconnect battery &
connect charge
Circuit. Press TEST
when ready

```

Disconnect battery message

2. Disconnect the 603B from the battery. The 603B will remember the record in use and return to this record when power is restored ready to test the charge circuit.
3. Connect the 603B cables and verify the positive and negative leads are correct and the Reverse Polarity LED is not illuminated. Use the Tab type adapters if required.

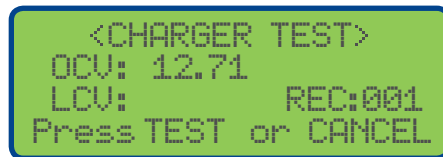
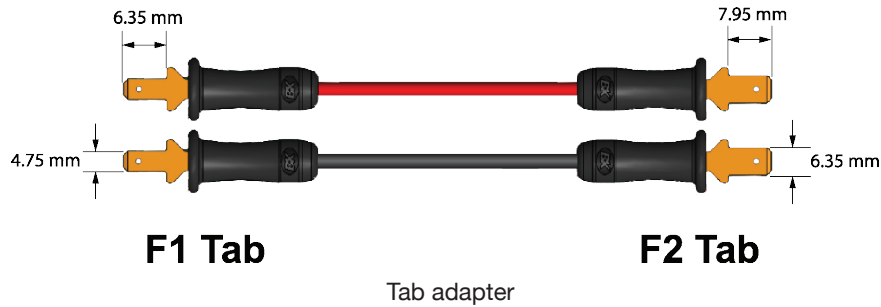

Charger screen

4. Verify the OCV: voltage in the expected range.
5. Press the **Test** button to begin the test. The back light will turn off indicating the test has started. After a few seconds the back light will illuminate and the results will be displayed.

The 603B will display the “OCV:” and “LCV:”. The measurements will also will be stored in the record.

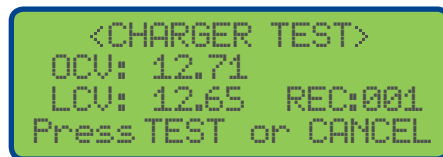

LCV: Values after the test



Measurements stored in the record

6. Press the **Cancel** button to move back to the Record view mode.
7. Press the **▼** button to advance to the next record or press the **Cancel** button to move back to the Main menu.

5 Firmware Update Procedures

5.1 Firmware Update Instructions

The following section describes the steps to complete a firmware update. The steps include:

1. Downloading and installing the firmware application software called “Bootloader”.
2. Connecting the 603B to the computer.
3. Updating the firmware.
4. Restoring the calibration data.

Downloading the Software

The Bootloader has been tested on Microsoft Windows 7 and 10.

Download the application 603B_Bootloader v1.07 from the bkprecision.com website.

This file is zipped be sure to unzip the file before attempting to launch the application.

Right click the application and select Run as Administrator. The following screen will be displayed.

Connecting the computer

The 603B does not require a battery or power supply for this process. The 603B internal processor will be powered by the USB port. The display on the 603B will not be enabled during this operation.

Connect the computer to the 603B using a type B USB cable.

Updating the firmware

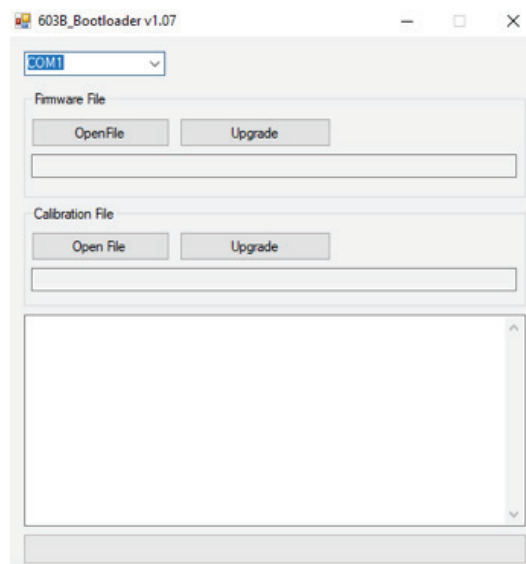

After the application launches, change the default COM1 to match the COM assigned by the operating system. To find the correct COM, click the down arrow to open the COM port selection.

Unplug the 603B from the USB port and observe which COM port disappears.

Plug the 603B back in, open the COM selection and select this COM port from the list.

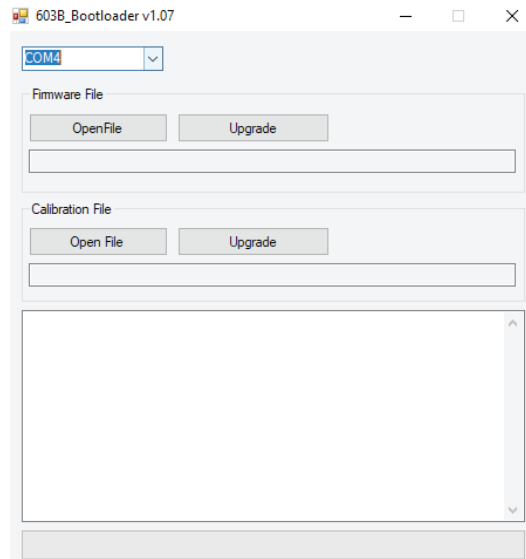

In this example the operating system assigned COM4 your system may assign a different COM.

1. Under the heading Firmware File, click on the Open File button.
2. Select the text file FW 1.xx.txt where xx is the correct firmware revision.

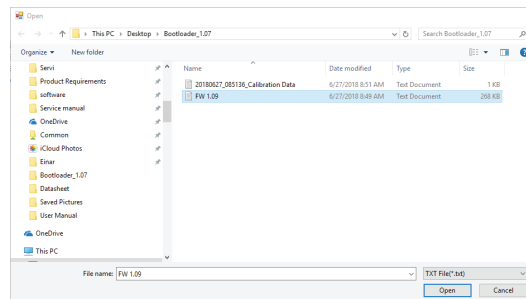

3. The path to the firmware selected should now show at the top of window.
4. Click the Open File button.

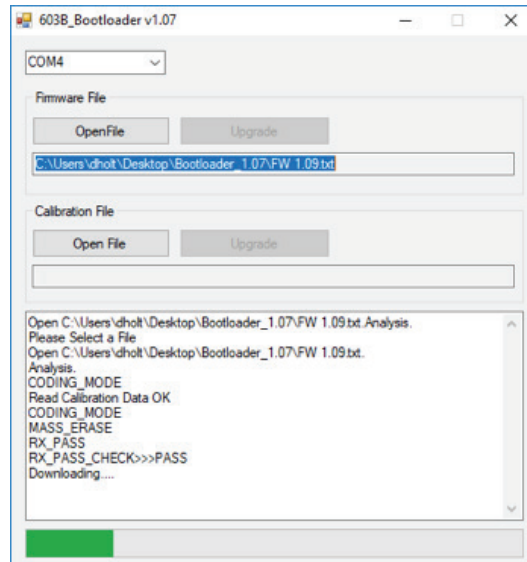

The green progress bar will advanced as the memory is updated and log messages will be displayed.

The existing calibration data will be read from the 603B.

The log will display “Read Calibration Data OK”.

This file will be automatically saved on the host computer with a file name containing “.....Calibration Data.txt”. This file will be used in the Restoring Calibration steps.

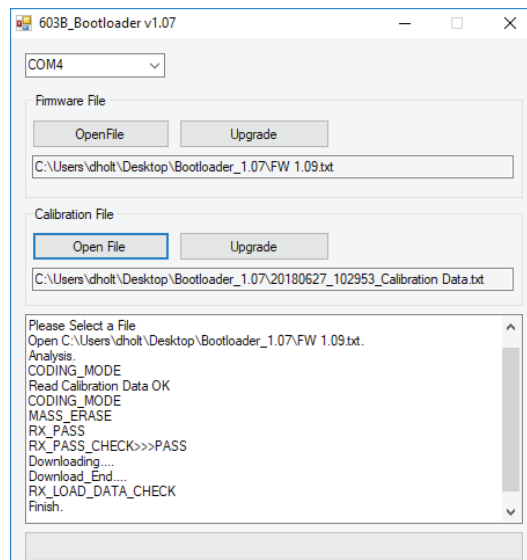

The bootloader window will display Finish when the update is complete.

5.2 Restoring the Calibration Data

The calibration data now needs to be restored. This step is recommended even if you plan to complete the calibration process after the firmware update.

1. Under the section “Calibration File”, click the Open File button.
2. Find the file “.....Calibration Data.txt” create in the previous steps verify the date and time the file was created and select it. The file path should now show in the Calibration File window.
3. Click the upgrade button to start the process.
4. A warning message will now be display click the Yes button.

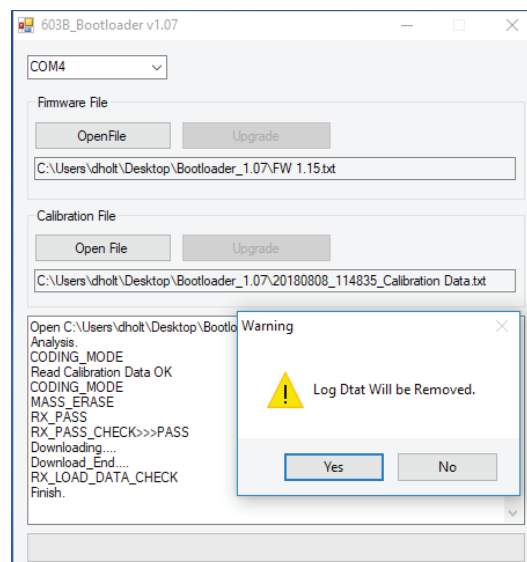

5. This procees will be followed by a notice to “Please Reinsert the USB cable”. This should read Remove and reinsert the USB cable.

6 Calibration Procedures

The calibration section describes the process and equipment needed to calibrate the 603B. The calibration process is made up of several sections. All sections should be completed in full. Read the enter calibration section before attempting.

6.1 Equipment

An adjustable DC power supply is required to complete the calibration. The power supply must be capable of 32 volts and 12 amps with programming and readback resolution with a minimum of two digits to the right of the decimal point. The B&K Precision Model 9202 is recommend.

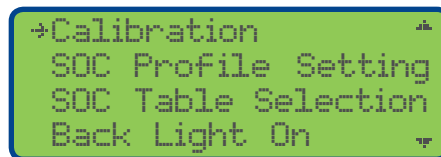

Calibration screen

To start the calibration process:

1. Connect the 603B to the specified power supply. The 603B uses a three wire connection for both positive and negative cables. Both sides of the alligator clip must make a good connection to the power supply terminals.
2. Set the power supply 12.000 volts and 2.000 A
3. Enable the power supply output and verify the 603B powers up. The displayed voltage is should be between 9 to 13 volts as the unit is not calibrated at this point.
4. Press the **Enter** button to select the Main Menu.
5. Use the **▲** **▼** buttons to move the pointer to the last row called “Calibration” and press the **Enter** button. The password screen will be displayed.

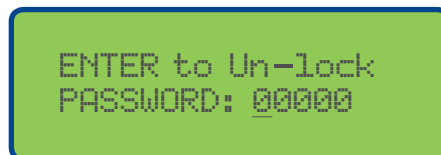

Password screen

6. The password is 13579. The cursor will be located at the first digit of the password. Use the **▲** buttons to increment this digit to 1 and press the **▶** button to move to the next digit and increment this digit to 3. Proceed in complete all for digits until 13579 is showing in this field.
7. Press the **Enter** button to proceed. The603B will display the three part calibration screen. The pointer will be located on the first row “Voltage Calibration”.

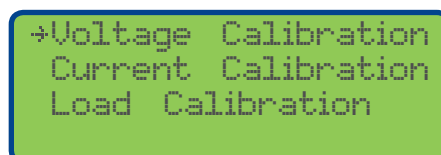

Voltage calibration

8. Press the **Enter** button to proceed to voltage calibration.

6.2 Voltage Calibration

This section describes how to calibrate the voltage. The label is easy to confuse as V_Min_1 is similar to V_Med_1 carefully match the values in the tables to the label on the 603B at each step.

From table XXX find the voltage for V_Min_1 of 5.40 V and set the power supply to this voltage.

603B Row Label	Voltage Setting
V Min 1	5.40 V
V Med 1	8.00 V
V Max 1	18.00 V

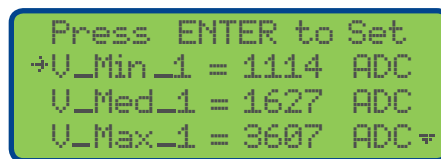

Voltage screen 1 of 2

9. Verify the pointer is located at the first row “V_Min_1 ...”
10. Press the **Enter** button to set the ADC offset. The normal function is the 4 digit value after the equals sign will change. It is also normal if this value does not change as correction was not required.
11. From table xxx find the next voltage for V_Med_1 of 8.00 V.
12. Move the pointer to the next row down “V_Med_1...” and press the **Enter** button.
13. Continue the same process for the Remaining voltage settings until all 6 volts have been calibrated.
14. Continue to the Current calibration section

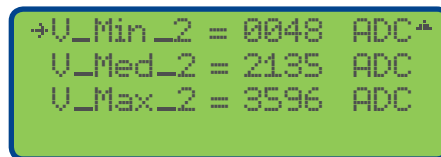

Voltage screen 2 of 2

603B Row Label	Voltage Setting
V Min 2	15.00 V
V Med 2	25.00 V
V Max 2	32.00 V

6.3 Current Calibration

15. From the 3 part calibration screen move the point to the row “Current Calibration”.

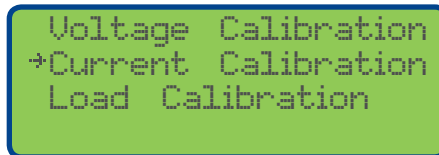

```
Voltage Calibration
→Current Calibration
Load Calibration
```

16. Press the **Enter** button to select current calibration.
17. Set the voltage on the power supply to 12.000 volts.
18. Set the current on the power supply to 12.000 amps.
19. Set the power supply to Meter mode so the current can be monitored.
20. Verify the pointer is located on the first row, “I_Min...”

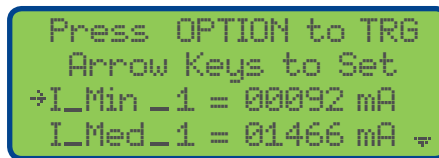

```
Press OPTION to TRG
Arrow Keys to Set
→I_Min_1 = 00092 mA
I_Med_1 = 01466 mA ▾
```

Current Calibration 1 of 4 screens

The next few steps are used to calibrate the 603B current 12 calibration points are used over 3 screen views.

21. The **Option** button is used to trigger the 603B placing a load on the power supply. Monitor the maximum current used as displayed on the power supply current meter. Make note of the maximum value. Enter this 4 digit value in the row. Repeat until all 12 calibration points are adjusted. Note that the value in the 603B display is in mA and most power supplies display in amps so a conversion will be required.
22. When ready, press the **Option** button to trigger the 603B.
23. Use the **▶** button to move the cursor into the current field and enter the max current displayed on the power supply.
24. Repeat these steps until all 12 current values have been calibrated. Note this is spread across 4 separate screens.

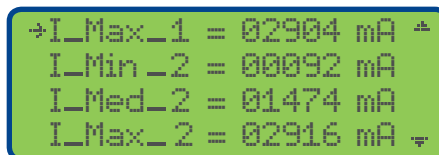

```
→I_Max_1 = 02904 mA ▲
I_Min_2 = 00092 mA
I_Med_2 = 01474 mA
I_Max_2 = 02916 mA ▾
```

Current Calibration 2 of 4 screens

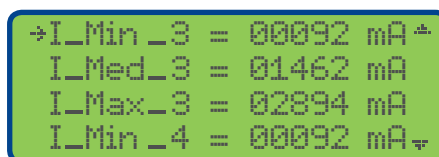

```
→I_Min_3 = 00092 mA ▲
I_Med_3 = 01462 mA
I_Max_3 = 02894 mA
I_Min_4 = 00092 mA ▾
```

Current Calibration 3 of 4 screens

```

→I_Med_4 = 01462 mA±
I_Max_4 = 02896 mA

```

Current Calibration 4 of 4 screens

6.4 Load Calibration

This is a similar process to Current calibration with only 3 calibration points. The **Option** button is used to trigger the 603B placing a load on the power supply. Monitor the maximum current used as displayed on the power supply current meter. Write the maximum value down. Enter this 4 digit value in the row. Repeat until all three calibration points are adjusted. Note that the value in the 603B is in mA.

From the 3 part calibration screen move the point to the row "Load Calibration".

25. Press the **Enter** button to select Load calibration

```

Voltage Calibration
Current Calibration
→Load Calibration

```

26. When ready, press the **Option** button to trigger the 603B.

27. Use the **▶** button to move the cursor into the Load field and enter the max current displayed on the power supply.

28. Repeat these steps until all Min, Med, Max current values have been calibrated. Note this is spread across 2 separate screens.

```

Press OPTION to TRG
Arrow Keys to Set
→I_Min = 00323 mA
I_Med = 07869 mA

```

Load Calibration 1 of 2

```

→I_Max = 11350 mA ±

```

Load Calibration 2 of 2

29. Complete a fan test and verify the 603B fan runs smoothly.

30. Create a calibration label and apply to the 603B.

The Calibration procedure is complete.

7 Specifications

603B			
Displayed			
Quick Test Mode	VO	Voltage open	
	VL	Voltage loaded	
	IR	Internal resistance	
	SOC	State of charge percentage	
	RS	Resistance status, pass/fail user configured	
Record Mode	VO	Voltage open	
	VL	Voltage loaded	
	IR	Internal resistance	
	SOC	State of charge percentage	
	SOT	SOC table used for test	
	Tmp	User provided temperature	
	RS	Resistance status, pass/fail user configured	
Recorded			
Data	Rec	Record number	
	Dat	Date	
	Tme	Time	
	Bld	Building	
	Loc	Location	
	Typ	Type of system	
	Ser	Battery serial number	
	Mfd	Battery manufacturer or in-service date	
	Tmp	User provided temperature	
	V	Battery voltage (as labeled)	
	Ah	Battery ampere hour (as labeled)	
	VO	Voltage open	
	VL	Voltage loaded	
	RC	Remaining capacity (SOC)	
	NIR	Nominal internal resistance used for test	
	IR	Measured internal resistance	
	OCV	Open charger voltage	
	LCV	Loaded charge voltage	
	WEI	Weighting state during test, Y or N	
	SOT	SOC table used for test	
	SOV	SOC voltage used for test	
	Accuracy		
	Voltage		0.2% ±10 mV
Current		0.2% ±10 mA	
Resistance (IR)		5% ±1 mΩ	

Range		
Open voltage	5.5 V to 30 V	
6 Volts	Battery test	5.5 V to 6.8 V
	Charge circuit test	5.5 V to 8.5 V
12 Volts	Battery test	8 V to 14 V
	Charge circuit test	8 V to 17 V
24 Volts	Battery test	N/A
	Charge circuit test	16 V to 28 V
Current	1 A to 10 A	
Resistance (IR)	1 mΩ to 100 mΩ	
Setting		
Voltage (record mode)	6 V, 12 V	
Ah (record mode)	1 Ah – 100 Ah in 1 A steps	
Current (load test mode)	0.5 A to 10 A in 0.5 A steps	
Time (load test mode)	0.5 sec to 5 sec in 0.5 sec steps	
Nominal Internal Resistance (NIR)	N/A, 0.1 mΩ to 199 mΩ	
Temperature (record mode)	User settable	
Real Time Clock	√	
Data Time Log	√	
Cycle Time	≤ 5 seconds, typical	
Battery Load current	0.1 C based on Ah value entered by user	
SOC tables	2 default tables, one for 6 and one for 12 V	
	3 user configurable tables for 6 V	
	3 user configurable tables for 12 V	
Battery Charger Circuit Test 6, 12 or 24 Volt Charger Circuits	Quick Test mode	Measurement data is displayed but not recorded
	Record mode	Records open and loaded charger circuit voltage
Pass / Fail	Optional, calculated based on user provided NIR	
General		
Internal Memory	50 records	
Minimum Operating Voltage	5.5 V	
Minimum Operating Current	0.45 A with back light on, typical	
Display	20 x 4 LCD with back light	
Remote Communication	USB Cable (type B)	
Test Leads Type	Detachable	
Storage Temperature	-10° C to 70° C	
Dimensions (W x H x D)	2.91" x 10.44" x 2.28" (74 x 265.1 x 58 mm)	
Weight	2.65 lbs (1.2 kg)	
Warranty	One year	
Included Accessories	USB (type B) cable, two sets alligator test leads, adapter for testing charger circuit, test report, certificate, user manual available for download.	

8 Service Information

Warranty Service: Please go to the support and service section on our website at www.bkprecision.com to obtain a RMA #. Return the product in the original packaging with proof of purchase to the address below. Clearly state on the RMA the performance problem and return any leads, probes, connectors and accessories that you are using with the device.

Non-Warranty Service: Please go to the support and service section on our website at www.bkprecision.com to obtain a RMA #. Return the product in the original packaging to the address below. Clearly state on the RMA the performance problem and return any leads, probes, connectors and accessories that you are using with the device. Customers not on an open account must include payment in the form of a money order or credit card. For the most current repair charges please refer to the service and support section on our website.

Return all merchandise to B&K Precision Corp. with prepaid shipping. The flat-rate repair charge for Non-Warranty Service does not include return shipping. Return shipping to locations in North America is included for Warranty Service. For overnight shipments and non-North American shipping fees please contact B&K Precision Corp.

B&K Precision Corp.
22820 Savi Ranch Parkway
Yorba Linda, CA 92887
www.bkprecision.com
714-921-9095

Include with the returned instrument your complete return shipping address, contact name, phone number and description of problem.

9 Limited One-Year Warranty

B&K Precision Corp. warrants to the original purchaser that its products and the component parts thereof, will be free from defects in workmanship and materials for a period of **one year** from date of purchase.

B&K Precision Corp. will, without charge, repair or replace, at its option, defective product or component parts. Returned product must be accompanied by proof of the purchase date in the form of a sales receipt.

To help us better serve you, please complete the warranty registration for your new instrument via our website www.bkprecision.com

Exclusions: This warranty does not apply in the event of misuse or abuse of the product or as a result of unauthorized alterations or repairs. The warranty is void if the serial number is altered, defaced or removed.

B&K Precision Corp. shall not be liable for any consequential damages, including without limitation damages resulting from loss of use. Some states do not allow limitations of incidental or consequential damages. So the above limitation or exclusion may not apply to you.

This warranty gives you specific rights and you may have other rights, which vary from state-to-state.

B&K Precision Corp.
22820 Savi Ranch Parkway
Yorba Linda, CA 92887
www.bkprecision.com
714-921-9095

10 CE Declaration of Conformity

This instrument meets the requirements of 2006/95/EC Low Voltage Directive and 2004/108/EC Electromagnetic Compatibility Directive with the following standards.

Low Voltage Directive

- EN61010-1 : 2001

EMC Directive

- EN61326-1 : 2013
- CISPR11
- EN61000-4-2 : 2009
- EN61000-4-3 : 2006 + A2 : 2010
- EN61000-4-8 : 2010

Reference to our most updated CE info: <http://www.bkprecision.com/support/downloads/ce-declarations.html>

B&K Precision Corporation
22820 Savi Ranch Parkway
Yorba Linda, California 92887
www.bkprecision.com

2018 B&K Precision Corporation

rev080918