

BK PRECISION®

Model 830C, 890C

Dual Display Capacitance Meter

INSTRUCTION MANUAL



Safety Summary

The following safety precautions apply to both operating and maintenance personnel and must be observed during all phases of operation, service, and repair of this instrument.

DO NOT OPERATE IN AN EXPLOSIVE ATMOSPHERE

Do not operate the instrument in the presence of flammable gases or fumes. Operation of any electrical instrument in such an environment constitutes a definite safety hazard.

KEEP AWAY FROM LIVE CIRCUITS

Instrument covers must not be removed by operating personnel. Component replacement and internal adjustments must be made by qualified maintenance personnel.

DO NOT SUBSTITUTE PARTS OR MODIFY THE INSTRUMENT

Do not install substitute parts or perform any unauthorized modifications to this instrument. Return the instrument to B&K Precision for

service and repair to ensure that safety features are maintained.

WARNINGS AND CAUTIONS

WARNING and **CAUTION** statements, such as the following examples, denote a hazard and appear throughout this manual. Follow all instructions contained in these statements.

A **WARNING** statement calls attention to an operating procedure, practice, or condition, which, if not followed correctly, could result in injury or death to personnel.

A **CAUTION** statement calls attention to an operating procedure, practice, or condition, which, if not followed correctly, could result in damage to or destruction of part or all of the product.

SAFETY GUIDELINES

To ensure that you use this device safely, follow the safety guidelines listed below:

- This meter is for indoor use, altitude up to 2,000 m.
- The warnings and precautions should be read and well understood before the instrument is used.
- When measuring in-circuit components, first de-energize the circuits before connecting to the test leads.
- Never attempt to measure voltage with this instrument.
- Do not use the device if it appears damaged in form.
- Inspect the leads for damaged insulation or exposed metal. Replace damaged leads if necessary.
- Disconnect power and discharge all capacitors prior to testing.
- The meter is safety-certified in compliance with EN61010 (IEC 1010-1) Installation

Category II (CAT. II) 50 V, Pollution Degree 2 environment.

- Use the meter only as specified in this manual. Otherwise, the protection provided by the meter may be impaired.
- The power for the meter is supplied with a single standard 9V battery. It can also operate from AC line using a 12V AC to DC adaptor. If a power adaptor is selected, please be sure to use one with correct AC line input voltage and fulfills the safety requirements of a relevant IEC standard.
- Use only battery specified by the meter. See “*Installing Battery*” section for details.

Safety Symbols



This symbol is a warning and indicates that the user should refer to the operating instructions located in the manual.



DC Current



Indicates inside pin is positive (+), outside is negative (-)

Compliance Statements

**Disposal of Old Electrical & Electronic Equipment
(Applicable in the European
Union and other European countries with separate
collection systems)**



This product is subject to Directive 2002/96/EC of the European Parliament and the Council of the European Union on waste electrical and electronic equipment (WEEE) , and in jurisdictions adopting that Directive, is marked as being put on the market after August 13, 2005, and should not be disposed of as unsorted municipal waste. Please utilize your local WEEE collection facilities in the disposition of this product and otherwise observe all applicable requirements.

Environmental Conditions

Operating Environment	0 °C to 40 °C
Storage Humidity	0 – 80% R.H.
Storage Environment	-20 °C to +50 °C
Pollution degree	Pollution degree 2

TABLE OF CONTENTS

SAFETY GUIDELINES	3
INTRODUCTION	11
PACKAGE CONTENTS	13
FRONT PANEL OVERVIEW	14
Front Panel Display Descriptions.....	15
Front Panel Buttons	16
LCD DISPLAY OVERVIEW	18
LCD Display Descriptions	18
PUSH BUTTONS OVERVIEW	20
POWERING INSTRUMENT	22
Installing Battery	22
Connecting External Power Source	24
Low Battery Indication	27
Backlit Display	27
POWER ON OPTIONS	29
Reset HI/LO Limits.....	29
View Firmware Version.....	30
Setup Menu	30
SETUP OPTIONS	31

Baud Rate (bAUd)	33
Parity (PArT)	35
Data Bits (Data)	36
Echo (ECHO).....	37
Print Only (Prnt)	38
Key Beeper (bEEP)	39
Lock Buttons (LbUt).....	40
Auto Power Off (AOFF).....	41
Backlit Display Time (bLIt)	44
Bright Level Off State (bOFF)	44
Brightness Level On State (bON)	47
Reset to Default (dEFA).....	49
OPERATION INSTRUCTIONS.....	51
Data Hold/Trigger Hold	51
Static Recording	53
Relative Mode.....	57
Tolerance.....	60
Compare Mode	65
REMOTE COMMUNICATION	75
Connecting Instrument to PC.....	75
USB (Virtual COM) Configuration	76

Remote Mode	76
Command Protocols	77
MEASUREMENT TIPS	99
SUPPLEMENTAL INFORMATION	101
Guard Terminal.....	101
SPECIFICATIONS	102
General specification	103
Electrical specifications.....	105
MAINTENANCE.....	106
Service.....	106
Troubleshoot Tips	106
Cleanin.....	107
SERVICE INFORMATION	109
LIMITED WARRANTY	110
INDEX	111

INTRODUCTION

B&K Precision's 830C and 890C 11,000-count hand-held capacitance meters measure capacitance and include a capacitance sorting function. Simple to operate, the instruments can make quick measurements and simplify the capacitance sorting process.

Capacitance is measured by using a small DC voltage signal that slightly charges the connected capacitor for a short time. Unlike other handheld instruments such as LCR meters, it does not use an AC signal with a specific test frequency to make measurements.

Front panel push buttons maximize the convenience of function and feature selection. The meters support the following modes: Tolerance sorting mode, relative mode, data hold, manual and auto range mode, min/max/avg recording, and high/low limit setting.

Test data can be transferred to a PC through a Mini USB connection, which is useful for data logging applications.

A tilt stand provides position flexibility for viewing and operating the meter. The over-molding rubber case

protects the meter for better durability. Additionally, the top rubber visor molding above the screen is designed to prevent scratches on the display when the meter is positioned upside down.

A single 9V battery or the included DC 12V power adaptor (included with model 830C only) can be used to power the meter. This gives user flexibility for portable or bench-top use.

PACKAGE CONTENTS

Each 830C and 890C capacitance meters are shipped with the following contents.

- 830C or 890C capacitance meter
- Instruction Manual
- Mini USB Interface Cable
- Red & Black Banana to Alligator Test Leads
- 9V Battery
- *AC Adapter (model 830C only)

**This can be purchased as an optional accessory for model 890C. There are two versions of this adapter available. One version is for 110 V AC line voltage input, and the other for 220 V AC line voltage input.*

Please locate each item from the original packaging and contact B&K Precision immediately if something is missing.

FRONT PANEL OVERVIEW

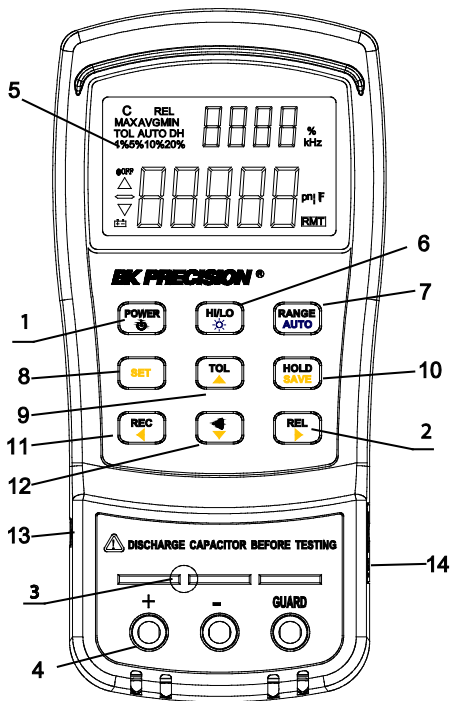

Figure 1 - Front Panel Display (model 830C shown)

Front Panel Display Descriptions

1. Power ON/OFF Button
2. Relative mode / right arrow selection button
3. Input sleeve terminals for positive (+), negative (-), and guard (see “Guard Terminal” in “SUPPLEMENTAL INFORMATION” section for details)
4. Input sockets (banana jack inputs)
5. LCD Display
6. Set HI/LO limit / Back light button
7. Manual and Auto range button
8. Set button for entering HI/LO limit set function menu
9. Tolerance mode / up arrow selection button
10. Data Hold / Save HI/LO limit settings button
11. Record mode selection button
12. Compare mode button
13. Standard mini USB port (for remote controllability)
14. 12V DC adapter input (use with an external power adapter (rated 12VDC, 150mA, 4mm power plug))

Note: Use with included power adapter only. Use with improper power adapters may damage instrument.

WARNING: Before connecting an external power adapter, please check the battery compartment in the rear side of the unit. If a battery is installed, be sure that the polarity matches the (+) and (-) labels as indicated inside the battery compartment. If it is not installed correctly, please remove the battery and install it with correct matching polarity as indicated in the compartment. See “Installing Battery” section for details. DO NOT, at any time, connect an external power adapter when a battery is installed incorrectly. Doing so will damage the instrument and void its warranty.

Front Panel Buttons

All front panel buttons have specific colored labels on them. They are all marked in white, blue, or yellow color. Each color has a specific representation, as described below:

White – With the exception of the  button, all white colored labels represent the primary function of that

button; meaning that function will be set or configured upon pressing it. To escape out of the functions, hold and press the corresponding button for two seconds.

Blue – Some of the buttons have a blue label underneath a white label. This means the function indicated by the blue label will be set if that button is pressed and held for **2 seconds**.

Yellow – There are total of 6 buttons with

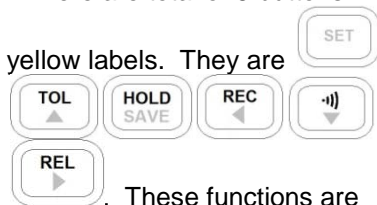

. These functions are exclusively for use when entering the **SET** menu for configuring setup menu items as well as compare function. See “Setup Menu” and “Compare Mode” sections respectively for details.

LCD DISPLAY OVERVIEW

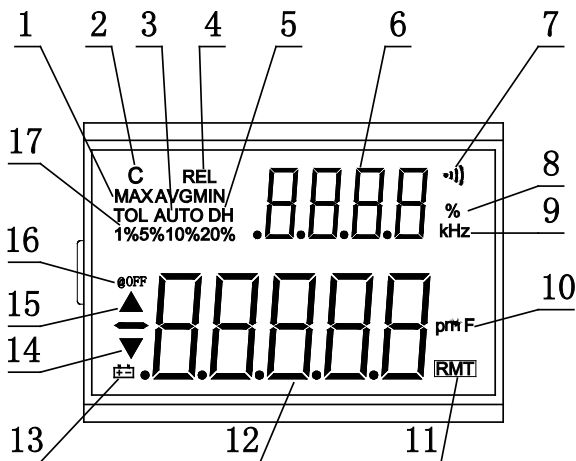









Figure 2 - LCD Indicator Display

LCD Display Descriptions

1. MAX AVG MIN – Static Recording mode, indicates present reading
2. C – Reading indicator
3. AUTO – Auto range
4. REL – Relative mode indicator
5. DH – Data Hold
6. 0.0.0.0 – Secondary display

7.  – Beep tone indicator for tolerance and compare mode
8. % - Tolerance percentage indicator
9. kHz – Frequency units indicator
10.  – Capacitance units (Farad) indicator
(Actual display will show pF, mF, or μ F)
11.  – Remote mode indicator
12.  – Primary display
13.  – Low battery indicator
14.  – Reading out of the LO limit
15.  – Reading out of the HI limit
16. @OFF – Enable Auto Power off indicator
17. TOL 1%5%10%20% - Tolerance mode percentage for sorting capacitance

PUSH BUTTONS OVERVIEW

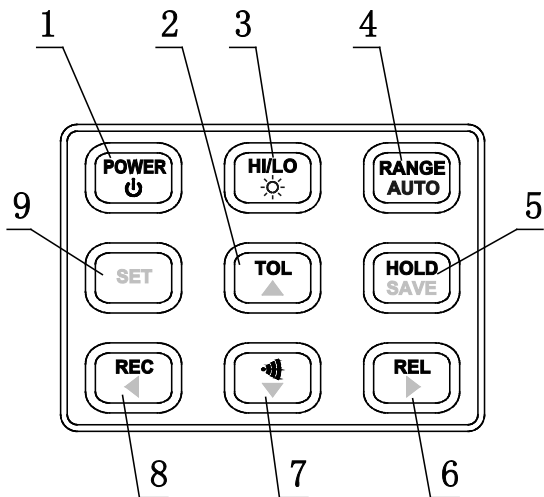

Figure 3 - Front Panel Buttons

1. Power ON or OFF
2. Tolerance Mode
3. HI/LO Limits for compare mode and to enable backlight
4. Auto or Manual range

5. Data hold and save setting for compare mode
6. Relative mode and right arrow key
7. Compare mode and down arrow key
8. Record mode and left arrow key
9. Set HI/LO limits for compare mode

POWERING INSTRUMENT

Before operating the instrument, make sure to connect it to a power source, which could be either a battery or an external AC adapter.

Installing Battery

The 830C and 890C capacitance meters can be powered by a battery, thus making it portable.

The meters use a standard 9V size battery (or NEDA 1604, JIS006P, IEC6F22 carbon-zinc or alkaline battery).

To install the battery:

1. Place the meter upside down. Open up the back-flip stand, and locate the screw that tightens the battery compartment cover as indicated in Figure 4. Use a screwdriver to unscrew and remove the cover.



Figure 4 - Back Cover

2. Insert 9V battery into compartment. Note the positive (+) and negative (-) terminals as indicated inside the battery compartment (See Figure 5). Be sure to insert the battery with matching polarity.

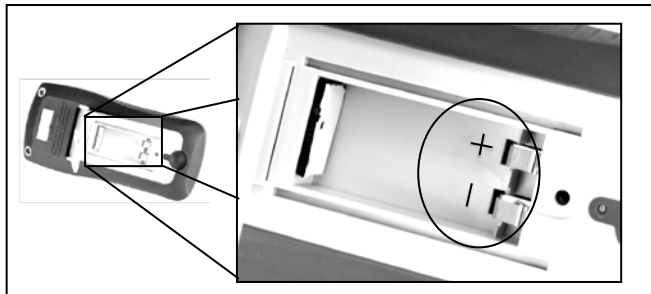



Figure 5 - Battery Compartment

3. Place the battery compartment cover piece by sliding it into the top slid first. Place screw at the bottom of the cover piece and tighten down with a screw driver.
4. Push and hold down the  button for 2 seconds to turn on the instrument.

Connecting External Power Source

The 830C and 890C can also be powered using an external AC adapter. The model 830C comes with this adapter included in the package, while it is optional for model 890C. There are two types available. One with 110 V AC line voltage input, and one with 220 V AC line voltage input. Be sure to use

one that has the correct AC line voltage input for use in your country.

For external power, use AC adapter rated for output 12VDC, 150mA, with a standard 4mm connector only.

WARNING: Use of incorrect adapters may damage the instrument. Please use B&K Precision's adapter only. Be sure to use one with the correct AC line input voltage.

To connect the adapter, do the following:

1. If a battery is installed, please check the battery compartment again that the polarity of the battery matches the polarity as indicated by the labels inside the compartment. If it is not, please remove and insert the battery with matching polarity. If a battery is not installed, continue to the next step.

WARNING: DO NOT, at any time, connect an external power adapter when a battery is installed incorrectly (reverse polarity or non-matching polarity to indicator of battery compartment). Doing so will damage the instrument and void its warranty.

2. Connect the AC adapter connector into the right side panel of the instrument. See Figure 6 below.
3. Now, connect the AC Adapter socket into an electrical outlet.
4. Push and hold down the  button for 2 seconds to turn on the instrument.

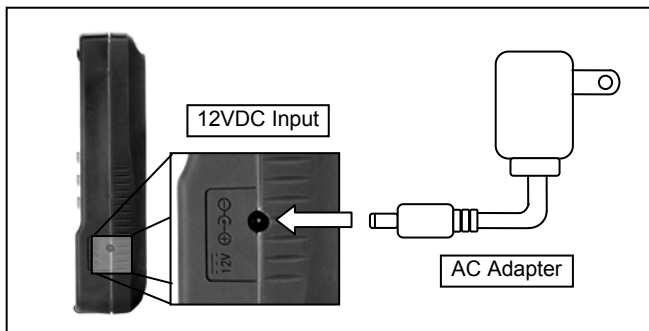



Figure 6 - Connecting AC Adapter to Meter

Note: *The meter can be operated with a battery installed while an AC adapter is plugged in at the same time (As long as the battery is inserted properly with correct polarity). In this event, the meter will automatically switch to consume power from the AC adapter instead of the battery to preserve battery life.*

Low Battery Indication

The capacitance meter has a low battery indicator to notify the user when to replace the battery. When the display starts flashing the  indicator, the battery voltage is below normal working voltage. In this case, accuracy of the meter will also decrease. It is recommended that the battery be replaced as soon as possible before continuing operation. See “Installing Battery” for instructions.

Backlit Display

The capacitance meter has a backlit display that allows you to see the LCD display in dark conditions.

To turn **on** the back light, press and hold the  button for 2 seconds. Back light will turn on and brighten the LCD display.

To turn **off** the back light at any time, press and hold the  button for 2 seconds again. Back light will turn off and return to normal display.

When Using Battery Power

When the meter is powered using 9V battery, the back

light display will turn on upon holding the  button for 2 seconds. It will stay at maximum brightness for 15 seconds if backlight settings are set to default value.

When Using External Power

When the meter is powered using an external AC adapter, the back light display will turn on upon

pressing and holding the  button for 2 seconds. It will stay at maximum brightness continuously until

the user presses and holds the  button for 2 seconds again.

Note: *If a battery is installed while using an AC adapter simultaneously, unplugging the AC adapter will automatically start the back light timer configured under “SETUP OPTIONS” and back light will turn off once the time is up.*

POWER ON OPTIONS

To select power on options, press and hold the pushbutton as indicated in the table below while turning on the meter. For example, press and hold



and press



to enter setup menu.

PUSHBUTTON	DESCRIPTION
•••)	Reset the high and the low limits to factory default values.
REL	To see firmware version
SET	Setup menu for configuration settings of the meter.

Reset HI/LO Limits

To reset the high and low limit values to factory

default values, press and hold the



and press



button. Keep holding the



button for



five or more seconds or until you hear two audible beeps. Now, release and all HI and LO limit values are reset back to factory default values.



Note: If you released the  button before hearing the two beeps, the display will not show any digits on the primary display for a few more seconds. Please wait until it displays digits before operation.

View Firmware Version

To check the firmware version of the meter, press and

hold  and press the  button. Keep

holding the  button for two seconds and release. The screen will now show the version. At this point, the power button is disabled. In order to resume normal operation, press any other button except the power button and it will go into normal display.

Setup Menu

To enter the setup menu of the meter, press and hold

the  and press the  button. Keep



holding  until “bAUd” is displayed on the primary display. For details on configuring settings, please see SETUP OPTIONS section. To exit setup



menu, press and hold  for 2 seconds and the meter will return to normal display.

SETUP OPTIONS

There are various system parameters that the meter can be configured for when entering the setup menu (see “Setup Menu” section for instructions on how to access the menu). The below table lists these parameters, as well as their factory default settings and selectable parameters.

Table 1 - Setup Menu System Settings and Default

Menu item	Factory Setting	Selectable Parameters
bAUd	9600	Baud rate: 2400, 4800, 9600, 19200
PArT	NONE	Parity: odd, even, none
Data	8-b	Data bits: 8 bits or 7 bits (Stop bit

		is always 1 bit)
ECHO	OFF	Echo: "ON" or "OFF"
Prnt	OFF	Print: "ON" or "OFF"
beep	ON	Beep: "ON" or "OFF"
LbUt	OFF	Lock buttons , "OFF": enable push buttons "ON": disable pushbuttons
AOFFF	15	1~99 minutes, "OFF" means to disable auto power off.
bLIlt	15	1~99 seconds, "OFF" means to disable turning off backlit automatically.
bOFFF	01	Bright level of backlit at OFF state: OFF~03
bON	03	Bright level of backlit at ON state: OFF~03
dEFA	rSt	Reset all above items to factory default settings

NOTE: After changing any or all setting options

within the setup menu, press and hold  button for two seconds or until a beep is sound to save settings. The meter will **NOT** store the changed settings if this is not done upon exiting the setup menu.

Baud Rate (bAUd)

The baud rate is used for communication with a PC over the USB interface. For PC communication, the baudrate **MUST** match the settings on the PC side.

Selectable rates are (in units of bps):

2400, 4800, 9600, 19200

Note: The secondary display of the meter will show the rates with units as “kHz”, but it’s actually a reference for multiple of 1000 or “x 10³”. For example, 9.6 kHz means $9.6 \times 10^3 = 9600$.

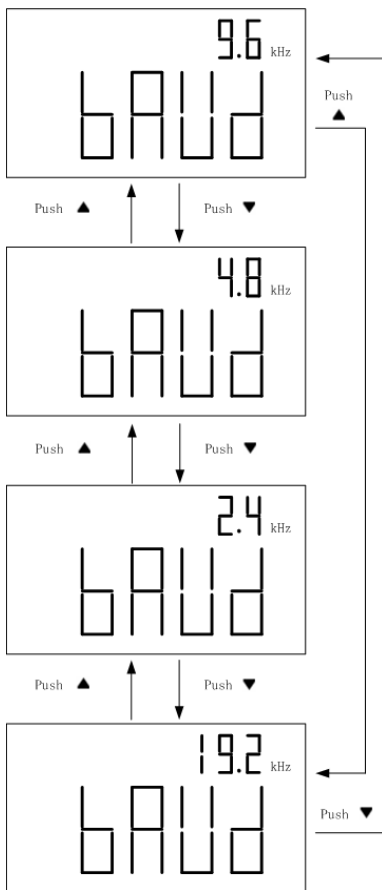

Figure 7 - Steps to Change Baud Rates

Parity (PArT)

The parity setting is used for communication with the PC over USB interface. For PC communication, parity **MUST** match the settings on the PC side.

Selectable parameters are:
None, Even, Odd

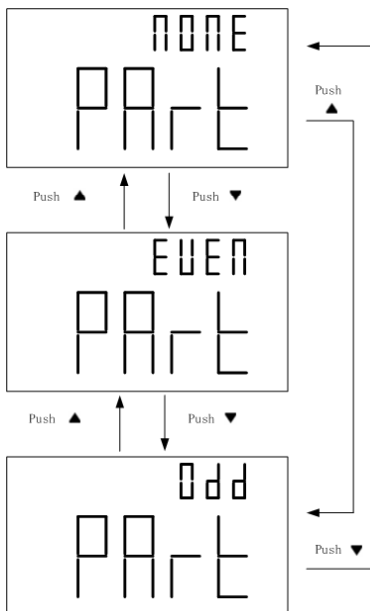

Figure 8 - Steps to Change Parity

Data Bits (Data)

The data bits setting is used for communication with a PC over USB interface. For PC communication, data bits **MUST** match settings on the PC side.

Selectable parameters are (in units of bits):
8, 7

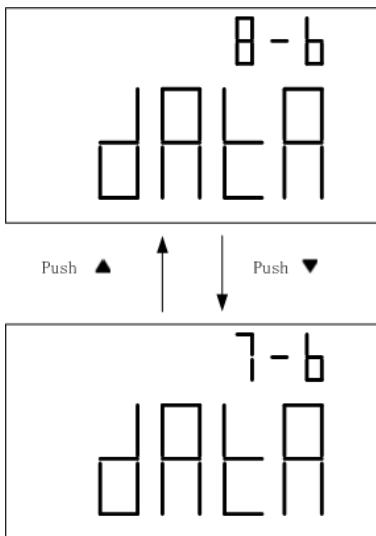

Figure 9 - Steps to Change Data Bits

Echo (ECHO)

The echo function will set the meter to “echo” or return all characters that are received. For example, if “*IDN?” is sent to the meter, it will return “*IDN?” as well as the queried information.

Selectable parameters:

OFF, ON

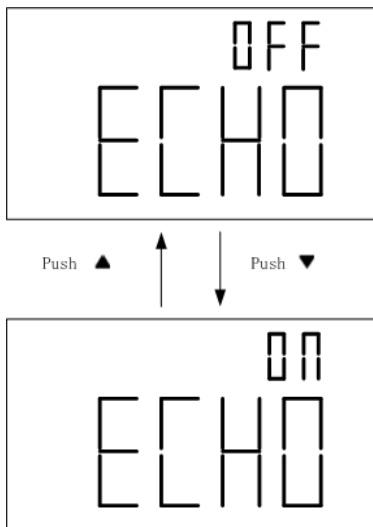

Figure 10 - Steps to toggle Echo Settings

Print Only (Prnt)

Under remote operation, when the meter is set with print only mode to “ON”, it will print out measured data when the measurement cycle is complete and automatically send the newest data to the PC continuously. In this mode, any commands sent from the PC will not be accepted. The remote indicator on the meter display will flash when this mode is enabled.

Selectable parameters:

OFF, ON

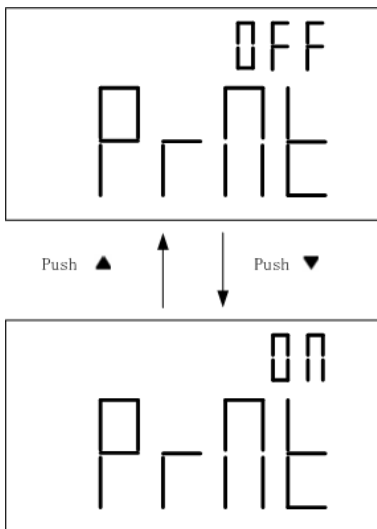

Figure 11 - Steps to Change Print-Only Setting

Key Beeper (bEEP)

The key press beep sound can be enabled or disabled.

Selectable parameters:

ON, OFF

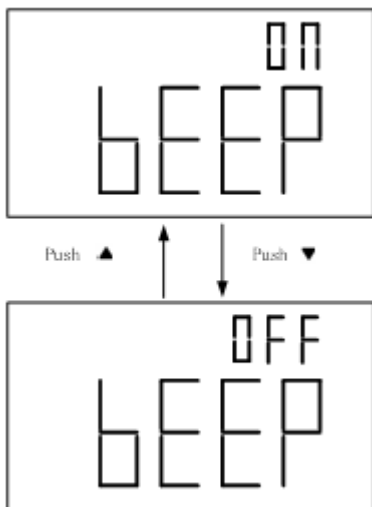

Figure 12 - Steps to Toggle Key Keep

Lock Buttons (LbUt)

The front push buttons can be locked by changing the settings of this option. When “ON”, buttons will be locked and cannot be pressed upon turning on the meter. All buttons are disabled at this point except the



button, which can be used to turn off the meter. The power-on option can still be operated even if buttons are locked. This will provide users

with a means to disable or unlock the buttons when necessary.

Selectable parameters:

OFF, ON

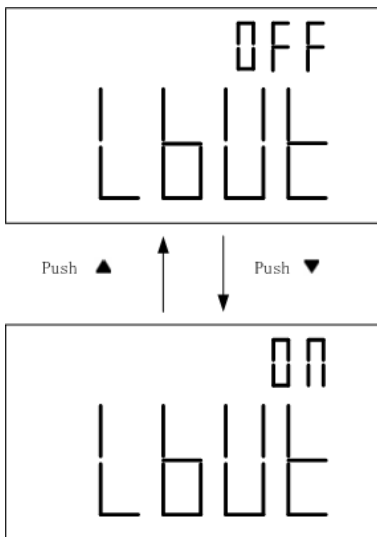

Figure 13 - Steps to Change Lock Buttons Settings

Auto Power Off (AOFF)

This option will allow a timer to be set for auto power off. When enabled, the display will have “@OFF”

indicator. When disabled, the meter will run indefinitely.

Note: The timer will not be in effect if any of the below happens:

1. Push buttons are used.
2. Static recording is set.
3. Auto power off is disabled or "OFF".

If any of the above conditions do not apply, the timer will start counting based on the timer setting configured.

Selectable parameters:

OFF, 1 – 99 minutes

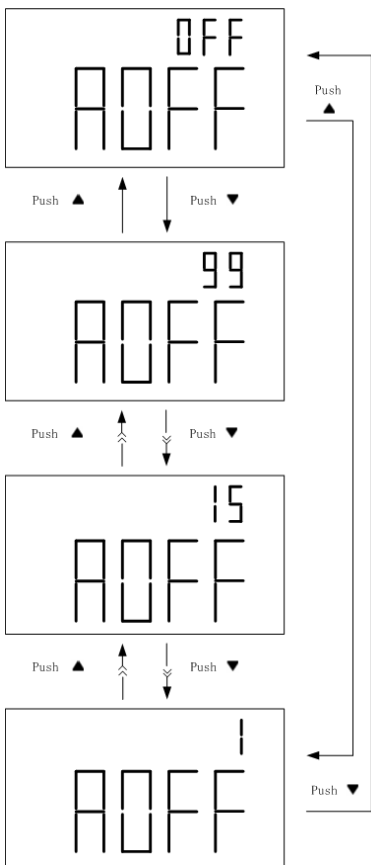

Figure 14 - Steps to Change Auto Power Off Settings

Backlit Display Time (bLit)

Back light of the meters can be turned off automatically with a timer. Once set, back light will remain on for the period of the timer setting upon enabling the back light by pressing and holding



for two seconds. If it is set to “OFF”, the back light will remain ON indefinitely.

Selectable parameters:

OFF, 1 – 99 seconds

Note: To conserve and extend battery life, select a shorter timer setting.

Bright Level Off State (bOFF)

This option allows users to set the brightness level for the “off state” of the back light. The “off state” refers to the state after backlight is enabled and backlight timer (bLit) ends. For example, this option is used when users want backlight to be enabled for a period of time (set by bLit) and then dim the brightness indefinitely afterwards. When set to “OFF”, back light will be off in the off state. If a level is set, the backlight will be on with the selected brightness level after backlight is enabled and backlight timer ends.

Selectable parameters,
OFF, 01, 02, 03

Note: “**03**” is the brightest and “**01**” is the dimmest.

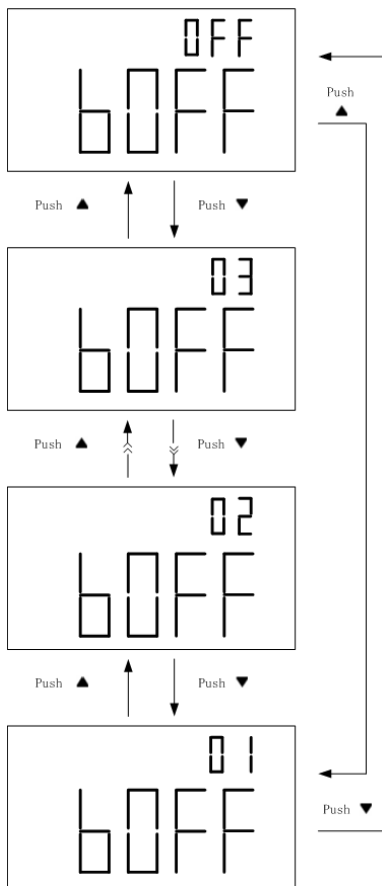

Figure 15 - Steps to Change Back light Off State

Brightness Level On State (bON)

This option allows user to set the brightness level for the on state of the back light. When it is set to “OFF”, back light will be in the lowest brightness level in the on state. If a level is set, the backlight will be much brighter when backlight is enabled by pressing the



button.

Selectable parameters,

OFF, 01, 02, 03

Note: “03” is the brightest and “01” is the dimmest level. However, when set, “OFF” state will still be the lowest brightness level.

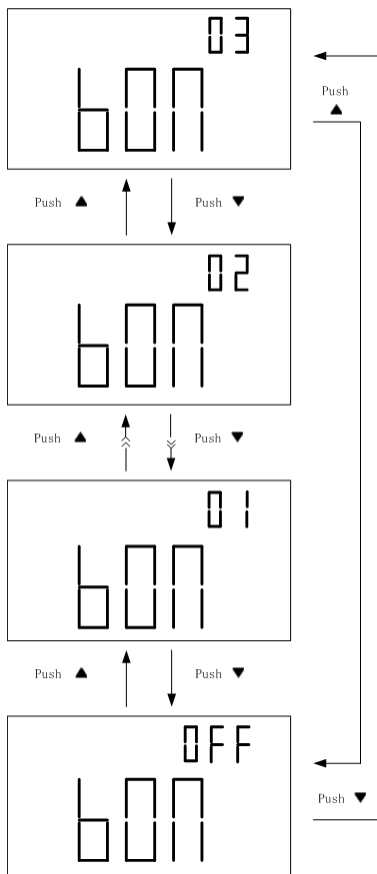

Figure 16 - Steps to Change Back light ON State

Reset to Default (dEFA)

This option will reset all setup option parameters back to default values as listed in Table 1 - Setup Menu System Settings and Default. To reset, simply press



and hold the button for two seconds. The meter will then be resetting all parameters immediately. All push buttons will not respond immediately, so wait for approximately 5 seconds until the display changes and returns to “bAUd” option. Once this is displayed, users can verify that all settings under setup menu are set to factory default.

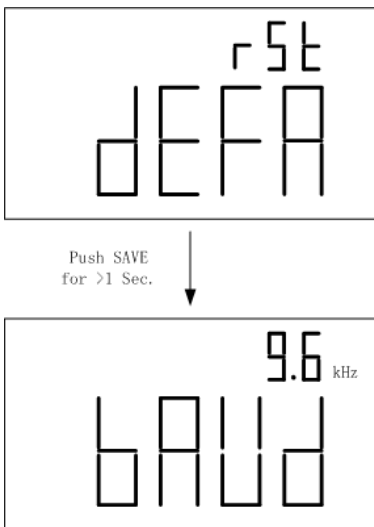



Figure 17 - Reset to Factory Default

OPERATION INSTRUCTIONS

Data Hold/Trigger Hold

The data hold/trigger hold function allows the user to freeze the display when pressed, holding the measured value until data hold is turned off.

Turn On Data Hold

To use data hold, press the  button once. The “DH” indicator will display on the screen when data hold is active.

Trigger Hold

Users can send a trigger hold once data hold has been turned on. While “DH” indicator is displayed, all subsequent key press of the  button will send a trigger to acquire a reading and hold immediately.

Turn Off Data Hold

To disable the data hold, press and hold  button for two seconds. The “DH” indicator will disappear on the screen, and meter will turn to normal operation mode.

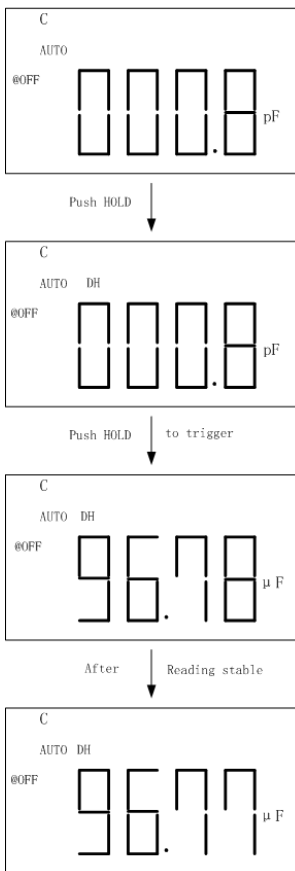



Figure 18 - Data/Trigger Hold Operation

Static Recording

This mode is used for recording maximum, minimum, and average capacitance values. It captures only stable values and updates to memory. Values that result in displaying “OL” or that are below 10 counts are not recorded. This mode is useful for determining the range of values a component falls into.



Enable Static Recording

Press the  button to enter the static recording mode. The display should indicate “**MAX AVG MIN**” simultaneously. This indicates the meter is in static recording mode and recording is performed immediately.

Note: In static recording mode, the auto power off function will be disabled and the “@OFF” indicator will be turned off automatically. It will be re-enabled with its previous settings once meter exits static recording mode.

Using Static Recording

There are four different modes that can be selected in static recording. These modes can be changed with

each  button press. With each press of the  button, the modes will cycle through as followed: :

Recording Mode → Maximum Mode → Minimum Mode → Average Mode

Recording Mode

This is the default mode when first enabling static recording. In this mode, the “**MAX AVG MIN**” indicator will be displayed. At this point, the meter will start recording measured values applied to the input sockets or terminals. During the recording process, maximum, minimum, and average values will be stored. A beep will sound once a recording has been stored.

***Note:** Subsequent beep tones may occur in this mode if there are new values that are recorded. For example, if a new maximum is detected, it will beep once again to indicate that the new value has been stored. Any previously stored values will be overwritten with the new recorded values.*

Maximum Mode

In this mode, the “**MAX**” indicator will be shown on display. This indicates that the value in the primary display represents the recorded maximum value.

Minimum Mode

In this mode, the “**MIN**” indicator will be displayed. This indicates that the value in the primary display represents the recorded minimum value.

Average Mode

In this mode, the “**AVG**” indicator will be displayed. This indicates that the value in the primary display represents the recorded average value. This average value is obtained by taking the maximum and minimum recorded values and taking the average of the two values.

Disable Static Recording



To exit this mode, press and hold the  button for two seconds. The “**MAX AVG MIN**”, “**MAX**”, “**MIN**”, or “**AVG**” indicator will disappear on screen, and auto power off will be re-enabled again if it was enabled prior to entering static recording mode. “**@OFF**” indicator will come back on when enabled.

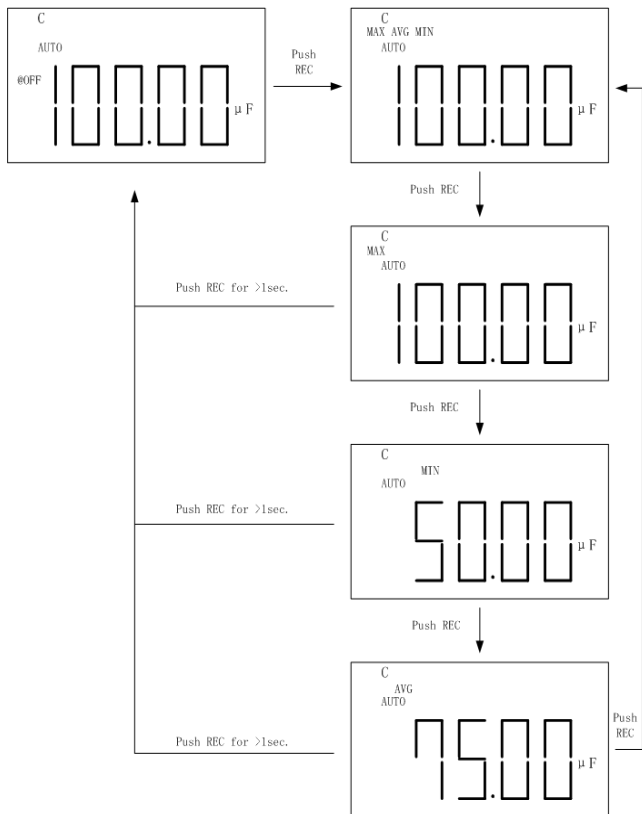



Figure 19 - Steps to Use Static Recording

Relative Mode

Relative mode is used when the user wants to “zero” the meter based on a reference value or wants to obtain a reading that is relative to a reference value. For example, if test leads are used in the measurement, the user may want to set a reference with the test leads inserted into the input terminals so that any measurements taken will not take into account the test leads.

Setup Relative Mode

To setup the relative mode, simply press the  button once. The value that is on the display will immediately be stored as the “reference” value. This reference value will be used for all measurements so as long as the meter is in relative mode, which is indicated by the “**REL**” indicator on the display.

A common use of relative mode is to “zero” out the meter. With nothing connected to the input sockets

and terminals, simply press the  button once and the meter will “zero” out, meaning all display readings will be set to 0.

To make measurements within a specific test setup or with test leads, it is recommended that the user first

have test leads or wires connected to the meter in the

fashion that they desire. Then, press the  button once to “zero” out the meter as reference. This way, any measurements taken would not be affected by the test leads or setup.

Note: Relative mode can be set in both auto and manual range, but cannot be set when “**OL**”, or overload is displayed on the meter.

Disable Relative mode

To disable relative mode, simply press and hold the

 button for two seconds. The “**REL**” indicator will disappear, which indicates the relative mode is disabled.

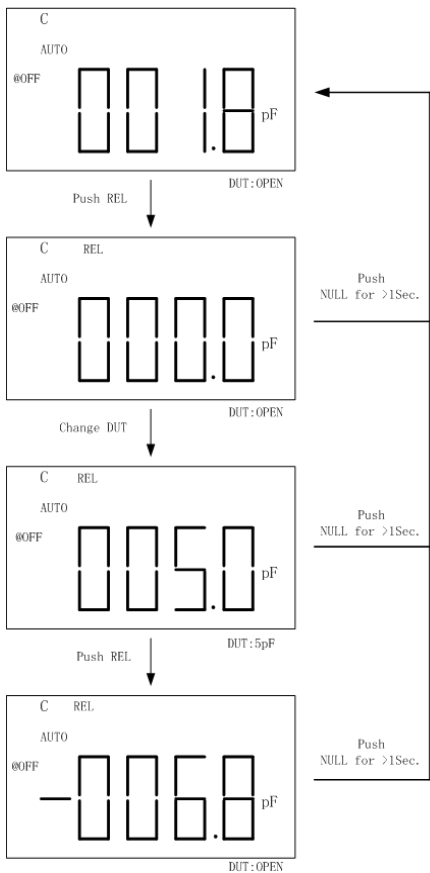

Figure 20 - Steps to Use Relative Mode

Tolerance

The tolerance mode feature is specifically used for component sorting purposes. Users who need to test and sort through a large number of components will find this function quite helpful.

Tolerance Range

The tolerance function is configured primarily by percentage range, meaning a percentage is used to define whether a measured value is within tolerance or out of tolerance.

Selectable tolerance range is: **1%**, **5%**, **10%**, and **20%**.

Setup Tolerance

1. Insert the component to be used as the “standard” reference value. In other words, insert a known “good” component that will be used for testing against all other components.

(See Figure 21 for illustration)

Note: *The tolerance mode cannot be activated unless the meter senses that a*

capacitance is connected to either the input sockets or terminals.

WARNING: Be sure that the capacitor is fully discharged BEFORE inserting it into the input sockets or terminals. For large capacitors, it may take longer periods of time for a full discharge. Inserting a charged or partially charged capacitor into the meter's input sockets or terminals may produce an electric hazard and may also damage the instrument, thus rendering it unusable.

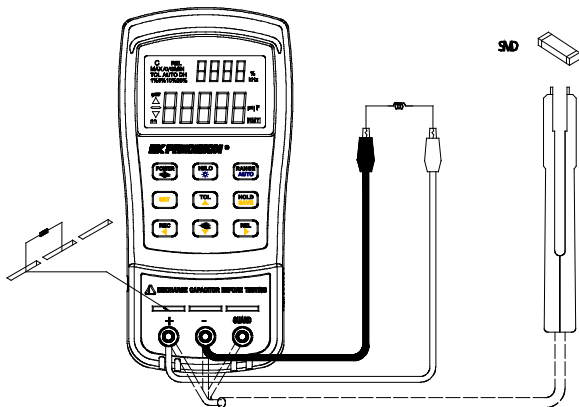

Figure 21 - Inserting Capacitance to Inputs

2. Once the desired measured reading is



displayed, press the button once to store the reading as the “standard” value or test reference value. At this point, the “**TOL**” will be displayed on the screen, indicating that the tolerance mode is activated.

3. To select the tolerance range, press the



- button once more. For each button press, the meter will cycle through the tolerance range percentage in this order: **1%**, **5%**, **10%**, **20%**. These percentage ranges will also be indicated on the LCD display by the indicators “**1%**”, “**5%**”, “**10%**”, or “**20%**” respectively. The component to be tested will be verified within the selected tolerance % of the “standard” value or test reference value (as configured from step 2).
4. Within a few seconds, an audible tone will be heard.

One single “beep” or tone means the component is within tolerance.

Three “beeps” or tones means the component is out of tolerance.

Note: Under the following instances, the tolerance mode cannot be set:

1. After setting recording mode
2. After setting HI/LO limit for compare mode
3. The display shows “**OL**” for overload.

Disable Tolerance Mode

To disable or exit out of tolerance mode, simply press



and hold down the button for two seconds. The “**TOL**” and/or the percentage indicators “**1%**”, “**5%**”, “**10%**”, or “**20%**” will disappear on the LCD display.

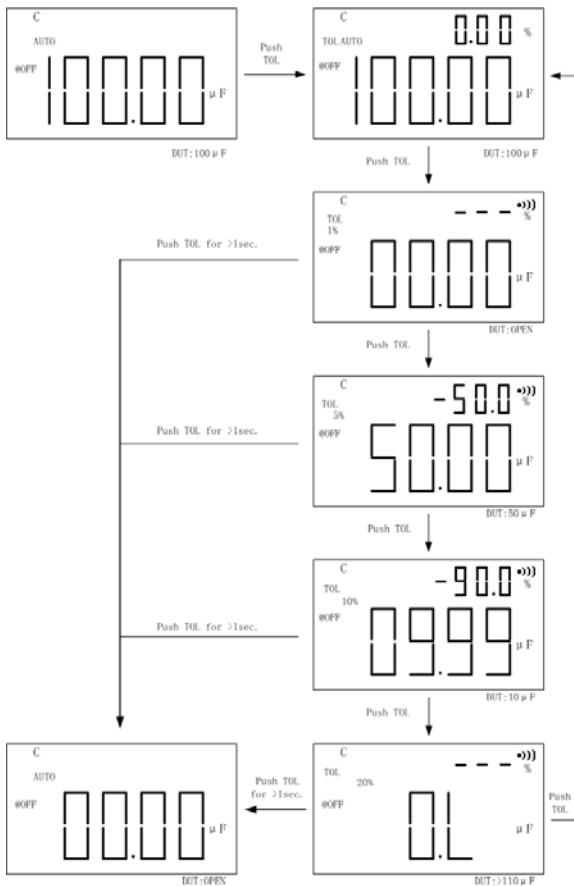

Figure 22 - Steps to Setup Tolerance Mode

Compare Mode

This function allows you to sort capacitors and to configure 25 sets of limit ranges. The meter comes with preconfigured stored values for high and low limits. See table below:

Table 2 - High/Low Limit Default





Comparison Set	High limit	Low Limit
1	100	90
2	120	108
3	150	135
4	180	162
5	220	198
6	270	243
7	330	297
8	390	351
9	470	423
10	560	504
11	680	612
12	820	738
13	1000	900
14	1200	1080
15	1500	1350
16	1800	1620

17	2200	1980
18	2700	2430
19	3300	2970
20	3900	3510
21	4700	4230
22	5600	5040
23	6800	6120
24	8200	7380
25	10000	9000

Setting Compare Mode

The following procedure demonstrates how to set compare mode.

1. Press  button to enter HI/LO audible alert compare mode. The range will be locked in this mode. The meter will display the “•)))” indicator on the upper right. The secondary display will indicate “C01” to “C25” depending on which set was last saved during previous operation. The last two digits indicate the current comparison set of HI/LO limits. The primary display indicates the present measurement.

2. Press the  button to cycle through the sets from “C01” to “C25”.
3. Press the  button to see the HI and LO values used for the comparison. As an example, the display will cycle through set 5 in this order: “**C05**”, “**L05**”, “**H05**”. The values will briefly display for one second and will return to normal compare display. In the example, it would just return to display “**C05**” on the secondary display.
18. If the reading is outside of the HI or LO limits, three audio beeps will sound, and the secondary display will show “**nGO**” for “no go”. There will be an up or down  arrow indicator on the left next to the primary display.  arrow indicates the value is too high and fails the test.  arrow indicates the value is too low and fails the test. If the reading is within the HI or LO limits, one audio beep will sound and the secondary display will show “**GO**”. After three seconds, the meter will return to ready state again.

Exit Compare Mode

To exit compare mode, simply press and hold  for two seconds. The “ •))” indicator will disappear from the upper right corner of the display, indicating that meter is no longer in compare mode.

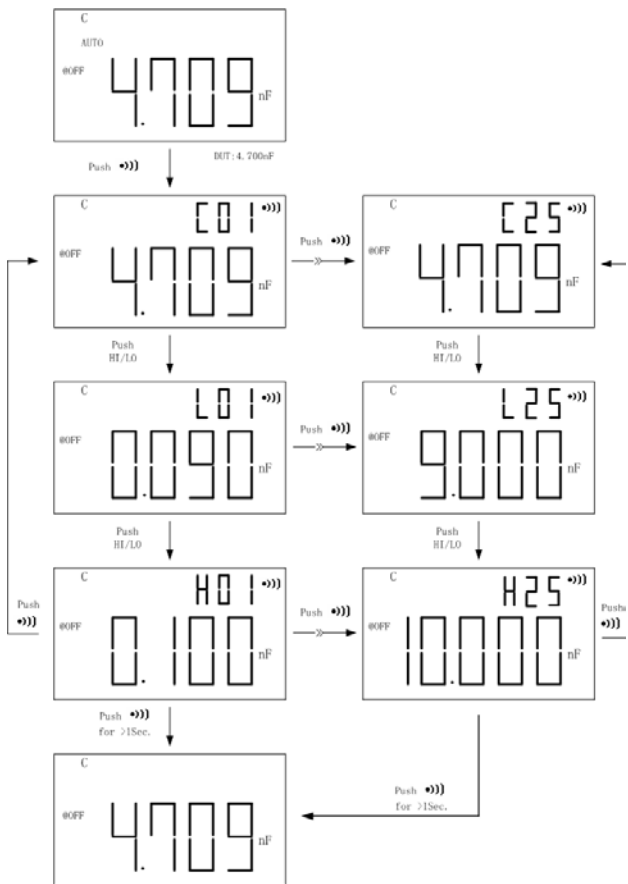

Figure 23 - Steps to Setup Compare Mode

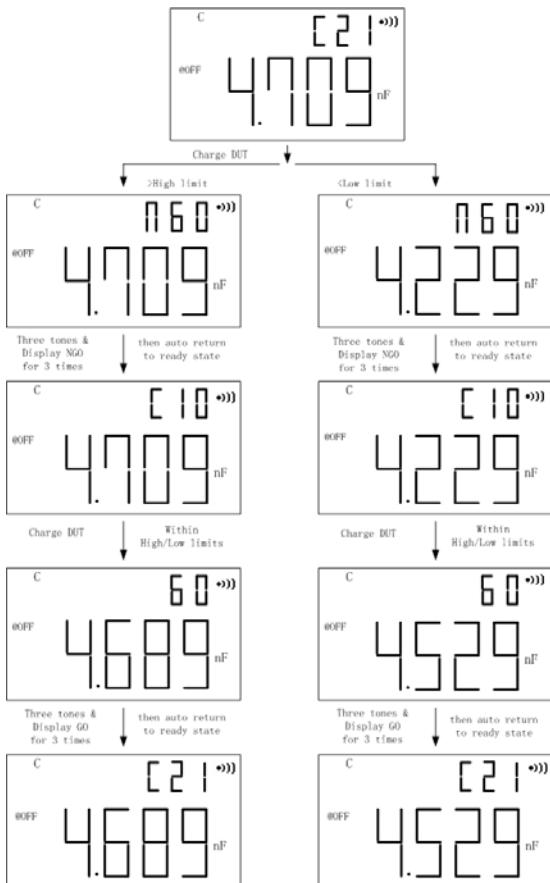

Figure 24 - Steps to Sort by Compare Mode

Setting HI and LO Limits

The yellow keys from the front key buttons are used for setting HI and LO limits for compare testing. The



button enters the HI/LO limit setup menu.



The arrow buttons , , and



are used to adjust the HI/LO sets and HI/LO

limit values. The







button is used to save the adjusted limit values.

Follow the below procedure to configure HI/LO limits.

1. Press and hold  for two seconds to enter HI/LO limit setting mode.
2. The secondary display will flash "**L01**" and the primary display will indicate the limit value. Default is displayed as "**0090**". This indicates the limit value for the first set for the "**LO**" limit.



Use the or button to select the digits of the limit value, going left or right respectively. The digit that is blinking rapidly indicates the current selection.

- Once the digit you want to adjust is blinking, use the  or  to increase or decrease the value of the blinking digit.
- Once the desired limit value is set, press and hold  button for two seconds or until all the digits on the primary display stops blinking.
- To set the “**HI**” limit value for the first set, press the  button once and the secondary display will show “**H01**” blinking slowly.
- To adjust the next set of limit values, simply press the  button once. The secondary display will now show either “**H02**” or “**L02**” depending on whether the last set limit was for HI or LO.
- Repeat steps 2-5 for this second set of limits. The meter can store up to 25 different limit sets. Repeating the above steps will cycle through “01”, “02”, “03”, ... , “25”. After the 25th set, it will go back to the 1st set again.

Exit HI/LO Limit Menu

Once all limit values are configured for all the sets to be used, hold and press the  button for two seconds to exit.

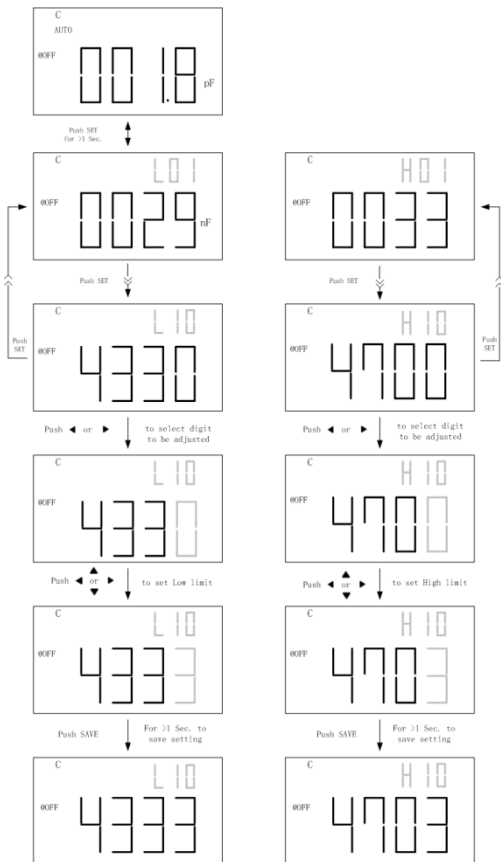

Figure 25 - Steps to Set H/LO Limits

REMOTE COMMUNICATION

The meter has the capability to communicate with a PC over the mini USB interface. Upon installation of a USB driver, the PC can control the instrument over virtual COM. The mini USB communication interface of the meter is fully duplex and has a 64-byte input and output buffer, making it reliable and efficient for data transmission.

Connecting Instrument to PC

Follow the below procedures for connection setup.

1. Download the USB drivers from www.bkprecision.com .
2. With the included mini USB cable, connect the mini USB end to the capacitance meter and the other end to an available USB port on the PC.
3. When Windows recognizes the USB connection, do not follow the default Windows driver installation wizard. Simply run the setup file from the downloaded USB drivers and follow the prompt to install drivers.
4. When completed, the computer will recognize the instrument as a USB (virtual COM) device, meaning it will be detected as a serial COM

port. Windows will automatically assign a COM port to the instrument. Please verify which COM port Windows has assigned by going into “Device Manager”.

USB (Virtual COM) Configuration

The USB will be recognized as a virtual COM on the PC, thus serial port settings must be configured properly for remote communication to be successful. Below are the default settings used by the 830C and 890C meters. They can be changed within the setup menu. See SETUP OPTIONS section for details.

- Baudrate: **9600**
- Data bits: **8**
- Parity: **None**
- Stop bits: **1**
- Flow Control: **None**

Remote Mode

Upon connecting to the instrument, sending any commands listed in the “Command Protocols” section will automatically set the meter into remote mode. In remote mode, the LCD display will show the RMT indicator.

Command Protocols

Overview of Command Type and Format

All commands are entered in either the upper case or the lower case. There are two types of the meter programming commands: IEEE 488 common commands and Standard Commands for Programmable Instruments (SCPI). Some commands are device-specific to the meter. They are not included in the version 1999.0 of the SCPI standard. However, these commands are designed with the SCPI format in mind and they follow the syntax rules of the standard.

Common Command Format

The IEEE 488 standard defines the common commands as commands that perform functions like reset and system query. Common commands usually come with the asterisk "*" character, and may include parameters. Some examples of Common command like: *IDN?, GTL, LLO.

SCPI Command Format and Query Format

The SCPI commands control instrument functions. A subsystem command has a hierarchical structure that usually consists of a top-level (or root) keyword, one or more lower level keywords, and parameters. The

following example shows a command and its associated query:

```
CONFigure:CAPacitance 10u
```

Set the primary display to the capacitance measurement, and select the 10 uF range.

```
CONFigure?
```

Return the function of the primary display measurement.

CONFigure is a root level keyword with the second level keyword, CAPacitance, and 10u is the command parameter. The query command ends with a question mark “?”.

Note: *SCPI stems from IEEE488.1 and IEEE 488.2. Although the IEEE 488.2 standard addressed some instrument measurements, it principally dealt with common commands and syntax or data formats. Please refer to the IEEE488.2 and SCPI reference manual for more information.*

Termination Character

A terminator is a character sent by a host, which identifies the end of a command string. A valid terminator consists of two-byte data:

<CR> (Carriage Return, ASC(&H0D)) or <LF> (Line Feed, ASC(&H0A)) or <CR><LF>

Responding Message

Returned result

After the meter executes a query command, the return of the result will be in the following format:

<Result> + <CR> <LF>

For example, in auto fetching mode, the meter will send the measured data automatically when the measurement cycle is completed. The format of the printed data will be shown as the following:

<Result > + <CR> <LF>

Data Types

Returned message is an ASCII string from the meter responding to a query. A query is a command accompanied a “?” mark. Table 3 below explains the different data types.

Table 3 - Data Type of Responded Messages

Data Type	Explanation	Example
<NR1>	An integer	+800,-200,100,-50
<NR2>	This numeric representation has an explicit radix point	+1.56,-0.001,10.5
<NR3>	This representation	+2.345678E+04

	has an explicit radix point and an exponent	-1.345678E-01
<Boolean>	A parameter for Boolean setting. Always return "0" or "1" for Boolean query command	ON or OFF
<Literal>	A string is used as command parameters with short literal form	HOLD

SCPI Commands

This section described all the SCPI commands supported by the meter. The meter can accept both upper case and lower case commands.

Table 4 - SCPI Symbol Conventions

Text Symbol	Meaning
[]	Option; can be omitted
	Exclusive OR

< >	Defined element
()	Comment
?	Question mark
:	Separated two command keywords

*IDN?

Description: Queries the instrument ID.
 Response: <instrument model>, <firmware version>, <serial number>

LLO

Local Lockout. This means that all front panel buttons

are disabled except for  button.

GTL

Go to local. Puts the meter into the local state, clearing the remote state and front panel lockout.

CONFigure Subsystem

CONFigure:CAPacitance [<range>]

Description: Set to 2-wire capacitance measurement.

Parameter:

<range> : Measuring unit is Farad. Parameters are 1000p, 10n, 100n, 1u, 10u, 100u, 1m, 10m and 50m (will be 200m range for 830C). The meter is set to auto range when the parameter is omitted.

Example: CONF:CAP 100u ; Set to capacitance function and 100 μ F range.

CONFigure?

Description: Query the function of the primary display.

Response: Return <"function range, resolution"> format string, the examples are as following:

CAP +1.000000E- 07,+1.000000E-1	Capacitance	100nF	0.01nF
---------------------------------------	-------------	-------	--------

CALCulate Subsystem:

**CALCulate:FUNCTion NULL
TOLerance
LIMit
AVERage
NONE**

Description: Enable or disable the function of the calculation.

Parameter:

NULL – enable null (relative) function;

TOL – enable tolerance function;

LIM – enable limit function;

AVER – enable average (static recording) function;

NONE – disable all calculation and select the internal trigger source.

Example: CALC:FUNC AVER

Note: The trigger source is changed to immediate when the AVERage function is enabled.

User can combine TOL/NULL, LIM/NULL, AVER/NULL or NULL/AVER functions, but the other combinations are void.

CALCulate:FUNction?

Description: Query the function of the calculation.

Response: Return <Literal> format string: AVER, TOL, LIM, NULL or NONE.

For combined modes, string can be: TOL,NULL; LIM,NULL; AVER,NULL

Example: Returning AVER, NULL means the record function and the relative function being enabled.

CALCulate:NULL:OFFSet?

Description: Query the offset value of the null (relative) function.

Response: Return <NR3> format string.

Note: If relative function is disabled, querying the offset of relative mode will return an error. Re-enable in order to get a returned value. Use CALCulate:NULL:STATe command shown below to control the relative function.

CALCulate:NULL:STATe <Boolean>

Description: Enable or disable the null (relative) function of the calculation.

Example: CALC:NULL:STAT OFF

CALCulate:AVERage

:MAXimun?

:MINimun?

:AVERage?

:PRESent?

Description: Query the value of the static dynamic recording function.

Response: Return <NR3> format string.

Example:

CALC:AVER:MAX? ; Query the maximum recorded value.

CALC:AVER:MIN? ; Query the minimum recorded value.

CALC:AVER:AVER? ; Query the average recorded value.

CALC:AVER:PRES? ; Query the present recorded value.

Note: If static recording function is disabled, all queries will return an error message on display until the function is re-enabled again. Use CALCulate:AVERage:STATe command shown below to control static recording function.

CALCulate:AVERage:STATe <Boolean>

Description: Enable or disable the static recording function of the calculation.

Example: CALC:AVER:STAT OFF

CALCulate:LIMit

:MODE <mode>

:LOWer <mode>, <value>

:UPPer <mode>, <value>

Description: Set the mode or the value of the Limit function.

Parameter:

<mode>: The value of mode is from 01 to 25.

<value>: The limit value is from 00000 to 11000.

Example:

CALC:LIM:MODE 01 ; Apply the settings of the mode 1.

CALC:LIM:UPP 07,01000 ; Set the upper limit value of the 7th set.

CALCulate:LIMit

:MODE?

:LOWer? <mode>

:UPPer? <mode>

Description: Query the mode or the value of the Limit function.

Parameter: <mode>: The value of mode is from 01 to 25.

Response: Return <NR1> format string.

Example:

CALC:LIM:MODE? ; Query the mode of the Limit function.

CALC:LIM:UPP? 07 ; Query the upper value of the mode 7.

Note: CALCulate:LIMit:MODE? Query will respond with an error if meter is not in limit function and if the state of limit function is disabled. To set meter to limit function, use the CALCulate:FUNcTION command.

CALCulate:LIMit:STATe <Boolean>

Description: Enable or disable the Limit function of the calculation.

Example: CALC:LIM:STAT OFF

CALCulate:TOLerance:RANGe <1 | 5 | 10 | 20>

Description: Set the tolerance range of the Tolerance function.

Example: CALC:TOL:RANG 5 ; Set 5% tolerance range.

Note: Tolerance range can only be set when tolerance function mode is set. When this function is not set as the current mode, CALCulate:TOLerance:RANGe command will return an error on display.

CALCulate:TOLerance:BASE?

Description: Query the base value of the tolerance function.

Response: Return <NR3> format string.

CALCulate:TOLerance:VALue?

Description: Query the tolerance value of the tolerance function.

Response: Return <NR3> format string.
The returned value will not be in terms of %. For example, if display shows 0.35%, return value could be 3.535005e-03

CALCulate:TOLerance:STATe <Boolean>

Description: Enable or disable the tolerance function of the calculation.

Example: CALC:TOL:STAT OFF

TRIGger:Subsystem:

TRIGger:SOURce < BUS | IMMEDIATE >

Description: Select a source of the trigger signal.

Parameter:

BUS – select a bus command source and enter the trigger (hold) mode. In this mode, data hold will be activated to hold each measured reading after trigger is received from the bus.

IMM – select the internal trigger source.

Example: TRIG:SOUR BUS

Note: The AVERage function will be disabled when entering into trigger mode.

TRIGger:SOURce?

Description: Query the type of the trigger source.

Response:

Return <Literal> format string: BUS, IMM.

Measuring Subsystem:

FETCh?

Description: Return the primary display value of device's output buffer. Retrieves the measurements taken by the INITiate command and places them into the device's output buffer. The query can return data any time that the last reading is valid. The meter generates an error -230 and no result is returned when the meter is in the trigger idle state and the data is invalid.

Response: Return <NR3> format string.

Example: FETC? ; Return a primary display value, e.g. +1.23450000E+00.

SYSTEM Subsystem

SYSTEM:ERRor?

Description: Query the error message.

Response: Return <Number, "Error String"> format string. Table 4 is a list of SCPI error message that might occur during operation.

Note: The buffer size of the system error queue is one. Keep the last error.

Table 4 SCPI Error Message

Number	Error String	Number	Error String
+0	No error	-200	Execution error
-100	Command error	-220	Parameter error

SYSTEM:VERsion?

Description: Query the version of the SCPI.

Response: Return 1999.0 string.

SYSTEM:BEEP <Boolean>

Description: Enable or disable the key beep.

Parameter: <Boolean>: ON; OFF.

SYSTEM:BLIT <Boolean>

Description: Enable or disable the backlit.

Parameter: <Boolean>: ON; OFF.

Note: The backlit is turned off automatically when the backlit time isn't zero and the time comes up.

SYSTEM:BLIT:TIME <second>

Description: Set a backlit time.

Parameter: <second>: 0 ~ 99. Set "0" to disable auto off backlit function.

Note: Stored in non-volatile memory.

SYSTem:AOff:TIME <minute>

Description: Set an auto power off time.

Parameter: <minute>: 0 ~ 99. Set "0" to disable auto power off function.

Note: Stored in non-volatile memory.

SYSTem:DEFAult

Description: Setting default value to the non-volatile memory includes SETUP value but don't affect the other calibrated data.

STATus Subsystem:

STATus?

Description: Query the status of the meter.

Response: Returns a
<"ABCDEFGHIJKLMNopQRSTU"> format string
(21 characters).

Each character represents the following:

	Item	Explanation
A	Average function	0:off, 1:on
B	Null function	0:off, 1:on
C	Limit	0:off, A:mode 1 ~

	function	Y:mode 25
D	Limit result	0:none, 1:Go, 2:Lo nGo, 3:Hi nGo
E	Tolerance function	0:off, 1:1%, 2:5%, 3:10%, 4:20%, F:no range setting
F	Tolerance Result	0:none, 1:pass, 2:fail
G	Trigger source	I:IMM, B:BUS
H	Unused	always 0
I	Unused	always 0
J	Beep	0:off, 1:on
K	Auto Power Off	0:off, 1:on
L	Back lit	0:off, 1:on
M	Meter mode	L:normal
N	Unused	always 0
O	Unused	always 0
P	Unused	always 0
Q	Unused	always 0
R	Rate	always 1
S	Battery	0:normal, 1:low
T	Unused	always 0
U	Auto range	0:off, 1:on

Summary of SCPI Commands

Command	Parameter	Explanation
CONFigure?		Query display function
CONFigure :CAPacitance	[<range>]	Configure the meter perform specified measurement
CALCulate		
:FUNCTion?		Query the calculation function.
:FUNCTion	<function>	Set a calculation function.
:NULL		
:OFFSet?		Query the offset value of the relative function
:STATe	<Boolean>	Enable/disable the relative function
:AVERage		
:MAXimum?		Query the value of the static recording function
:MINimum?		
:AVERage?		
:PRESent?		
:STATe	<Boolean>	Enable/disable the static recording function
:LIMit		
:MODE	<mode>	Set the value of the limit function
:UPPer	<mode>,<value>	
:LOWer	<mode>,<value>	
:MODE?		Query the value of the limit function
:UPPer?	<mode>	

	:L C V e r ?		
:STATe	<Boolean>	Enable/disable the limit function	
:TOLerance			
:RANGe	<1 5 10 20>	Set the value of the Tolerance function	
:BASE?		Query the value of the Tolerance base	
:VALue?		Query the tolerance value	
:STATe	<Boolean>	Enable/disable the tolerance function	
TRIGger			
:SOURce?		Query the trigger	

		source type
:SOURce	<BUS IMM>	Select a trigger source
FEtCh?		Returns a data any time that the last reading is valid.
SYSTem		
:AOFF:TIME	<minute>:0~99	Set an auto power off time
:BLIT	<Boolean>	Enable or disable the backlit
:TIME	<second>:0~99	Set a backlit time
:BEEP	<Boolean>	Enable or disable the buzzer.
:DEFAult		Set default value to the non-volatile memory
:ERRor?		Query error message
:VERSion?		Query version of the SCPI
STATus?		Query the status

Error Codes

In certain situations, errors may occur, and an error code will be displayed on the meter. Below defines the error description based on the error code.

Err0r 1: Unknown command

Err0r 2: Parameter Error

Err0r 3: Syntax Error

MEASUREMENT TIPS

To avoid possible damage to the meter or the equipment under test, disconnect circuit power and discharge the capacitor before measuring capacitance.

Capacitance is the ability of a component to store an electrical charge. The unit of capacitance is the farad (F). Most capacitors are within the range of nanofarad (nF) to microfarad (μF). The meter measures capacitance by charging the capacitor with a known current, measuring the resulting time of the charging period, and then calculating the capacitance. The larger capacitors will take longer time to charge. Some large capacitors can take over a minute to measure due to the long charge time required. A flashing "C" indicates charging capacitor. To improve the measurement accuracy of a small value capacitance, press REL with the alligator clip leads open, to subtract the residual capacitance of the meter and leads.

Measuring tip: For measuring capacitance greater than $1000\mu\text{F}$, you must discharge the capacitor first, then select a suitable measurement range. This will speed up the time to measure the correct value.

1. Turn on the meter.
2. If you are using alligator clip leads or SMD tweezer to test capacitance, connect them to the "+" and "-" input sockets. Then press REL

- to subtract the residual capacitance of the meter and leads or tweezer.
3. Insert the leads of capacitor into “+” and “-” input sockets, respectively. If you are using alligator clip leads or SMD tweezer, connect the “+” and “-” ends to the capacitor respectively.
 4. Be sure the polarity of the capacitor to the leads or tweezer or to the input socket of the meter is correct.
 5. Remove your hands from capacitor.
 6. Read the display.

Measuring large capacitors: Measuring very large capacitors, for example a 100 mF value, requires a long time. . In this case, after inserting the capacitor into the meter’s terminals, the meter display may seem unresponsive and not respond to key presses. This is normal, and indicates that the meter is currently charging the capacitor. Depending on the size of the capacitor, this charging period can take up to 2 minutes until the meter becomes responsive and display the result. If manual range is to be used, please set to the correct range first before inserting the capacitor. Otherwise, it will take much longer to make the measurement.

When using tolerance and compare mode, it will also take longer time for the meter to respond with readings if large capacitors are being tested.

SUPPLEMENTAL INFORMATION

Guard Terminal

One of the input sockets and terminals is labeled as **“GUARD”**. This terminal does not have to be used in all instances for the meter to make measurements. But in some instances, it is very useful.

The guard terminal is used to minimize noise and to help minimize parasitic components of the capacitor to be measured, thus allowing for more accurate results.

SPECIFICATIONS

Below are some remarks in regards to all specifications pertaining to both 830C and 890C capacitance meters.

*Specifications are subject to change without notice.

The following conditions must be met for the specifications to be valid:

1. Measurements are performed at the test socket.
2. DUT and test leads must be properly shielded via the guard terminal if necessary.
3. Measurements are made after 30 minutes of warm up time and operated at $23\text{ }^{\circ}\text{C} \pm 5\text{ }^{\circ}\text{C}$, $<75\%$ R.H.
4. Accuracy specification valid for measurements within 10% to 100% of full scale of range; values outside of range should be used for reference only.
5. Battery powered operation.

General specification

Display:

- 5 digit liquid crystal display (LCD) with maximum reading of 11000 counts.
- Automatic polarity indication.

Function:

- Capacitance measurement by DC charge and discharge method.
- Visible and audible Tolerance mode assists you to sort capacitors
- Min/Max/Average, Data Hold with Manual or Auto Trigger and Relative modes
- Comparison mode with 25 sets of HI/LO limits can be selected
- Backlit display for easy reading in the dark.
- USB (virtual com) computer interface with SCPI commands
- One-year calibration cycle suggested.

Measuring rate (Approx.):

5 times /s for capacitance <100 μ F.

Low battery indicator:

The " " appears when the battery voltage drops below 6V (approx.).

Operating temperature:

0°C to 40 °C (32°F~113°F)

Storage temperature:

-20°C to 50°C (-4°F~122°F) without battery

Relative Humidity (R.H.) :

Maximum 80% R.H. for temperature up to 31°C decreasing linearly to 50% R.H. at 40°C

Temperature coefficient

0.1 * (specified accuracy) / °C (from 0°C to 18°C or 28°C to 40°C)

Power supply:

Single standard 9V Battery or AC power adapter

Power Consumption:

270 mVA maximum with backlit on

Battery life:

70 hours without backlit (approx.) (Based on new alkaline 9V/545m A Battery)

Dimension (HxWxL):

1.6 x 3.5 x 7.5 inches (41 x 90 x 190 mm)

Weight:

0.77 lbs. (350 g) with battery

Standard Accessories:

Alligator clip leads, 9V battery, Mini USB Cable, and Instruction manual.

Safety Standard:

Designed in compliance with EN61010-1 (IEC1010-1) for CAT-II 50V, Pollution Degree II Environment. EMC designed in compliance with EN61326-1.

Electrical specifications

Accuracy is given as (% of reading + counts of least significant digit) at 23°C ± 5°C, with relative humidity less than 80% R.H.

Capacitance

Range	Resolution	Accuracy*	Measuring rate as full scale (approx.)
1000.0 pF	0.1 pF	1% + 10	5 times /sec
10.000 nF	0.001 nF	1% + 5	5 times /sec
100.00 nF	0.01 nF	0.5% + 3	5 times /sec
1000.0 nF	0.1 nF		5 times /sec
10.000 µF	0.001 µF		5 times /sec
100.00 µF	0.01 µF		5 times /sec
1000.0 µF	0.1 µF		0.86 times /sec
10.000 mF	0.001 mF	1% + 5	0.13 times /sec
50.00 mF (890C) 199.99 mF (830C)	0.01mF	2% + 5	0.026 times /sec 0.006 times /sec

*= The accuracy is specified to measure film capacitor or better, and use Relative mode to zero residual first.

Notes:

1. Overload protection: 250VR.M.S.

Specifications are subject to change without notice.

To ensure the most current version of this manual, please download the current version here: <http://www.bkprecision.com/search/manual/830C>

For current up-to-date product information, please visit www.bkprecision.com

MAINTENANCE

WARNING: Do not perform any service by yourself. Service should only be done by qualified personnel and trained technicians.

Service

If the instrument fails to operate, check battery and test leads. Replace them as necessary. If the instrument still cannot work, verify with the operating instructions to make sure correct procedures are followed.

When servicing, use specified replacement parts only.

Note: *The meter must be completely turned off while replacing the battery. Refer to “Installing Battery” section for details.*

Troubleshoot Tips

The following table will guide you to identify basic problems:

Malfunction	Identification
No LCD indication at power ON	● Check battery or replace battery.
No beeper tone	● Check setup mode whether the beeper has been set to OFF.

Push buttons failure	<ul style="list-style-type: none"> ● Check whether the meter is under remote control. ● Turn OFF and then turn ON the meter again. ● Check the setup mode whether “Lbut” of lock buttons has been set “on”.
Failed on Remote control	<ul style="list-style-type: none"> ● Check the baud rate, parity, Data bit, Stop bit (default is 9600, n, 8, 1) ● Check USB driver installation.
Display is frozen and buttons do not respond	<ul style="list-style-type: none"> ● If a large capacitor is being measured, this is normal as it takes a long time to charge the capacitor in order to make an accurate measurement. In some cases, it can take up to 2 minutes. During this time, buttons may not respond. In this case, wait a while and try again or unplug your capacitor and configure your settings, then reconnect the capacitor to the terminals.

Cleanin

WARNING: To avoid electrical shock or damaging the meter, prevent water from getting inside the case. In the case that water gets inside, remove the battery immediately and do not operate the instrument immediately. Doing so will immediately damage the instrument and void its warranty.

Before cleaning this meter, make sure the power is OFF and remove external AC adapter if one is used. To clean the meter, wipe the dirty parts with a soft cloth soaked with diluted neutral detergent. Avoid having the instrument too wet to prevent the detergent from penetrating into the inside components of the meter, causing damages. After cleaning, make sure the instrument is completely dried before operating it again.

SERVICE INFORMATION

Warranty Service: Please go to the support and service section on our website www.bkprecision.com to obtain a RMA #. Return the product in the original packaging with proof of purchase to the address below. Clearly state on the RMA the performance problem and return any leads, probes, connectors and accessories that you are using with the device.

Non-Warranty Service: Please go to the support and service section on our website www.bkprecision.com to obtain a RMA #. Return the product in the original packaging to the address below. Clearly state on the RMA the performance problem and return any leads, probes, connectors and accessories that you are using with the device. Customers not on an open account must include payment in the form of a money order or credit card. For the most current repair charges please refer to the service and support section on our website.

Return all merchandise to B&K Precision Corp. with pre-paid shipping. The flat-rate repair charge for Non-Warranty Service does not include return shipping. Return shipping to locations in North America is included for Warranty Service. For overnight shipments and non-North American shipping fees please contact B&K Precision Corp.

B&K Precision Corp.
22820 Savi Ranch Parkway
Yorba Linda, CA 92887
www.bkprecision.com
714-921-9095

Include with the returned instrument your complete return shipping address, contact name, phone number and description of problem.

LIMITED WARRANTY

B&K Precision Corp. warrants to the original purchaser that its products and the component parts thereof, will be free from defects in workmanship and materials for a period of three years from date of purchase.

B&K Precision Corp. will, without charge, repair or replace, at its option, defective product or component parts. Returned product must be accompanied by proof of the purchase date in the form of a sales receipt.

To obtain warranty coverage in the U.S.A., this product must be registered by completing a warranty registration form on our website www.bkprecision.com within fifteen (15) days of purchase.

Exclusions: This warranty does not apply in the event of misuse or abuse of the product or as a result of unauthorized alterations or repairs. The warranty is void if the serial number is altered, defaced or removed.

B&K Precision Corp. shall not be liable for any consequential damages, including without limitation damages resulting from loss of use. Some states do not allow limitations of incidental or consequential damages. So the above limitation or exclusion may not apply to you. This warranty gives you specific rights and you may have other rights, which vary from state-to-state.

B&K Precision Corp.
22820 Savi Ranch Parkway
Yorba Linda, CA 92887
www.bkprecision.com
714-921-9095

INDEX

- Auto Power Off
(AOFF), 41
- Backlit, 27
- Battery, 22
- Baud Rate (bAUd), 33
- Compare Mode, 65
- Data Bits (Data), 36
- Data Hold, 51
- dEFA, 49
- Echo (ECHO), 37
- Error Codes, 98
- External Power, 24
- Firmware, 30
- Guard Terminal, 101
- HI and LO Limits, 71
- Key Beeper (bEEP),
39
- LCD Display, 18
- Lock Buttons (LbUt),
40
- Low Battery, 27
- Parity (PArT), 35
- Print Only(Prnt), 38
- Relative Mode, 57
- Remote Mode, 76
- SCPI, 77
- Setup Menu, 30
- Static Recording, 53
- Tolerance, 60
- USB drivers, 75

BK PRECISION®

22820 Savi Ranch Parkway
Yorba Linda, CA 92887
www.bkprecision.com

© 2011 B&K Precision Corp.