

BK PRECISION®

Model: 4033, 4034

50 MHz Programmable Pulse Generator

USER MANUAL



Safety Summary

The following safety precautions apply to both operating and maintenance personnel and must be observed during all phases of operation, service, and repair of this instrument. Before applying power, follow the installation instructions and become familiar with the operating instructions for this instrument.

Failure to comply with these precautions or with specific warnings elsewhere in this manual violates safety standards of design, manufacture, and intended use of the instrument. B&K PRECISION assumes no liability for a customer's failure to comply with these requirements.

GROUND THE INSTRUMENT

To minimize shock hazard, the instrument chassis and cabinet must be connected to an electrical ground. This instrument is grounded through the ground conductor of the supplied, three-conductor ac power cable. The power cable must be plugged into an approved three-conductor electrical outlet. Do not alter the ground connection. Without the protective ground connection, all accessible conductive parts (including control knobs) can render an electric shock. The power jack and mating plug of the power cable meet IEC safety standards.

DO NOT OPERATE IN AN EXPLOSIVE ATMOSPHERE

Do not operate the instrument in the presence of flammable gases or fumes. Operation of any electrical instrument in such an environment constitutes a definite safety hazard.

KEEP AWAY FROM LIVE CIRCUITS

Instrument covers must not be removed by operating personnel. Component replacement and internal adjustments must be made by qualified maintenance personnel. Disconnect the power cord before removing the instrument covers and replacing components. Under certain conditions, even with the power cable removed, dangerous voltages may exist. To avoid injuries, always disconnect power and discharge circuits before touching them.

DO NOT SERVICE OR ADJUST ALONE

Do not attempt any internal service or adjustment unless another person, capable of rendering first aid and resuscitation, is present.

DO NOT SUBSTITUTE PARTS OR MODIFY THE INSTRUMENT

Do not install substitute parts or perform any unauthorized modifications to this instrument. Return the instrument to B&K Precision for service and repair to ensure that safety features are maintained.

WARNINGS AND CAUTIONS

WARNING and **CAUTION** statements, such as the following examples, denote a hazard and appear throughout this manual. Follow all instructions contained in these statements.

A **WARNING** statement calls attention to an operating procedure, practice, or condition, which, if not followed correctly, could result in injury or death to personnel.

A **CAUTION** statement calls attention to an operating procedure, practice, or condition, which, if not followed correctly, could result in damage to or destruction of part or all of the product.

WARNING: *Do not alter the ground connection. Without the protective ground connection, all accessible conductive parts (including control knobs) can render an electric shock. The power jack and mating plug of the power cable meet IEC safety standards.*

WARNING: *To avoid electrical shock hazard, disconnect power cord before removing covers. Refer servicing to qualified personnel.*

CAUTION: *Before connecting the line cord to the AC mains, check the rear panel AC line voltage indicator. Applying a line voltage other than the indicated voltage can destroy the AC line fuses. For continued fire protection, replace fuses only with those of the specified voltage and current ratings.*

CAUTION: *This product uses components which can be damaged by electro-static discharge (ESD). To avoid damage, be sure to follow proper procedures for handling, storing and transporting parts and subassemblies which contain ESD-sensitive components.*

Compliance Statements

Disposal of Old Electrical & Electronic Equipment (Applicable in the European Union and other European countries with separate collection systems)

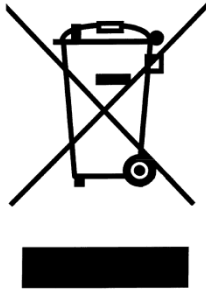

This product is subject to Directive 2002/96/EC of the European Parliament and the Council of the European Union on waste electrical and electronic equipment (WEEE) , and in jurisdictions adopting that Directive, is marked as being put on the market after August 13, 2005, and should not be disposed of as unsorted municipal waste. Please utilize your local WEEE collection facilities in the disposition of this product and otherwise observe all applicable requirements.

Safety Symbols



Connect to safety earth ground using the wire recommended in the user manual.



This symbol on an instrument indicates that the user should refer to the operating instructions located in the manual.



Electrical Shock hazard.

Table of Contents

Safety Summary	2
Section 1	6
Introduction	6
1.1 Introduction	6
1.2 Description	6
1.3 Safety Remarks	6
1.4 Package Contents	6
Specifications.....	6
Section 2	9
Installation.....	9
2.1 Introduction	9
2.2 Mechanical Inspection	9
2.3 Initial Inspection	9
2.4 Instrument Mounting	9
2.5 Product Dimensions	9
2.6 Power Requirements	10
2.7 Grounding Requirements	10
2.8 Signal Connections.....	10
2.9 RS-232 Connection	13
2.10 RS-232 Configuration	14
2.11 GPIB Address.....	14
2.12 GPIB Connections	14
Section 3	15
Operating Instructions	15
3.1 General Description	15
3.2 Display Window	16
3.3 Front Panel Controls.....	17
3.4 Back Panel Controls	17
3.5 Output connectors	19
3.6 MENU Keys	19
3.7 ON Key	29
3.8 Cursor Movement Keys	29
3.9 Rotary Input Knob.....	29
3.10 Power-On Settings	29
3.11 Memory	30
3.12 Displaying Errors	30
3.13 Pulse Definitions	31
3.14 Pulse Parameter Limitations.....	32
3.15 Pulse Definitions	33
Section 4	35
Programming.....	35
4.1 Overview	35
4.2 Device State	36
4.3 Interface Function Subsets.....	37
4.4 Device Address.....	37
4.5 Message Exchange Protocol.....	37

4.6 Instrument Identification	38
4.7 Instrument Reset	38
4.8 Self Test.....	38
4.9 Command Syntax	39
4.10 Status Reporting	41
4.11 IEEE 488.2 Common Commands and Queries.....	45
4.12 Instrument Control Commands.....	48
4.13 IEEE 488.1 Interface Messages	64
4.14 SCPI Command Tree	65
4.15 ASCII and GPIB Code Chart	67
4.16 RS-232 Programming.....	69

Section 1

Introduction

1.1 Introduction

This manual contains information required to operate, program, check, and maintain the 50 MHz programmable pulse generator.

1.2 Description

The Model 4033 and 4034 are a high performance programmable pulse generators. The instrument generates pulse with a repetition rate to 50 MHz, width from 10 ns, variable delay, variable transition times and amplitude. The pulses can be output in continuous, triggered, gated, or burst mode with an internal or external trigger signal.

The model 4033 and 4034 can be remotely operated via RS232 or GPIB interface bus and is SCPI compatible.

1.3 Safety Remarks

The model 4033 and 4034 are SAFETY CLASS 1 instruments. Before operation, review the safety summary at the beginning of the manual.

1.4 Package Contents

The following list of items and accessories come in the package:

1. 4033 or 4034 Pulse Generator
2. AC power cord
3. CD containing user manual
4. Test report and certificate of calibration
5. RS-232 Serial Cable

Specifications

NOTE

Specifications listed in manual are applicable after a powered 30 minute warm-up into a 50 Ω load
All timing characteristics are measured at 50% of amplitude with fastest edge
Specifications are verified according to the performance check procedures.
Specifications not verified in the manual are either explanatory notes or general performance characteristics only.
Specifications and information is subject to change without notice. For the most current and correct data please visit www.bkprecision.com

MODELS		4033	4034
CHANNELS		1	2
FREQUENCY		0.1 Hz to 50 MHz	
TIMING CHARACTERISTICS			
PERIOD	Range (single pulse)	20 ns to 10 s (50 MHz to 0.1 Hz repetition rate)	
	Range (double	40 ns to 10 s (25 MHz to 0.1 Hz repetition rate)	

	pulse)	
	Resolution	Up to 6 digits, limited to 10 ps
	Accuracy	$\pm 0.01\%$
	Jitter	$< 0.01\%$ of setting +20 ps on Period, Width and Delay
WIDTH	Range	10 ns to (Period – 10 ns)
	Resolution	Up to 6 digits, limited to 100 ps
	Accuracy	$\pm(0.5\%$ of setting +500 ps)
	Double Pulse	$\pm(0.5\%$ of setting +3 ns) for the second pulse
DELAY	Range	0ns to (Period – Width – 10 ns)
	Resolution	Up to 6 digits, limited to 100 ps
	Accuracy	$\pm(0.5\%$ of setting +500 ps)
DUTY CYCLE	Range	1 to 99%
	Resolution	3 digits (0.1%)
	Accuracy	Limited by width and pulse accuracy
OUTPUT CHARACTERISTICS		
AMPLITUDE	High Level Range	-9.90 V to +10 V into 50 ohms load (-19.80 V to +20 V into open circuit)
	Low Level Range	-10 V to +9.90 V into 50 ohms load (-20 V to +19.80 V into open circuit)
	Amplitude Range	0.1V to 10V p-p into 50 ohms load (20 Vp-p max into open circuit)
	Resolution	3 digits limited to 10 mV
	Accuracy	$\pm 1\%$ of setting ± 10 mV into 50 ohms
	Aberrations	$<5\%$ + 20 mV into 50 ohms load, for pulse levels between ± 5 V
	Output Resistance	50 ohms
	Offset Accuracy	$\pm 1\% \pm 25$ mV
OPERATING MODES		
	Continuous	Output continuous at programmed period rate
	Triggered	Output quiescent until triggered by an internal, external, GPIB or manual trigger, then generates one cycle at programmed period rate
	Gated	Same as triggered mode except pulses are output for the duration of the gated signal. The last cycle started is completed
	Burst	Same as triggered mode for programmed number of cycles from 2 to 999,999 as set by the N-BURST function
	External Width	Trigger duration and rate sets pulse width and repetition
PULSE FUNCTIONS		
	Single	One pulse at each selected period up to 50 MHz repetition rate
	Double	One pair of pulses at each period up to 25 MHz repetition rate. Both pulses have the same selected width; the position of the second pulse set by the delay control.
TRANSITION TIMES		
	Range	<6 ns to 100 ms variable. Leading and trailing edges settable separately and limited to 20:1 ratio between settings into one of the following ranges: 5ns-100 ns; 50 ns-1.0 us; 500 ns-10 us; 5.0 us-100 us; 50 us-1.0 ms; 500 us-10 ms, 5 ms – 100 ms
	Resolution	3 digits limited to 10 ps
	Accuracy	$\pm(5\%$ of setting +2ns)
	Linearity	$<5\%$ deviation from a straight line between 10% and 90% points, for transitions > 50 ns
INTERNAL TRIGGER		
	Range	100 ns to 100 s
	Resolution	4 digits limited to 100 ns
	Accuracy	$\pm 0.01\%$
INPUT AND OUTPUT		

TRIGGER INPUT	Sensitivity	200 mVp-p minimum
	Minimum Width	10 ns
	Maximum Rate	50 MHz
	Input Impedance	10 k Ω
	Input Protection	± 15 V DC plus peak AC
	Range	Selectable from -10 V to +10 V
	Resolution	3 digits limited to 10 mV
	Slope Selection	Positive or Negative
SYNC OUTPUT	A TTL level pulse at the programmed period. Output impedance is 50 Ω , protected against short circuit and up to ± 15 V accidental input. The high level is >2 V into 50 ohms and with 3.5 ns typical transition times.	
GPIB PROGRAMMING		
Interface	GPIB and RS-232, IEEE-488.2 and SCPI compatible	
GPIB Function Codes	SH1, AH1, T6, L4, SR1, RL1, PP0, DC1,DT1, C0, E2	
GENERAL		
Memory	Non volatile, stores up to 99 complete panel settings. Last user setup also retained at power down	
Power Requirements	100-240 V, $\pm 10\%$, 48-66 Hz, 50 VA maximum	
Dimensions WxHxD	8.4 x 11.8 x 3.5 inches (213 x 300 x 88 mm)	
Net Weight	Approx. 3 kg	
EMC	Conforms to EN55011 class B for radiated and conducted emissions	
Electrical Discharge Immunity	Conforms to EN55082	
Safety Specifications	Conforms to EN61010, CE Approved	
Operating Temperature	32 °F to 122 °F (0 °C to 50 °C)	
Storage Temperature	-4 °F to 140 °F (-20 °C to 60 °C)	
Humidity	90% RH at 32 °F to 86 °F (0 °C to 30 °C)	

Section 2 Installation

2.1 Introduction

This section contains installation information, power requirements, initial inspection and signal connections for Model 4033 and 4034.

2.2 Mechanical Inspection

This instrument was carefully inspected before shipment. Upon receipt inspect the instrument for damage that might have occurred in transit. If there is damage due to shipping, file a claim with the carrier who transported the unit. The shipping and packing material should be saved if reshipment is required. If the original container is not to be used, then use a heavy carton box. Wrap the unit with plastic and place cardboard strips across the face for protection. Use packing material around all sides of the container and seal it with tape bands. Mark the box "FRAGILE".

2.3 Initial Inspection

After the mechanical inspection, verify the contents of the shipment (accessories). If the contents are incomplete, or if the instrument does not pass the specification acceptance tests, notify the local service center. The unit is calibrated and ready for use upon receipt. For a detailed performance check procedure, please see section 5 of the manual.

2.4 Instrument Mounting

The model 4033 and 4034 programmable pulse generators are intended for bench use. The instrument includes a front feet tilt mechanism for optimum panel viewing angle. The instrument does not require special cooling when operated within conventional temperature limits. The unit can be installed in a closed rack or test station if proper air flow is assured. A 5 cm minimum clearance must be provided at the rear of the unit for proper convection cooling.

2.5 Product Dimensions



2.6 Power Requirements

The model 4033 and 4034 can be operated from any source of 100-240V +/-10% AC, at a frequency from 48Hz to 66Hz. The maximum power consumption is 50 VA.

WARNING

THE LINE POWER VOLTAGE OF THE INSTRUMENT IS NOTED ON THE AC INPUT PLUG. TO PREVENT DAMAGE TO THE INSTRUMENT, CHECK FOR PROPER MATCH OF LINE VOLTAGE AND PROPER FUSE TYPE AND RATING.

The instrument power fuse is located in the AC input plug. To access the fuse, first disconnect the power cord and then remove the fuse cartridge. Use T1A 250V fuse only, as labeled in the rear panel of the unit.

2.7 Grounding Requirements

For the safety of operating personnel, the instrument must be grounded. The central pin on the AC plug grounds the instrument when properly connected to the ground wire and plugged into proper receptacle. The power jack and the mating plug of the supplied power cable meet IEC safety standards.

WARNING

TO AVOID PERSONAL INJURY DUE TO SHOCK, THE THIRD WIRE EARTH GROUND MUST BE CONTINUOUS TO THE POWER OUTLET. BEFORE CONNECTION TO THE POWER OUTLET, EXAMINE ALL CABLES AND CONNECTIONS BETWEEN THE UNIT AND THE FACILITY POWER FOR A CONTINUOUS EARTH GROUND PATH. THE POWER CABLE MUST MEET IEC SAFETY STANDARDS.

2.8 Signal Connections

Use RG58U 50 Ω or equivalent coaxial cables for all input and output signals to and from the instrument. Below specifies the BNC connectors on the instrument:

OUTPUT – Up to 10 Vpp into 50 Ω impedance (20 Vpp into open circuit). The instrument is protected from short circuit to ground.

TRIG IN – 10 k Ω impedance, selectable positive or negative slope, variable level from – 10 V to + 10 V. Input protected to ± 15 V.

SYNC OUT – A positive pulse signal in phase with the main output. TTL levels with a 50 Ω source impedance and with 3.5 ns typical transition times.

2.8.1 Maintaining Pulse Fidelity

Due to the extremely fast pulse rise times obtained from the instrument, special consideration must be given to preserve pulse fidelity. Even at low repetition rates, high frequency components are present in the output waveform. Use high quality coaxial cables, attenuators and terminations.

Note: RG 58 type coaxial cable and typical BNC connectors exhibit impedance tolerances which may cause visible reflections. For maximum fidelity, use short, high quality, 50 Ω coaxial cables.

When signal comparison measurements or time difference determinations are made, the two signals from the test device should travel through coaxial cables with identical loss and time delay characteristics.

When making connections that are not in a 50 Ω environment, keep all lead lengths short, 1/4 inch or less.

2.8.2 Impedance Matching

A mismatch, or different impedance in a transmission line, generates a reflection back along the line to the source. The amplitude and polarity of the reflection are determined by the load impedance in relation to the characteristic impedance of the cable. If the load impedance is higher than the characteristic impedance of the line, the reflection will be of the same polarity as the applied signal. If it is lower, the reflection will be of opposite polarity. These reflections add or subtract from the amplitude of the incident pulse causing distortion and irregular pulse shapes.

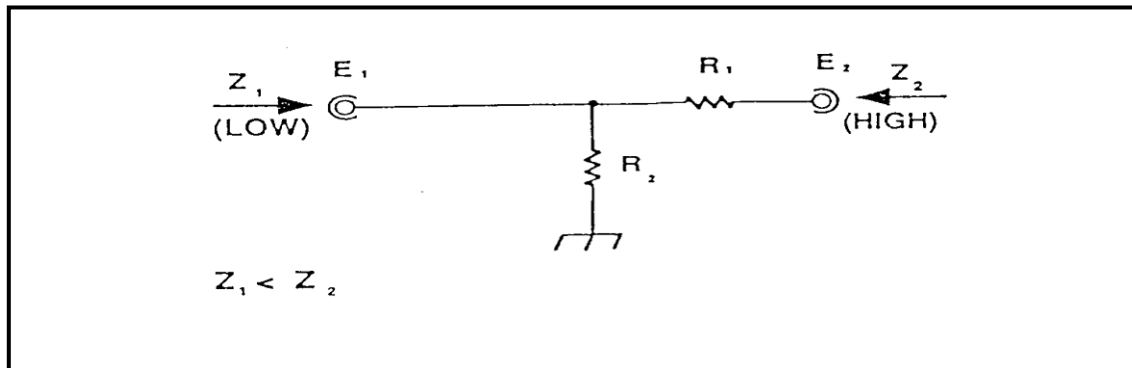

Impedance-matching network that provides minimum attenuation

A simple resistive minimum attenuation impedance matching network that can be used to match the instrument output into relatively low impedance is shown in the above figure. To match impedance with the illustrated network, the following conditions must exist:

$$\frac{(R1 + Z2)R2}{R1 + Z2 + R2} = Z1$$

and

$$R1 + \frac{R1 + Z1R2}{Z1 + R2}$$

Therefore:

$$R1 R2 = Z1 Z2, \text{ and } R1 Z1 = R2 (Z2 - Z1)$$

or

$$R1 = \sqrt{Z2(Z2 - Z1)}$$

and

$$R2 = Z1 \sqrt{\frac{Z2}{Z2 - Z1}}$$

For example: to match a 50Ω system to a 125Ω system, Z1 equals 50Ω and Z2 equals 125Ω

Therefore:

$$R1 = \sqrt{125(125 - 50)} = 96.8 \Omega$$

and

$$R2 = 50 \sqrt{\frac{125}{125 - 50}} = 64.6 \Omega$$

Although the illustrated network provides minimum attenuation, for a purely resistive impedance-matching device, the attenuation as seen from one end does not equal that seen from the other end. A signal (E1) applied from the lower impedance source, encounters a voltage attenuation (A1) which is greater than 1 and less than 2, as follows:

$$A1 = \frac{E1}{E2} = \frac{R1}{Z2} + 1$$

A signal (E2) applied from the higher impedance source (Z2) encounters a greater voltage attenuation (A2), which is greater than 1 and less than 2 (Z2/Z1):

$$A2 = \frac{E2}{E1} = \frac{R1}{R2} + \frac{R1}{Z1} + 1$$

In the example of matching 50Ω to 125Ω,

$$A1 = \frac{96.8}{125} + 1 = 1.77$$

and

$$A2 = \frac{96.8}{64.6} + \frac{96.8}{50} + 1 = 4.43$$

The illustrated network can be modified to provide different attenuation ratios by adding another resistor (less than R1) between Z1 and the junction of R1 and R2.

When constructing such a device, the environment surrounding the components should also be designed to provide smooth transition between the impedances. Acceptable performance can be obtained with discrete components using short lead lengths; however, a full coaxial environment is preferred.

The characteristic impedance of a coaxial device is determined by the ratio between the outside diameter of the inner conductor to the inside diameter of the outer conductor expressed as:

$$Z_0 = \frac{138}{\sqrt{\epsilon}} \log_{10} \frac{D}{d}$$

2.8.3 Rise Time Measurements in Linear Systems

Consider the rise time and fall time of associated equipment when measuring the rise time or fall time of a linear device. If the rise time of the device under test is at least ten times slower than the combined rise times of the instrument, the monitoring oscilloscope, and associated cables, the error introduced will not exceed 1%, and usually may be ignored. If the rise time or fall time of the test device is less than ten times slower than the combined rise times of the testing system, determine the actual rise time of the device under test by using the following formula:

$$R_t = \sqrt{(R_{t1})^2 + (R_{t2})^2 + (R_{t3})^2 + \dots}$$

R_t equals the overall rise time or fall time of the entire measurement system and R₁, R₂, R₃, etc. are the rise times or fall times of the individual components in the system.

2.9 RS-232 Connection

The rear panel RS-232 connector is a standard DB-9 male connector configured as a DCE. The pin assignments are defined in the table below:

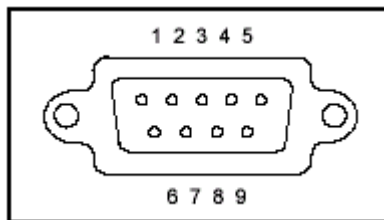

DB-9 pin	Name	Note
----------	------	------

1	-	-
2	TXD	Transmit Data
3	RXD	Receive Data
4	-	-
5	GND	Signal ground
6	-	-
7	RTS	Request to Send
8	CRS	Clear to send
9	-	-

**Note: Use a Null-modem or cross over cable (pin 2 and 3 switched) in order to communicate with instrument.*

2.10 RS-232 Configuration

The instrument use **8 data bits, 1 stop bit, no parity** and baud rate selectable from 2400 to 115K (2400, 4800, 9600, 19200, 38400, 57600, 115200). By default, the instrument is set at **19200-8-N-1**.

Note: If 115K baudrate speed is used, ensure that the RS232 cable is short and can support this speed. Otherwise, there may be some instability and intermittent data transmission failure between the interfacing computer and the instrument.

2.11 GPIB Address

The address can be changed from the front panel by using the "UTILITY" menu.

2.12 GPIB Connections

The rear panel GPIB connector is an AMPHENOL 57-10240 or equivalent, and connects to a standard IEEE-488 bus cable connector. The GPIB line screens are not isolated from chassis and signal ground.

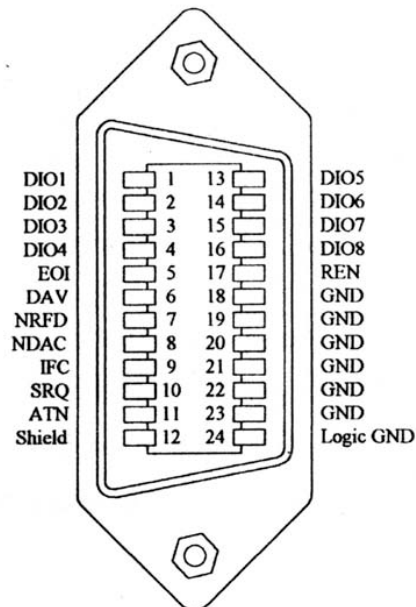

Section 3 Operating Instructions

3.1 General Description

This section describes the displays, controls and connectors of the Model 4033 and 4034 - Pulse Generators. All controls for the instrument local operation are located on the front panel. The connectors are located on both front and rear panels.

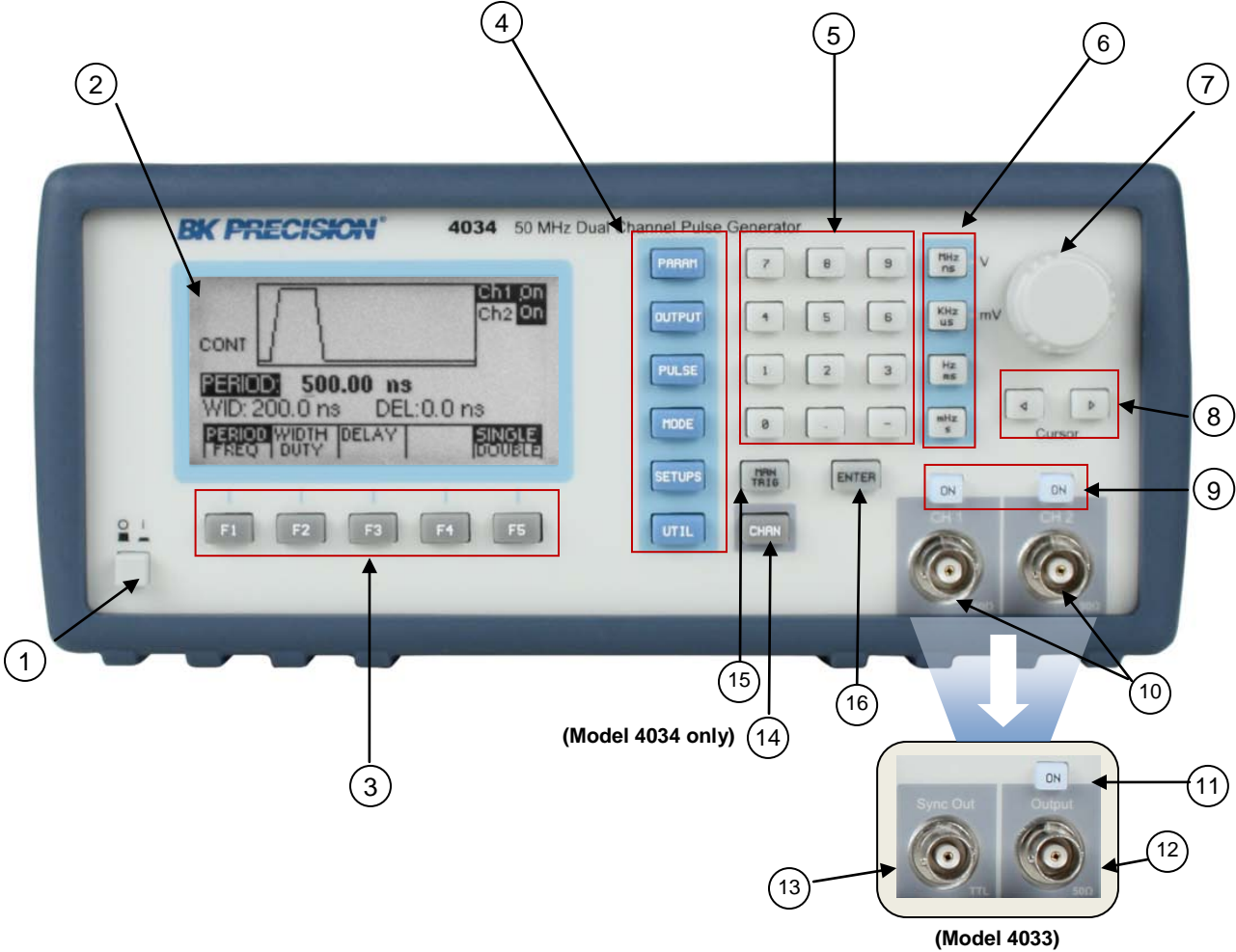

Figure 3.1 - Front Panel View

- | | |
|---|--|
| <ul style="list-style-type: none"> 1. Power ON-OFF 2. Display Window 3. F1-F5 Keys 4. Menu Keys | <ul style="list-style-type: none"> - Applies and removes AC power to the unit - Displays all instrument data and settings on a LCD. - Select the menu options that appear on the bottom section of the LCD display. - Select menu options for waveform parameters (PARAM), output levels (OUTPUT), pulse edges (PULSE), triggering modes (MODE), setup |
|---|--|

- configurations (SETUP), and utility options (UTIL).
5. **Numerical Keypad** - Numeric entry keys for entering values for various functions and modes
 6. **Unit Setting Keys** - Quick keys for setting units for frequency, time, and amplitude
 7. **Rotary Knob** - Used to increment/decrement numerical values or to scan through the possible selections.
 8. **Cursor Keys** - Used to move the cursor (when visible) to either left or right when modifying values of various parameters.
 9. **Output ON** - Controls the main output signal. In model 4033, the output status is ON when display shows “Out On” and the button lights up. In Model 4034, display will show “On” next to “ch1” and/or “ch2” indicators depending on which channel is selected to be on.
 10. **Channel Output** - (model 4034) Dual BNC independent channel outputs (50 Ω) of pulse signal.
 11. **Output ON** - (model 4033) Controls the main output signal. The output status is ON when illuminated.
 12. **Channel Output** - (model 4033) BNC channel output (50 Ω).
 13. **Sync Out** - (model 4033) Sync output, 50 Ω 5V TTL level. Sync out for dual channel model 4034 is located in the rear panel of the instrument.
 14. **CHAN Key** - (model 4034 only) Channel select key
 15. **MAN TRIG Key** - Sends manual trigger pulse when pushed (requires instrument to be in manual trigger mode)
 16. **ENTER Key** - Used for confirming parameter adjustments and settings.

3.2 Display Window

The pulse generator has a graphical LCD display that can display up to 160 x 80 dots. When you power-on the unit a parameter (Frequency) and its current settings appear in the display. The bottom displays a menu that corresponds to the function, parameter or mode display selected.

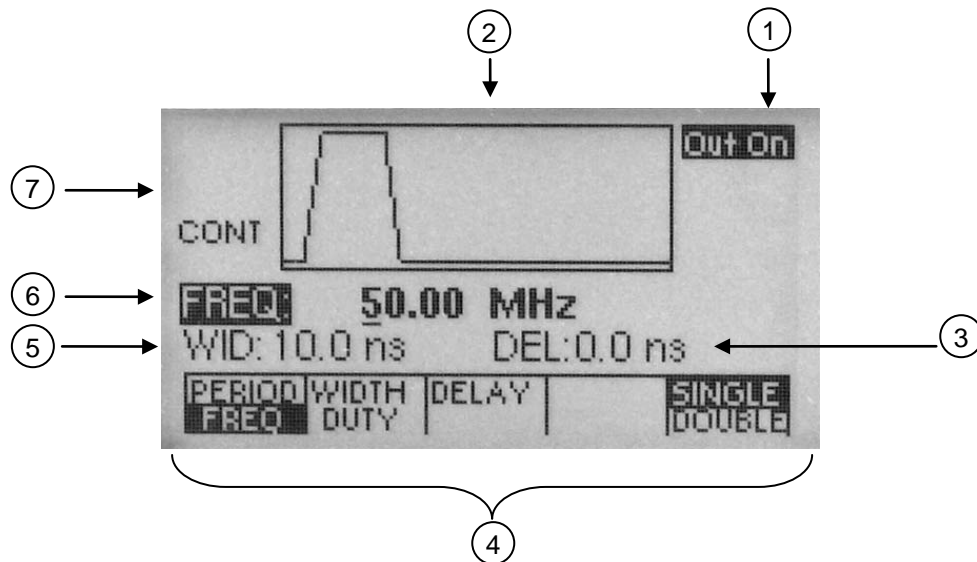

Figure 3.2 - LCD Display Screen

1. **Channel/Output Display**
Displays the current selected channel (when highlighted). (For model 4034 only). Also displays highlighted text “Out On” when output is ON (For model 4033) or displays a highlighted text “On” next to “Ch 1” and/or “Ch 2” when either or both channel outputs are ON (For model 4034).
2. **General Waveform Display**

Displays the general waveform being generated in the channel.

Note: Waveform shown is approximated and scaled down. It does not show the exact representation of the waveform at the output.

3. **DEL Mode Display**
Displays delay setting of the pulse. Alternatively, it can also display other parameters in other menu items.
4. **Menu Functions Display**
Displays the menu options available. Use F1-F5 keys on front panel to select the options.
5. **Secondary Parameter Display**
Displays the values of parameters selected in the menu.
Depending on the options chosen, various parameters will display with a cursor for adjusting their values.
For example, width or duty cycle can be displayed.
6. **Main Parameter Display**
Displays the main parameter value. When highlighted, it can be adjusted with numeric keypad or rotary knob. It can, for example, adjust frequency or period.
7. **Mode Display**
Displays the current mode of the generator. This can be the trigger mode of the power supply.

3.3 Front Panel Controls

The front-panel controls select, display, and change parameter, function, and mode settings. Use the rotary input knob and the cursor movement keys to enter data into the pulse generator.

To change a setting:

1. Press the key that leads to a required item.
2. Move cursor using cursor keys to the appropriate position in the numeric field.
3. Use the rotary input or the numerical keyboard to change the value of the displayed item. Changes take effect immediately.

The following subsections describe the function of each front panel key and connector.

3.4 Back Panel Controls

The pulse generator has 4 BNC Connectors on the rear panel where you can connect coaxial cables. These coaxial connectors are labeled accordingly and serve as carrier lines for input and output signals delivered to and from the pulse generator.

Model 4033

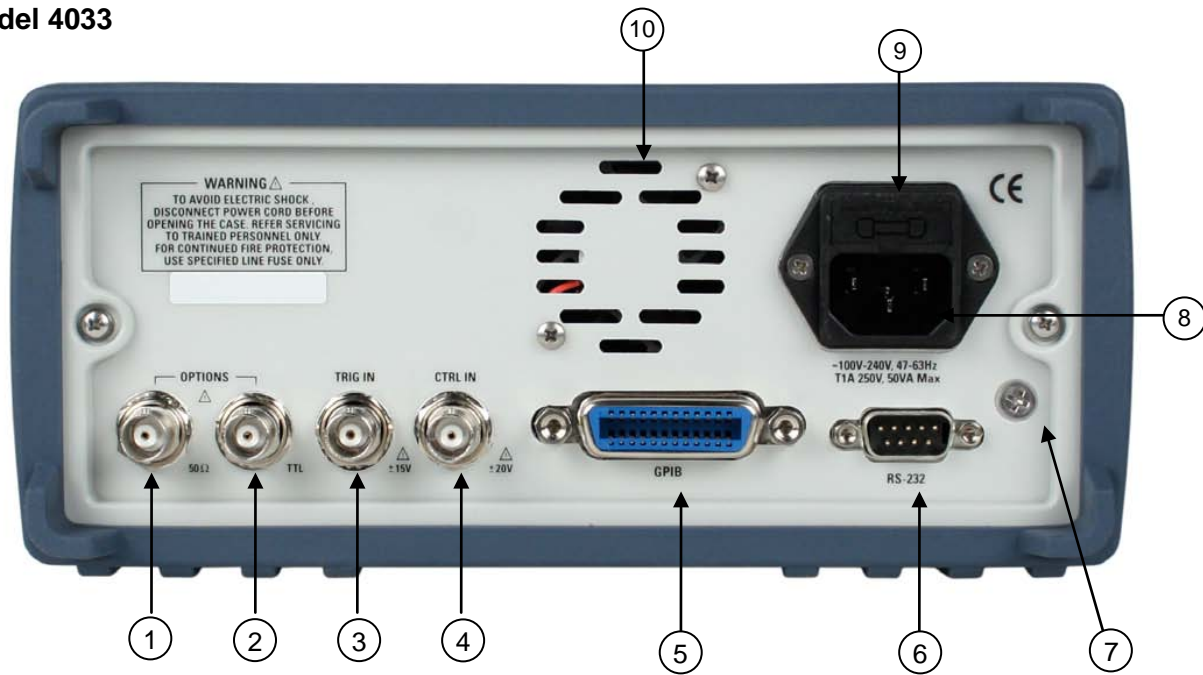

Model 4034

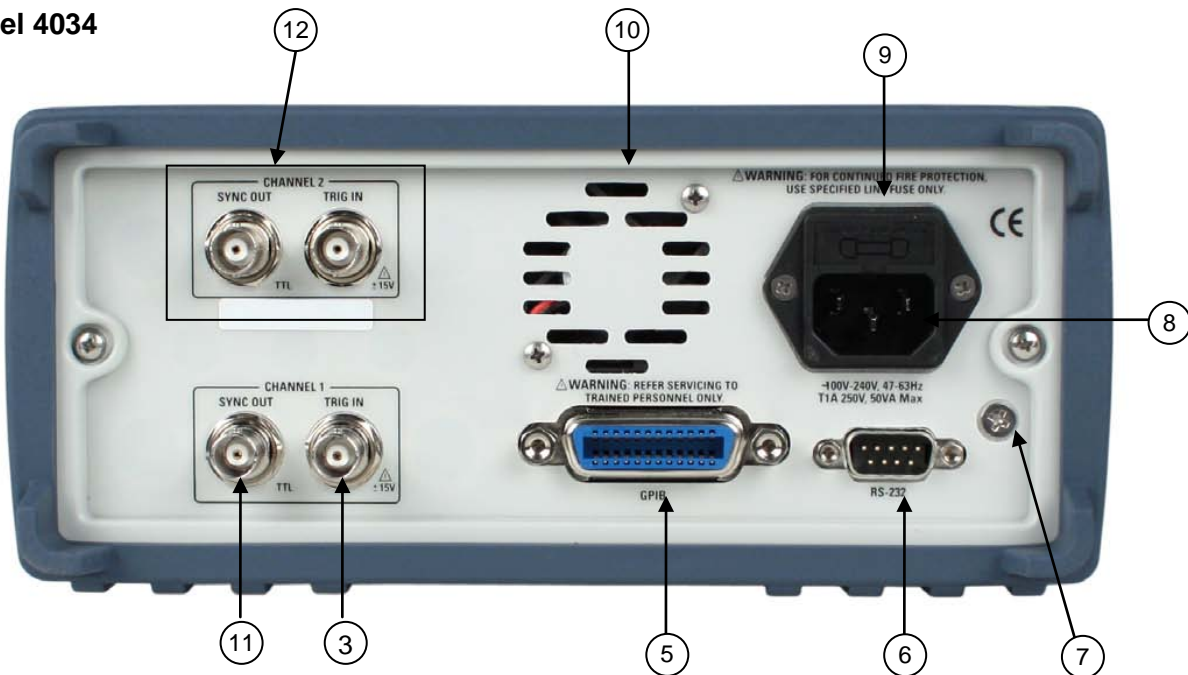

Figure 3.3 - Back Panel View

1. **Options 50 Ω** - Reserved for future use.
2. **Options TTL** - Reserved for future use.
3. **Trig In** - Use this connector to apply an external trigger or gate signal, depending on the waveform generator setting, to the generator. Maximum input is ± 15 V.
4. **CTRL IN** - Not used
5. **GPIB Interface** - Use to interface with a computer via GPIB for remote communication.

-
6. **RS-232 Interface** - This is a standard RS-232 port used for remote interface. Null modem or cross serial cable is required to communicate with a PC via this port.
 7. **Earth GND** - This screw is the earth ground that is tied to the chassis.
 8. **AC Power Connector** - Used to connect power cable to AC line source.
 9. **Fuse Box** - Fuse compartment. For replacement, use T1A, 250V fuse only.
 10. **Cooling Fan** - To ensure proper cooling, please leave room between the fan output and other objects with at least one foot distance.
 11. **SYNC OUT** - (Model 4034 only). 50 Ω TTL sync output for channel 1.
 12. **TRIG IN and SYNC OUT** - (Model 4034 only). TRIG IN and SYNC OUT BNC connectors for channel 2. SYNC OUT is a 50 Ω TTL level signal. TRIG IN accepts maximum ± 15 V.

3.5 Output connectors

The pulse generator output circuits operate as a 50 Ω voltage source working into a 50 Ω load. At higher frequencies, un-terminated or improperly terminated output cause aberrations on the output waveform. In addition, loads less than 50 Ω reduce the waveform amplitude, while loads more than 50 Ω increase waveform amplitude.

Excessive distortion or aberrations caused by improper termination are less noticeable at lower frequencies.

To ensure pulse integrity, follow these precautions:

1. Use good quality 50 Ω coaxial cable and connectors.
2. Make all connections tight and as short as possible.
3. Use good quality attenuators if it is necessary to reduce pulse amplitudes applied to sensitive circuits.
4. Use termination or impedance-matching devices to avoid reflections.
5. Ensure that attenuators and terminations have adequate power handling capabilities.

If there is a DC voltage across the output load, use a coupling capacitor in series with the load. The time constant of the coupling capacitor and load must be long enough to maintain pulse flatness.

Impedance Matching

If the waveform generator is driving a high impedance, such as the 1 M Ω input impedance (paralleled by a stated capacitance) of an oscilloscope vertical input, connect the transmission line to a 50 Ω attenuator, a 50 Ω termination and to the oscilloscope input. The attenuator isolates the input capacitance of the device and terminates the waveform generator properly.

3.6 MENU Keys

These keys select the main menus for displaying or changing a parameter, function or mode. Below is the hierarchy and selections of the menu tree.

MENU TREE

- PARAM
 - o PERIOD | FREQ
 - o WIDTH | DUTY
 - o DELAY
 - o INDEP | CH1 (When CH2 is selected only)
 - o SINGLE | DOUBLE
- OUTPUT
 - o HILVL
 - o LOLVL
 - o PREDEF
 - ECL

- TTL
 - CMOS
 - USER
 - HIPRED | LOPRED
 - OUTPUT LIMITS
 - LIM OF
 - LIM ON
 - HILIM
 - LOLIM
 - PREV
- PULSE
 - RISE
 - FALL
 - EQUAL
 - NORM | COMPL
- MODE
 - CONT
 - TRIG
 - MAN (Manual Trigger)
 - INT (Internal Trigger Rate)
 - EXT (External Trigger)
 - PREV
 - GATE
 - MAN (Manual Gate Trigger)
 - INT (Internal Gate Trigger Rate)
 - EXT (External Gate Trigger)
 - PREV
 - BURST
 - MAN (Manual Burst)
 - INT (Internal Burst Rate)
 - EXT (Burst External)
 - NBRST (Number of Bursts)
 - PREV
 - EXTWID
- SETUPS
 - RECALL
 - STORE
 - CLEAR ALL
- UTIL
 - GPIB (ACTIVE) (GPIB Address)
 - RS232 (ACTIVE) (Baudrate)
 - INTEN
 - POWER (Power On Setup)

3.6.1 PARAMETER Menu

This key selects and displays the waveform frequency, amplitude, offset and external reference and allows changing the parameter data.

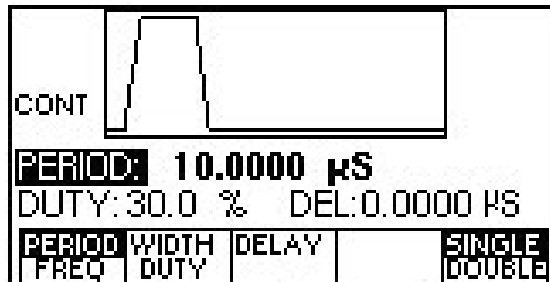

Frequency Menu

- F1: PERIOD/FREQ** - Selects and displays the period or the pulse frequency. Change the values using the cursor keys, rotary knob or numerical keys. If a certain setting can't produce the waveform at the desired parameters, the generator displays an error message. While the

pulse mode is set to external width on, the value of the period may be changed but the value is not displayed, since the actual value of the period is set by the external pulse

F2: WIDTH/DUTY

- Selects and displays the pulse width and duty cycle. The minimum value of the width is 10ns, with the maximum value dependent on the values of the period, delay and transition times. The **Duty Cycle** is defined as the ratio of the pulse width to the pulse period. Changing the duty cycle will therefore change the width accordingly. The duty cycle has both a value and a state (on or off). On Power On the duty cycle is off. This means that the width is determined by the width parameter only. The duty cycle is set to ON by entering a value. The value may then be changed using the rotary encoder or the numeric keys. When the duty cycle is on, changing the period will cause a change in the width such that the duty cycle is kept constant. The duty cycle is set to OFF by changing the width value. The instrument will store the last value of the duty cycle, and set the duty cycle to this value when it is next set to ON. The duty cycle has an absolute range of 1 % to 99 %, but the actual value is limited by the values of the period, delay and transition times.

F3: DELAY

- This parameter is used in two instances. The first is to set the delay of the pulse in the single pulse mode. The delay governs the time from the SYNC signal to the start of the pulse. The second instance is the double pulse mode. Here the delay governs the time from the SYNC pulse to the beginning of the second pulse. The minimum and maximum values of the delay are dependent on the values of the period, width and leading and trailing edge times. The delay range is 0 to 9.80000 s.

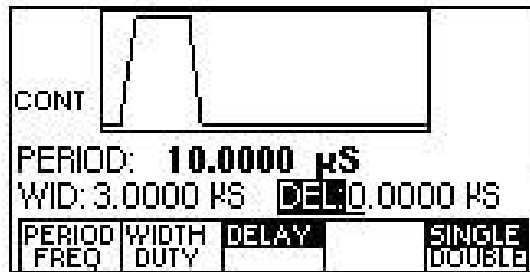

Delay Menu

F4: INDEP/CH1

- When channel 2 is selected using the CHAN button, this menu option will appear. By default, it is selected in INDEP, which makes channel 2 an independent channel. If CH1 is selected, channel 2 and channel 1 will have matching clock and trigger. The period and frequency will also be the same as channel 1. In this mode, all triggering options will not be available in the MODE menu, as it will be dependent on channel 1 settings. Frequency and Period adjust options will also be disabled. Aside from these, all other parameters are still adjustable.

F5: SINGLE/DOUBLE

- The unit can be set to generate either a SINGLE pulse or a DOUBLE pulse. In the double pulse mode, the first pulse is generated without delay from the start and the second pulse is generated after a delay, from the start of the period, as determined by the DELAY parameter. Thus, in order to generate a double pulse, the delay must first be set, and then the double pulse may be set on. The double pulse mode state is toggled using the F5 key. The minimum and maximum values of the delay are dependent on the values of the period, width, delay and transition parameters.

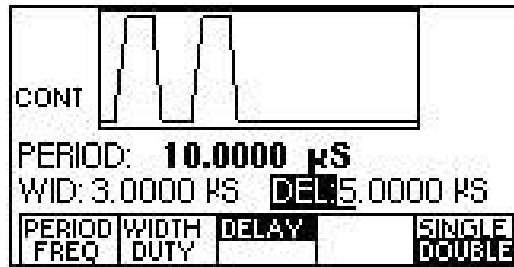

Double Pulse

3.6.2 OUTPUT Menu

The Output menu enables the pulse high and low levels to be set. The levels are limited by four factors:

- The absolute limits are ± 10 V.
- The high level must be greater than the low level.
- The pulse amplitude must be between 0.1 V and 10 V p-p, into 50 Ω .
- The levels cannot exceed the limits as set in the OUTPUT LIMITS menu.

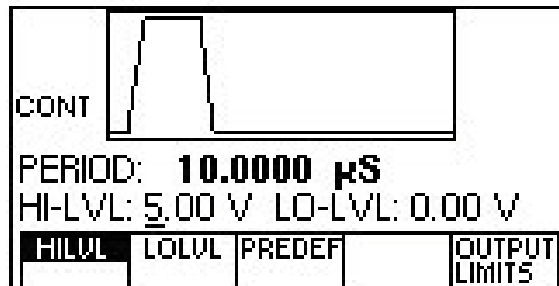

Output Menu

- F1: HILVL** - Selects the pulse high level voltage.
- F2: LOLVL** - Selects the pulse low level voltage.
- F3: PREDEF** - Selects predefined pulse output levels. In addition to being able to set the levels to any value within the limits, the user may also select one of four pre-defined levels:

CMOS: Low level (LOLVL) = 0 V, High level (HILVL) = 5 V

TTL: Low level (LOLVL) = 0.4 V, High level (HILVL) = 2.4 V

ECL: Low level (LOLVL) = -1.8 V, High level (HILVL) = -0.8 V

USER: User-defined levels, entered by using the USER menu (F5: HIPRED and LOPRED) Press OUTPUT to exit USER menu.

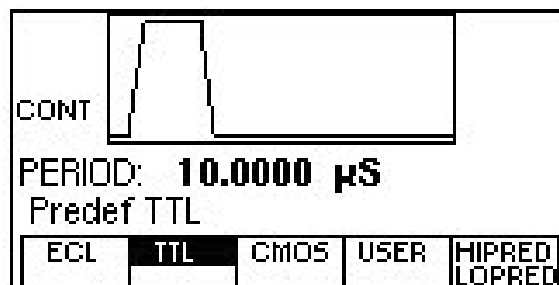

Predefined Output Menu

F5: OUTPUT LIMITS - Allows entering limits for the output levels to protect external devices connected to the unit output.

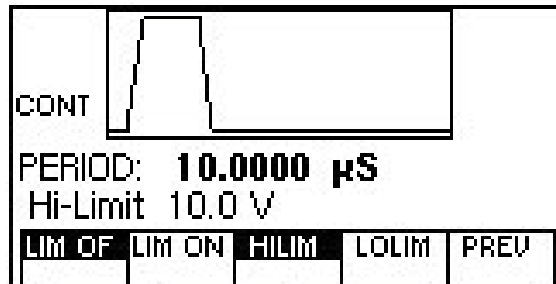

Output Limits Menu

- F1: LIM OF** – Turns off limit level protection
- F2: LIM ON** – Turns on limit level protection
- F3: HILIM** – Sets high limit for protection
- F4: LOLIM** – Sets low limit for protection
- F5: PREV** – Returns to previous menu level

3.6.3 PULSE Menu

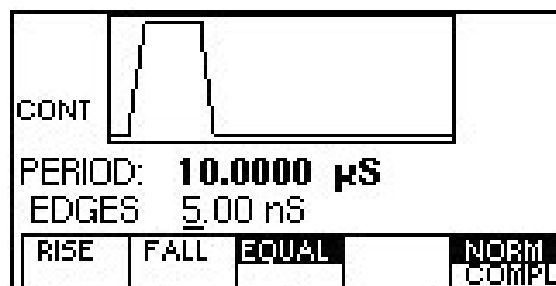

Pulse Menu

- F1: RISE** - Selects the pulse Rise time (Leading edge).
- F2: FALL** - Selects the pulse Fall time (Trailing edge).
- F3: EQUAL** - Selects equal Rise (Leading edge) and Fall (Trailing edge) times.
- F5: NORMAL/COMPL** - Selects Normal or Complement pulse mode.

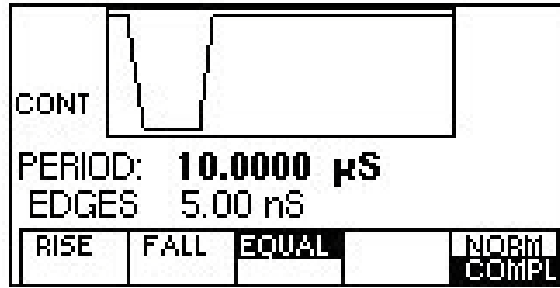

Complement Pulse Mode

The transition time range is 5 ns to 100 ms, but the value is limited to a 20:1 ratio between the transition times. In addition, both values must be within one of the following ranges:

- 5 ns – 100 ns
- 50 ns – 1 μs
- 500 ns – 10 μs
- 5 μs – 100 μs
- 50 μs – 1 ms
- 500 μs – 10 ms
- 5 ms – 100 ms

The transition times are also limited by the values of the period, width and delay.

3.6.4 MODE Menu

Selects the output trigger mode: CONT (Continuous), TRIG (Triggered), GATE (Gated), BRST (Burst) and EXTWID (External pulse).

To select the output mode, press MODE, then press the function key that corresponds to the desired Mode menu option, as shown:

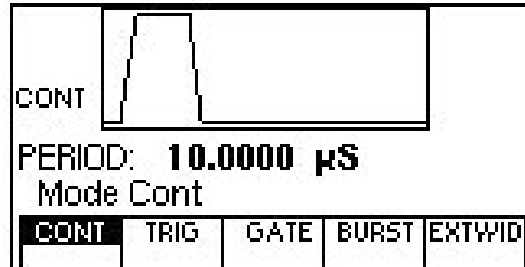

Mode Menu

F1: CONT - (Continuous) - Selects continuous output.

F2: TRIG - (Triggered) – Triggers one output cycle of the selected pulse for each trigger event.

F3: GATE - (Gated) - Triggers output cycles as long as the trigger source asserts the gate signal.

F4: BRST - (Burst) - Triggers output N output cycles for each trigger event, where N ranges from 2 to 999,999.

F5: EXTWID - In the external width (EXT WID) pulse mode, the pulse period and width are determined by the externally applied signal. The pulse generator then applies transition and level parameters to this signal in order to generate the pulse. The period, width and delay may be changed, but their change has no effect on the pulse, and their values are not displayed. The trigger mode may not be changed while the external width pulse mode is enabled.

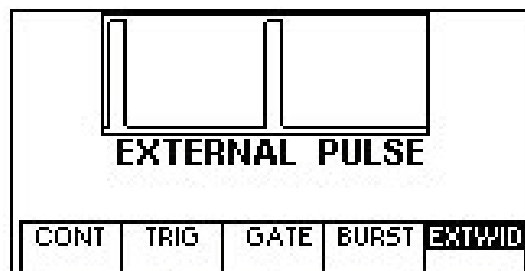

External Pulse

After selecting the TRIG , GATE or BURST menu, the trigger source menu is available:

For TRIG and GATE mode:

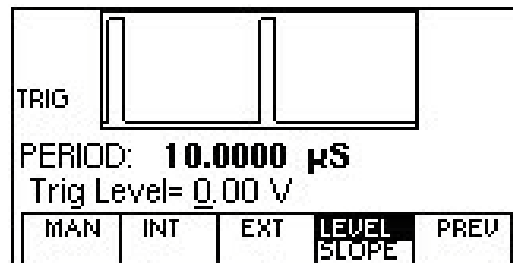

Trigger Menu

F1: MAN - Selects manual as the trigger source. Pressing the MAN TRIG key generates the trigger. In the Gate trigger mode, the pulse is generated as long as the key is being pressed.

F2: INT - Selects the internal trigger generator as the trigger source. Change the internal trigger rate displayed with the rotary input knob or numerical keys. The rate has a range of 100 ns to 99.99 s, although the minimum value is limited by the value of the period in that the rate cannot be less than the period.

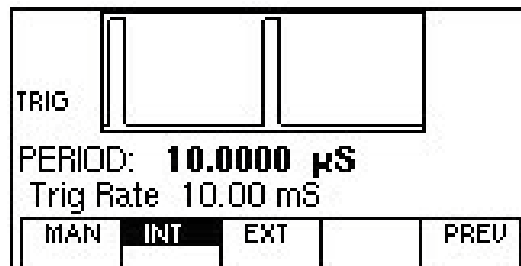

Internal Trigger

F3: EXT - Selects the external trigger signal as the trigger source. The trigger source is supplied through the TRIG IN connector.

F4: LEVEL/SLOPE - Two parameters are related to external trigger source operation. These are LEVEL and SLOPE. The Level determines at what voltage level the external signal will be recognized as a trigger. At level less than this, no pulse will be generated. The Slope determines whether the positive or negative edge of the trigger signal will trigger the pulse. Use the rotary knob to toggle between the two selections.

For Burst Mode:

F1: MAN - Selects manual as the trigger source. Pressing the MAN TRIG key generates the trigger. In the Gate trigger mode, the pulse is generated as long as the key is being pressed.

F2: INT - Selects the internal trigger generator as the trigger source. Change the internal trigger rate displayed with the rotary input knob or numerical keys. The rate has a range of 100 ns to

99.99 s, although the minimum value is limited by the value of the period in that the rate cannot be less than the period.

F3: EXT - Selects the external trigger signal as the trigger source. The trigger source is supplied through the TRIG IN connector.

F4: NBRST - Selects the number of burst cycles to burst. Set from 2 to 999,999 cycles.

F5: LEVEL/SLOPE - Two parameters are related to external trigger source operation. These are LEVEL and SLOPE. The Level determines at what voltage level the external signal will be recognized as a trigger. At level less than this, no pulse will be generated. The Slope determines whether the positive or negative edge of the trigger signal will trigger the pulse. Use the rotary knob to toggle between the two selections.

3.6.5 SETUPS Menu

The pulse generator can store the current front-panel settings and recall them into one of 99 storage buffers. When you recall a setup, the pulse generator restores the front-panel settings to those that you stored in the selected buffer. Because it is impossible to 100% guarantee against loss of stored data, you should maintain a record of the data stored in memory so that you can manually restore such data, if necessary.

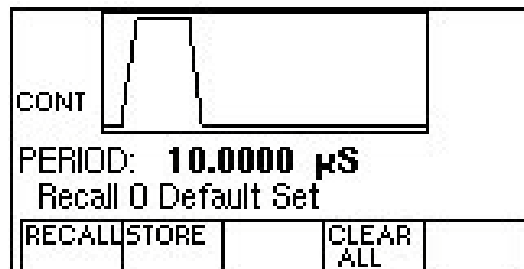

Setups Menu

F1: RECALL - Recalls a previously stored front-panel setup from the selected buffer. Change the buffer number by using the rotary input knob. Valid storage buffer numbers are from 1 to 99.

Buffer 0 is the factory default setup; buffer 100 is the last front panel setup before power-off.

F2: STORE - Stores the current front-panel setup to the specified storage buffer. Change the buffer number by using the data keys or the rotary input knob. Valid storage buffer numbers range from 1 to 99.

F4: CLEAR ALL - Clears all data on all memory settings, after a YES or NO selection message.

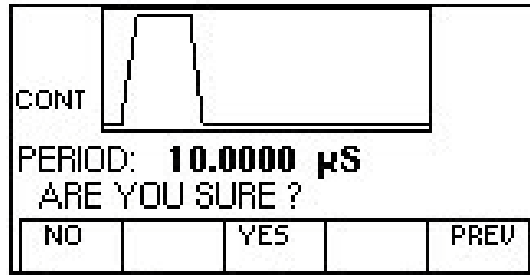

3.6.6 UTILITY Menu

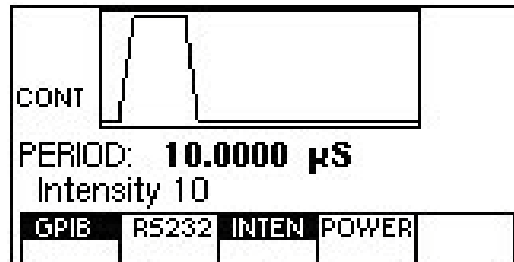

Utility Menu

F1: GPIB

-Selects the GPIB remote mode of operation. After selection the GPIB address can be set to any value from 1 to 31 using the rotary knob. The value is kept in a nonvolatile memory and used at power-on. The factory default address is 10. Setting the address to 31 puts the device in the off-bus state (it will not respond to messages on the GPIB bus).

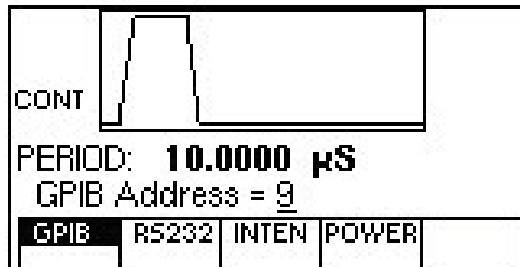

GPIB Menu

F2: RS232

-Selects the RS232 remote control mode. After selection, the baud rate can be selected as 1200, 2400, 9600, 19200, 38400, 57600 or 115K. Always the RS-232 uses 8 bit data, 1 stop bit and no parity.

Note: If 115K baudrate speed is used, ensure that the RS232 cable is short and can support this speed. Otherwise, there may be some instability and intermittent data transmission failure between the interfacing computer and the instrument.

F3: INTEN

- Selects the intensity of the LCD display. Select a value using the rotary input knob. Valid numeric values are from 1 to 31. The value is kept in the nonvolatile memory, after a 20 seconds

time-out.

F4: POWER - (Power-on default) Selects the power-on default setting. Select a value using the data keys or the rotary input knob. The selection is effective after a 20s time-out period. Select zero (0) to have the pulse generator power on with the factory default settings. Select 99 to have the pulse generator power-on with the settings it had at the last power-off. Select any other value in the range from 1 to 98 to have the pulse generator power-on with the settings that you have saved with SETUPS STORE in the range 1 to 99.

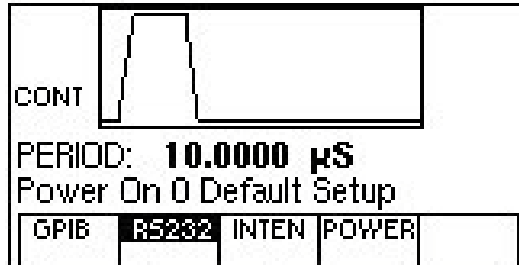

Power-On Menu

NOTE: Power-on settings **cannot** restore the status of output at power-on, meaning if the output is ON, power-on settings cannot recall it to be ON at start up. This setting will always remain OFF and power on, which is same as the default setup indicated above in Table 3-2. Although the output status can be stored into memory for recall using the store/recall functions, it cannot be recalled for a power-on setting start up. This is due to safety concerns as sensitive devices that are connected to the outputs of the generator may accidentally be damaged at power-on if the power-on configurations are not set properly (i.e. Amplitude level set too high for power-on may easily damage a sensitive device by accident).

3.7 ON Key

Use this key to control the main output signal. A build-in LED lights when the output is active.

3.8 Cursor Movement Keys

Use these keys to move the cursor (when visible) either left or right. They are used in conjunction with the rotary input knob to set the step size of the rotary input knob.

3.9 Rotary Input Knob

Use this knob to increase and decrease numeric values or to scroll through a list. The cursor indicates the low-order position of the displayed value which changes when you rotate the knob (for straight numeric entries only). For other types of data, the whole value changes when you rotate the knob.

3.10 Power-On Settings

At power-on, the pulse generator performs a diagnostic self-test procedure to check itself for errors. When the pulse generator finishes the diagnostic self-test routine, it enters the local state (LOGS) and assumes power-on default settings if the POWER-ON setting is at 0. You can program the pulse generator for any settings you want at power on, as described earlier in this section.

The factory default settings are:

Power-on Default Settings

Key Functions	Values	Comments
PERIOD	500 ns	Pulse Period
WIDTH	200 ns	Pulse Width
DELAY	0 ns	Pulse delay from Sync out
DPDELAY	5 us	Delay between pulses in double pulse mode
HILVL	2.5 V	Pulse high level
LOLVL	-2.5 V	Pulse low level
MODE	CONT	Pulse mode
N-BURST	2	Waves per burst
SLOPE	POS	Positive external trigger slope
TLVL	1 V	External trigger level
TRIG SOURCE	MAN	Trigger source
INT TRG RATE	1 ms	Internal trigger rate
OUPTUT	OFF	Output disabled
PULSE MODE	Normal	Normal single pulse output
MODULATION	OFF	Modulation execution
RISE	5 ns	Pulse rise time
FALL	5 ns	Pulse fall time

Table 3-2

NOTE: Power-on settings cannot restore the status of output at power-on, meaning if the output is ON, power-on settings cannot recall it to be ON at start up. This setting will always remain OFF and power on, which is same as the default setup indicated above in Table 3-2. Although the output status can be stored into memory for recall using the store/recall functions, it cannot be recalled for a power-on setting start up. This is due to safety concerns as sensitive devices that are connected to the outputs of the generator may accidentally be damaged at power-on if the power-on configurations are not set properly (i.e. Amplitude level set too high for power-on may easily damage a sensitive device by accident).

3.11 Memory

The pulse generator uses a non-volatile FLASH memory for storing front panel settings. Up to 100 front panel settings can be stored.

3.12 Displaying Errors

At power-on, the waveform generator performs a diagnostic routine to check itself for problems. If the diagnostic routine finds an error, an error message is displayed. The waveform generator also displays error messages when front-panel settings are either invalid or may produce unexpected results.

Error messages

Message Text	Cause
Setting conflict	Can't have this parameter set with other parameters.
Trig rate short	Internal trigger rate too short for pulse or burst.
Empty location	Attempt to restore a non-existent setting.
Calibration Error	An error when performing unit calibration – for service personnel only.
LCA load error	Internal hardware error, must re-power the unit
Output overload	An excessive loading of the output stage
Verify unit calibration	At power-on the unit checks for valid calibration data. Need to calibrate the unit.
Incorrect entry	A incorrect value entry or syntax error
Width too high	The width value is too high for the pulse period selected
Set other level	When the pulse amplitude is >10Vp-p, need to change the other pulse level
Save to Flash failed	When saving the instrument settings. Need to save again the setting.
Out of range	Attempt to set a value out of instrument limits or in conflict with other pulse parameters.

3.13 Pulse Definitions

The figures illustrate the various pulse parameter definitions.

Pulse HIGH LEVEL corresponds to the most positive level of the pulse. Pulse LOW LEVEL corresponds to the most negative level of the pulse. Pulse AMPLITUDE is defined as the difference between the HIGH LEVEL and LOW LEVEL values.

Transition time (LEADING or TRAILING EDGE) is the interval required for the pulse to go from 10% to 90% of the selected amplitude or vice versa.

The way in which the instrument defines pulse parameters makes a distinction between the selected pulse, which assumes the fastest transition times and the actual pulse output. The values specified for WIDTH, PERIOD, and DELAY are defined with reference to the point at which the selected pulse reaches 50% of the amplitude during the leading and trailing edges at the fastest transition time.

WIDTH is the time interval between the 50% points of the leading and trailing edges. If the selected leading and trailing edge transition times are equal, the time interval between the 50% points is the same as that between the first and third corners.

PERIOD is the time between the 50% points on the rising edges of two consecutive trigger outputs. DELAY is the time between the 50% points on the rising edge of the TRIG OUTPUT pulse and the 50% point of the leading edge of the output pulse (at fastest transition time).

When VARIABLE TRANSITION TIMES are selected, the time interval between the 50% points of the actual pulse depends on both the WIDTH and TRANSITION TIME settings. A trailing edge slower or faster than the leading edge respectively lengthens or shortens the 50% interval. In effect, the pulse edges pivot about the first and third corners while the interval between these corners remains fixed for a given width setting.

As long as the leading and trailing edge times are equal, the selected width and the actual width are the same.

In the SINGLE or DOUBLE pulse mode the instrument defines PERIOD as the time between the 50% points on the leading edges of two consecutive trigger outputs. DELAY, in double pulse mode, is the time between the leading edges of the first and second pulse using as a reference point 50% amplitude with fastest transition times.

SETTLING TIME is the interval required for the pulse level to enter and remain in the specified level ACCURACY RANGE, measured from the 90% AMPLITUDE point.

3.14 Pulse Parameter Limitations

The following formulas express the limits on Period, Width, and Delay.

Single Pulse per Period Modes

(Un-delayed, Delayed, Counted Burst with single pulse mode)

$[\text{Period} - (\text{Width} + \text{Delay})]$ must be $> 10 \text{ ns}$

$0.99 * \text{Period}$ must be $> (\text{Width} + \text{Delay})$

Pulse max	= 10.00 s
Pulse min	= (Width + Delay + 10 ns), but not less than 20 ns
Width max	= $[(\text{Period} * 0.99) - \text{Delay} - 10 \text{ ns}]$, but not more than 9.89999 s
Width min	= 10 ns
Delay max	= $[(\text{Period} * 0.99) - \text{Width} - 10 \text{ ns}]$, but not more than 9.89998 s
Delay min	= 0

Single Pulse Transition Time Restrictions

Width must be $> 1.3 * \text{Leading Edge}$

$(\text{Period} - \text{Width})$ must be $> 1.3 * \text{Trailing Edge}$

Double Pulse per Period Modes

(Paired Pulse and Counted Burst with Paired pulses)

Delay must be $> \text{Width}$

$0.99 * \text{Delay}$ must be $> (\text{Width} + 10 \text{ ns})$

Pulse max	= 10.00 s
Pulse min	= (Width + Delay + 10 ns), but not less than 40 ns
Width max	= $[(0.99 * \text{Delay}) - 10 \text{ ns}]$, but not $> 4.85000 \text{ s}$
Width min	= 10 ns
Delay max	= $[(\text{Period} * 0.99) - \text{Width} - 10 \text{ ns}]$, but not $> 9.80000 \text{ s}$

Delay min = (Width + 10 ns)

Double Pulse Transition Time Restrictions

- Width must be > 1.3 * Leading Edge
- (Delay - Width) must be > 1.3 * Trailing Edge
- [Period - (Delay + Width)] must be > (1.3 * Trailing Edge)

Internal Trigger Burst Mode

(0.99 * Trig Rate) must be > (Period * Burst Count)

3.15 Pulse Definitions

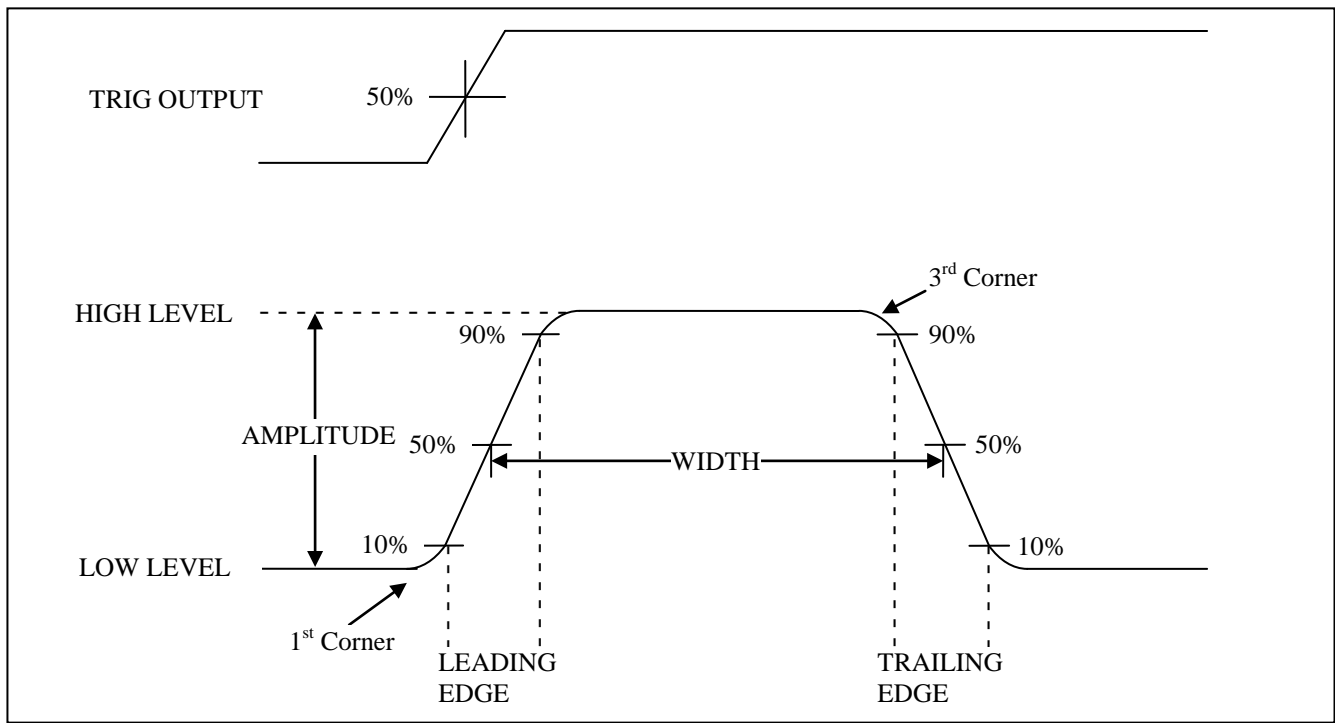

Pulse Definitions – High and Low Levels

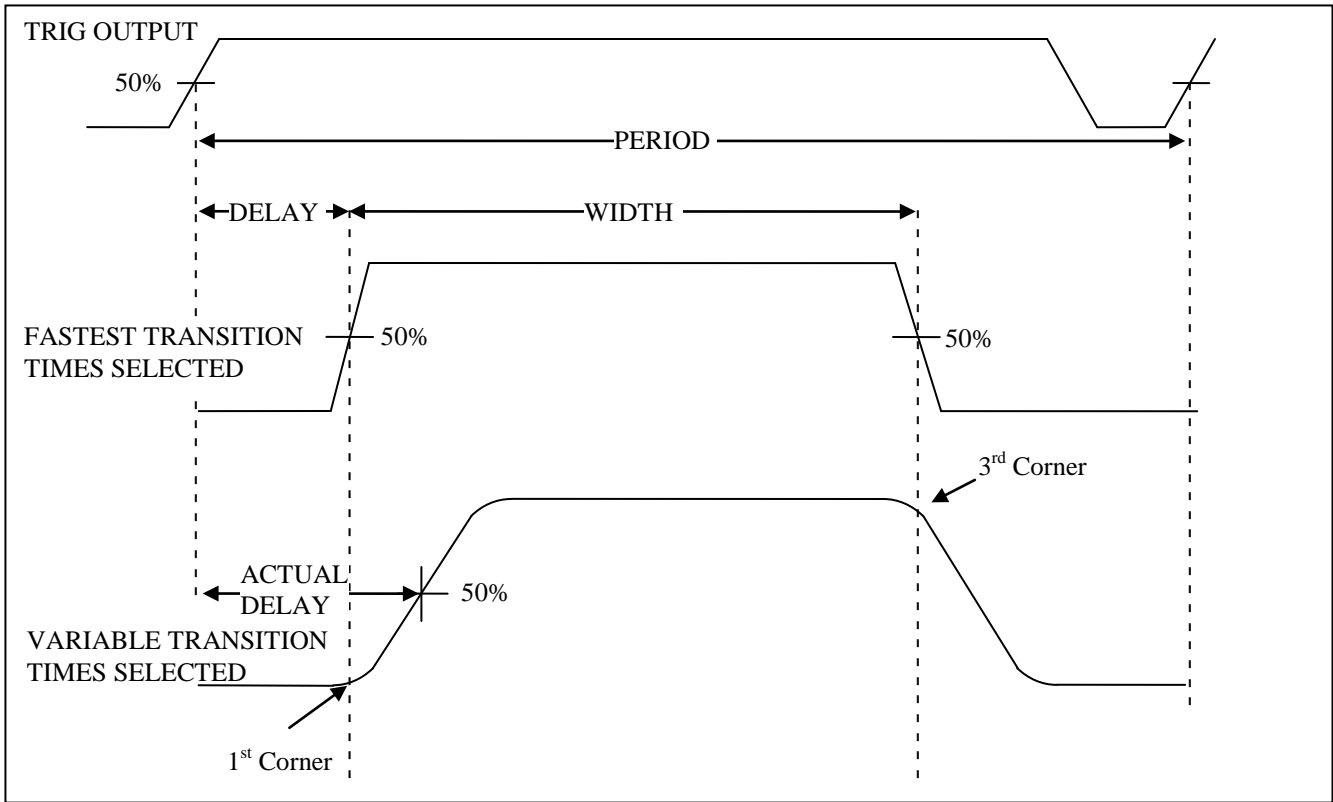

Pulse Definitions – Width, Period, and Delay

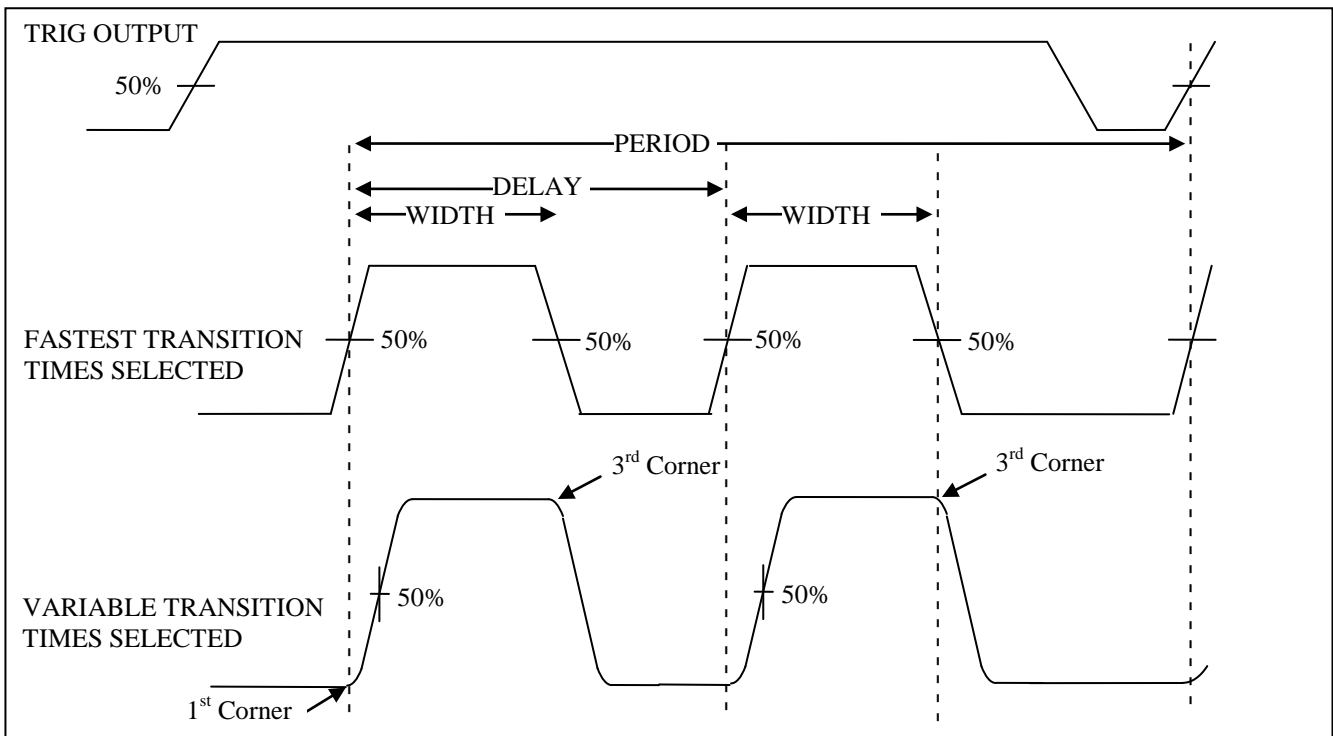

Pulse Definitions – Period and delay – Double Pulse Mode

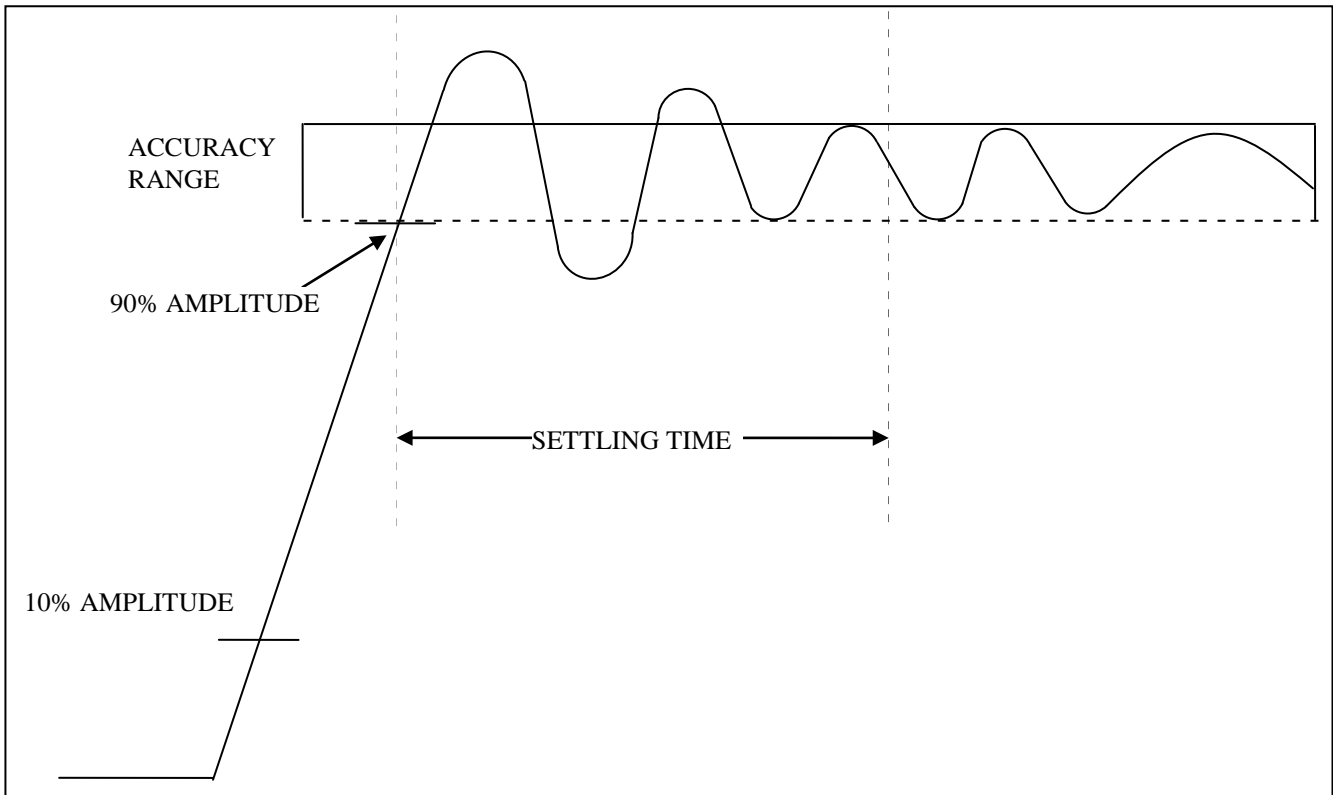

Pulse Definitions – Settling Time

Section 4 Programming

4.1 Overview

4.1.1 GPIB

This section provides detailed information on programming the pulse generator via the IEEE 488 bus (GPIB - General Purpose Interface Bus). The pulse generator is programmable over the IEEE 488 bus, and its message protocol is compatible with IEEE 488.2. The device command set is compatible with the SCPI 1992.0 standard. The SCPI standard does not cover all the needs of the pulse generator, and so the standard has been added where necessary.

The command syntax as defined by the IEEE 488.2 and SCPI standards is briefly explained in the following sections. Users who have experience programming GPIB instruments may skip these paragraphs, and go directly to where the individual command syntax is given. Users wishing to gain further insight should consult the standards.

4.1.2 RS-232-C

Be sure that you have the Remote Mode set to RS-232 and correctly set the baud rate.

EIA standard RS-232-C specifies the electrical characteristics and pin out of a serial communication standard for connecting "data terminal equipment" (DTE) to "data communication equipment" (DCE). Data terminal equipment is usually devices such as terminals, computers, or printers that are the final destination for data. Data communication equipment, on the other hand, is usually a modem or other device that converts the data to another form and passes it through. The instrument can be configured only as a DCE, so in most cases it can be connected with a straight-through cable to a computer, but would require special cabling to connect to another DCE device.

The baud rate is the bit rate during the transmission of a word in bits per second. Different devices use many baud rates, but the baud rates of the two devices that are connected must be the same.

Data signals over the RS-232-C use a voltage of +3V to +25V to represent a zero (called a space) and a voltage of -3V to -25V to represent a one (called a mark). Handshake and control lines use +3V to +25V to indicate a true condition and -3V to -25V to indicate a false condition.

When no data is being transmitted, the idle state of the data lines will be the mark state. To transmit a byte, the transmitting device first sends a start bit to synchronize the receiver.

The RS-232-C standard is not very specific about many of the handshaking signals and it is therefore usually necessary to refer to the manuals for both of the devices being connected to determine the exact pin out, signal definition, and signal direction for the devices.

The serial interface implements the same SCPI command set as the GPIB interface. The instrument is programmed by sending ASCII coded characters to the instrument.

When the instrument is in the remote mode, remote command input has priority over any front panel control. Therefore, as long as the serial interface is continuously supplied with data, the keyboard will appear to be inoperative to the user.

Note: In remote mode, any command sent or received via RS232 will change the display screen with the following:



User can return to local control with the press of any front panel keys, but it is extremely important to note that this should be done ONLY when nothing is being sent or transferred between the instrument and the connected PC. Any interruptions during transfer may delay the communication process or cause communication errors.

The instrument accepts a line feed (LF) as an end of string (EOS) terminator.

4.2 Device State

The device may be in one of the four possible states described below. The transition between states is defined by IEEE 488.1.

4.2.1 Local State (LOCS)

In the LOCS the device may be operated from the front panel only. Its settings may be queried over the GPIB, but not changed. Commands that do not affect the signal being output by the instrument are accepted.

4.2.2 Local With Lockout State (LWLS)

In the LWLS the device may be operated from the front panel only. Its settings may be queried over the GPIB, but not changed. Commands that do not affect the signal being output by the instrument are accepted. The difference between the LOCS and the LWLS is that from the LWLS the device may enter the Remote With Lockout State.

4.2.3 Remote State (REMS)

In the REMS the device may be operated from the GPIB. Actuating any front panel key will cause the device state to revert to the LOCS.

4.2.4 Remote With Lockout State (RWLS)

In the RWLS the device is operable only from the GPIB. Front panel operation may be returned by either sending an appropriate IEEE 488.1 command, or by cycling the device power.

4.3 Interface Function Subsets

The following interface function subsets are implemented in the pulse generator:

SH1, AH1, T6, L4, SR1, RL1, PP0, DC1, DT1, E2, C0

4.4 Device Address

The GPIB address of the device may be set to any value from 0 to 31. The address may be changed from the front panel, using the numeric keypad or the rotary encoder, or via the GPIB itself using the command:

```
:SYSTem:COMMunicate:GPIB:ADDRESS
```

Setting the device to address 31 puts it in the 'off-bus' state. In this state it will not respond to messages on the GPIB. If the device is in the REMS when set to address 31, an internal 'return-to-local' command will be given, setting the device to the LOCS. If the device is in the RWLS, the 'return-to-local' command is ignored, and the device remains in the RWLS. The only way to then re-establish communication with the device over the GPIB is to cycle the power, and to then change the address to that required from the front panel.

4.5 Message Exchange Protocol

The device decodes messages using the Message Exchange Protocol (MEP) defined in IEEE 488.2. The following functions implemented in the MEP must be considered:

4.5.1 The Input Buffer

The device has a 128-byte long cyclic input buffer. Decoding of remote messages begins as soon as the input buffer is not empty, that is, as soon as the controller has sent at least one byte to the device. Should the input buffer be filled up by the controller faster than the device can remove the bytes and decode them, the bus handshake is not completed until room has been made for more bytes in the buffer. This prevents a fast controller from overrunning the device with data.

If the user has sent part of a Program Message, but not the Program Message Terminator, and wishes to abort the message decoding and execution, the Device Clear command may be sent, or front panel operation resumed (in REMS only).

4.5.2 The Output Queue

The device has a 100-byte long output queue in which it stores response messages for the controller to read. If at the time a response message is formatted the queue contains previously formatted response messages, such that there are not enough places in the queue for the new message, the device will put off putting the message in the queue until there is place for it.

The Status Byte MAV bit, when set, indicates that part or all of a response message is ready to be read.

4.5.3 Response Messages

The device sends a Response Message in response to a valid query. All queries return a single Response Message Unit, and all query responses are generated at the time the query is parsed.

4.5.4 Coupled Commands

Coupled Commands are either commands whose execution validity depends on the value of other parameters, or commands whose execution changes the value of another parameter. The execution of commands designated as being coupled is deferred until all other commands in the same Program Message have been executed. The coupled commands are then grouped together according to their functionality, and executed as a group. All parameters of the pulse generator are coupled.

4.6 Instrument Identification

The *IDN? common query is used to read the instrument's identification string. The string returned is something similar to the following:

```
B&K, MODEL 4034,0,V0.40
```

4.7 Instrument Reset

The *RST common command effects an instrument reset to the factory default power up state.

4.8 Self Test

The *TST common query causes the device to perform a self test. This self test consists of checking the functionality of the pulse generator.

4.9 Command Syntax

4.9.1 General Command Structure

The device commands are generally defined by the SCPI standard, with the exception of those instrument functions for which SCPI commands do not as yet exist.

The Common Commands and Queries are defined by IEEE 488.2. The command syntax, i.e. how a command is structured, is defined by IEEE 488.2.

4.9.2 The Program Message

A Program Message is defined as a string containing one or more Program Message Units, each of which is an instrument command or query. Program Message Units are separated from each other by the Program Message Unit Separator. The Program Message is terminated by the Program Message Terminator.

The Program Message Unit Separator consists of a semicolon (;), optionally preceded and/or followed by white-space characters. A white-space character is defined as the ASCII characters in the ranges 00H-09H, and 0BH-20H. This range includes the ASCII control characters and the space, but excludes the Linefeed character.

The Program Message Terminator consists of optional white-space characters, followed by one of three options:

- Linefeed (LF) character (ASCII 0A);
- GPIB EOI bus line being set true on the last byte of the message;
- LF being sent with EOI true.

The Program Message Unit can be divided into three sections as follows.

4.9.2.1 Program Message Header

The Program Header represents the operation to be performed, and consists of ASCII character mnemonics. Two types of Program Headers are used in the pulse generator: Instrument-control headers and Common Command and Query headers. A Program Header may consist of more than one mnemonic, in which case the mnemonics are separated from each other by the colon (:). For instrument control commands, the mnemonics are specified by the SCPI standard, and indicate the tree structure of the command set. The first mnemonic indicates the subsystem being controlled. Common Command and Query Program Headers consist of a single mnemonic prefixed by an asterisk (*).

The mnemonics consist of upper- or lower-case alpha characters. Mnemonics may be written in either the long form, in which the entire mnemonic is written out, or the short form, in which only a specified portion of the mnemonic is written out. Some mnemonics have only one form due to their short length. Where a command is described, the portion appearing in upper case is the short form. Only the short form or the long form may be used.

Example: The command to set the period to 1 microsecond may be written in the following ways:

```
SOURCE:PULSE:PERIOD 1US
SOUR:PULS:PER 1US
SOURCE:PULSE:PERIOD 1US
```

Some mnemonics in a specified Program Header may be optional. This is indicated in the command description by the mnemonic being enclosed in square brackets ([...]).

This means it is not necessary to write the mnemonic into the Program Header: it is a default condition. The 'SOURCE' mnemonic, for example, is optional. Not specifying it will cause the device to search for the mnemonics in the Program Header under the Source Subsystem. For example, the period may be set by the command:

```
:PULS:PER 1US
```

4.9.2.2 Program Message Header Separator

The Program Header Separator is used to separate the program header from the program data. It consists of one or more white-space characters, denoted as <ws>. Typically, it is a space.

4.9.2.3 Program Message Data

The Program Data represent the values of the parameters being set, for example, the '1US' in the above examples. Different forms of program data are accepted, depending on the command. The Program Data types used in the pulse generator are as follows:

1. Character program data – This form of data is comprised of a mnemonic made up of lower - or upper-case alpha characters. As with Program Header mnemonics, some Character Data mnemonics have short and long forms. Only the short or the long form may be used.
2. Boolean data – Boolean data indicate that the parameter can take one of two states, ON or OFF. The parameter may be character type ON or OFF or numeric. A numeric value is rounded to an integer. A non-zero result is interpreted as 1 (ON), and a zero result as 0 (OFF). Queries return the values 0 or 1.
3. NRf – This is a decimal numeric data type, where
NR1 indicates an integer number,
NR2 indicates a fixed-point real number, and
NR3 indicates a floating-point real number.

All parameters that have associated units accept a suffix, which may be specified using upper - or lower-case characters. When the suffix is not specified, the numeric value is accepted in the default units, which are Hertz for frequency, Seconds for time, and Volts for voltage. To set the period to 1 microsecond we can send one of the following commands:

```
:PULS:PER 1E-6 or :PULS:PER 1000NS
```

The special forms of character data accepted as numbers as defined by SCPI are NOT accepted by the pulse generator.

There are two types of Program Message Units: Command Message Units and Query Message Units. A Query differs from a Command in that the Program Header is terminated with a question mark ('?'). For example, the period might be queried with the following query:

```
:PULS:PER?
```

Not all Program Message units have query forms, such as STATUS:PRESET, and some Program Message Units might have only the query form, such as SYSTEM:VERSION?. The pulse generator puts the response to the query into the output queue, from where it may be read by the controller. The Status Byte MAV bit is set to indicate to the controller that a response is ready to be read.

4.9.3 SCPI Command Structure

SCPI commands are based on a hierarchical structure. This allows the same instrument-control

header to be used several times for different purposes, providing that the mnemonic occurs in a unique position in the hierarchy. Each level in the hierarchy is defined as a node. Mnemonics in the different levels are separated from each other by a colon (:). The first Program Message Unit, or command, in a Program Message is always referenced to the root node. Subsequent commands are referenced to the same level as the previous command.

A Program Message Unit having a colon as its first character causes the reference to return to the root. This process is defined by IEEE 488, section A.1.1. Consider the following examples:

1. The following command may be used to set the high and low levels of the pulse. Note that the LOW command is referenced to the command preceding it. The LOW mnemonic resides at the same node as the HIGH command.

```
SOURCE:VOLTAGE:HIGH 5V;LOW 2V
```

-
2. This command sets the frequency and the high level. The FREQUENCY and VOLTAGE mnemonics are at the same level.

SOURCE:FREQUENCY 2KHZ;VOLTAGE:HIGH 4V

3. When Program Message Units describe different subsystems, a colon prefix must be used to reset the command reference to the root. Here the frequency and the output state are set.

SOURCE:FREQUENCY 3KHZ;:OUTPUT:STATE ON

Common Commands may be inserted in the Program Message without affecting the instrument-control command reference. For example,

SOURCE:VOLTAGE:HIGH 4V;*ESE 255;LOW 2V

4.10 Status Reporting

The instrument is capable of reporting status events and errors to the controller, using the IEEE 488.1 Service Request function and the IEEE 488.2 Status Reporting structure.

4.10.1 The Status Byte

Status summary information is communicated from the device to the controller using the Status Byte (STB). The STB is composed of single-bit summary-messages, each summary message summarizing an overlying Status Data Structure. By examining the content of the STB, the controller gains some information concerning the instrument's status. The STB bits are defined as follows:

Bit 0: Unused

Bit 1: Unused

Bit 2: Error/event queue summary message (EVQ). This bit is set if the queue is not empty.

Bit 3: Questionable Status summary message. This bit is not used by the pulse generator.

Bit 4: Message Available (MAV) summary message. This bit is set whenever all or part of a message is available for the controller to read. The controller may be ready to read the response message before it is available, in which case it can either wait until this bit is set, or it can start to read. In the second case, the controller time-out must be set so that the read action will not be aborted before the message has been read.

Bit 5: Event Status Bit (ESB) summary message. This bit is set to indicate that one or more of the enabled standard events have occurred.

Bit 6: Request Service (RQS). This bit is set when the device is actively requesting service.

Bit 7: Operation Status summary message. No Operation Status events are defined in the pulse generator, and so this bit is never set.

The STB is read by the controller during a serial poll. If the RQS bit was set, it is then cleared. The STB may also be read by the *STB? common query.

4.10.2 Service Request Enabling

Service request enabling allows the user to select which Status Byte summary messages may cause the device to actively request service. This is achieved using the Service Request Enable Register, which is an 8-bit register whose bits correspond to those of the STB. The RQS bit in the STB is set when a bit in the STB is set, and its corresponding bit in the service request enable register is set.

The service request enable register is set using the *SRE common command, and read using the *SRE? common query.

4.10.3 Standard Event Status Register

The Standard Event Status Register (SESR) is defined by IEEE 488.2. It is implemented in the pulse generator as a byte, whose bits have the following definitions:

- Bit 0: Operation Complete (OPC). This bit is set in response to the *OPC common command being executed.
- Bit 1: Request Control (RQC). Not implemented in the PG.
- Bit 2: Query Error (QYE). This bit is set when either the controller is attempting to read data from the device when none is available, or when data prepared for the controller to read has been lost.
- Bit 3: Device-Specific Error (DDE). This bit is set to indicate that a device operation did not execute due to some device condition.
- Bit 4: Execution Error (EXE). This bit is set when the device could not execute a command, due to the command being outside of its capabilities. For example, a parameter being out of range.
- Bit 5: Command Error (CME). This bit is set to indicate an error in the command syntax.
- Bit 6: User Request (URQ). This bit is not used by the pulse generator.
- Bit 7: Power On (PON). This bit is set when the device is powered on.

The SESR is queried using the *ESR? common query.

The SESR is paired with an enable register, the Standard Event Status Enable Register (SESER). This register enables one or more events in the SESR to be reflected in the Status Byte ESB summary message bit. The bits of the SESER correspond to those of the SESR. Setting a bit in the SESER enables the corresponding event to set the ESB bit when it occurs. The SESER is set with the *ESE common command and queried with the *ESE? command query.

4.10.4 The Error Queue

The error queue is used to store codes of errors detected in the device. It is implemented as a cyclic buffer of length 10. When the error queue is not empty, bit EVQ in the Status Byte is set. The error queue is read with either one of the following two queries:

```
:SYSTEM:ERROR?  
:STATUS:QUEUE:NEXT?
```

The first error in the queue is returned, and the queue is advanced.

4.10.5 Error Codes

The negative error codes are defined by SCPI. Positive codes are specific to the PG. The error message is returned in the following form:

```
<error number>,"<error description>"
```

A table of error numbers and their descriptions is presented here.

No error reported

0 No error

4.10.5.1 Command Errors

A command error is in the range -199 to -100, and indicates that a syntax error was detected. This includes the case of an unrecognized header. The occurrence of a command error causes the CME bit (bit 5) of the Standard Event Status Register to be set.

Code	Description
-100	Command Error
-101	Invalid character
-102	Syntax error
-103	Invalid separator
-104	Data type error
-105	GET not allowed
-108	Parameter not allowed – More parameters than allowed were received
-109	Missing parameter – Fewer parameters than necessary were received
-110	Command header error
-111	Header separator error
-112	Program mnemonic too long – The mnemonic must contain no less than 12 characters
-113	Undefined header
-114	Header suffix out of range
-120	Numeric data error
-121	Invalid character in number
-123	Exponent too large – IEEE 488.2 specifies maximum of 32000
-124	Too many digits – IEEE 488.2 specifies maximum of 255 digits in mantissa.
-128	Numeric data not allowed – A different data type was expected
-131	Invalid suffix
-134	Suffix too long – A maximum of 12 characters are allowed in a suffix
-138	Suffix not allowed
-140	Character data error
-141	Invalid character data – Incorrect character data were received
-144	Character data too long – Character data may contain no more than 12 characters
-148	Character data not allowed
-158	String data not allowed
-168	Block data not allowed
-178	Expression data not allowed

4.10.5.2 Execution Errors

An execution error indicates that the device could not execute a syntactically correct command, either since the data were out of the instrument's range, or due to a device condition. The EXE bit (bit 4) of the Standard Event Status Register is set on occurrence of an execution error.

Code	Description
-200	Execution error
-201	Invalid while in local – An attempt was made to change an instrument setting while the instrument was in the LOCAL state
-211	Trigger ignored – The GET or *TRG common command was ignored due to the device not being in the correct state to execute the trigger
-221	Settings conflict – The parameter is out of range due to the current instrument state
-222	Data out of range – The parameter exceeds the absolute limits

4.10.5.3 Device-Specific Errors

An error specific to the device occurred. The DDE bit (bit 3) of the Standard Event Status Register is set.

Code	Description
-315	Configuration memory lost – Device memory has been lost. Check the back-up battery
-330	Self-test failed
-350	Queue overflow – Error codes have been lost due to more than 10 errors being reported without being read

4.10.5.4 Query Errors

A query error indicates that the output queue control has detected a problem. This could occur if either an attempt was made to read data from the instrument if none was available, or when data were lost. Data could be lost when a query causes data to be formatted for the controller to be read, and the controller sends more commands without reading the data.

Code	Description
-410	Query INTERRUPTED – Data were sent before the entire response of a previous query was read
-420	Query UNTERMINATED – An attempt was made to read a response before the complete program message meant to generate that response was sent
-430	Query DEADLOCKED – The input buffer and output queue are full, and the controller is attempting to send more data. In this case the output queue and input buffers will be cleared. Parsing will resume after the END message is detected
-440	Query UNTERMINATED after indefinite response – A query was received in the same program message after a query requiring an indefinite response was formatted. Essentially this means that the *IDN? common query and the :ARB:DATA? query should not be followed by more query messages in the same program message

4.10.5.5 System Events

System events have positive valued codes. They are not defined by SCPI, but are specific to the pulse generator.

Code	Description
401	Power on
402	Operation complete – The *OPC command as been executed

Warnings

The execution of some commands might cause an undesirable instrument state. The commands are executed, but a warning is issued. Sending the :STATus:PRESet command disables reporting of warnings. The existence of these conditions causes a bit in the Status Questionable Condition register to be set.

For Model 4033

500 Trigger rate short
510 Output overload

For Model 4034

500 Trigger rate short on channel 1
501 Trigger rate short on channel 2
510 Output overload on channel 1
511 Output overload on channel 2

"Trigger rate short" means that the period of the waveform is larger than the value of the internal trigger rate. Thus not every trigger will generate a cycle (or burst) of the waveform.

4.11 IEEE 488.2 Common Commands and Queries

4.11.1 System Data Commands

The identification query command, *IDN?, enables unique identification of the device over the GPIB. It returns a string with four fields:

Manufacturer name
Model name
Serial number (0 if not relevant)
Version number

4.11.2 Internal Operation Commands

4.11.2.1 *RST - Reset Command

The Reset command resets the device and returns it to the factory default power-up state.

Command Type: Common Command

Syntax: *RST

4.11.2.2 *TST? - Self-Test Query

The self-test query causes an internal self-test to be performed. This test consists of checking the status of the period, pulse and output cards.

Command Type Common Query

Syntax *TST?

Response ASCII 0 if test passes
ASCII 1 if test fails

4.11.3 Synchronization Commands

4.11.3.1 *OPC - Operation Complete Command

The operation complete command causes the device to generate the operation complete message in the Standard Event Status Register, on completion of the selected device operation.

Command Type: Common Command

Syntax: *OPC

Examples: PULS:PER 1US;*OPC

The *OPC command (and the *OPC? query described below) find use mainly when commands having relatively long execution times are executed, although all commands execute without any appreciable delay.

4.11.3.2 *OPC? - Operation Complete Query

The operation complete query places an ASCII character 1 in the output queue on completion of the selected device operation.

Command Type: Common Query
Syntax: *OPC?
Response: ASCII character 1
Example: PULS:PER 1US;*OPC?

4.11.3.3 *WAI - Wait-to-Continue Command

This command is intended for use with overlapped commands. No commands in the pulse generator are overlapped, and so this command has no effect.

Command Type: Common Command
Syntax *WAI

4.11.4 Status and Event Commands

4.11.4.1 *CLS - Clear Status

The clear status command clears the SESR and Error Queue status data structures.

COMMAND TYPE: Common Command
Syntax:: *CLS

4.11.4.2 *ESE - Standard Event Status Enable

This command is used to set the value of the Standard Event Status Enable Register.

COMMAND TYPE: Common Command or Query

COMMON COMMAND

Syntax: *ESE<ws><NRf>
Arguments:
Type: NRf
Range: 0 to 255. Non integer arguments are rounded before execution.
Examples: *ESE 48 (Enables the CME and EXE bits)
*ESE 255 (Enables all standard events)

QUERY

Syntax: *ESE?
Response: <NR1>

4.11.4.3 **ESR? - Standard Event Status Register Query*

This query is used to read the value of the Standard Event Status Register. Reading the register clears it.

COMMAND TYPE: Common Command or Query

Syntax: *ESR?

Response: <NR1>

4.11.4.4 **PSC - Power-On Status Clear Command*

This command is used to control the automatic power-on clearing of certain status functions.

COMMAND TYPE: Common Command or Query

COMMON COMMAND

Syntax : *PSC<ws><Boolean>

Arguments:

Type: Boolean

Examples: *PSC ON or *PSC 1
*PSC OFF or *PSC 0

QUERY

Syntax: *PSC?

Response: ASCII 0 for OFF
ASCII 1 for ON

When set to ON (1), the Service Request Enable Register and the Standard Event Status Enable Register are cleared on power-on.

4.11.4.5 **SRE - Service Request Enable Command*

This command sets the Service Request Enable Register bits.

COMMAND TYPE: Common Command or Query

COMMON COMMAND

Syntax: *SRE<ws><NRf>

Arguments:

Type: NRf

Range: 0 to 255. Non integer arguments are rounded before execution.
The value of bit 6 is ignored, and is set always to zero.

Examples: *SRE 48 (Enables reporting of ESB and MAV events)

QUERY

Syntax: *SRE?

Response: <NR1>

f) STB? - Status byte query

This query is used to read the value of the Status Byte.

COMMAND TYPE: Common Query

Syntax : *STB?

Response: <NR1>

The value of the Status Byte read with the *STB? query may differ from that read with the Serial Poll. Bit 6 of the STB will be set as long as a reason for requesting service exists, while bit 6 of the STB as read by the Serial Poll is cleared by the Serial Poll.

4.11.5 Device Trigger Commands

*TRG - Trigger command

This command is analogous to the IEEE 488.1 Group Execute Trigger interface message, and has the same effect. It is used to trigger the device to output a wave, and is accepted only when the trigger mode is set to Trigger, Gate or Burst, and the trigger source is set to BUS.

Command Type: Common Command

Syntax: *TRG

4.11.6 Stored Settings Commands

4.11.6.1 *RCL - Recall Instrument State

This command is used to restore the state of the device to that stored in the specified memory location.

COMMAND TYPE: Common Command

Syntax: *RCL<ws><NRf>

Arguments:

Type: <NRf>

Range: 0 to 99. Non integer values are rounded before execution

Example: *RCL 0 (Recall default state)
*RCL 99

4.11.6.2 *SAV - Save Instrument State

This command is used to store the current instrument state in the specified memory location.

COMMAND TYPE: Common Command

Syntax: *SAV<ws><NRf>

Arguments:

Type: <NRf>

Range: 1 to 98. Non integer values are rounded before execution

Example: *SAV 25

Stored setting location 0 stores the factory defaults, and is a read-only location. Location 99 stores a copy of the current instrument setting, and it, too, is read-only.

4.12 Instrument Control Commands

Instrument control commands are grouped into logical subsystems according to the SCPI instrument model. The commands are comprised of mnemonics indicating the subsystem to which the command belongs, and the hierarchy within that subsystem. When the command is to be referred to the Root node, it should be prefixed with a colon (:). Mnemonics appearing in square brackets [...] are optional. The '|' character is used to denote a choice of specifications. The '<ws>' is used to denote a white space character.

4.12.1 SOURce Subsystem

The Source Subsystem controls the frequency, voltage and pulse characteristics. The command structure is as follows:

```
:SOURce
  :FREQuency
    [:CW|FIXed] <NRf>
  :VOLTagE
    [:LEVel]
      [:IMMediate]
        HIGH <NRf>
        LOW <NRf>
        PREDeFined TTL|CMOS|ECL|USER
        PHIGH <NRf>
        PLOW <NRf>
      :LIMit
        HIGH <NRf>
        LOW <NRf>
  :PULSe
    :PERiod <NRf>
    :WIDTh <NRf>
    :DELay <NRf>
    :DCYCLE <NRf>
    :HOLD WIDTH|DCYCLE
    :EWIDth <Boolean>
    :DOUBle
      [:STATe] <Boolean>
      :DELay <NRf>
    :TRANsition
      [:LEADing] <NRf>
      :TRAILing <NRf>
      :AUTO <Boolean>|ONCE
    :POLarity NORMAl|COMPLement|INVERTed
  :COUP
```

MODEL 4034 ONLY:

To control channel 2, change the subsystem from :SOUR to :SOUR2. For example, to check pulse period of channel 2, send the command :SOUR2:PULS:PER?

4.12.1.1 Frequency

The frequency command controls the frequency of the pulse in the continuous trigger mode. It is the inverse of the period.

COMMAND TYPE: Setting or Query

SETTING

Syntax: [:SOURce]:FREQuency[:CW|FIXed]<ws><frequency>[units]

Arguments:

Type: NRf
Units: MHz, kHz, Hz (default)

Range: 0.1Hz to 50MHz
Rounding: To the resolution of the range.
Examples: :FREQ 5KHZ
:FREQ 5E3

QUERY

Syntax: [:SOURce]:FREQuency[:CW]:FIXed]?
Examples: :FREQ?
Response: NR3

CONSIDERATIONS: FIXed is an alias for CW.

4.12.1.2 High Voltage Level

This command is used to set the high level of the pulse.

COMMAND TYPE: Setting or Query

SETTING

Syntax: [:SOURce]:VOLTage[:LEVel][:IMMEDIATE]:HIGH<ws><high level>[units]
Arguments:
Type: NRf
Units: MV, V (default)
Range: -9.5V to +10V
Rounding: To 10mV
Examples: VOLT:HIGH 4V

QUERY

Syntax: [:SOURce]:VOLTage[:LEVel][:IMMEDIATE]:HIGH?
Examples: :VOLT:HIGH?
Response: NRf

CONSIDERATIONS:

- 1) The high level must be greater than the low level.
- 2) The difference between the levels must conform to $0.5V \leq \text{difference} \leq 10V$
- 3) The high level may not exceed the high limit.

4.12.1.3 Low Voltage Level

This command is used to set the low level of the pulse.

COMMAND TYPE: Setting or Query

SETTING

Syntax: [:SOURce]:VOLTage[:LEVel][:IMMEDIATE]:LOW<ws><low level>[units]
Arguments:
Type: NRf
Units: MV, V (default)
Range: -10V to +9.5V
Rounding: To 10mV
Examples: :VOLT:LOW 4V

QUERY

Syntax: [:SOURce]:VOLTage[:LEVel][:IMMEDIATE]:LOW?

Examples: :VOLT:LOW?

Response: NRf

CONSIDERATIONS:

- 1) The high level must be greater than the low level.
- 2) The difference between the levels must conform to $0.5V \leq \text{difference} \leq 10V$
- 3) The low level may not be less than the low limit.

4.12.1.4 Predefined High Voltage Level

This command is used to set the predefined high level of the pulse. The pulse will be set when the predefined USER levels are invoked to this high level.

COMMAND TYPE: Setting or Query

SETTING

Syntax: [:SOURce]:VOLTage[:LEVel][:IMMediate]:PHIGH<ws>
<predef high level>[units]

Arguments:

Type: NRf
Units: MV, V (default)
Range: -9.5V to +10V
Rounding: To 10mV
Example: :VOLT:PHIGH 4V

QUERY

Syntax: [:SOURce]:VOLTage[:LEVel][:IMMediate]:PHIGH?

Example: :VOLT:PHIGH?

Response: NRf

4.12.1.5 Predefined Low Voltage Level

This command is used to set the predefined low level of the pulse. The pulse will be set when the predefined USER levels are invoked to this low level.

COMMAND TYPE: Setting or Query

SETTING

Syntax: [:SOURce]:VOLTage[:LEVel][:IMMediate]:PLOW<ws>
<predef low level>[units]

Arguments:

Type: NRf
Units: MV, V (default)
Range: -10V to +9.5V
Rounding: To 10mV
Examples: :VOLT:PLOW 4V

QUERY

Syntax: [:SOURce]:VOLTage[:LEVel][:IMMediate]:PLOW?

Examples: :VOLT:PLOW?

Response: NRf

4.12.1.6 *Predefined Voltage Levels*

This command is used to set the pulse voltage levels to predefined values. Four predefined values are available as follows:

CMOS: High level 5V; Low level 0V
TTL: High level 2.4V; Low level 0.4V
ECL: High level -0.8V; Low level -1.8V
USER: User-defined levels, as set using the PHIGH and PLOW commands

COMMAND TYPE: Setting only

SETTING

Syntax: [:SOURce]:VOLTage[:LEVel][:IMMediate]:PREDeFined<ws><option>

Arguments:

Type: Character

Options: CMOS, TTL, ECL, USER

Examples: :VOLT:PREDECL

4.12.1.7 *High Voltage Limit*

This command is used to set the high limit of the pulse.

COMMAND TYPE: Setting or Query

SETTING

Syntax: [:SOURce]:VOLTage:LIMit:HIGH<ws><high limit>[units]

Arguments:

Type: NRf

Units: MV, V (default)

Range: -9.5V to +10V

Rounding: To 10mV

Examples: :VOLT:LIM:HIGH 4V

QUERY

Syntax: [:SOURce]:VOLTage:LIMit:HIGH?

Examples: :VOLT:LIM:HIGH?

Response: NRf

CONSIDERATIONS:

The high limit cannot be set to less than the high level.

4.12.1.8 *Low Voltage Limit*

This command is used to set the low limit of the pulse.

COMMAND TYPE: Setting or Query

SETTING

Syntax: [:SOURce]:VOLTage:LIMit:LOW<ws><low limit>[units]

Arguments:

Type: NRf

Units: MV, V (default)

Range: -10V to +9.5V

Rounding: To 10mV

Examples: VOLT:LIM:LOW 4V

QUERY

Syntax: [:SOURce]:VOLTage:LIMit:LOW?
Examples: :VOLT:LIM:LOW?
Response: NRf

CONSIDERATIONS:

The low limit cannot be set greater than the low level.

4.12.1.9 Pulse Period

This command is used to set or query the period of the pulse.

COMMAND TYPE: Setting or Query

SETTING

Syntax: [:SOURce]:PULSe:PERiod<ws><period>[units]
Arguments:
Type: NRf
Units: S (seconds), MS (milliseconds), US (microseconds), NS nanoseconds
Range: 20NS to 10S
Rounding: To current resolution
Examples: :PULS:PER 1US
:PULS:PER 400E-6

QUERY

Syntax: [:SOURce]:PULSe:PERiod?
Examples: :PULS:PER?
Response: NRf

CONSIDERATIONS:

The allowed range of the period will be determined by the values of the width, delay, and transition times.

4.12.1.10 Pulse Width

This command is used to set or query the value of the pulse width. If the duty cycle is ON when the width command is sent, it is then set to OFF, and changes in the period will no longer affect the width.

COMMAND TYPE: Setting or Query

SETTING

Syntax: [:SOURce]:PULSe:WIDTh<ws><width>[units]
Arguments:
Type: NRf
Units: S (seconds), MS (milliseconds), US (microseconds), NS nanoseconds
Range: 10NS to 9.89999S
Rounding: To current resolution
Examples: :PULS:WIDT 25NS
:PULS:WIDT 200E-9

QUERY

Syntax: [:SOURce]:PULSe:WIDTh?

Examples: :PULS:WIDT?

Response: NRf

CONSIDERATIONS:

The allowed range of the width will be determined by the values of the period, delay, and transition times.

4.12.1.11 *Pulse Delay*

This command is used to set the delay from the trigger signal to the start of the pulse in single pulse mode. Although there exists a separate command for the double pulse delay, both commands affect the same delay, and so this command will also determine the time between the two pulses in the double pulse mode.

COMMAND TYPE: Setting or Query

SETTING

Syntax: [:SOURce]:PULSe:DELay<ws><delay>[units]

Arguments:

Type: NRf

Units: S (seconds), MS (milliseconds), US (microseconds), NS nanoseconds

Range: 0NS to 9.80000S

Rounding: To current resolution

Examples: :PULS:DELay 25NS

 :PULS:DEL 200E-9

QUERY

Syntax: [:SOURce]:PULSe:DELay?

Examples: :PULS:DEL?

Response: NRf

CONSIDERATIONS:

The allowed range of the delay will be determined by the values of the period, width, and transition times.

4.12.1.12 *Pulse Duty Cycle*

This command is used to set the duty cycle of the pulse. Once the duty cycle has been set it is considered to be ON, and then changes in the period will automatically cause changes in the width, such that the duty cycle is kept constant. The duty cycle is set OFF by either setting the pulse width, or by the PULSE:HOLD WIDTH command. Querying the duty cycle when it is off will return the value zero (0).

COMMAND TYPE: Setting or Query

SETTING

Syntax: [:SOURce]:PULSe:DCYCLe<ws><duty>[units]

Arguments:

Type: NRf

Units: None

Range: 1% to 99%

Rounding: To 0.1%

Examples: :PULS:DCYC 25

QUERY

Syntax: [:SOURce]:PULSe:DCYClE?
Examples: :PULS:DCYC?

4.12.1.13 *Pulse Hold*

This command is used to determine whether the width or the duty cycle are to be held constant when the period is changed. The duty cycle is termed to be ON when changes in the period cause changes in the width, such that the duty cycle remains constant. This state is achieved by specifying the DCYClE parameter in the HOLD command. The duty cycle is set OFF by specifying the WIDTH parameter, and then changes in the period will not affect the width. When setting the duty cycle OFF, the last value is remembered, which is the value the duty cycle takes when it is next set ON.

COMMAND TYPE: Setting or Query

SETTING

Syntax: [:SOURce]:PULSe:HOLD<ws><option>
Arguments:
 Type: Character
 Options: WIDTHh, DCYClE
 Examples: :PULS:HOLD WIDTHh
 :PULS:HOLD DCYC

QUERY

Syntax: [:SOURce]:PULSe:HOLD?
Examples: :PULS:HOLD?
Response: WIDT | DCYC

4.12.1.14 *External Width*

This command is used to enable or disable the external width function. When enabled (ON), this function causes an externally applied pulse to be generated with the same width, but with transition times and output levels as specified by the instrument. When the external width is enabled, the pulse parameter period, width, delay and duty cycle may not be specified. Doing so will cause error 221 to be returned. Also, the double pulse mode may not be enabled while the external width is enabled.

COMMAND TYPE: Setting or Query

SETTING

Syntax: [:SOURce]:PULSe:EWIDth<ws><Boolean>
Arguments:
 Type: Boolean
 Examples: :PULS:EWID ON
 :PULS:EWID OFF

QUERY

Syntax: [:SOURce]:PULSe:EWIDth?
Examples: :PULS:EWID?
Response: 0 | 1

4.12.1.15 *Double Pulse State*

This command is used to enable or disable the double pulse mode. In this mode, two pulses are generated per period. The first pulse is generated at the time of the signal trigger, and the second pulse

is generated after a programmable delay. This delay is set by either the :PULSE:DELAY or the :PULSE:DOUBLE:DELAY command.

COMMAND TYPE: Setting or Query

SETTING

Syntax: [:SOURce]:PULSe:DOUBle[:STATe]<ws><Boolean>

Arguments:

Type: Boolean

Examples: :PULS:DOUB ON
:PULS:DOUB:STAT OFF

QUERY

Syntax: [:SOURce]:PULSe:DOUBle[STATe]?

Examples: :PULS:DOUB?

Response: 0 | 1

4.12.1.16 Double Pulse Delay

This command is used to set the delay of the second pulse, from the time of the trigger, in the double pulse mode. It has exactly the same effect as the :PULSE:DELAY command, and is included in the command set for compatibility purposes.

COMMAND TYPE: Setting or Query

SETTING

Syntax: [:SOURce]:PULSe:DOUBle:DELay<ws><delay>[units]

Arguments:

Type: NRf

Units: S (seconds), MS (milliseconds), US (microseconds), NS nanoseconds

Range: 0NS to 9.80000S

Rounding: To current resolution

Examples: :PULS:DOUB:DELay 150NS

QUERY

Syntax: [:SOURce]:PULSe:DOUBle:DELay?

Examples: :PULS:DOUB:DEL?

Response: NRf

CONSIDERATIONS:

The allowed range of the delay will be determined by the values of the period, width, and transition times.

4.12.1.17 Leading Edge Time

This command is used to set the value of the leading edge time. If the edge-tracking feature is ON, changing the leading edge will cause the same change in the trailing edge.

COMMAND TYPE: Setting or Query

SETTING

Syntax: [:SOURce]:PULSe:TRANSition[:LEADing]<ws><lead time>[units]

Arguments:

Type: NRf
Units: S (seconds), MS (milliseconds), US (microseconds), NS nanoseconds
Range: 5NS to 10MS
Rounding: To current resolution
Examples: :PULS:TRAN:LEAD 50NS
:PULS:TRAN 85NS

QUERY

Syntax: [[:SOURce]:PULSe:TRANsition[:LEADing]?)
Examples: :PULS:TRAN:LEAD?
Response: NRf

CONSIDERATIONS:

The allowed value of the leading edge time is limited by the values of the period, width and delay. In addition, the ratio between the transition times is limited to a maximum of 20:1, and both transition times must be in one of the following ranges:

5ns to 100ns
50ns to 1 us
500ns to 10us
5us to 100us
50us to 1ms
500us to 10ms

4.12.1.18 Trailing Edge Time

This command is used to set the value of the trailing edge time. If the edge-tracking feature is ON, changing the trailing edge will cause the same change in the leading edge.

COMMAND TYPE: Setting or Query

SETTING

Syntax: [[:SOURce]:PULSe:TRANsition[:TRAIling]<ws><trail time>[units]]
Arguments:
Type: NRf
Units: S (seconds), MS (milliseconds), US (microseconds), NS nanoseconds
Range: 5NS to 10MS
Rounding: To current resolution
Examples: :PULS:TRAN:TRA 50NS
:PULS:TRAN:TRAIling 85NS

QUERY

Syntax: [[:SOURce]:PULSe:TRANsition[:TRAIling]?)
Examples: :PULS:TRAN:TRA?
Response: NRf

CONSIDERATIONS:

The allowed value of the trailing edge time is limited by the values of the period, width and delay. In addition, the ratio between the transition times is limited to a maximum of 20:1, and both transition times must be in one of the following ranges:

5ns to 100ns
50ns to 1 us

500ns to 10us
5us to 100us
50us to 1ms
500us to 10ms

4.12.1.19 *Pulse Polarity*

This command is used to control the polarity of the pulse, which may be normal or complemented. The COMPement and INVerted parameters are aliases: either may be used.

COMMAND TYPE: Setting or Query

SETTING

Syntax: [:SOURce]:PULSe:POLarity<ws><Option>

Arguments:

Type: Character

Options: NORMal – Normal polarity
COMPliment – complemented

INVerted – complemented

Examples: :PULS:POL NORM
:PULS:POL INVerted

QUERY

Syntax: [:SOURce]:PULSe:POLarity?

Examples: :PULS:POL?

Response: NORM | COMP

4.12.1.20 *Channel Dependency*

This command is used to control the dependency of channel 2. It can select either for channel 2 to be an independent channel, or set it to be dependent on channel 1. This means that channel 2 will have the same clock and trigger, as well as same frequency and period as channel 1.

COMMAND TYPE: Setting or Query

SETTING

Syntax: :SOURce:COUP <Option>

Arguments:

Type: Character

Options: ON or 1 – Dependent on channel 1

OFF or 0 – Independent

Examples: :SOUR:COUP 1
:SOUR:COUP OFF

QUERY

Syntax: :SOURce: COUP?

Examples: :SOUR:COUP?

Response: 1 | 0

4.12.2 OUTPut Subsystem

The Output Subsystem controls characteristics of the source's output. The OUTPut command controls whether the output is ON or OFF.

COMMAND TYPE: Setting or Query

SETTING

Syntax: [:OUTPut]:STATe<ws><Boolean>

Arguments:

Type: Boolean

Examples: :OUTP:STAT ON
:OUTP OFF

QUERY

Syntax: :OUTPut[:STATe]?

Response: 0 | 1

MODEL 4034 ONLY:

To control output of channel 2, change the subsystem from :OUTP to :OUTP2. For example, to turn on output of channel, send command :OUTP2:STAT ON.

4.12.3 Trigger Subsystem

The Trigger Subsystem is used to control the waveform triggering. It is not all SCPI compatible. The command structure is as follows:

:TRIGger

:MODE CONTInuous | TRIGger | GATE | BURSt

:BURSt <NRf>

:SOURce <MANual> | INTernal | EXTernal | BUS

:TIMer <NRf>

:LEVel <NRf>

:DELay <NRf>

:SLOPe POSitive | NEGative

MODEL 4034 ONLY:

To control the trigger mode of channel 2, change the subsystem from :TRIG to :TRIG2. For example, to check trigger mode of channel 2, send the command :TRIG2:MODE?

4.12.3.1 Trigger Mode

This command is used to set the trigger mode. It is not a standard SCPI command.

COMMAND TYPE: Setting or Query

SETTING

Syntax: :TRIGger:MODE<ws><option>

Arguments:

Type: Character

Options: CONTInuous
TRIGger
GATE

Examples: BURSt
:TRIG:MODE CONT
:TRIG:MODE BURS

QUERY

Syntax: :TRIGger:MODE?
Response: CONT | TRIG | GATE | BURS

4.12.3.2 *Trigger Source*

This command is used to select the trigger source, for use in the Trigger, Gate and Burst trigger modes.

COMMAND TYPE: Setting or Query

SETTING

Syntax: :TRIGger:SOURce<ws><option>
Arguments:
Type: Character
Options: MANual – Front panel MAN key
BUS – GPIB trigger (GET or *TRG)
INTernal – Internal trigger
EXTernal – External trigger
Examples: :TRIG:SOUR BUS
:TRIG:SOUR INT

QUERY

Syntax: :TRIGger:SOURce?
Response: MAN | BUS | INT | EXT

4.12.3.3 *Burst Count*

Used to set the number of cycles to be output in the BURST mode. It is not a standard SCPI command.

COMMAND TYPE: Setting or Query

SETTING

Syntax: :TRIGger:BURSt<ws><value>
Arguments:
Type: NRf
Range: 2 to 999999
Rounding: To integer value
Examples: :TRIG:BURS 100

QUERY

Syntax: :TRIGger:BURSt?
Response: NRf
Examples: :TRIG:BURSt?

4.12.3.4 *Internal Trigger Rate*

Sets the rate of the internal trigger.

COMMAND TYPE: Setting or Query

SETTING

Syntax: :TRIGger:TIMer<ws><value>[units]

Arguments:

Type: NRf
Units: S (seconds), MS (milliseconds), US (microseconds), NS nanoseconds
Range: 100NS to 99.99S
Rounding: To current resolution
Examples: :TRIG:TIM 10E-6
:TRIG:TIM 500US

QUERY

Syntax: :TRIGger:TIMer?
Examples: :TRIG:TIM?
Response: NR3

4.12.3.5 External Trigger Level

Used to control the trigger level of the external trigger.

COMMAND TYPE: Setting or Query

SETTING

Syntax: :TRIGger:LEVel<ws><trigger level>[units]

Arguments:

Type: NRf
Units: V, mV
Range: -10V to +10V with 10mV resolution; 0V allowed
Rounding: 10mV
Examples: :TRIG:LEV 5.56

QUERY

Syntax: :TRIGger:LEVel?
Examples: :TRIG:LEV?
Response: NR3

4.12.3.6 Trigger Slope

This command is used to set the external trigger slope on which to trigger.

COMMAND TYPE: Setting or Query

SETTING

Syntax: :TRIGger:SLOPe<ws><Options>

Arguments:

Type: Character
Options: POSitive
NEGative
Examples: :TRIG:SLOP POS
:TRIG:SLOP NEG

QUERY

Syntax: :TRIGger:SLOPe?
Examples: :TRIG:SLOP?
Response: POS | NEG

4.12.4 Status Subsystem

This subsystem controls the SCPI-defined status reporting structures, which are the QUESTIONable and OPERATION status registers, and the error/event queue. The QUESTIONable and OPERATION status registers are mandated by SCPI, and so are implemented, but are not used by the hardware. No status is ever reported through them, and they are not detailed in this manual. The following shows the STATus structure used:

```
:STATus
  :PRESet
  :QUEue
  [:NEXT]?
```

4.12.4.1 Status Preset

This command is used to set certain status values to defined values.

- The OPERATION and QUESTIONable enable registers are cleared.
- The Positive transition filters are set to 32767.
- The Negative transition filters are set to 0.

Since the Questionable and Operation status registers are not used in the model 4033 and 4034, the PRESet command has no real effect.

COMMAND TYPE: Setting only

SETTING

Syntax: :STATus:PRESet

4.12.4.2 Error Queue Read

This query returns the first entry in the error queue and removes that entry from the queue. Its function is identical to that of the :SYSTem:ERRor? query.

COMMAND TYPE: Query only

QUERY

Syntax: :STATus:QUEue[:NEXT]?

Response: <error number>,
“<error description>”

4.12.5 System Subsystem

The SYSTem subsystem collects the functions that are not related to instrument performance. The functions implemented in the pulse generator are security, GPIB address changing, error queue reading, SCPI version reading, and power-on buffer setting (not SCPI-defined). The command structure is as follows:

```
:SYSTem
  :COMMunicate
  :GPIB
  :ADDRess <numeric value>
  :ERRor?
  :VERSion?
  :SECurity
  [STATe] <Boolean>
  :POBuffer <numeric value>
```

4.12.5.1 GPIB Address Change

This command is used to set the GPIB address. Setting the address to 31 puts the instrument in an 'off-bus' state, in which it does not take part in communication over the GPIB. Communication with the instrument can be resumed only by setting the address to a suitable value from the front panel.

COMMAND TYPE: Setting or Query

SETTING

Syntax: :SYSTem:COMMunicate:GPIB:ADDRess<ws><address>

Arguments:

Type: NRf

Range: 0 to 31

Rounding: To integer value

Examples: :SYST:COMM:GPIB:ADDR 20

QUERY

Syntax: :SYSTem:COMMunicate:GPIB:ADDRess?

Response: <address> in NR1 format

4.12.5.2 Error Queue Reading

This query returns the first entry in the error queue, and removes that entry from the queue. Its function is identical to that of the :STATus:QUEue:NEXT? query.

COMMAND TYPE: Query only

QUERY

Syntax: :SYSTem:ERRor?

Response: <error number>,
“<error description>”

4.12.5.3 SCPI Version

This query is used to read the SCPI version to which the instrument complies.

COMMAND TYPE: Query only

QUERY

Syntax: :SYSTem:VERSion?

Response: 1992.0 (NR2 format)

4.12.5.4 Security

This command enables the instrument memory to be cleared. The stored settings are cleared when the Security state is changed from ON to OFF, and the instrument state is returned to the factory power-on default.

COMMAND TYPE: Setting or Query

SETTING

Syntax: :SYSTem:SECurity[:STATe]<ws><boolean>

Arguments:

Type: Boolean
Examples: :SYST:SEC ON
 :SYST:SEC OFF

QUERY

Syntax: :SYSTem:SECurity[:STATe]?
Response: 0 | 1

4.12.5.5 Power-on Buffer

This command is used to set the Power On Buffer setting. The instrument will power-on with the setting stored in that buffer. Setting the value to 99 will result in the instrument powering up in the state it was in before it was powered down.

COMMAND TYPE: Setting or Query

SETTING

Syntax: :SYSTem:POBuffer<ws><buffer>

Arguments:

Type: Numeric
Range: 0 to 99
Rounding: To integer value
Examples: :SYST:POB 99

QUERY

Syntax: :SYSTem:POBuffer? [<ws>MINimum | MAXimum]
Response: Power-on buffer in NR1 format.

4.13 IEEE 488.1 Interface Messages

4.13.1 GET - Group Execute Trigger

The GET is used by the pulse generator as a trigger when it is in either the TRIGGER, GATE or BURST modes, with the trigger source set to BUS. It has the same effect as the *TRG common command.

4.13.2 DCL - Device Clear

In response to the DCL, the PG does the following:

- a) Clears the input buffer and the output queue.
- b) Resets the Message Processing Functions.

4.13.3 SDC - Selected Device Clear

The response is as for the DCL message, when device is addressed to listen.

4.13.4 LLO - Local Lockout

Sending LLO when device is addressed to listen and controller is asserting the REN line will put the device into "Remote with Lock out" state, locking out the front panel.

4.14 SCPI Command Tree

4.14.1 Root Node

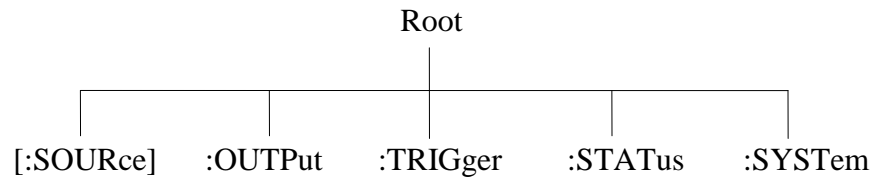

4.14.2 SOURce Subsystem

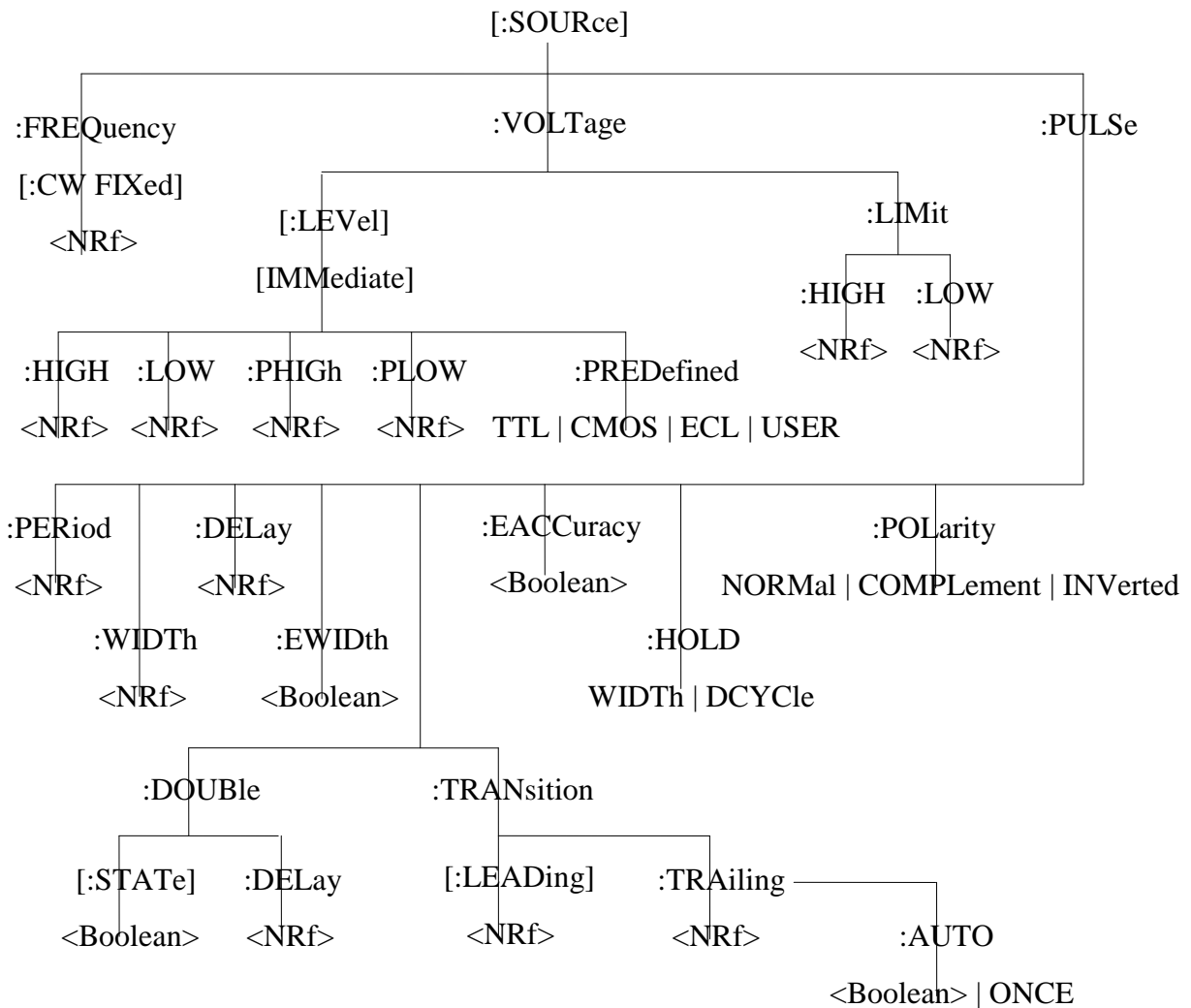

4.14.3 OUTPut Subsystem

```

:OUTPut
 |
[:STATe]
 |
ON | OFF
  
```

4.14.4 TRIGger Subsystem

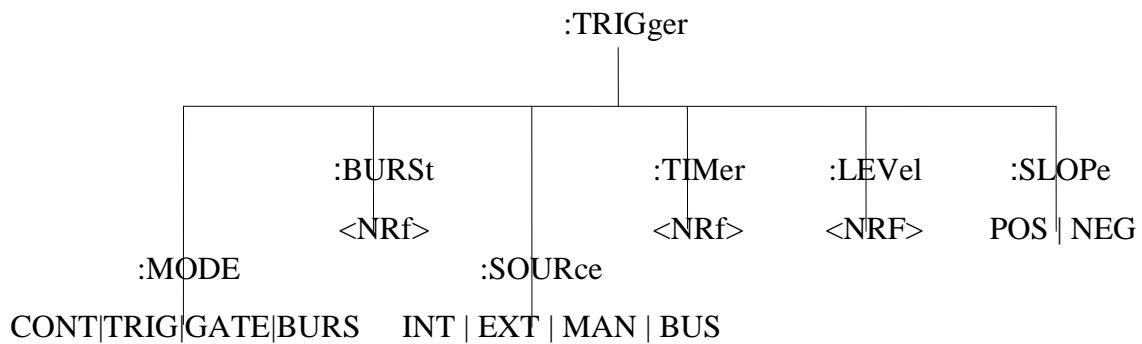

4.14.5 STATus Subsystem

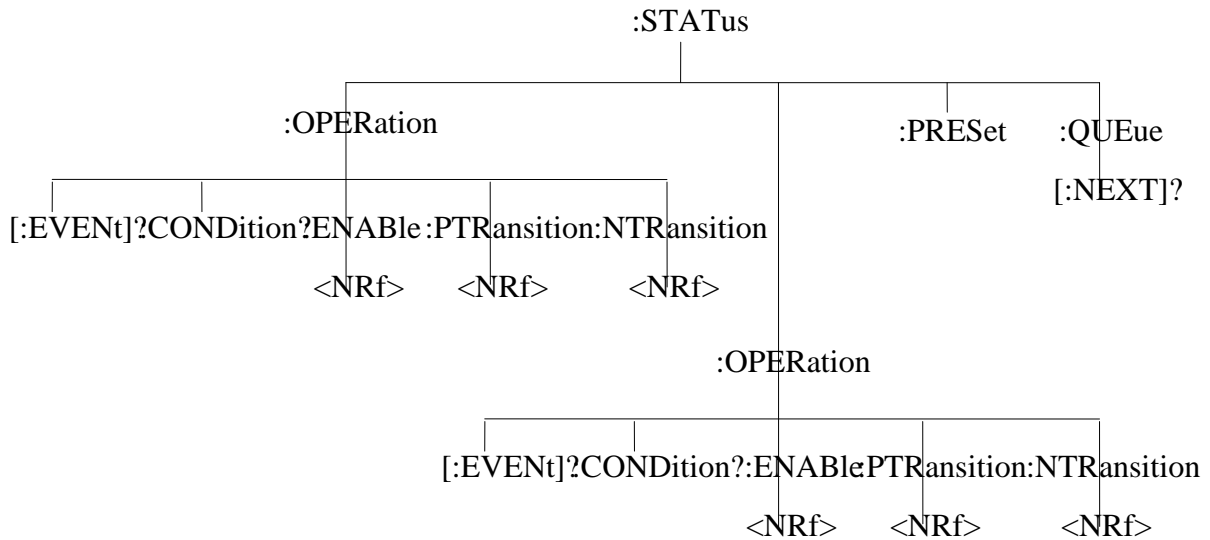

4.14.6 SYSTEM Subsystem

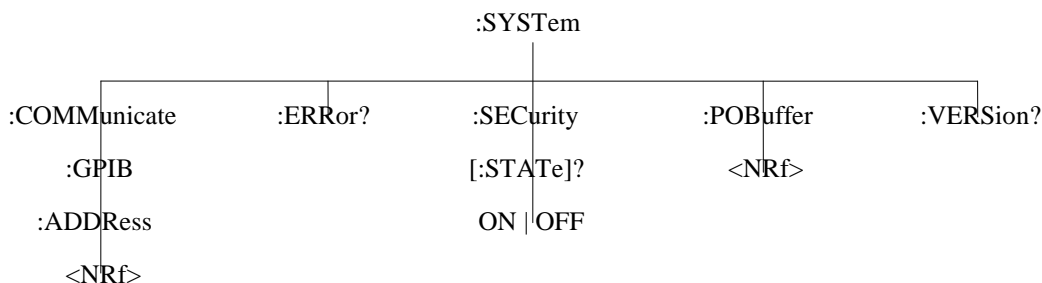

4.15 ASCII and GPIB Code Chart

Hex	Oct	Dec	ASCII	Msg	Hex	Oct	Dec	ASCII	Msg
00	000	0	NUL		20	040	32	SP	MLA0
01	001	1	SOH	GTL	21	041	33	!	MLA1
02	002	2	STX		22	042	34	"	MLA2
03	003	3	ETX		23	043	35	#	MLA3
04	004	4	EOT	SDC	24	044	36	\$	MLA4
05	005	5	ENQ	PPC	25	045	37	%	MLA5
06	006	6	ACK		26	046	38	&	MLA6
07	007	7	BEL		27	047	39	'	MLA7
08	010	8	BS	GET	28	050	40	(MLA8
09	011	9	HT	TCT	29	051	41)	MLA9
0A	012	10	LF		2A	052	42	*	MLA10
0B	013	11	VT		2B	053	43	+	MLA11
0C	014	12	FF		2C	054	44	,	MLA12
0D	015	13	CR		2D	055	45	-	MLA13
0E	016	14	SO		2E	056	46	.	MLA14
0F	017	15	SI		2F	057	47	/	MLA15
10	020	16	DLE		30	060	48	0	MLA16
11	021	17	DC1	LLO	31	061	49	1	MLA17
12	022	18	DC2		32	062	50	2	MLA18
13	023	19	DC3		33	063	51	3	MLA19
14	024	20	DC4	DCL	34	064	52	4	MLA20
15	025	21	NAK	PPU	35	065	53	5	MLA21
16	026	22	SYN		36	066	54	6	MLA22
17	027	23	ETB		37	067	55	7	MLA23
18	030	24	CAN	SPE	38	070	56	8	MLA24
19	031	25	EM	SPD	39	071	57	9	MLA25
1A	032	26	SUB		3A	072	58	:	MLA26
1B	033	27	ESC		3B	073	59	;	MLA27
1C	034	28	FS		3C	074	60	<	MLA28

1D	035	29	GS	3D	075	61	=	MLA29
1E	036	30	RS	3E	076	62	>	MLA30
1F	037	31	US	3F	077	63	?	UNL

Message Definitions

DCL	Device Clear	MSA	My Secondary Address
GET	Group Execute Trigger	MTA	My Talk Address
GTL	Go To Local	PPC	Parallel Poll Configure
LLO	Local Lockout	PPD	Parallel Poll Disable
MLA	My Listen Address		

Hex	Oct	Dec	ASCII	Msg	Hex	Oct	Dec	ASCII	Msg
40	100	64	@	MTA0	60	140	96	`	MSA0,PPE
41	101	65	A	MTA1	61	141	97	a	MSA1,PPE
42	102	66	B	MTA2	62	142	98	b	MSA2,PPE
43	103	67	C	MTA3	63	143	99	c	MSA3,PPE
44	104	68	D	MTA4	64	144	100	d	MSA4,PPE
45	105	69	E	MTA5	65	145	101	e	MSA5,PPE
46	106	70	F	MTA6	66	146	102	f	MSA6,PPE
47	107	71	G	MTA7	67	147	103	g	MSA7,PPE
48	110	72	H	MTA8	68	150	104	h	MSA8,PPE
49	111	73	I	MTA9	69	151	105	i	MSA9,PPE
4A	112	74	J	MTA10	6A	152	106	j	MSA10,PPE
4B	113	75	K	MTA11	6B	153	107	k	MSA11,PPE
4C	114	76	L	MTA12	6C	154	108	l	MSA12,PPE
4D	115	77	M	MTA13	6D	155	109	m	MSA13,PPE
4E	116	78	N	MTA14	6E	156	110	n	MSA14,PPE
4F	117	79	O	MTA15	6F	157	111	o	MSA15,PPE
50	120	80	P	MTA16	70	160	112	p	MSA16,PPD
51	121	81	Q	MTA17	71	161	113	q	MSA17,PPD
52	122	82	R	MTA18	72	162	114	r	MSA18,PPD
53	123	83	S	MTA19	73	163	115	s	MSA19,PPD
54	124	84	T	MTA20	74	164	116	t	MSA20,PPD
55	125	85	U	MTA21	75	165	117	u	MSA21,PPD
56	126	86	V	MTA22	76	166	118	v	MSA22,PPD
57	127	87	W	MTA23	77	167	119	w	MSA23,PPD
58	130	88	X	MTA24	78	170	120	x	MSA24,PPD
59	131	89	Y	MTA25	79	171	121	y	MSA25,PPD
5A	132	90	Z	MTA26	7A	172	122	z	MSA26,PPD
5B	133	91		MTA27	7B	173	123	{	MSA27,PPD
5C	134	92	\	MTA28	7C	174	124		MSA28,PPD

5D	135	93		MTA29	7D	175	125	}	MSA29,PPD
5E	136	94	^	MTA30	7E	176	126	~	MSA30,PPD
5F	137	95	_	UNT	7F	177	127	DEL	

Message Definitions

PPE	Parallel Poll Enable	SPE	Serial Poll Enable
PPU	Parallel Poll Unconfigure	TCT	Take Control
SDC	Selected Device Clear	UNL	Unlisten
SPD	Serial Poll Disable	UNT	Untalk

4.16 RS-232 Programming

4.16.1 General

The INSTALLATION section of this manual describes the RS-232-C connection for the instrument. Be sure that you have the Remote Mode set to RS-232 and correctly set the baud rate.

EIA standard RS-232-C specifies the electrical characteristics and pin out of a serial communication standard for connecting "data terminal equipment" (DTE) to "data communication equipment" (DCE). Data terminal equipment is usually devices such as terminals, computers, or printers that are the final destination for data. Data communication equipment, on the other hand, is usually a modem or other device that converts the data to another form and passes it through. The instrument can be configured only as a DCE, so in most cases it can be connected with a straight-through cable to a computer, but would require special cabling to connect to another DCE device.

The baud rate is the bit rate during the transmission of a word in bits per second. Different devices use many baud rates, but the baud rates of the two devices that are connected must be the same. The instrument can be set to different baud rates ranging from 1200 to 115,000 as described in Section 3, Operating Instructions.

Data signals over the RS-232-C use a voltage of +3V to +25V to represent a zero (called a space) and a voltage of -3V to -25V to represent a one (called a mark). Handshake and control lines use +3V to +25V to indicate a true condition and -3V to -25V to indicate a false condition.

When no data is being transmitted, the idle state of the data lines will be the mark state. To transmit a byte, the transmitting device first sends a start bit to synchronize the receiver.

4.16.2 RS-232-C Operation

The RS-232-C standard is not very specific about many of the handshaking signals and it is therefore usually necessary to refer to the manuals for both of the devices being connected to determine the exact pin out, signal definition, and signal direction for the devices.

The serial interface implements the same SCPI command set as the GPIB interface. The instrument is programmed by sending ASCII coded characters to the instrument.

When the instrument is in the remote mode remote command input has priority over any front panel control. Therefore, as long as the serial interface is continuously supplied with data, the keyboard will appear to be inoperative to the user.

SERVICE INFORMATION

Warranty Service: Please go the support and service section on our website www.bkprecision.com to obtain a RMA #. Return the product in the original packaging with proof of purchase to the address below. Clearly state on the RMA the performance problem and return any leads, probes, connectors and accessories that you are using with the device.

Non-Warranty Service: Please go the support and service section on our website www.bkprecision.com to obtain a RMA #. Return the product in the original packaging to the address below. Clearly state on the RMA the performance problem and return any leads, probes, connectors and accessories that you are using with the device. Customers not on an open account must include payment in the form of a money order or credit card. For the most current repair charges please refer to the service and support section on our website.

Return all merchandise to B&K Precision Corp. with pre-paid shipping. The flat-rate repair charge for Non-Warranty Service does not include return shipping. Return shipping to locations in North America is included for Warranty Service. For overnight shipments and non-North American shipping fees please contact B&K Precision Corp.

B&K Precision Corp.
22820 Savi Ranch Parkway
Yorba Linda, CA 92887
www.bkprecision.com
714-921-9095

Include with the returned instrument your complete return shipping address, contact name, phone number and description of problem.

LIMITED THREE-YEAR WARRANTY

B&K Precision Corp. warrants to the original purchaser that its products and the component parts thereof, will be free from defects in workmanship and materials for a period of three years from date of purchase.

B&K Precision Corp. will, without charge, repair or replace, at its option, defective product or component parts. Returned product must be accompanied by proof of the purchase date in the form of a sales receipt.

To obtain warranty coverage in the U.S.A., this product must be registered by completing a warranty registration form on our website www.bkprecision.com within fifteen (15) days of purchase.

Exclusions: This warranty does not apply in the event of misuse or abuse of the product or as a result of unauthorized alterations or repairs. The warranty is void if the serial number is altered, defaced or removed.

B&K Precision Corp. shall not be liable for any consequential damages, including without limitation damages resulting from loss of use. Some states do not allow limitations of incidental or consequential damages. So the above limitation or exclusion may not apply to you.

This warranty gives you specific rights and you may have other rights, which vary from state-to-state.

B&K Precision Corp.
22820 Savi Ranch Parkway
Yorba Linda, CA 92887
www.bkprecision.com
714-921-9095



BK PRECISION[®]

22820 Savi Ranch Parkway
Yorba Linda, CA 92887
www.bkprecision.com

© 2010 B&K Precision Corp.