



WT-20

Conductivity TDS Meter

Users Manual

- Mode d'emploi
- Bedienungshandbuch
- Manual d'Uso
- Manual de uso



WT-20

Conductivity TDS Meter

Users Manual

English

July 2009, Rev.1
©2009 Amprobe Test Tools.
All rights reserved. Printed in China

Limited Warranty and Limitation of Liability

Your Amprobe product will be free from defects in material and workmanship for 1 year from the date of purchase. This warranty does not cover fuses, disposable batteries or damage from accident, neglect, misuse, alteration, contamination, or abnormal conditions of operation or handling. Resellers are not authorized to extend any other warranty on Amprobe's behalf. To obtain service during the warranty period, return the product with proof of purchase to an authorized Amprobe Test Tools Service Center or to an Amprobe dealer or distributor. See Repair Section for details. THIS WARRANTY IS YOUR ONLY REMEDY. ALL OTHER WARRANTIES - WHETHER EXPRESS, IMPLIED OR STATUTORY - INCLUDING IMPLIED WARRANTIES OF FITNESS FOR A PARTICULAR PURPOSE OR MERCHANTABILITY, ARE HEREBY DISCLAIMED. MANUFACTURER SHALL NOT BE LIABLE FOR ANY SPECIAL, INDIRECT, INCIDENTAL OR CONSEQUENTIAL DAMAGES OR LOSSES, ARISING FROM ANY CAUSE OR THEORY. Since some states or countries do not allow the exclusion or limitation of an implied warranty or of incidental or consequential damages, this limitation of liability may not apply to you.

Repair

All test tools returned for warranty or non-warranty repair or for calibration should be accompanied by the following: your name, company's name, address, telephone number, and proof of purchase. Additionally, please include a brief description of the problem or the service requested and include the test leads with the meter. Non-warranty repair or replacement charges should be remitted in the form of a check, a money order, credit card with expiration date, or a purchase order made payable to Amprobe® Test Tools.

In-Warranty Repairs and Replacement – All Countries

Please read the warranty statement and check your battery before requesting repair. During the warranty period any defective test tool can be returned to your Amprobe® Test Tools distributor for an exchange for the same or like product. Please check the "Where to Buy" section on www.amprobe.com for a list of distributors near you. Additionally, in the United States and Canada In-Warranty repair and replacement units can also be sent to a Amprobe® Test Tools Service Center (see address below).

Non-Warranty Repairs and Replacement – US and Canada

Non-warranty repairs in the United States and Canada should be sent to a Amprobe® Test Tools Service Center. Call Amprobe® Test Tools or inquire at your point of purchase for current repair and replacement rates.

In USA

Amprobe Test Tools
Everett, WA 98203
Tel: 877-AMPROBE (267-7623)

In Canada

Amprobe Test Tools
Mississauga, ON L4Z 1X9
Tel: 905-890-7600

Non-Warranty Repairs and Replacement – Europe

European non-warranty units can be replaced by your Amprobe® Test Tools distributor for a nominal charge. Please check the "Where to Buy" section on www.amprobe.com for a list of distributors near you.

European Correspondence Address*

Amprobe® Test Tools Europe
In den Engematten 14
79286 Glottertal, Germany
Tel.: +49 (0) 7684 8009 - 0

*(Correspondence only – no repair or replacement available from this address. European customers please contact your distributor.)

WT-20 Conductivity TDS Meter

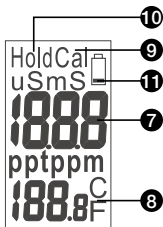
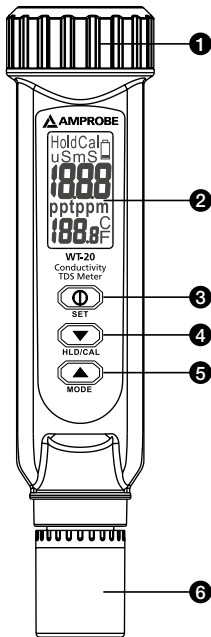

- 1) Battery Cover
- 2) Lcd Display
- 3) Power / Set Key
- 4) Hld / Cal / Down Key
- 5) Mode / Up Key
- 6) Electrode Cover
- 7) Conductivity Reading (unit: μS or mS) or TDS Reading (unit: ppt or ppm)
- 8) Display temperature in either degree Celsius or degree Fahrenheit
- 9) Calibration Mode Indicator
- 10) Freeze Display
- 11) Low Battery Indicator



POWER / SET - Power on/off, Enter setting mode (push 2 sec), Enter while in setting mode.



MODE / \blacktriangledown Key - Conductivity/TDS mode switch, Roll up while in setting mode







HLD / CAL / \blacktriangle Key - Freeze display, Calibration function, Roll down while in setting mode

CONTENTS

SYMBOLS	2
UNPACKING AND INSPECTION	2
INTRODUCTION	3
Features	3
OPERATION	3
Auto Power Off	4
Setup	5
Calibration Mode	7
Conductivity Calibration	7
TDS Calibration	9
SPECIFICATION	10
MAINTENANCE AND REPAIR	11
Battery Replacement	12
TROUBLE SHOOTING	13
Appendix A	15
Appendix B	15
Appendix C	16

SYMBOLS

	Caution! Refer to the explanation in this Manual
	Conforms to relevant Australian standards
	Complies with European Directives
	Do not dispose of this clamp meter as unsorted municipal waste. Contact a qualified recycler for disposal.

WARNING and PRECAUTIONS

- *Do not make the air bubble adhere on the electrode. That may cause inaccurate reading.*
- *Do not operate the meter in flammable liquid.*

UNPACKING AND INSPECTION

Your shipping carton should include:

- 1 WT-20 meter
- 4 LR44 battery
- 1 Manual

If any of the items are damaged or missing, return the complete package to the place of purchase for an exchange.

INTRODUCTION

Congratulations on your purchase of WT-20 Conductivity TDS meter. A convenient instrument to measure water conductivity, TDS and temperature.

Features

- IP65 Waterproof housing.
- Dual display with ATC ($^{\circ}\text{C}$ / $^{\circ}\text{F}$ switchable)
- Data hold to freeze display.
- Low battery indicator.
- Auto power off.
- One touch only for calibration.

OPERATION

1. Remove the electrode cover to expose the electrode out.
2. Press "**POWER**" to power on. LCD will display parameters (ex: tnr, tCo, tds, rAn) in turns and then enter normal display.
3. The meter is default in auto-ranging status. Press "**MODE**" key more than 2 seconds can manually select the range when the meter is in normal measurement mode.
4. Set the temperature coefficient to the right value. WT-20 is factory set to 2.1% per $^{\circ}\text{C}$. if needed, see P1.3 to set the temperature coefficient.
5. Select the normalization temperature. WT-20 is factory set to 25 $^{\circ}\text{C}$. See P1.2 to change it to 20 $^{\circ}\text{C}$.
6. Rinse the probe with deionized or distilled water before use to remove any impurities adhering to the electrode. Soak the probe more than 30 minutes to clear up the lazy effect of probe if the meter is stored for a long time.

7. Dip the probe into the sample container. Make sure no air bubbles trapped in the slot of the probe. To remove air bubbles, give the probe a gentle stir. Making sure the electrode tip is submerged when you stir it.
8. Stir the probe gently in the sample to create a homogenous sample. Allow a few seconds to reach temp. equilibrium. Wait about 15 minutes can get a stable reading.
9. The unit of conductivity will flash on the LCD to indicate the meter is in measurement mode. When the reading is stable, the unit will stop flashing. (Fig1)
10. Press "**HLD**" to freeze display. "Hold" will appear on the LCD. (Fig.2) Press "**HLD**" again to release.
11. TDS Measurement:
In measurement mode, press "**MODE**" to switch to DS mode. The unit of conductivity are uS or mS. The unit of TDS are ppm or ppt.
Set the TDS conversion factor to right value. The factory default is 0.50 To change the TDS factors, refer Appendix A.
12. Turn off the meter by pressing "**POWER**" key.

Auto Power Off

This meter will shut off automatically 20 minutes of inactivity. To disable the auto power off, pressing "**SET**" + "**HLD**" keys simultaneously while turning on the meter until a "**n**" appeared on the screen and then release keys to return to normal mode.(Fig.3)

Setup

The advanced setup mode lets you customize your meter. 4 types parameter are available.

P1.0: temperature parameter setting (t)

P1.1: Change temperature unit (tUt)

P1.2: Normalization temp.(tnr)

P1.3: Temp. Coefficient (tCo)

P2.0: TDS factor setting

P2.1: Setting TDS factor (tds)

P3.0: Reset meter (rSt)

P3.1: Reset

P4.0: Review Calibration Info. (CAL)

P4.1: Review range 1 calibration information

P4.2: Review range 2 calibration information

P1.1: Change temperature unit (tUt):

1. When in measurement mode, press "SET" more than 2 sec to enter setup mode. Press "▼" or "▲" to select P1.0, press "SET" to enter or press "SET" for more than 2 seconds to quit.
2. Press "▲" to select C or F.
3. Press "SET" to confirm or press "SET" more than 2 sec to return to P1.0 without saving.

P1.2: Normalization temp.(tnr):

After saving temp. unit, the meter will automatically enter normalization temp. adjustment. Press "▲" to change the temperature to 20°C or 25°C. Press "SET" to confirm and or press "SET" more than 2 sec to return to P1.0 without saving.

P1.3: Temp. Coefficient (tCo)

In temp. coefficient adjustment, press "▼" or "▲" to change the temperature coefficient from 0.0 to 4.0. Press "SET" to confirm or press "SET" more than 2 sec to return to P1.0 without confirming.

P2.1: Setting TDS factor(tds):

In P2.0, press "SET" to enter P2.1. The factor will flash on LCD. Press "▼" or "▲" to change factor from 0.40 to 1.00. Press "SET" to confirm or press "SET" more than 2 seconds to return to P2. 0 without saving.

P3.1: Reset

After executing, all parameters will be reset to factor default. The previous calibration information will be cleared as well.

In P3.0, press "SET" to enter P3.1. Press "▲" to select Y or N. Press "SET" to confirm or press "SET" more than 2 seconds to return without confirming.

P4.1: Range 1 calibration info:

In P4.0, press "SET" to enter P4.1 and review the last calibration concentration. If the meter is not yet calibrated, "---" will display on the LCD. The calibration information will be override after recalibration.

P4.2: Range 2 calibration info:

In P4.1, press "▲" to enter P4.2 and review the last calibration concentration. If range 2 is not yet calibrated, "---" will display on LCD. In P4.1 or P4.2, press "SET" to return to P4.0.

Calibration Mode (CAL)

Selecting a calibration standard

For best results, select a conductivity or TDS standard near the sample value you are measuring. Alternatively, use a calibration solution value which is approximate 2/3 of the full scale of the measurement range you plan to use. For example, in the 0 to 1999 μS range, use 1413 μS solution for calibration.

DO NOT reuse the calibration solution. Contaminants in the solution will affect the calibration and the accuracy

When to do the calibration?

Calibration is necessary and should be done regularly.

If measure the mid-ranges, calibrate the meter at least once a month. Soak the probe for 15 mins before calibration or measurement can saturate the probe surface and minimize drift.

If measure the extreme temperatures or special concentration ($<100\mu\text{S}$ or $>2\text{mS}$), calibrate the meter at least once a week to get specified accuracy

Conductivity calibration

1. Dip the probe into demineralized or distilled water for about 30 minutes to rinse the probe.
2. Select the conductivity standard for calibration.
3. Pour enough solution into two separate clean containers.
4. Power on the meter. Select the mode as conductivity measurement mode.
5. Rinse the probe into one of above containers. Gently stir the probe.

6. Dip the rinsed probe into the second container. Tap probe on the bottom of container to remove air bubbles. Wait about 15 mins to make the probe stabilize to the solution temperature.
7. Press "**CAL**" more than 2 seconds to begin calibration. The conductivity value of solution will blink on LCD.
8. Press "**▲**" and "**▼**" to change the value in order to match the value to the standard solution(solution must be referred to normalization temp. 20oC if P1.2 is adjusted as 20 oC). You can adjust the conductivity reading for +30%. However, if the measured value and standard value differs by more than 30%, it is suggested to clean probe or replace meter.
9. When the "**CAL**" stop flashing, you can press "**SET**" less than 1 second to confirm and return to conductivity measurement mode. If "**CAL**" always blinks, check if the calibration solution is stable enough and if the step 8 input value is correct or not.
10. Repeat 1~9 for other ranges if needed.
11. To exit conductivity calibration mode without confirming, press "**SET**" in step 9 more than 2 seconds.

TDS Calibration

Option1: Using TDS standards

1. Insert the probe into demineralized or distilled water for about 30 minutes to rinse the probe
2. Select the TDS standard for calibration. The factory default setting of the TDS conversion factor is 0.50. You can improve the calibration accuracy by setting the TDS factor before starting the calibration. Please refer Appendix A for more information of TDS conversion factor.
3. Pour enough solution into two separate & clean containers.
4. Turn on the meter. Press "**MODE**" to select TDS mode.
5. Rinse the probe into one of the containers. Gently stir the probe.
6. Dip the rinsed probe into the second container. Tap the probe on the bottom of container to remove air bubbles. Let the probe stabilize to the solution temperature.
7. Press "**CAL**" more than 2 seconds to begin the calibration. The TDS value will blink on the LCD.
8. Press the "**▼**" to adjust the value to match the value to the standard solution.
9. When "**CAL**" stop flashing, press "**SET**" to confirm and return to TDS normal mode.
10. Repeat 1~9 for other ranges if needed.

Option2: Using Conversion Factors

TDS values are related to conductivity. You can calibrate the meter by using conductivity standards as described above and then program the meter with a given conversion factor. Please refer to setting P2.1

SPECIFICATION

Range : 0~1999 μ S/0~1999ppm
or 0~19.99mS/0~19.99ppt

Resolution : 1 μ S/ppm or 0.01mS/ppt

Accuracy : 1% Full Scale \pm 1digit

TDS factor : 0.40~1.00

Calibration Standard : (0.2~1) * Full Scale
Range

ATC : 0~50°C

Temperature Accuracy : \pm 0.5°C

Temp. Coefficient : 0~4.0% per degree C

Normalization Temp. : 20 or 25°C

Operation temp. : 0~50°C

Power Requirements : 4pcs1.5V(Type: A76 or LR44)

CE - EMC: Conforms to EN61326-1.

This product complies with requirements of the following European Community Directives: 89/ 336/ EEC (Electromagnetic Compatibility) and 73/ 23/ EEC (Low Voltage) as amended by 93/ 68/ EEC (CE Marking). However, electrical noise or intense electromagnetic fields in the vicinity of the equipment may disturb the measurement circuit. Measuring instruments will also respond to unwanted signals that may be present within the measurement circuit. Users should exercise care and take appropriate precautions to avoid misleading results when making measurements in the presence of electronic interference.

MAINTENANCE AND REPAIR

If there appears to be a malfunction during the operation of the meter, the following steps should be performed in order to isolate the cause of the problem.

1. Check the battery. Replace the battery immediately when the “” symbol appears on the LCD.
2. Review the operating instructions for possible mistakes in operating procedure.

Except for the replacement of the battery, repair of the meter should be performed only by a Factory Authorized Service Center or by other qualified instrument service personnel. The front panel and case can be cleaned with a mild solution of detergent and water. Apply sparingly with a soft cloth and allow to dry completely before using. Do not use aromatic hydrocarbons or chlorinated solvents for cleaning.

Make sure the electrode is clean! Between measurements, rinse the electrode with deionised water. If the electrode has been exposed to a solvent immiscible with water, clean it with a solvent miscible with water e.g. ethanol or acetone and rinse carefully with water.

Store the electrode carefully! Before storing, rinse it carefully in deionized water and store **DRY**.

BATTERY REPLACEMENT

1. Turn off the meter and loose the battery cover in counter-clockwise direction.
2. Replace the old batteries with four new LR44 button cells.
3. Put back the battery cover and turn it tightly. the Red LED Low Battery indicator illuminates. The batteries should be replaced as quickly as possible.

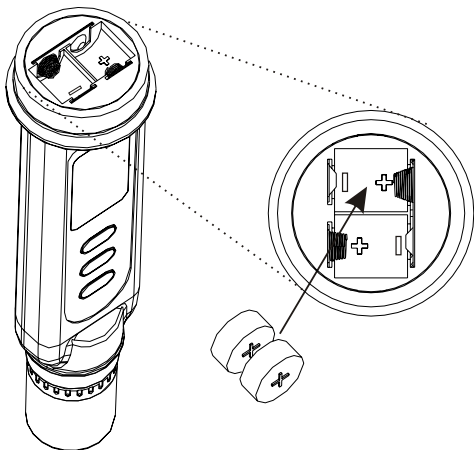

TROUBLE SHOOTING

Power On But No Display

- Make sure you press power key more than 100 mS.
- Check the battery conditions and replace if necessary
- Move batteries away for one minute and then re-install.

Display Disappear

- Check whether the low battery icon is appeared before the display is off. If yes, replace with new batteries

Air Bubbles Adhere On Electrode

- Stir the electrode completely and better to dip the electrode into solution at oblique angle. After soaking the electrode for 15~30 minutes, inspect the electrode carefully to make sure no bubbles adhere.
- If air bubbles still exist, tap the bottom of the container gently and stir the electrode to remove the air bubbles. If above method are not working, remove the electrode out of solution and blow at the electrode to remove the air bubbles

Error Code

Parameter: Conductivity	
"- - -"	Meter is in manual range 1 however the measured value is higher than 1999uS. <ul style="list-style-type: none">• Press "▲" more than 2 seconds to change the range to range 2 or to auto ranging.

"E03"	<p>Conductivity value is over the range limit (19.99mS) or meter is damaged.</p> <ul style="list-style-type: none"> • Put the meter in standard solution. If E03 still appears, send back for repair.
"E04"	<p>Caused by temp. reading error</p> <ul style="list-style-type: none"> • Refer to error code of temp. After solving the error of temp, E04 will disappear.

Parameter: TDS	
"- - -"	<p>Meter is in manual range 1 however the measured value is higher than 1999*TDS factor ppm</p> <ul style="list-style-type: none"> • Press "▲" more than 2 seconds to change the range to range 2 or to auto ranging.
"E04"	<p>Caused by temp. or conductivity error</p> <ul style="list-style-type: none"> • Refer to error code of temp. After solving the error of temp. & conductivity, E04 will disappear.

Parameter: Temperature	
"E01"	<p>Temperature circuit is damaged</p> <ul style="list-style-type: none"> • Send back for repair
"E02"	<p>Temp value is lower than range limit (0°C) or temp. circuit is damaged</p> <ul style="list-style-type: none"> • Put the meter in room temp. for 5 mins. If E02 still appears, send back for repair.
"E03"	<p>Temp value is higher than range limit (50°C) or temperature circuit is damaged</p> <ul style="list-style-type: none"> • Put the meter in room temp. for 5 mins. If E02 still appears, send back for repair

Appendix A: Conductivity to TDS Conversion Factors

Conductivity at 25 °C	TDS KCL		TDS (NaCL)		TDS (442)	
	ppm	Factor	ppm	Factor	ppm	Factor
23µS	11.6	0.5043	10.7	0.4652	14.74	0.6409
84µS	40.38	0.4807	38.04	0.4529	50.5	0.6012
447µS	225.6	0.5047	215.5	0.4822	300	0.6712
1413µS	744.7	0.527	702.1	0.4969	1000	0.7078
1500µS	757.1	0.5047	737.1	0.4914	1050	0.7
2070µS	1045	0.5048	1041	0.5029	1500	0.7246
2764µS	1382	0.5	1414.8	0.5119	2062.7	0.7463
8974µS	5101	0.5685	4487	0.5	7608	0.8478
12,880µS	7447	0.5782	7230	0.5613	11,367	0.8825
15,000µS	8759	0.5839	8532	0.5688	13,455	0.897
80mS	52,168	0.6521	48,384	0.6048	79,688	0.9961

442: 40% sodium sulfate, 40% sodium bicarbonate and 20% sodium chloride

Appendix B: Calculating TDS Conversion Factors

The meter can be calibrated using TDS calibration standard solutions. The calibration standard only needs to give the TDS value at a standard temperature such as 25°C. To determine the Conductivity-to-TDS conversion factor use the following formula:

$$\text{Factor} = \text{Actual TDS} \div \text{Actual Conductivity @ 25°C}$$

Definitions

Actual TDS: Value from the solution bottle label or as a standard you make using high purity water and precisely weighed salts.

Actual Conductivity: Value measured using a properly calibration Conductivity/TDS/Temperature meter. Both the actual TDS and the actual conductivity values must be in the same magnitude of units. For example, if the TDS value is in ppm, the conductivity value must be in μS ; if the TDS value is in ppt, the conductivity value must be in mS. Check this number by multiplying the conductivity reading by the factor in the above formula and the result is the TDS in ppm.

Appendix C: Temperature Effect

Conductivity measurements are temperature dependent, if the temperature increases, conductivity increases. For example the conductivity measured in a 0.01M KCl solution at 20°C is 1.273 mS/cm whereas, at 25°C, it is 1.409 mS/cm.

The concept of reference temperature (Normalization temperature) was introduced to allow the comparison of conductivity results obtained at different temperature. The reference temperature is usually 20°C or 25°C. The conductivity meter measures the actual conductivity and temperature and then converts it to the reference temperature using a temperature correction function and displays the conductivity at the reference temperature.

It is mandatory to always associate the temperature together with a conductivity result. If no temperature correction is applied, the conductivity is the value taken at measurement temperature.

The WT-20 use linear temperature correction.

Linear temperature correction:

In moderately and highly conductive solutions, temperature correction can be based on a linear equation involving a temperature coefficient (θ). The coefficient is usually expressed as a conductivity variation in % / °C.

Linear temperature correction is used, e.g. for saline solutions, acids and leaching solutions.

$$K_{T_{ref}} = \frac{100}{100 + \theta \cdot (T - T_{ref})} \cdot K_T$$

Where:

$K_{T_{ref}}$ = Conductivity at Tref

K_T = Conductivity at T

Tref = Reference temperature

T = Sample temperature

θ = Temperature coefficient

Note: the correction is accurate only within a limited temperature range around T1 and T2. The greater the difference between T and Tref, the higher the risk of error.

Calculating Temperature Coefficients (θ)

By measuring the conductivity of a sample at temperature T1 close to Tref and another temperature T2, you can calculate the temperature coefficient by using the following equation:

$$\theta = \frac{(K_{T_2} - K_{T_1}) \cdot 100}{(T_2 - T_1) \cdot K_{T_1}}$$

T2 should be selected as a typical sample temperature and should be approximately 10°C different from T1. The temperature coefficients of the following electrolytes generally fall into the ranges shown below:

- Acids: 1.0 - 1.6% / °C
- Bases: 1.8 - 2.2% / °C
- Salts: 2.2 - 3.0% / °C
- Drinking water: 2.0% / °C
- Ultrapure water: 5.2% / °C

Average temperature coefficients of standard electrolyte solutions expressed as %/°C of the conductivity value at 25°C

Temp. range °C	KCl 1 M	KCl 0.1 M	KCl 0.01 M	Saturated NaCl
15-25	1.725	1.863	1.882	1.981
15-25-35	1.730 (15 - 27°C)	1.906	1.937 (15 - 34°C)	2.041
25-35	1.762 (25 - 27°C)	1.978	1.997 (25 - 34°C)	2.101

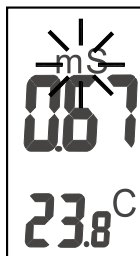

Figur 1.



Figur 2.



Figur 3.

Visit www.Amprobe.com for

- Catalog
- Application notes
- Product specifications
- User manuals



Please Recycle